

Supplementary Figure 1

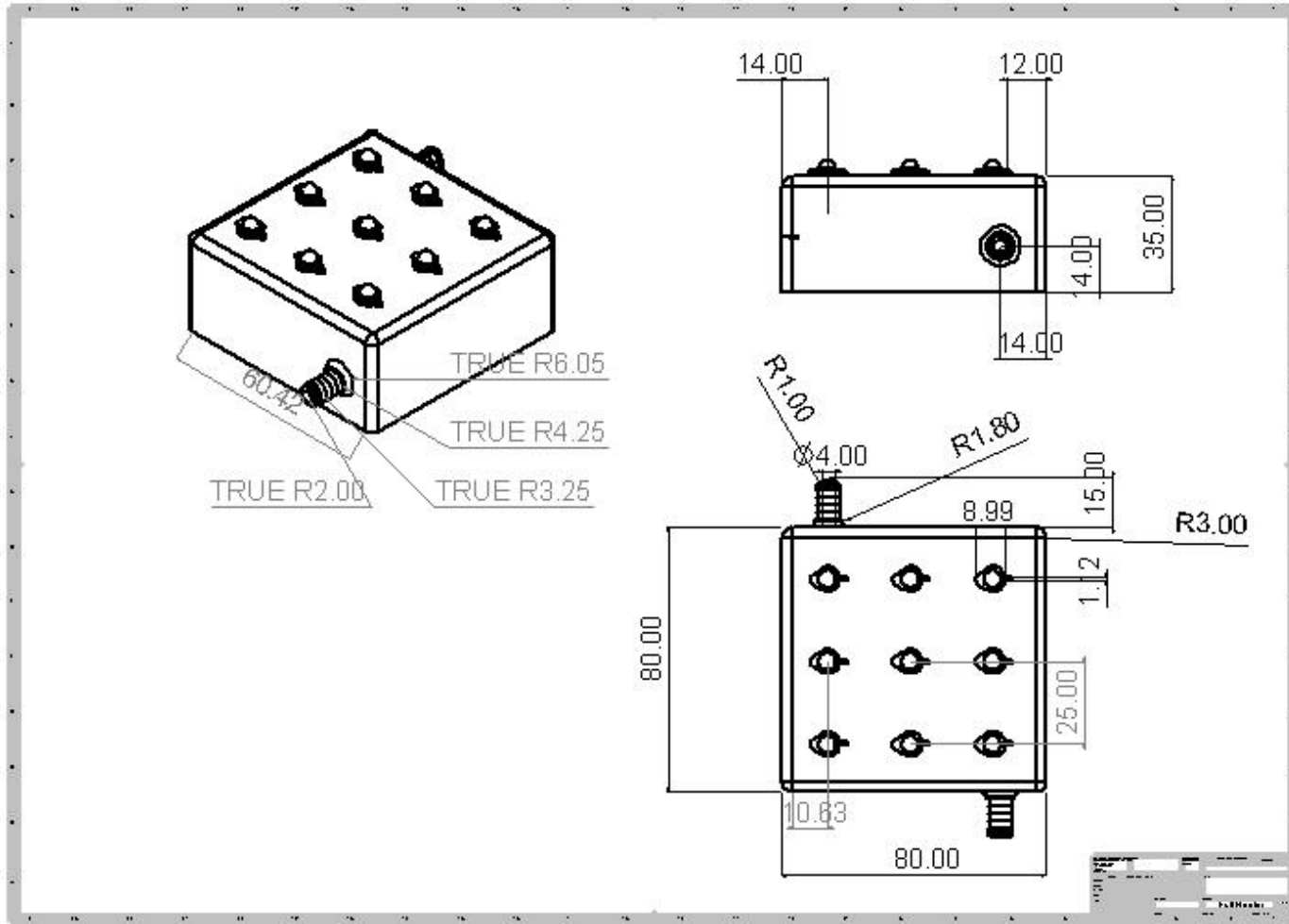

Supplementary Figure 2

Positive Control: 2019-nCoV_N

Created with SnapGene®

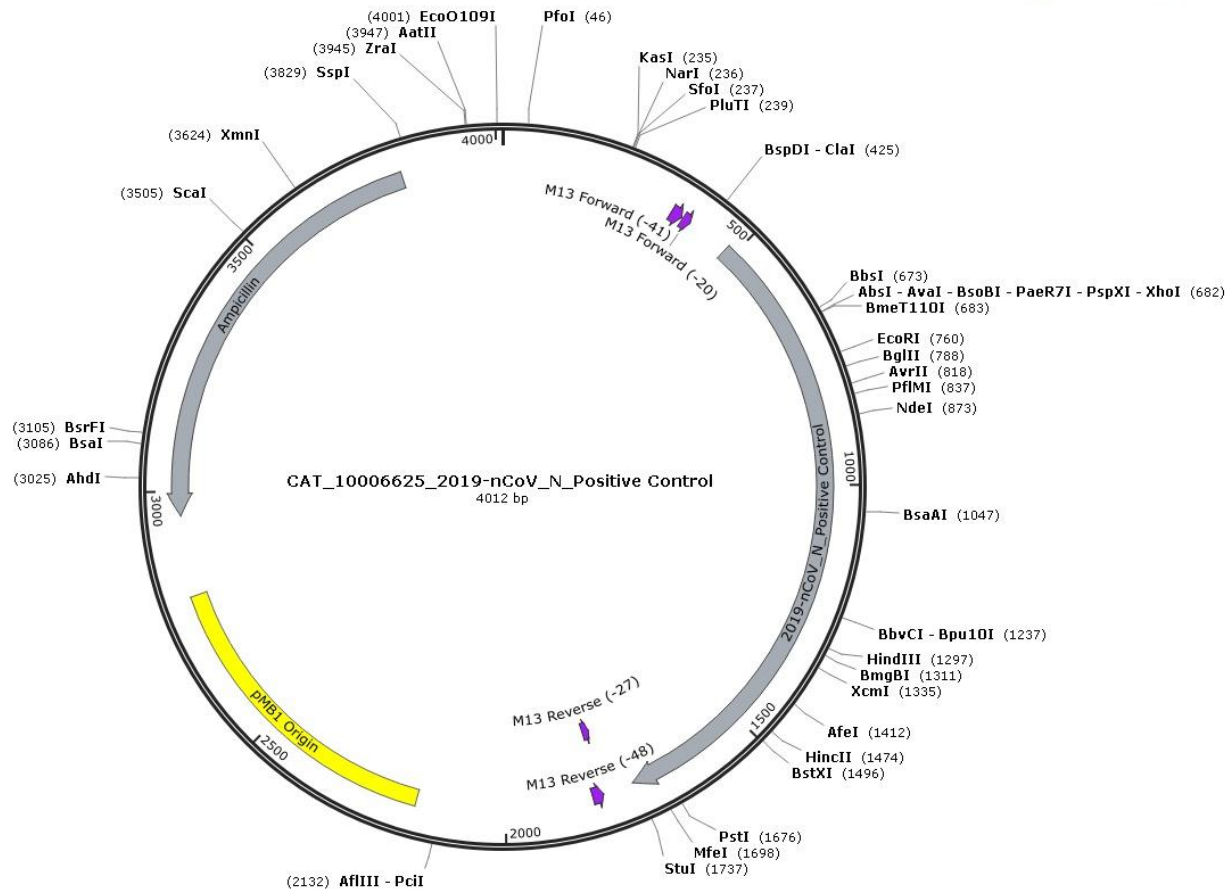

Supplementary Figure 3

Negative Control: GP EBOV

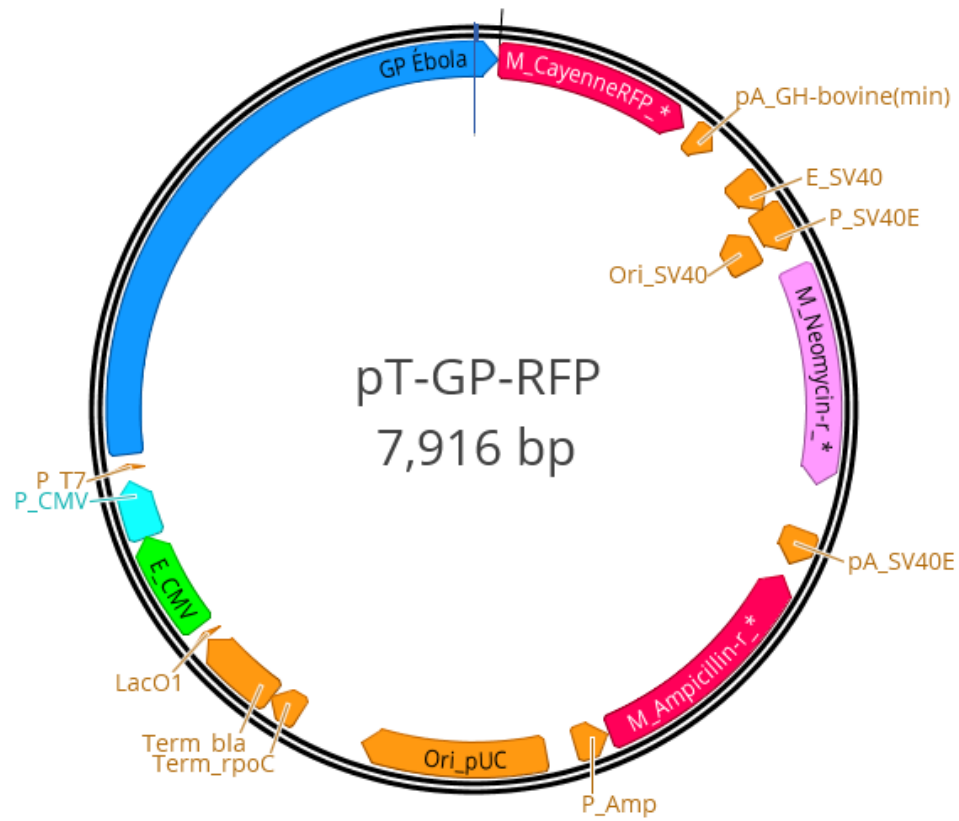

Supplementary Figure 4

A

Set α

Set β

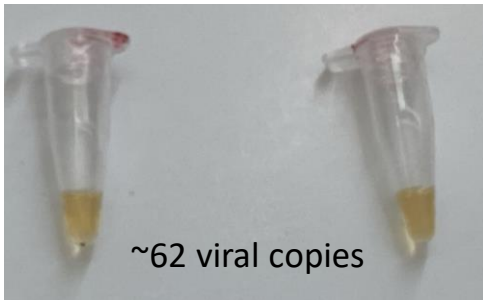

B

Storage temperature

4 °C

20 °C

Storage time (days)

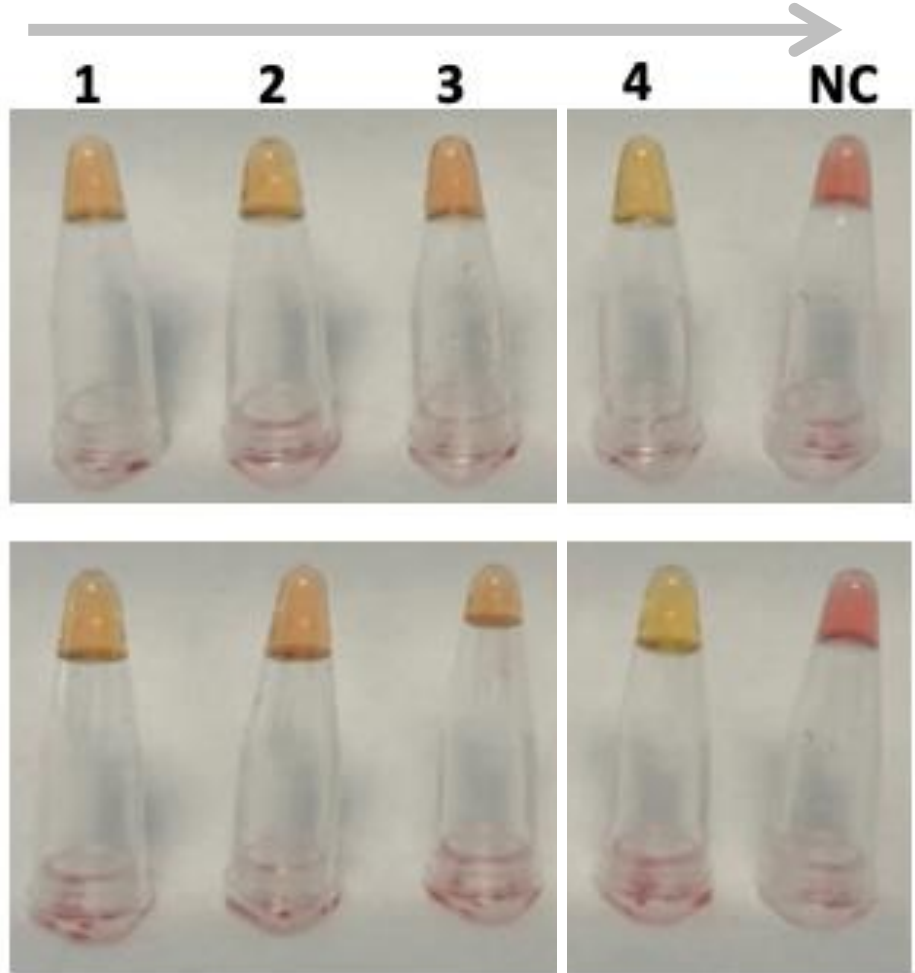

Supplementary Figure 5

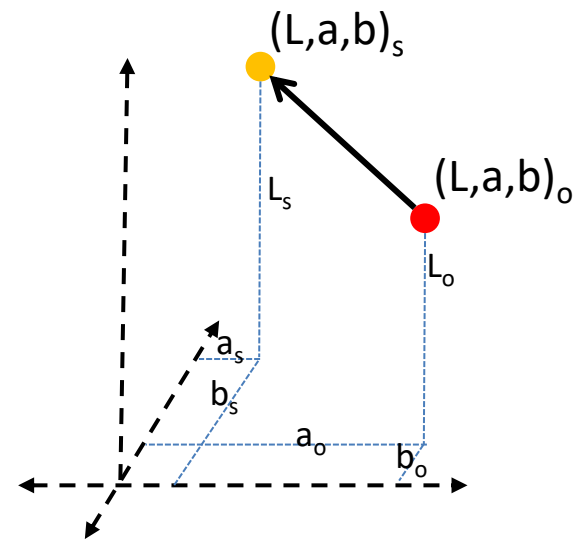
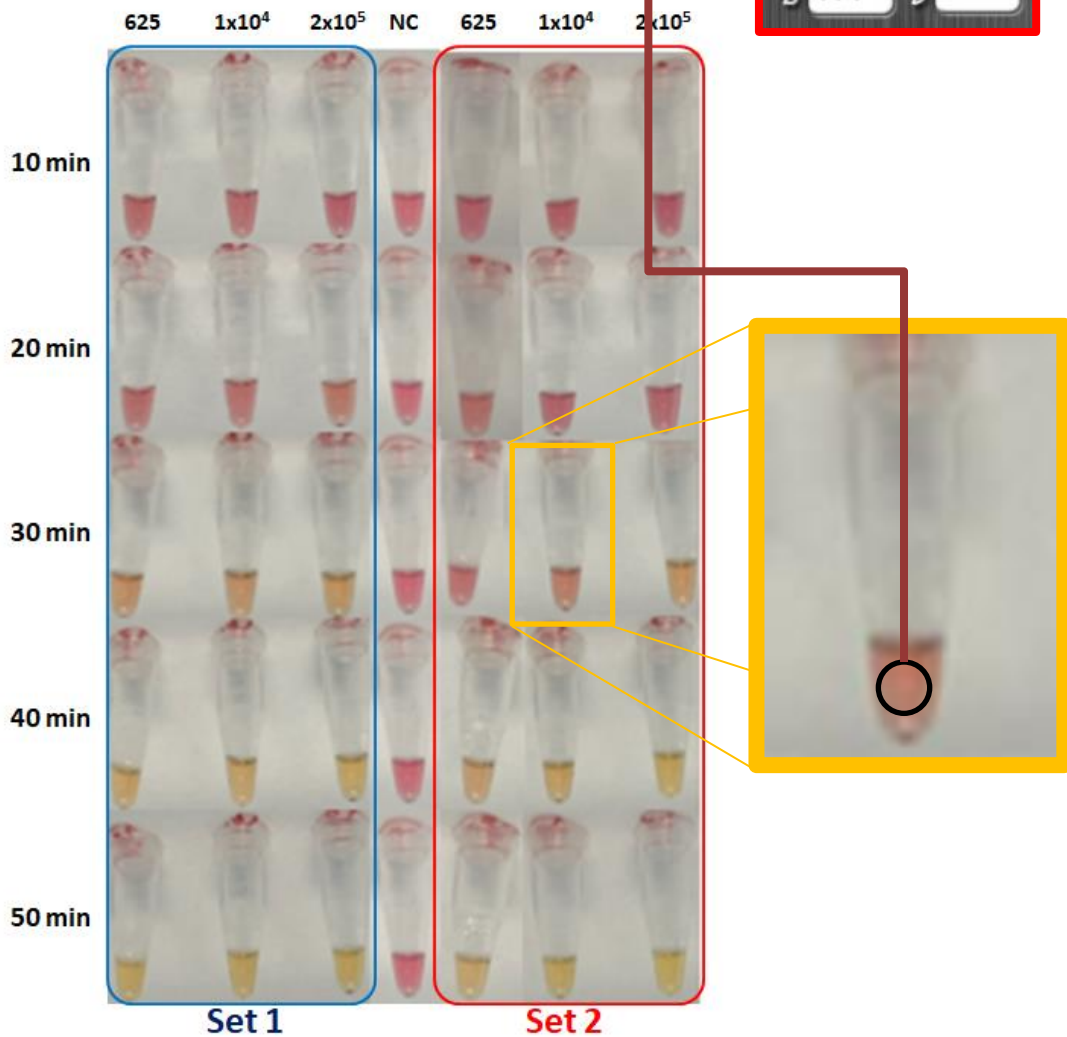
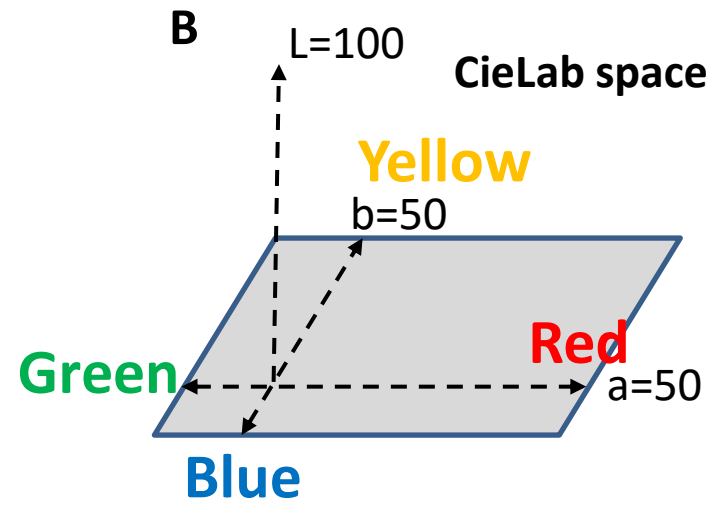
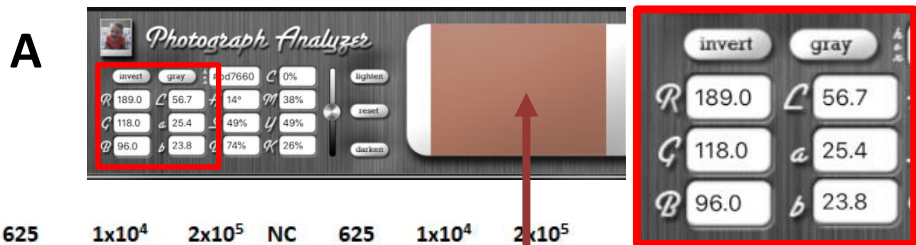

Supplementary Figure 6

A



B

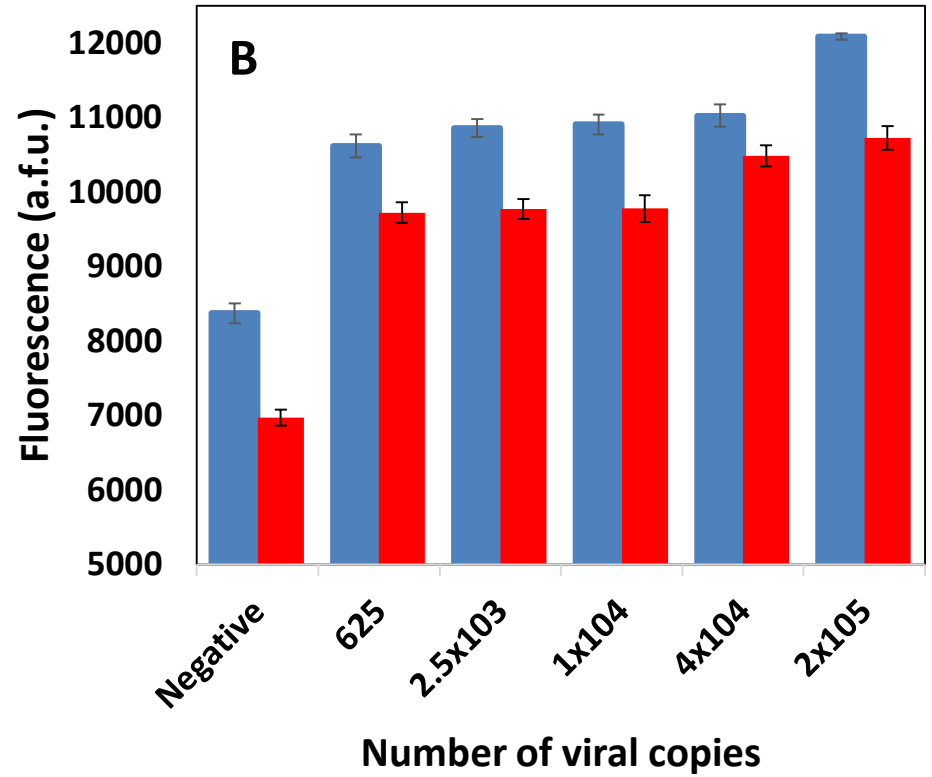

Supplementary Figure 7