

Supplementary Figure 1

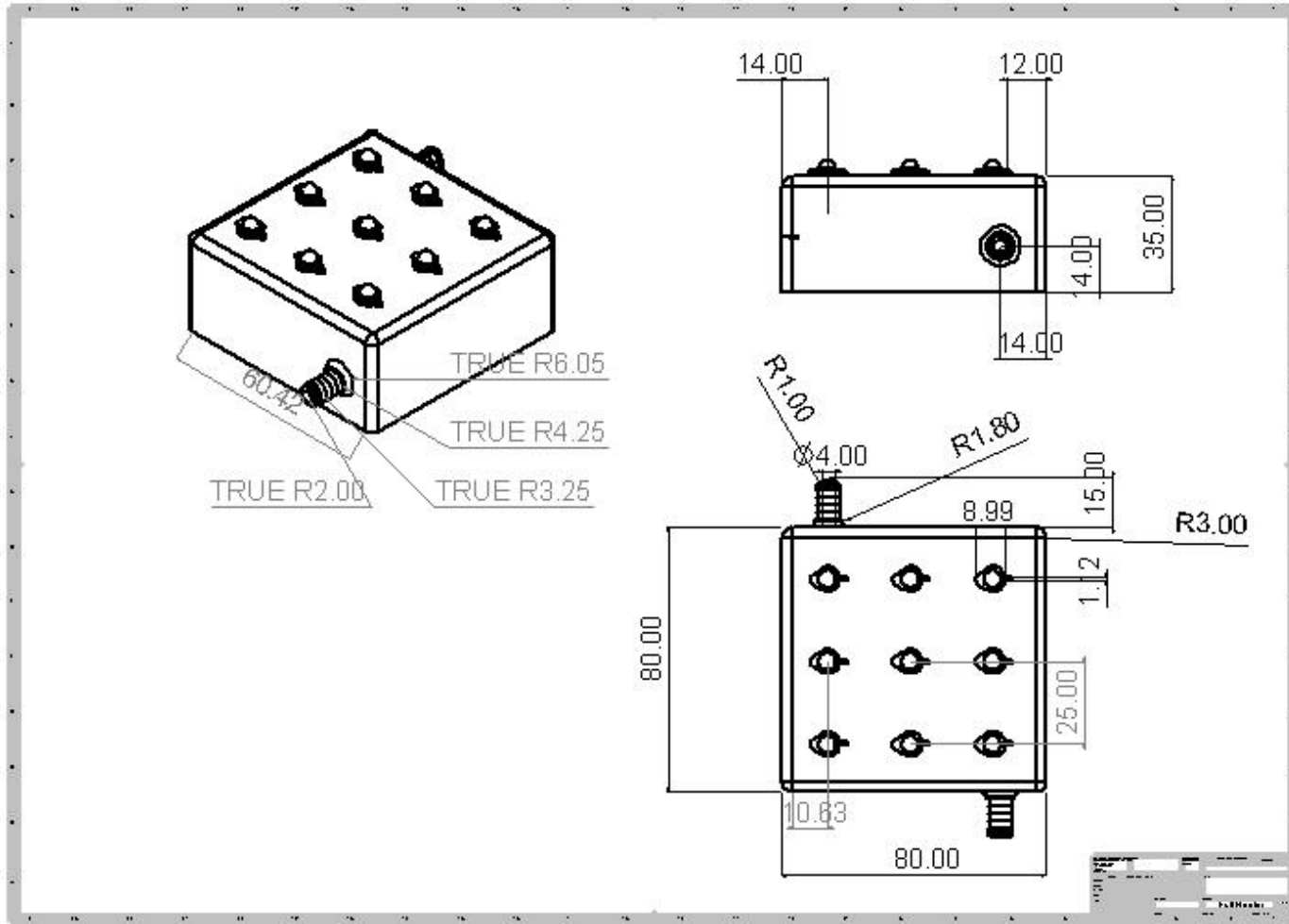

Supplementary Figure 2

A

Set α

Set β

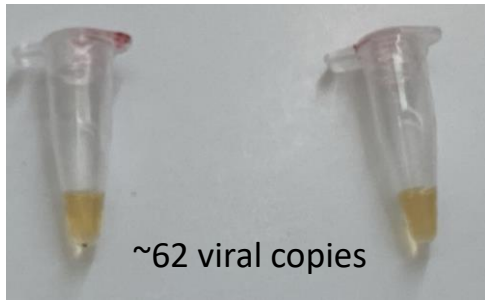

B

4 °C

20 °C

negative

positive

positive

Storage time

24

48

72

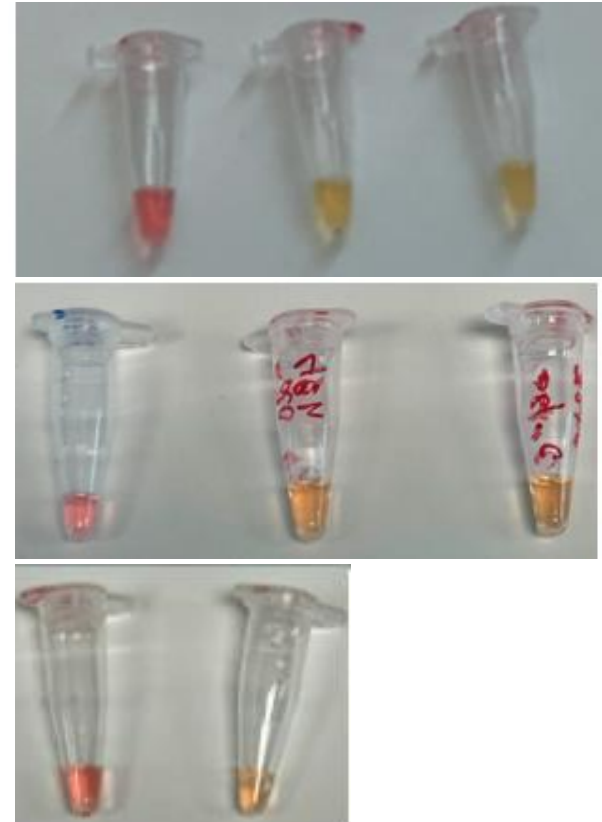

Supplementary Figure 3

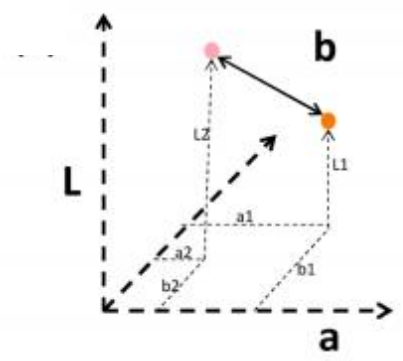
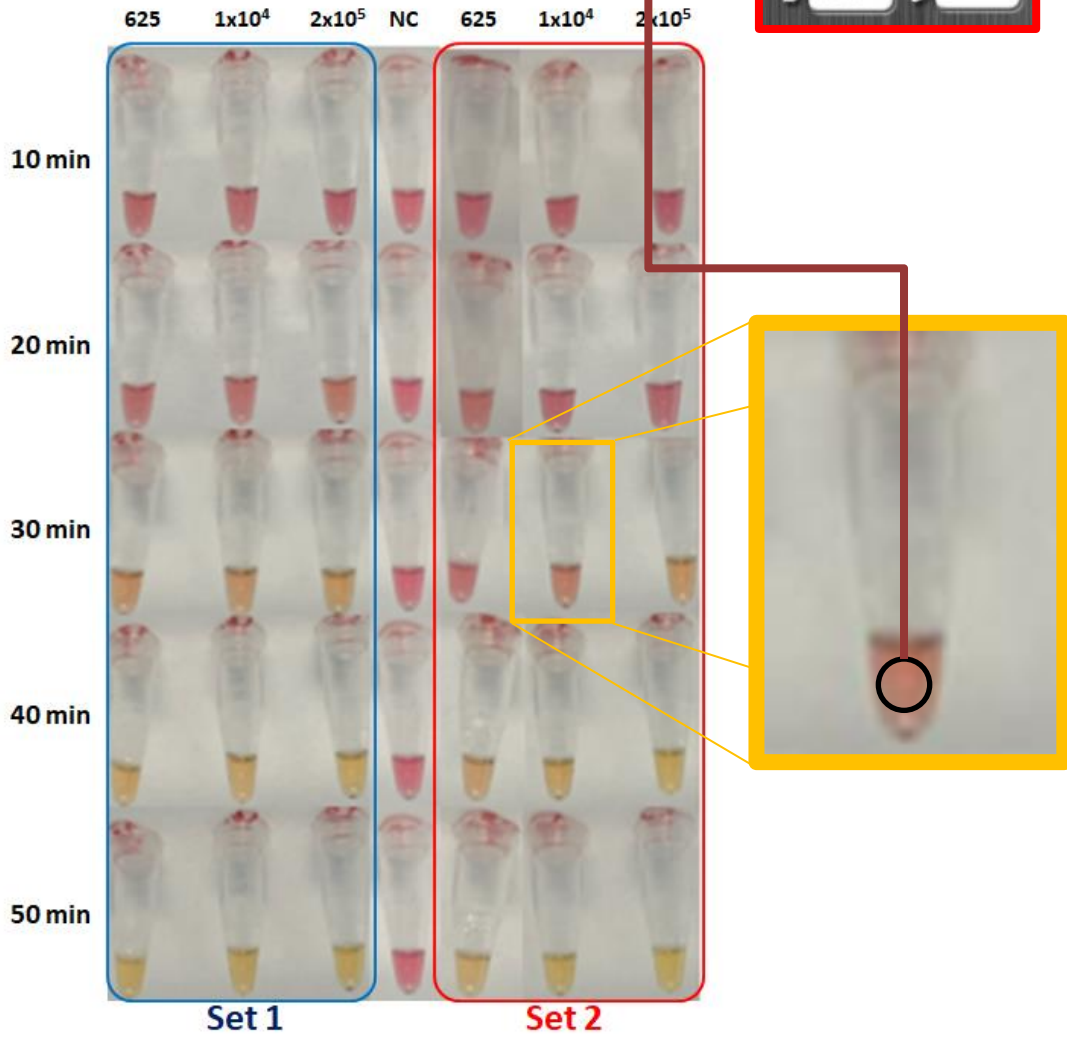
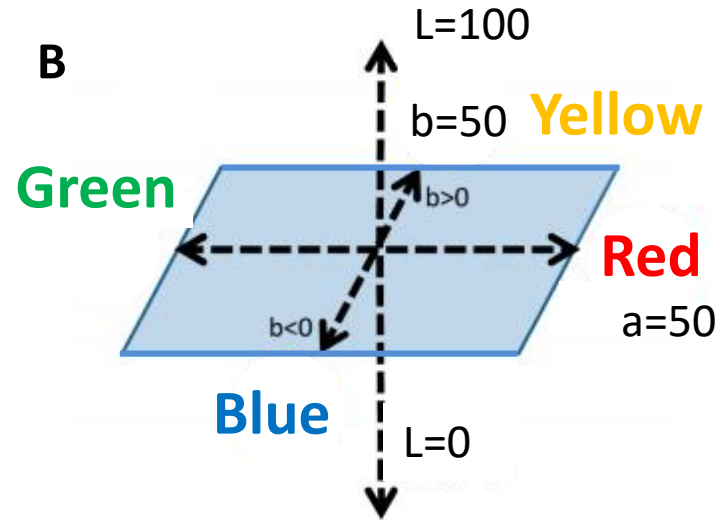
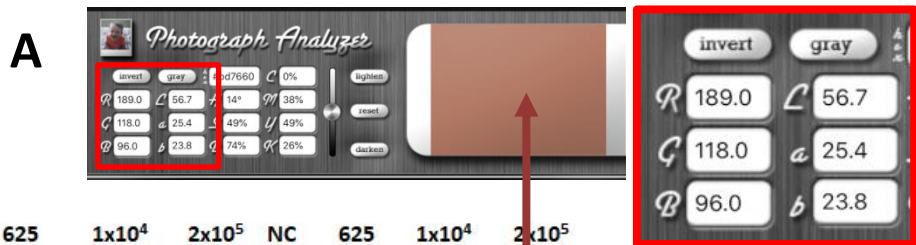

Supplementary Figure 4

A

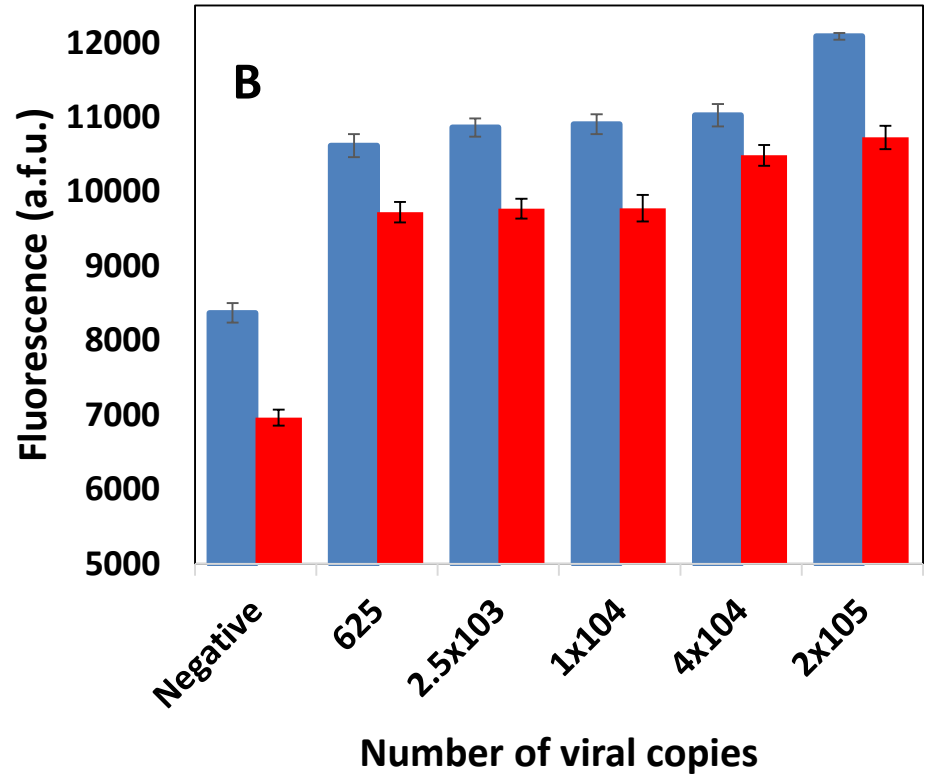

Supplementary Figure 5