

Supplementary Figure 1

A

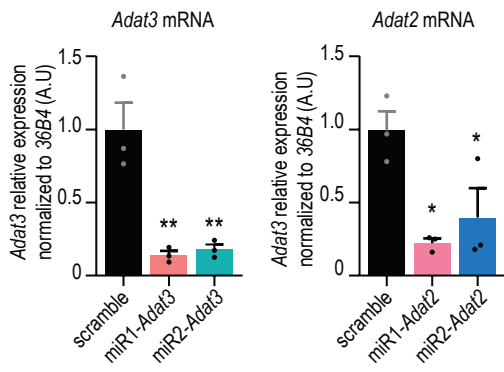

B

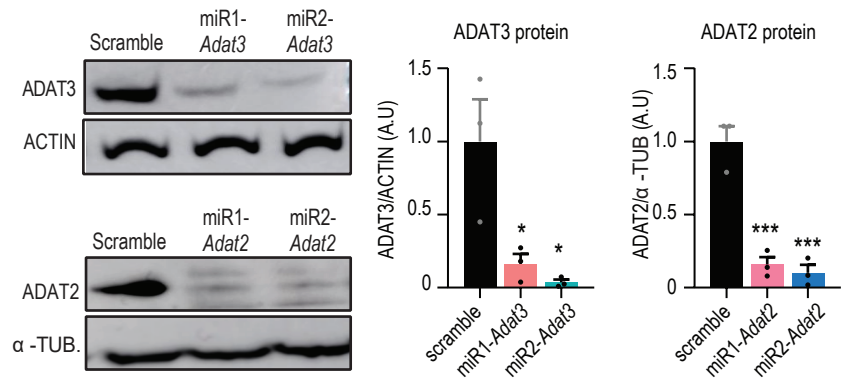

C

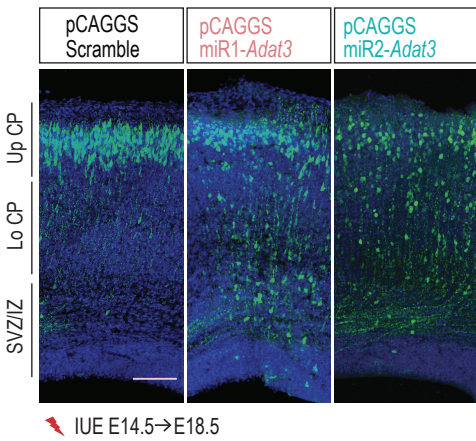

D

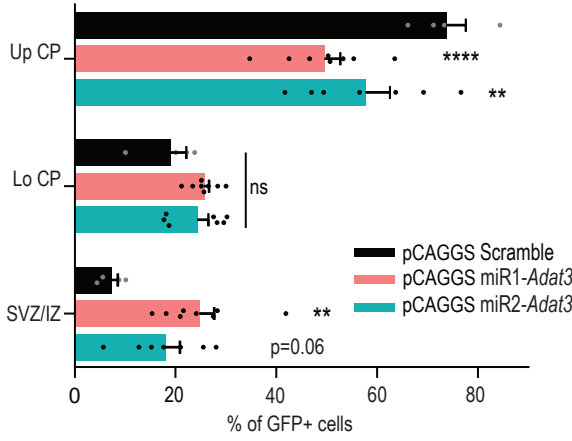

E

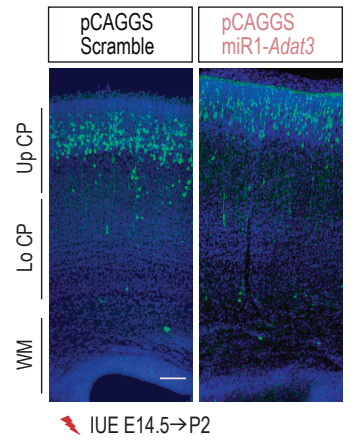

F

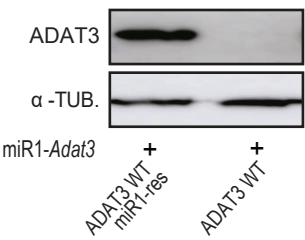

G

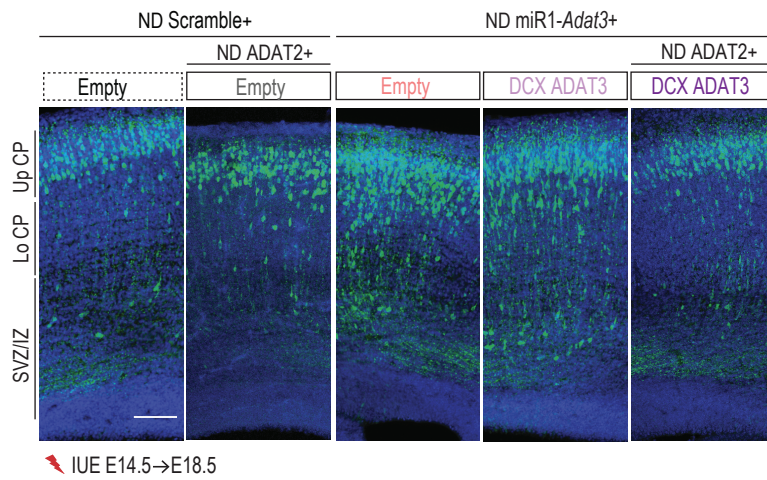

H

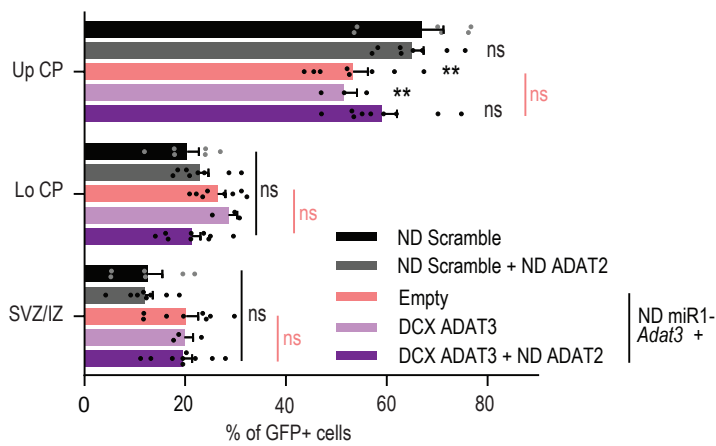

I

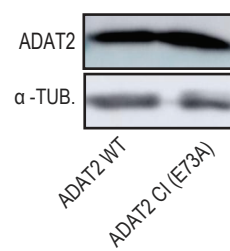

Supplementary Figure 2

A



B

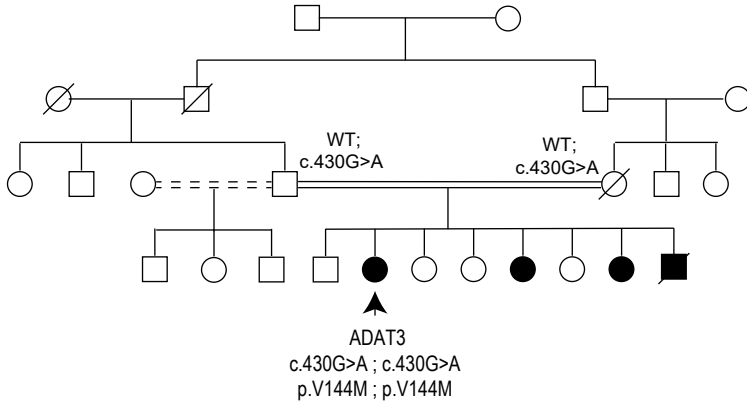

C

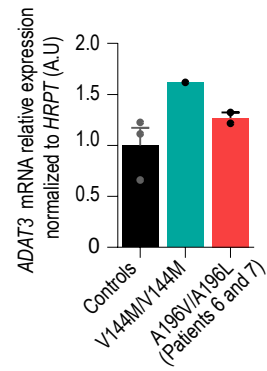

D

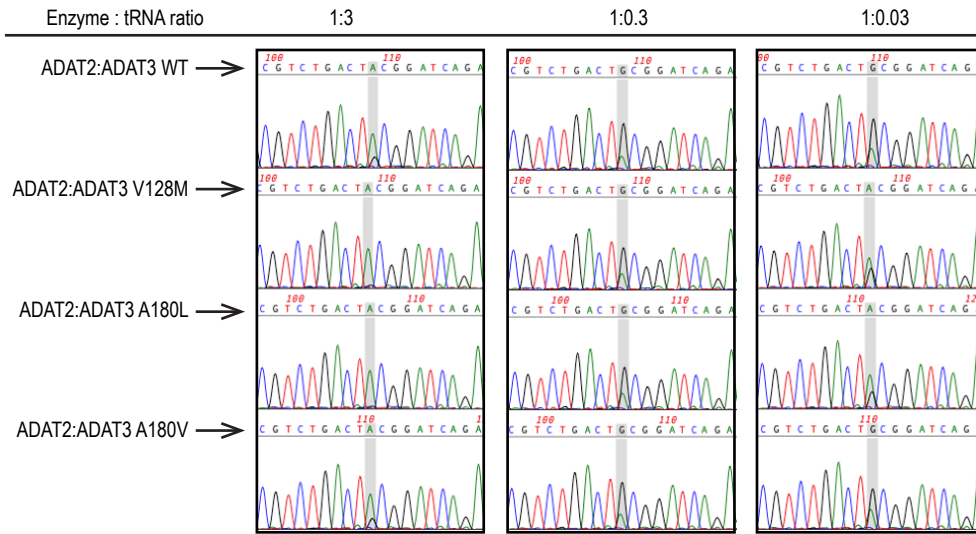

Supplementary Figure 4

A

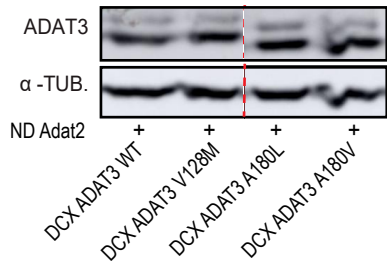

B

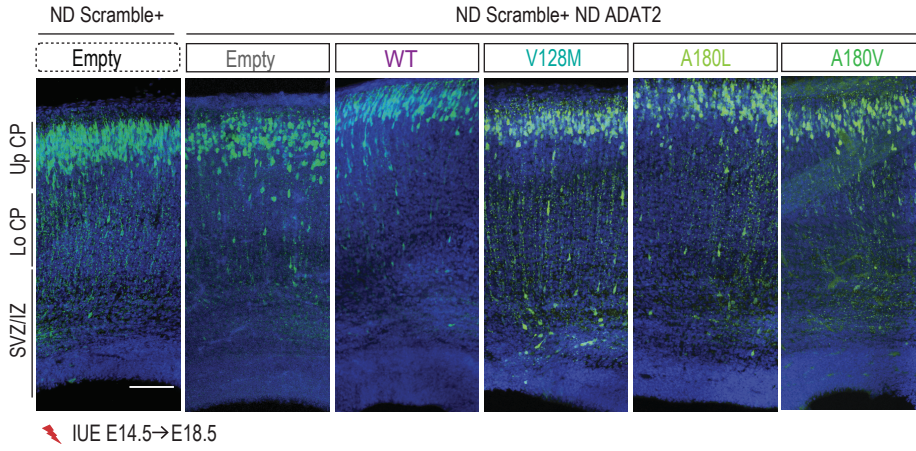

C

