

ADHDxCU GWAS

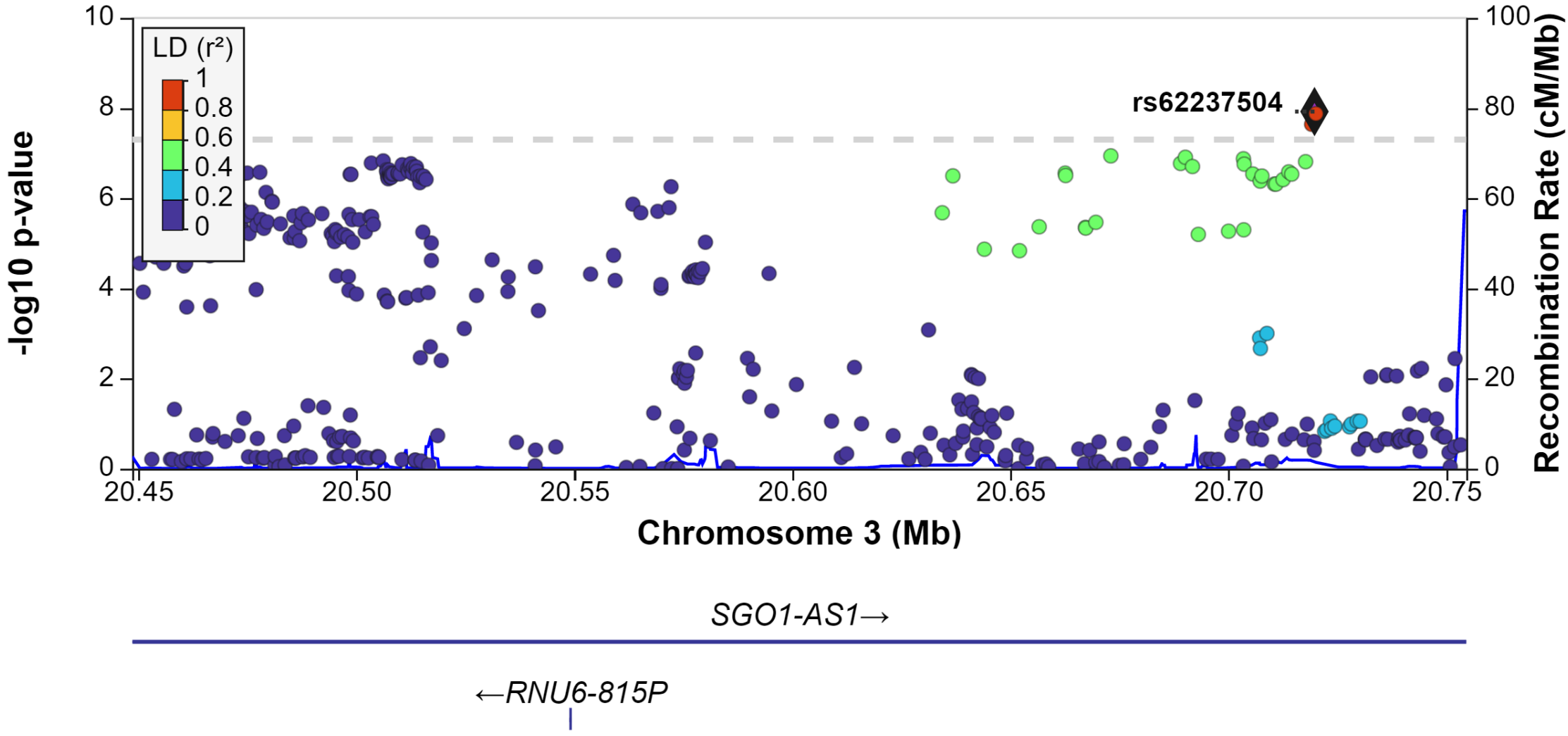

ADHDxCU GWAS

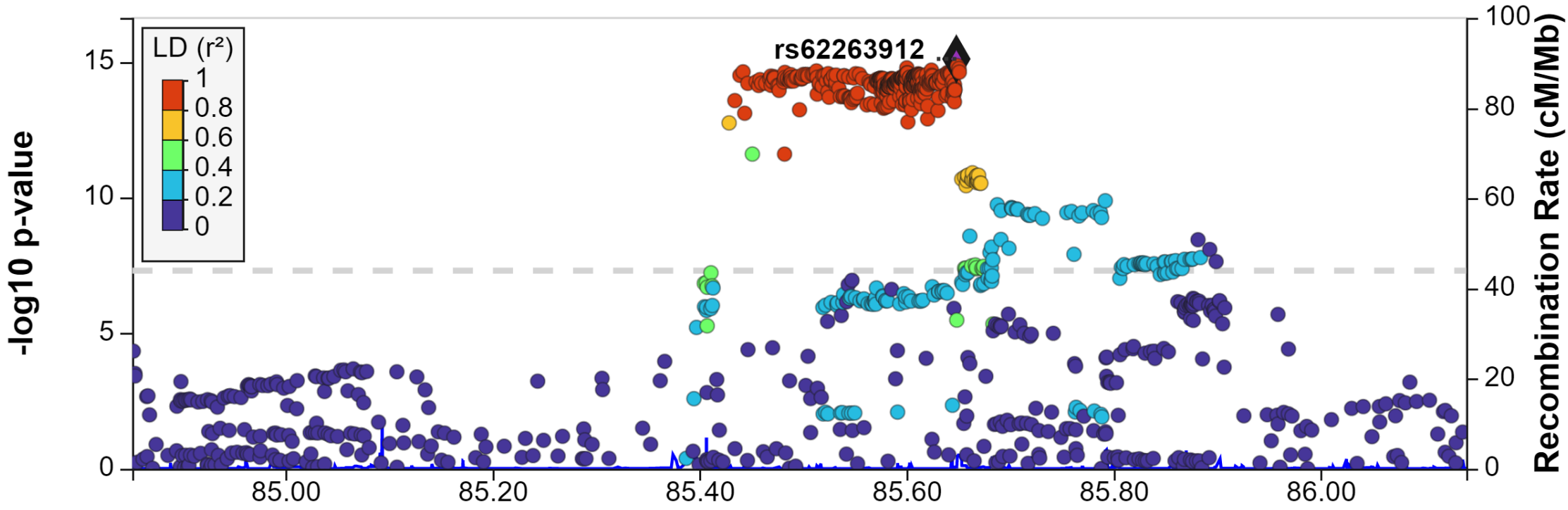

← *LINC00971*

MIR5688 →

← *CADM2-AS2*

LINC02025 →

← *CADM2-AS1*

AC132660.1 →

THAP12P2 →

AC132660.2 →

CADM2 →

ADHDxCU GWAS

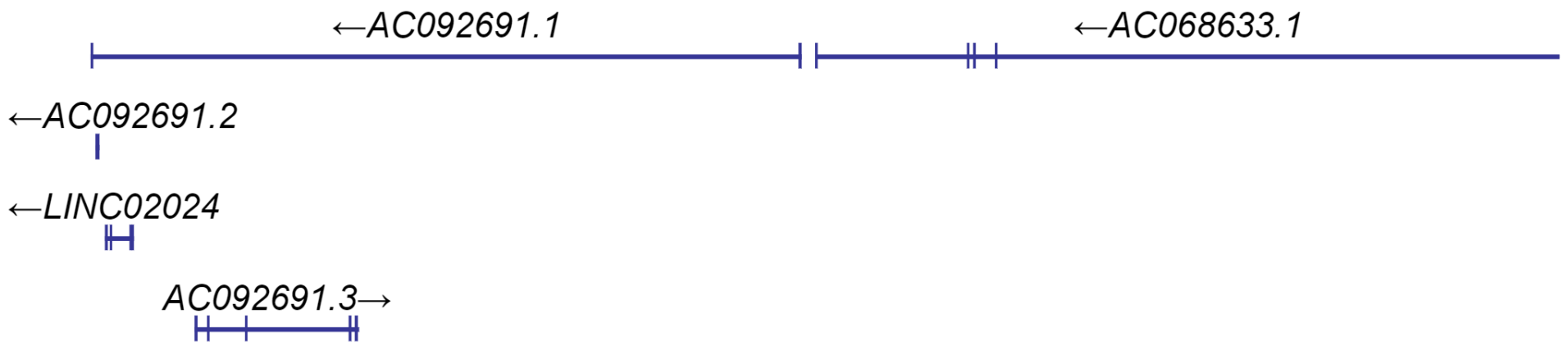
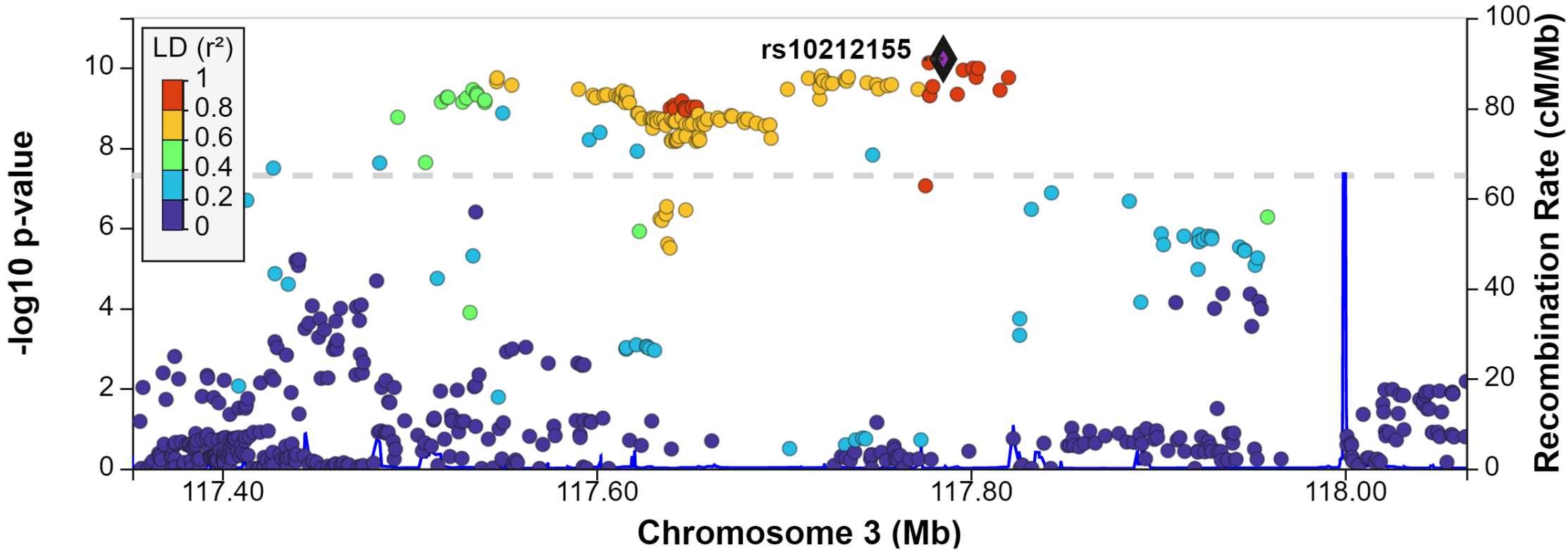

ADHDxCU GWAS

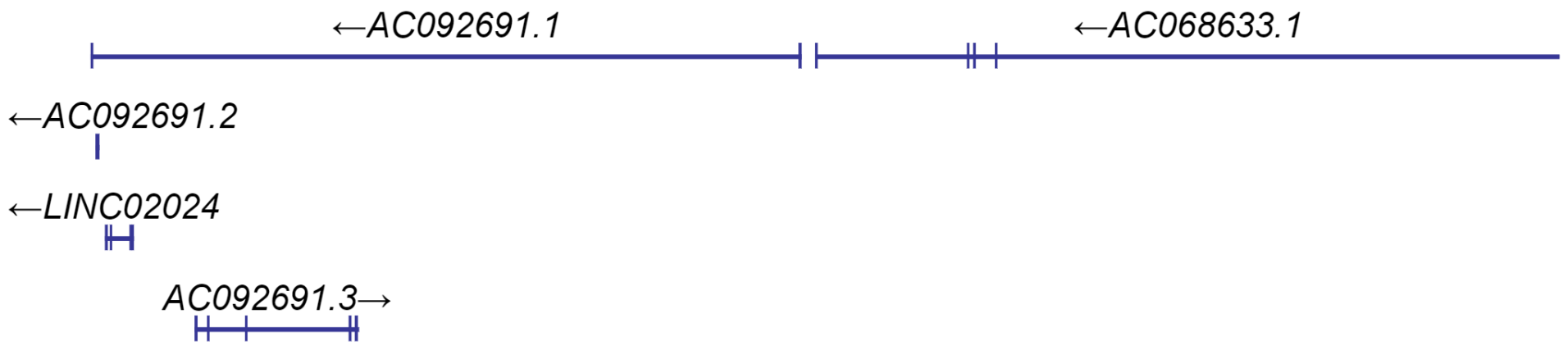
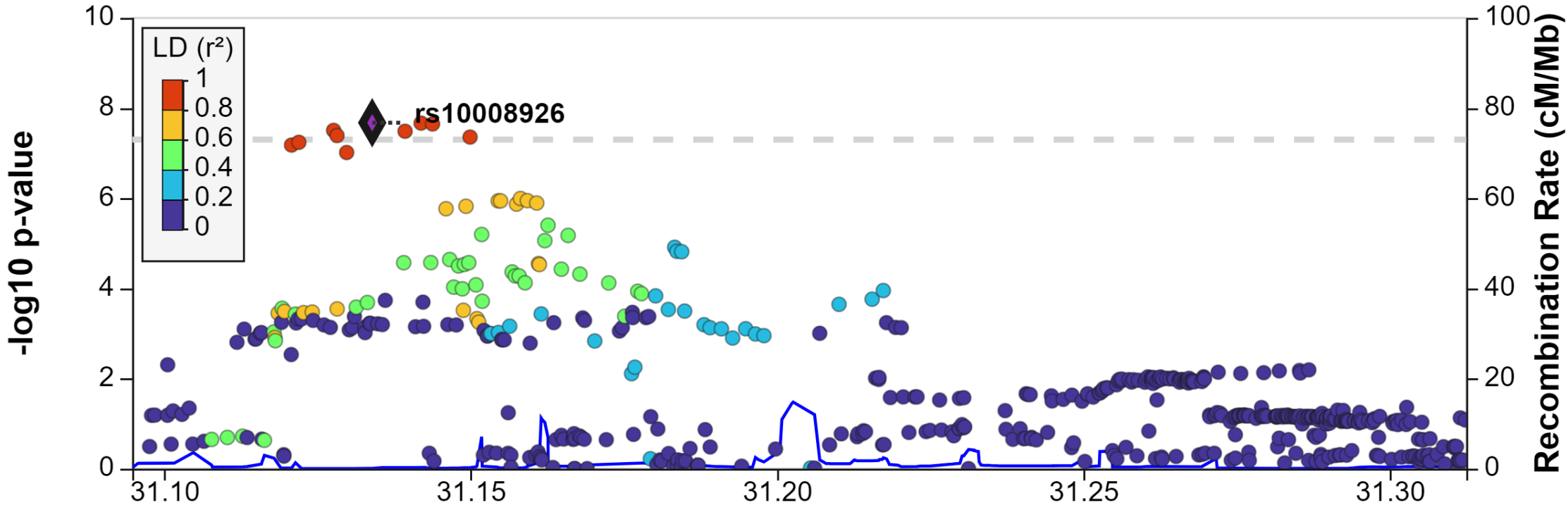

ADHDxCU GWAS

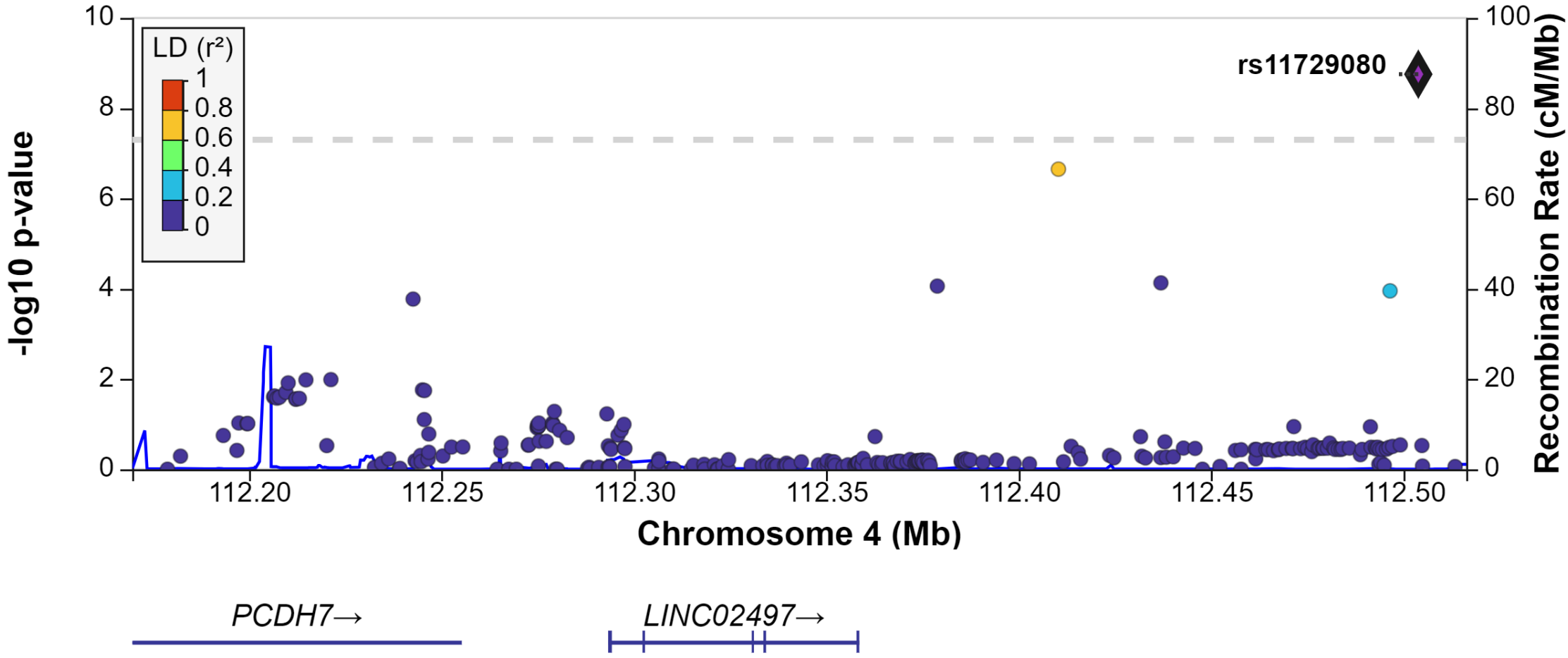

ADHDxCU GWAS

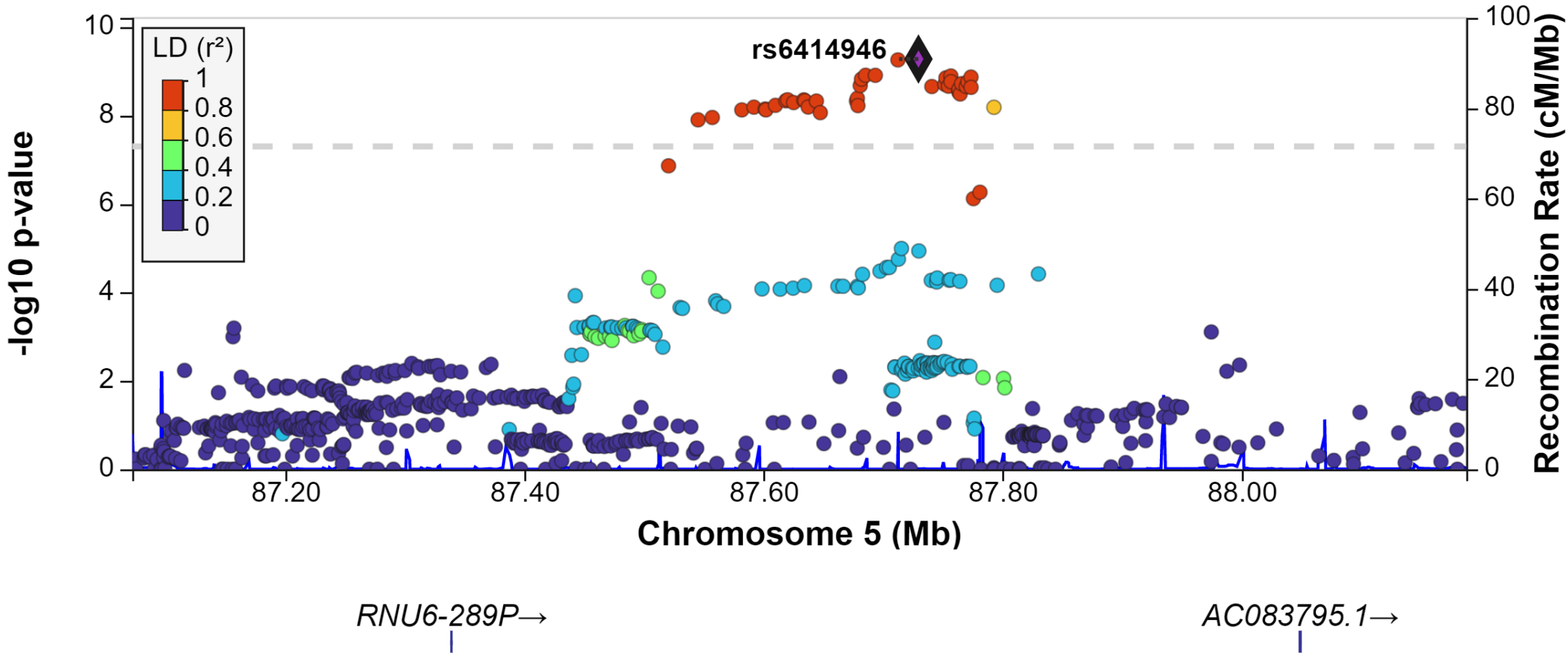

ADHDxCU GWAS

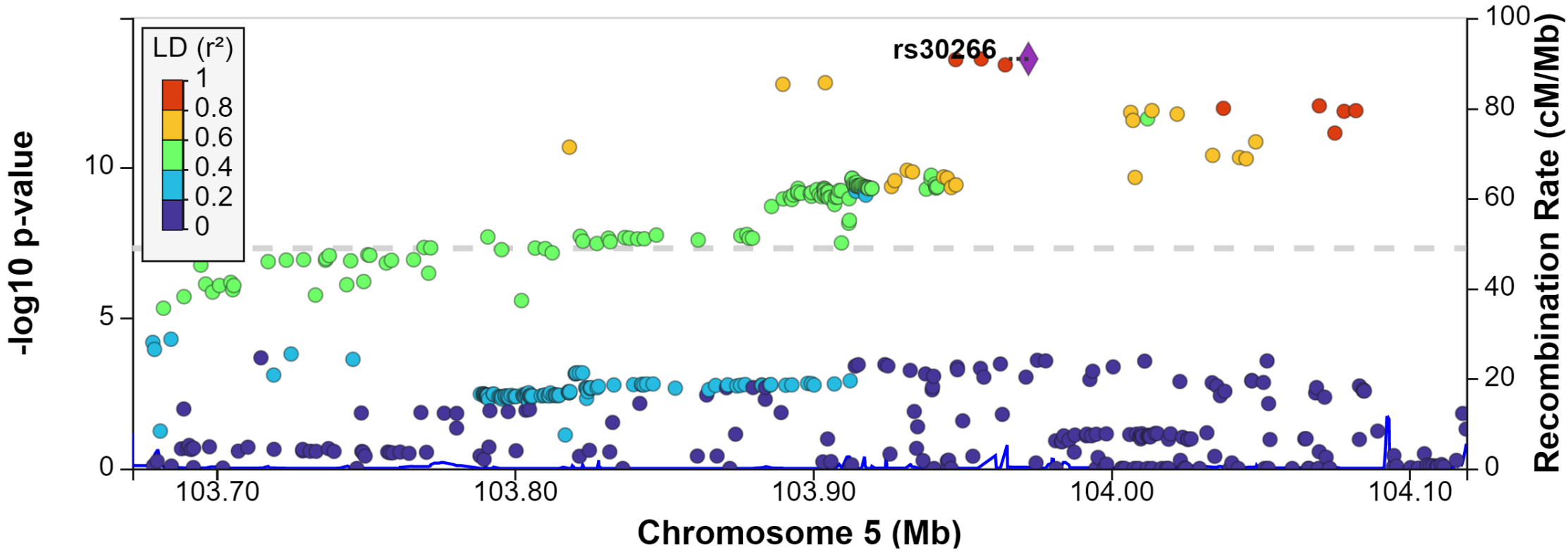

LINC02163→

AC099520.2→

←*AC099520.1*

AC091931.1→

←*RNU6-334P*

ADHDxCU GWAS

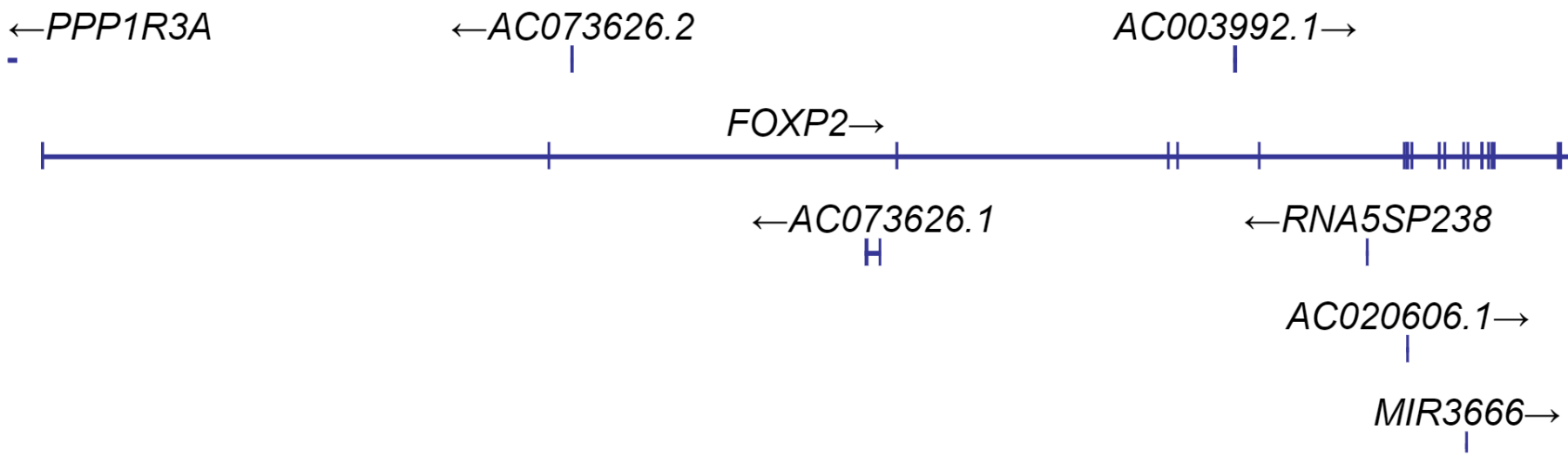
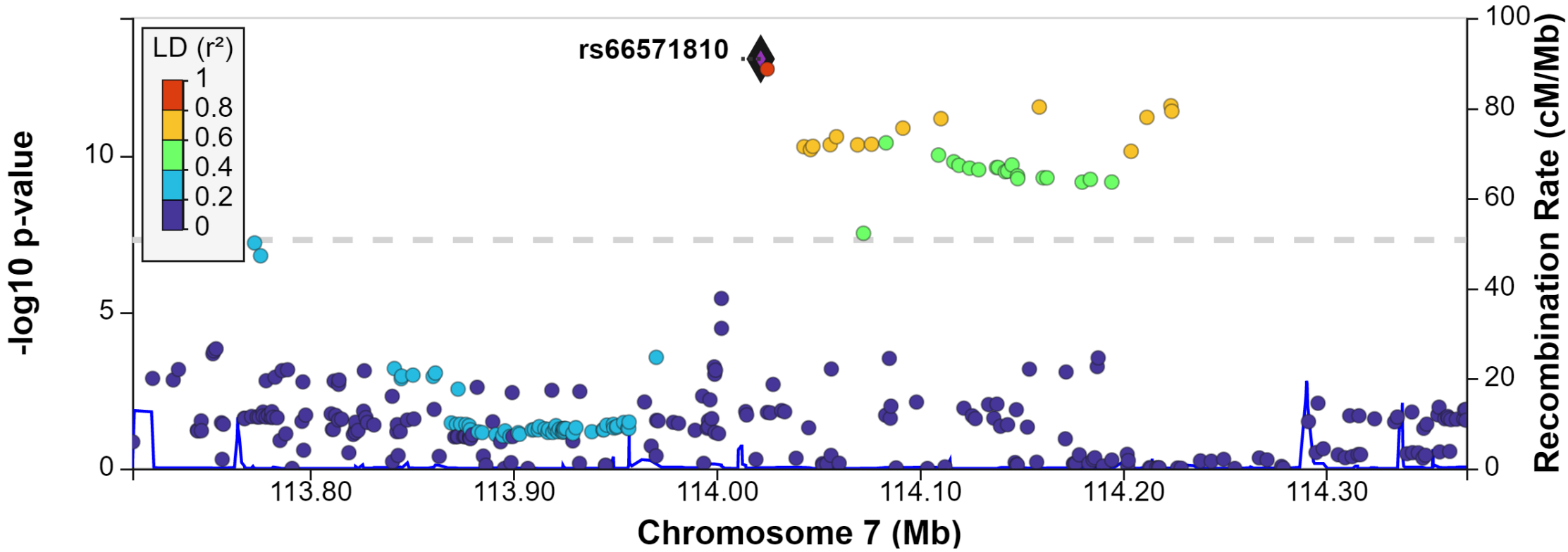

ADHDxCU GWAS

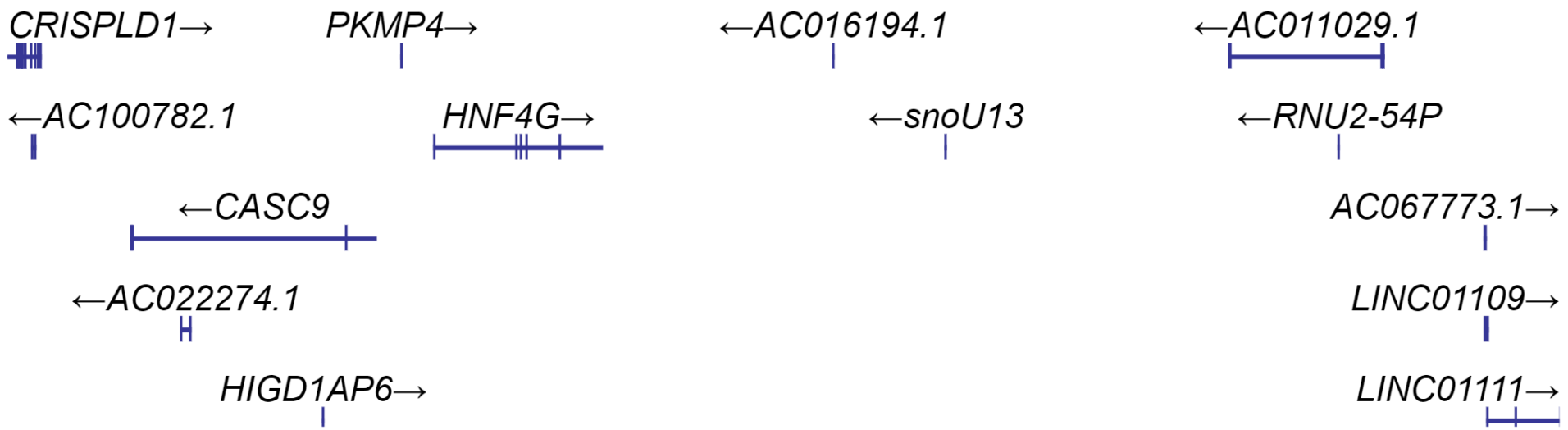
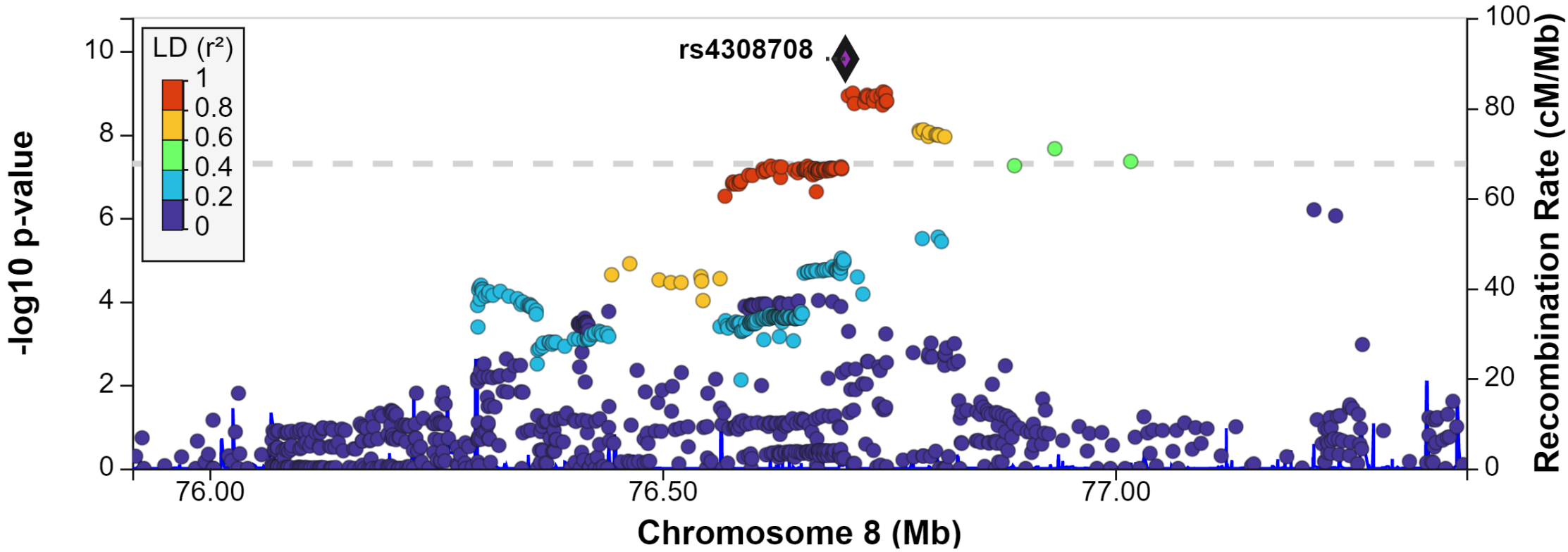

ADHDxCU GWAS

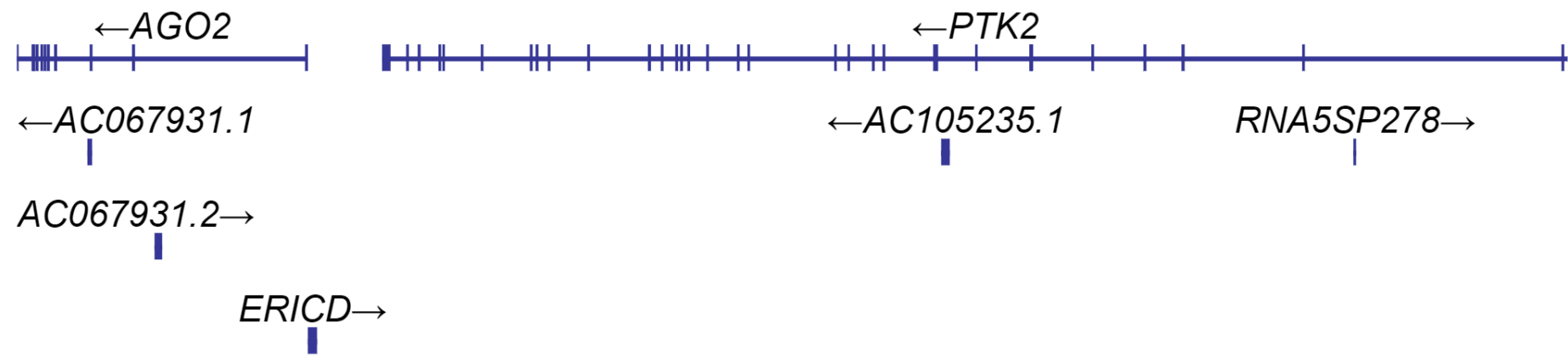
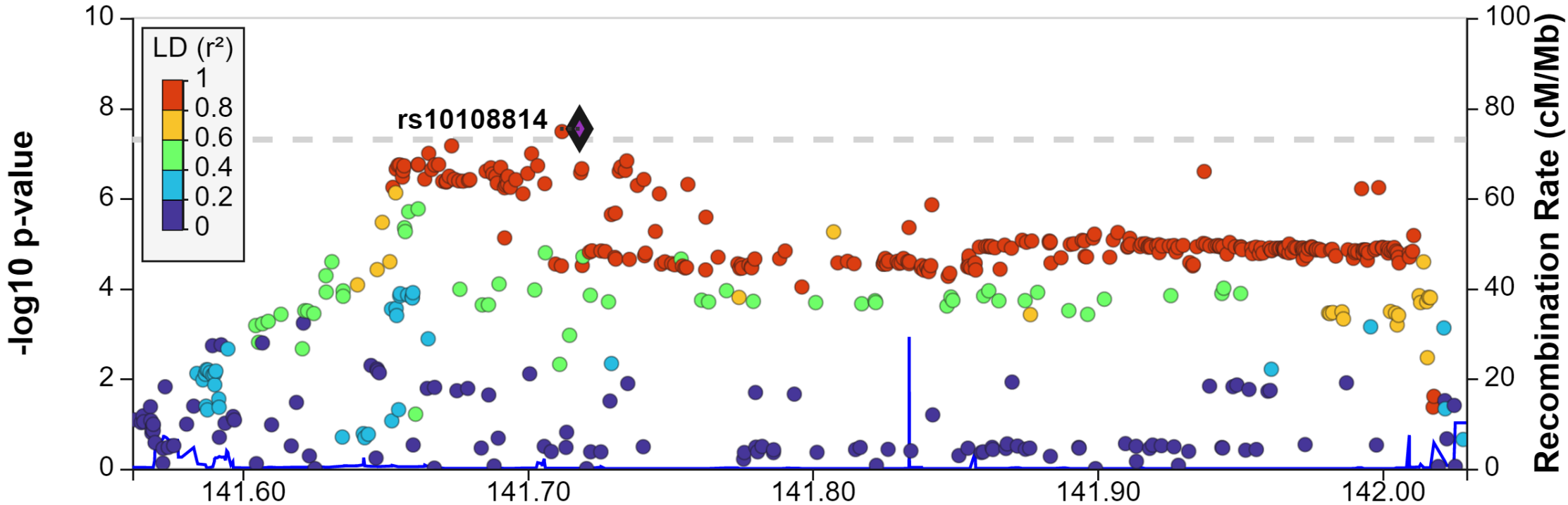

ADHDxCU GWAS

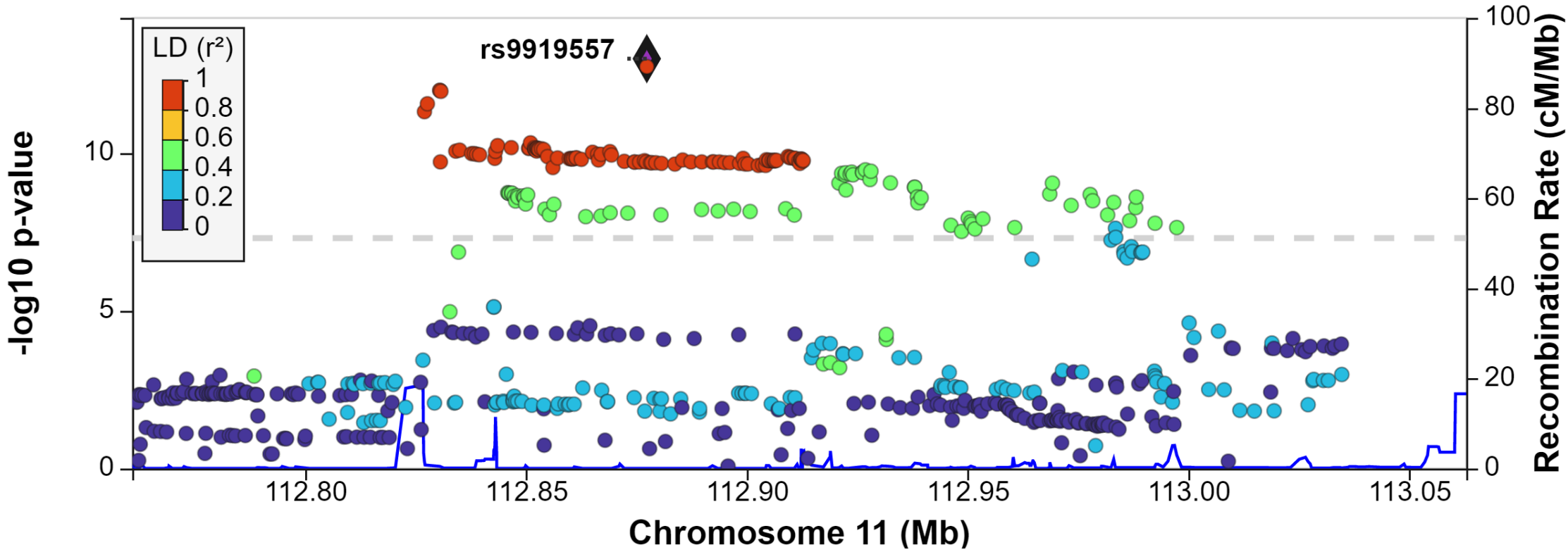

← *AP000802.1*



NCAM1 →

RNU7-187P →

ADHDxCU GWAS

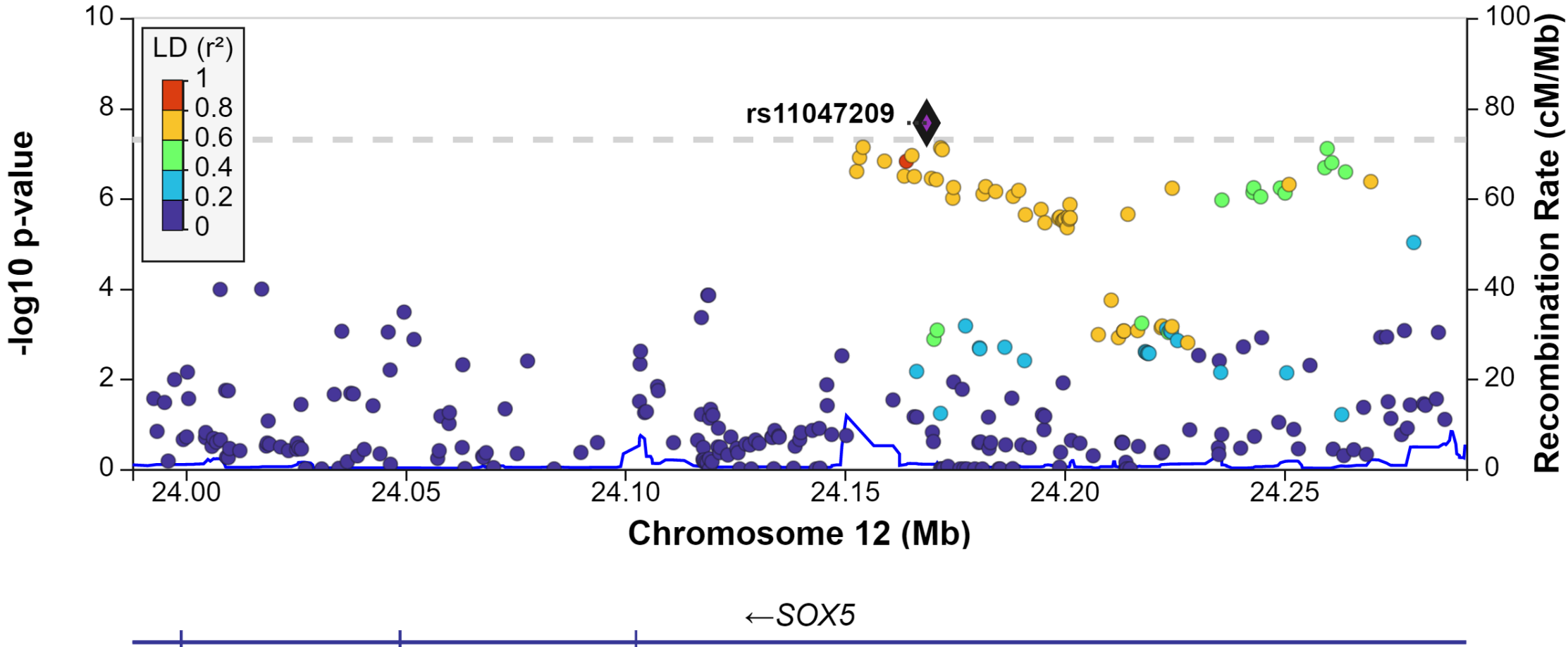

ADHDxCU GWAS

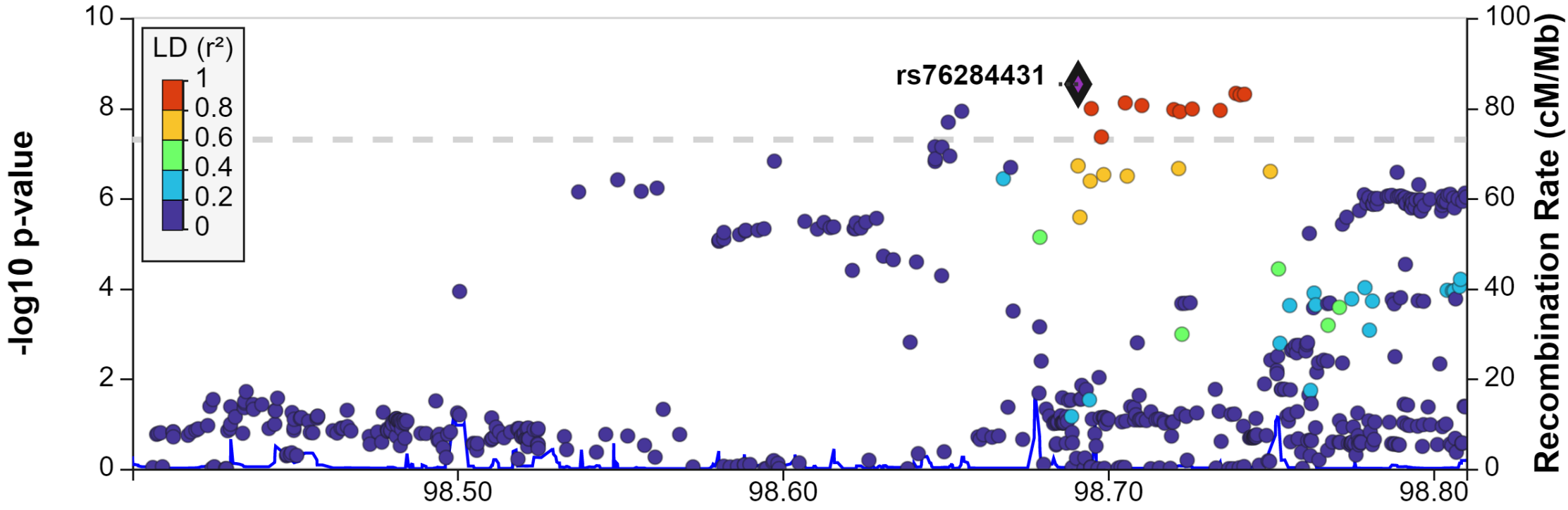

← *LINC01550*

← *AL163932.1*

← *AL163760.1*

LINC02295 →
H

ADHDxCUD GWAS

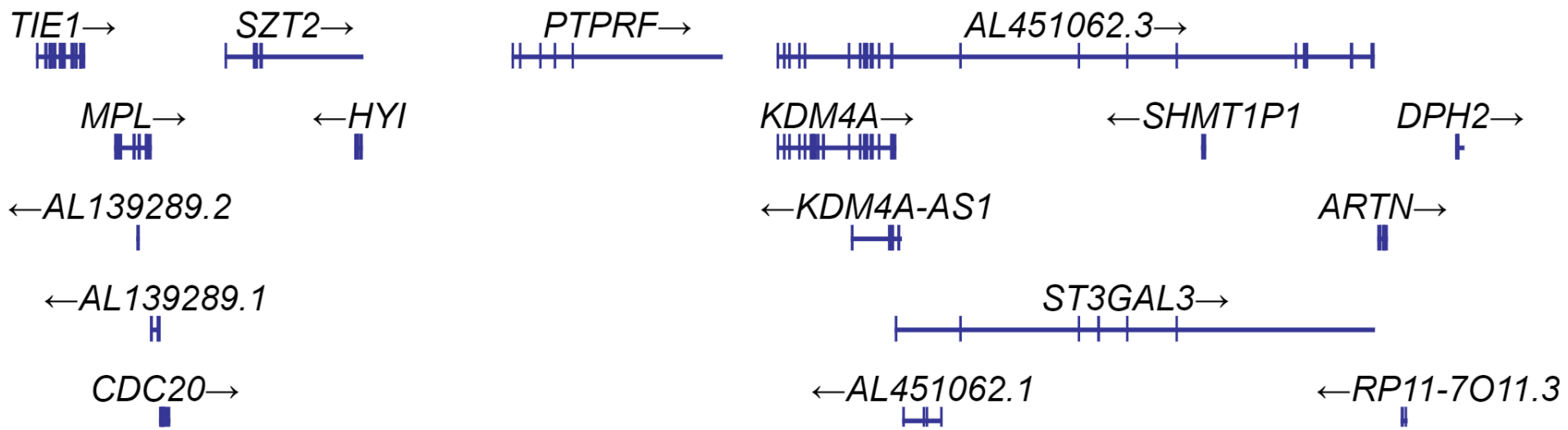
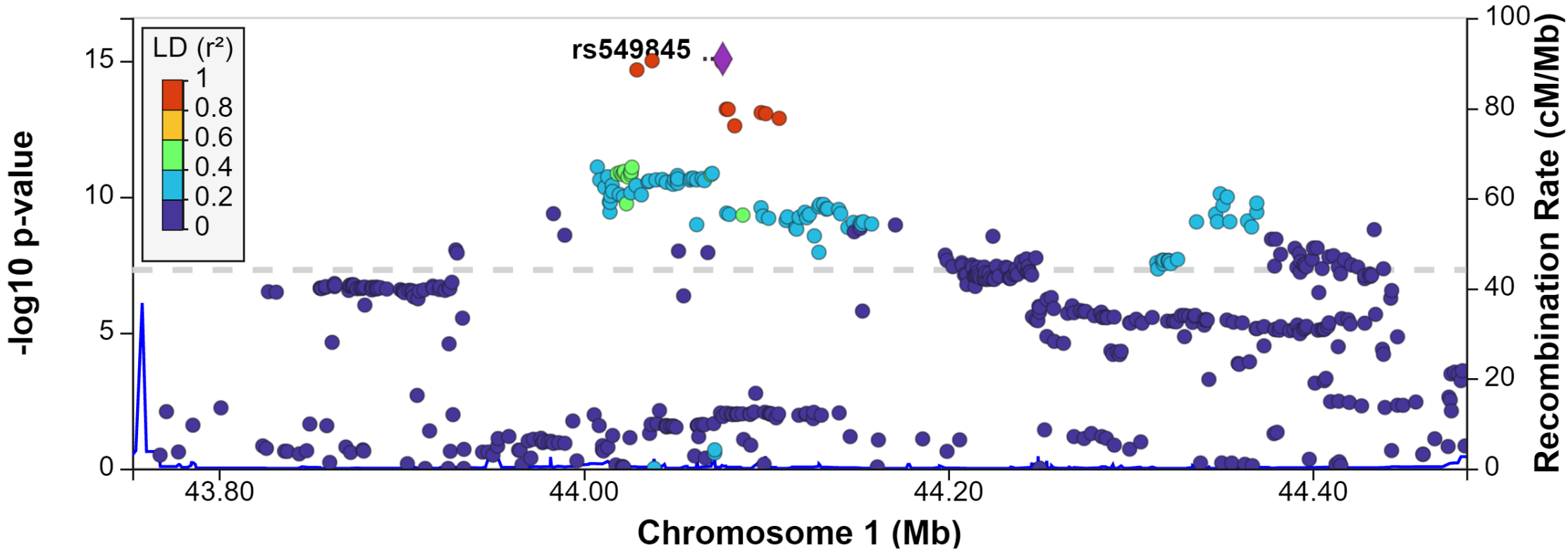

ADHDxCD GWAS

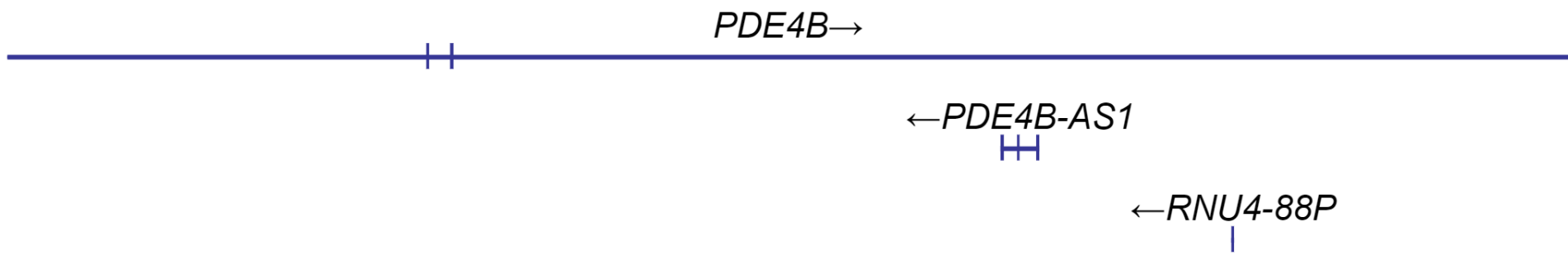
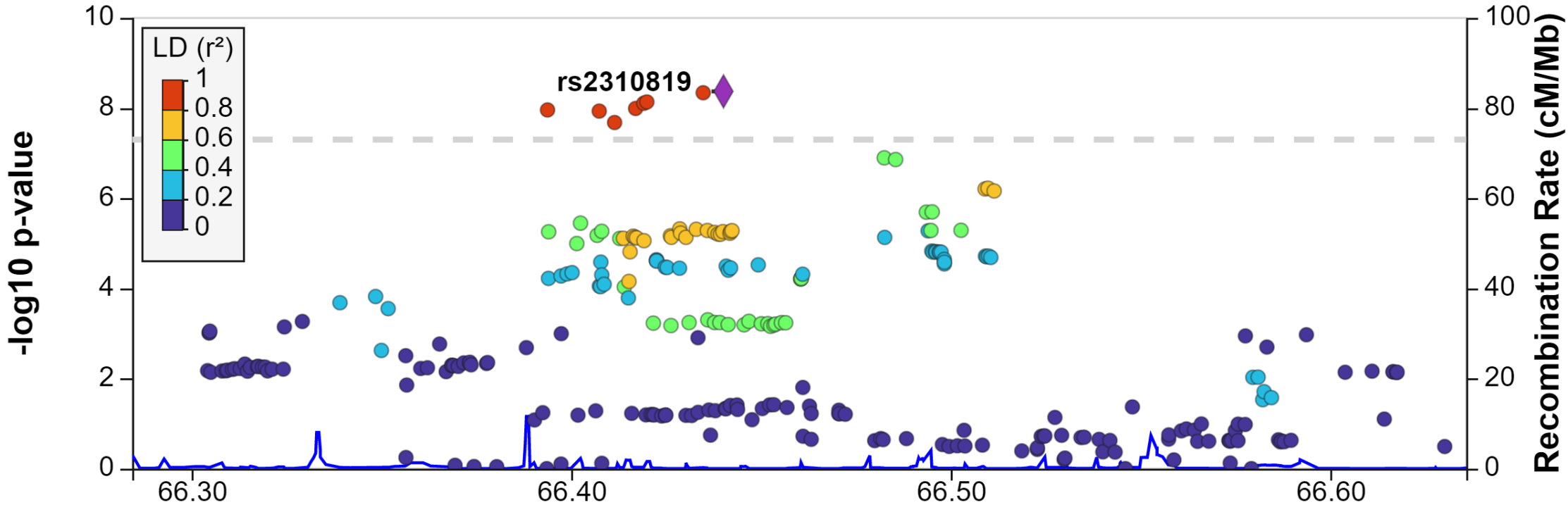

ADHDxCUD GWAS

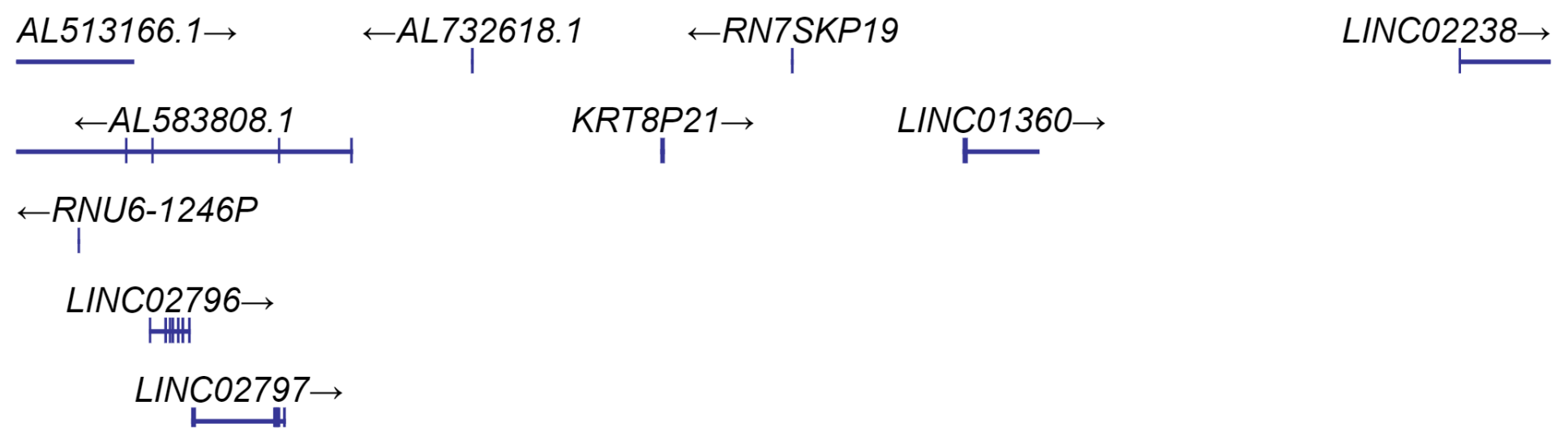
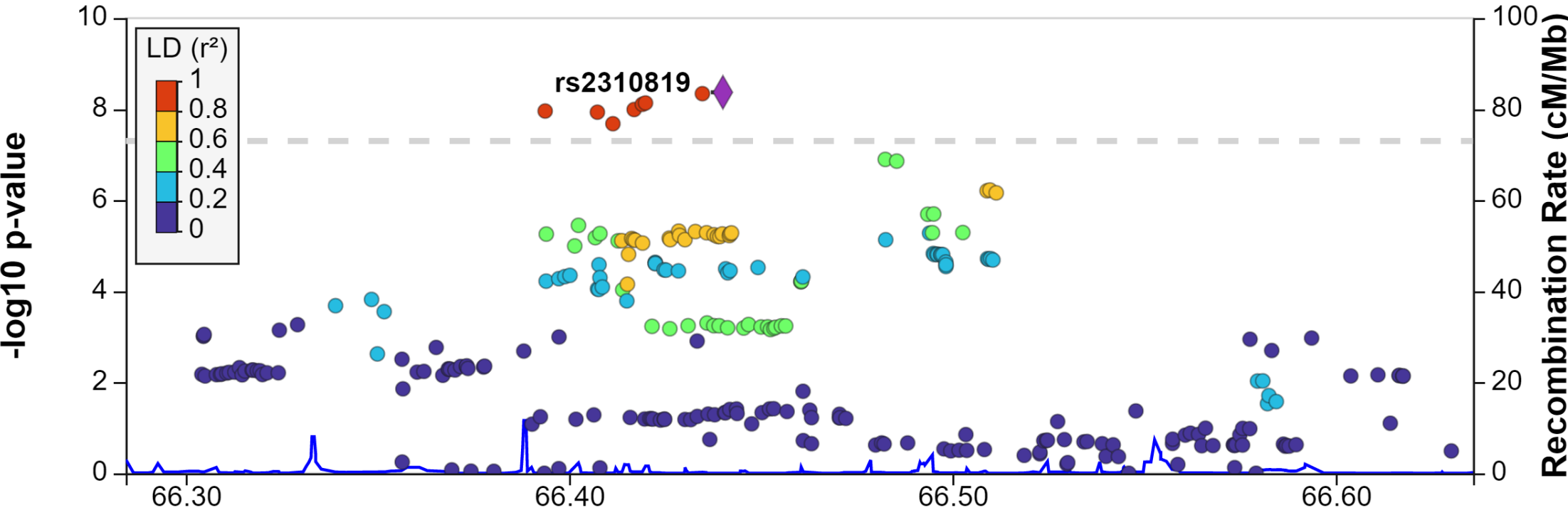

ADHDxCUD GWAS

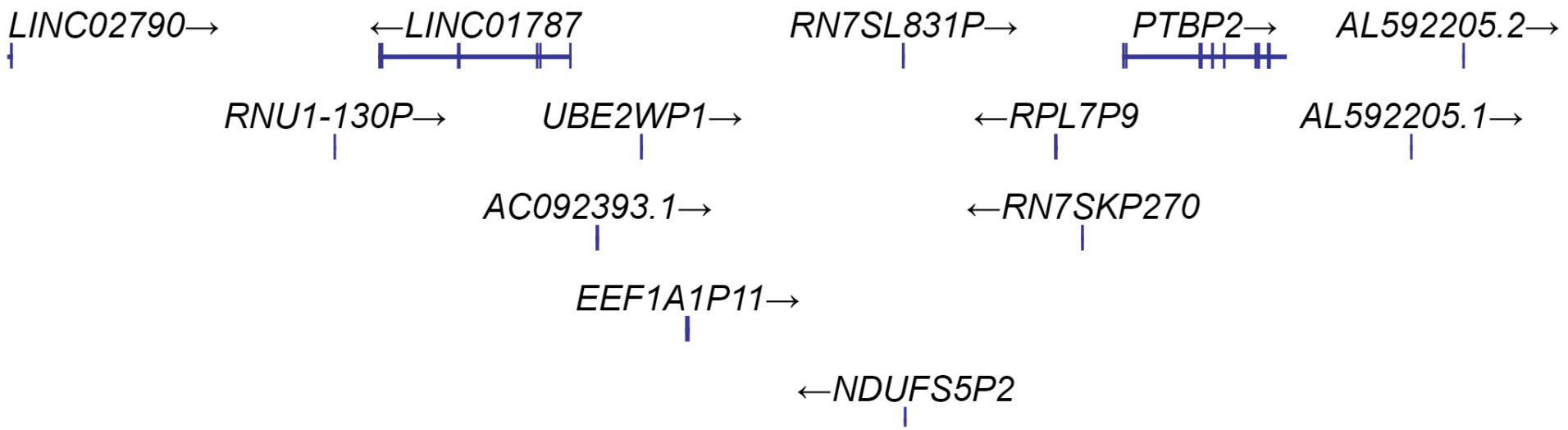
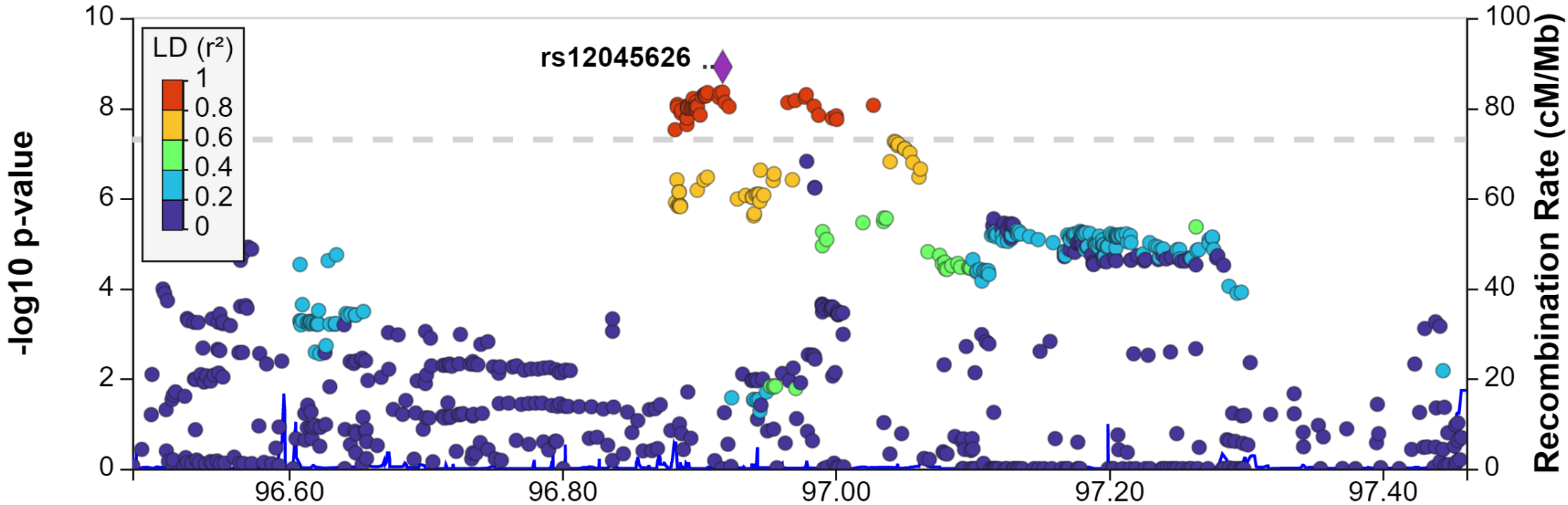

ADHDxCUD GWAS

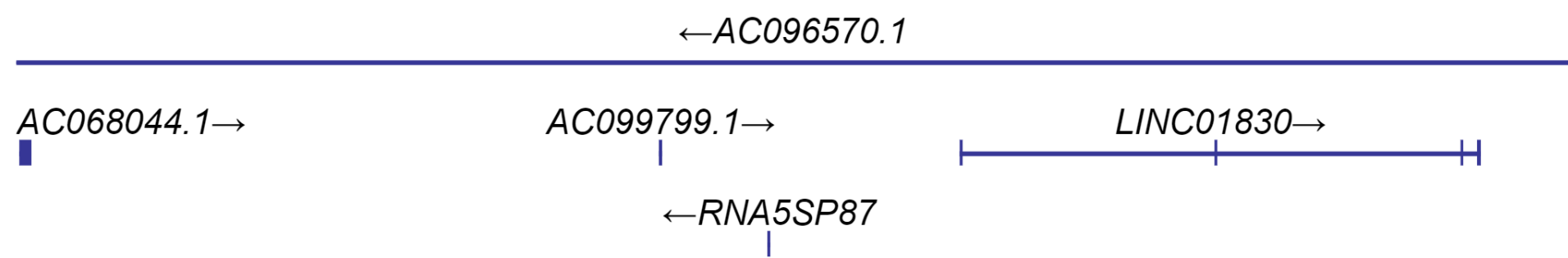
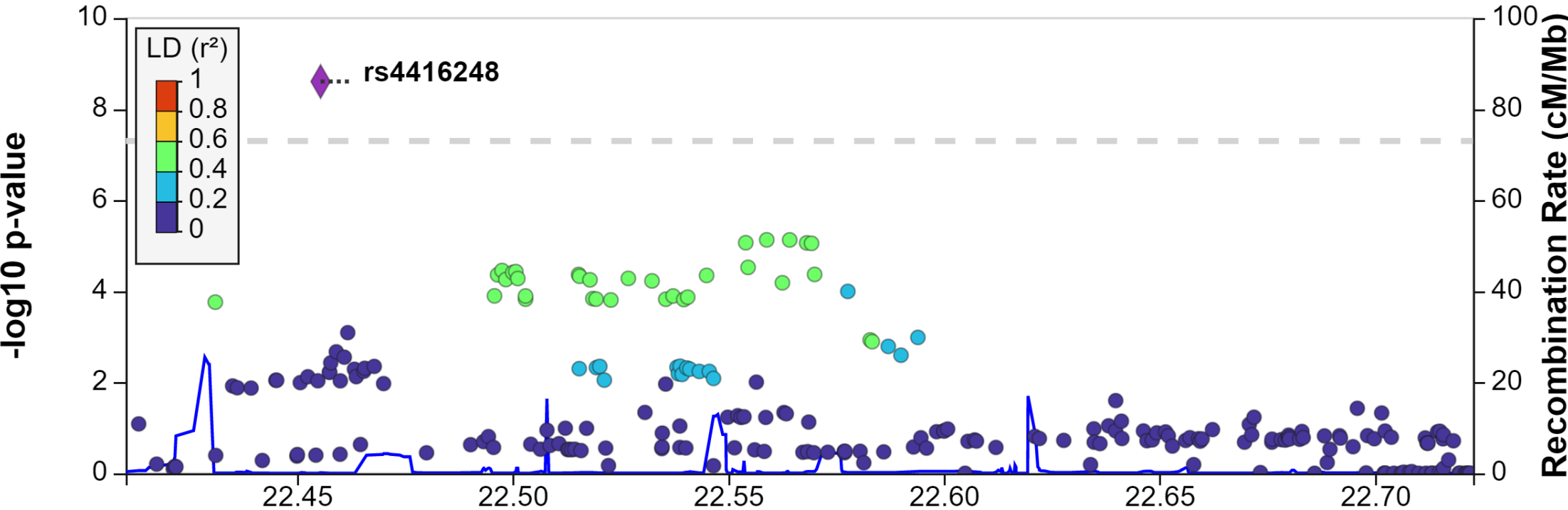

ADHDxCUD GWAS

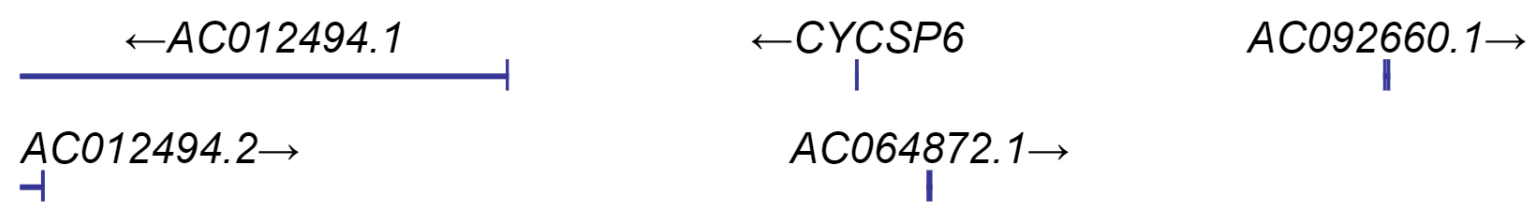
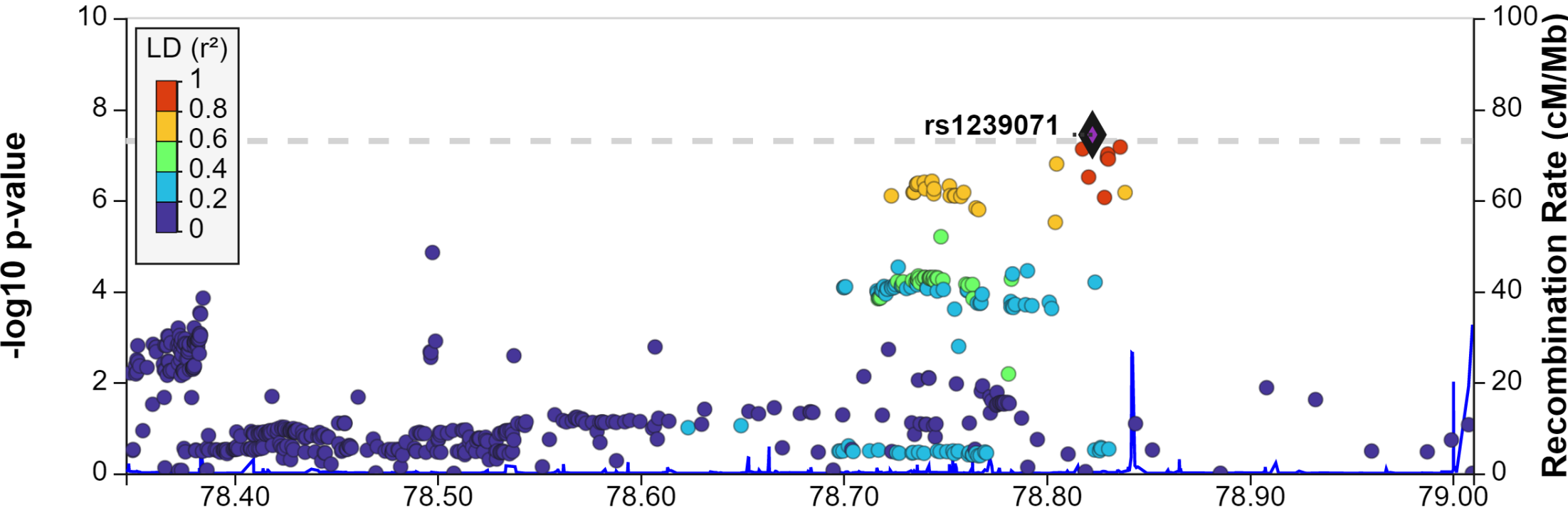

ADHDxCUD GWAS

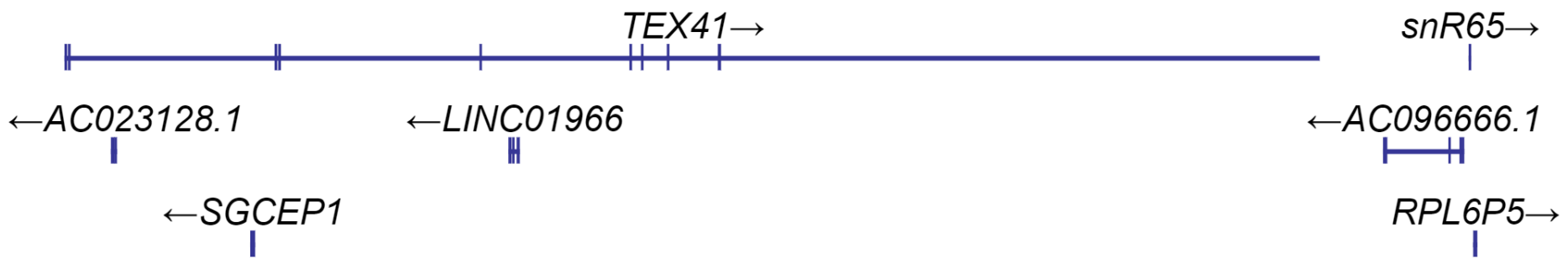
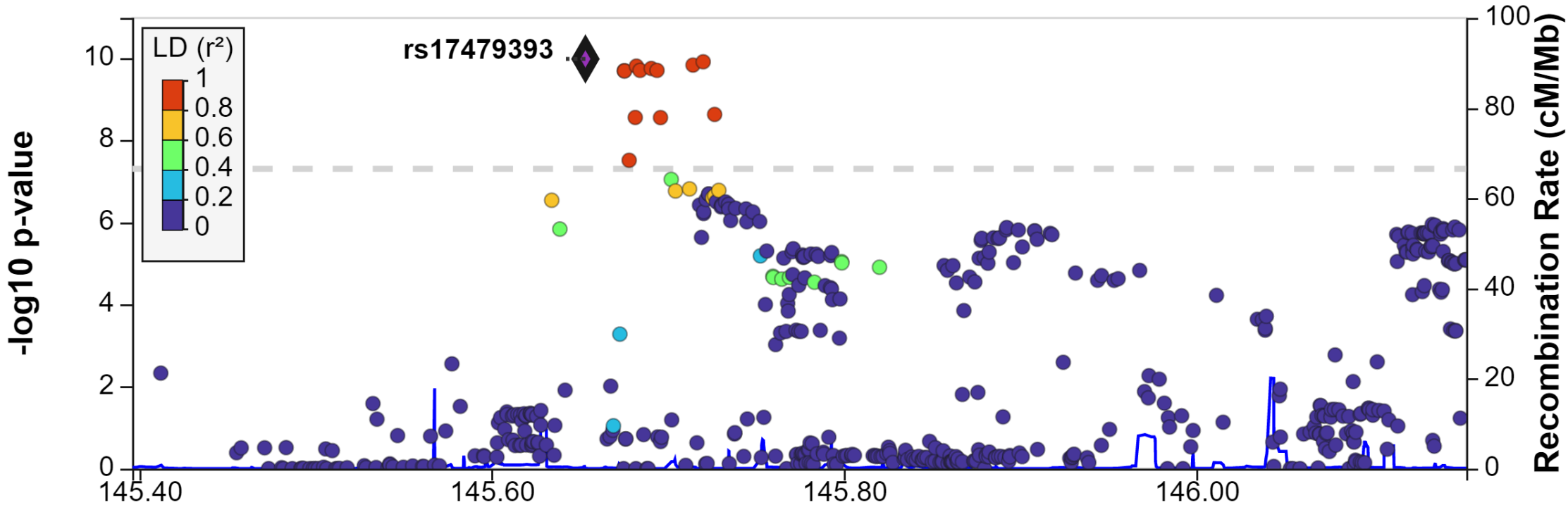

ADHDxCUD GWAS

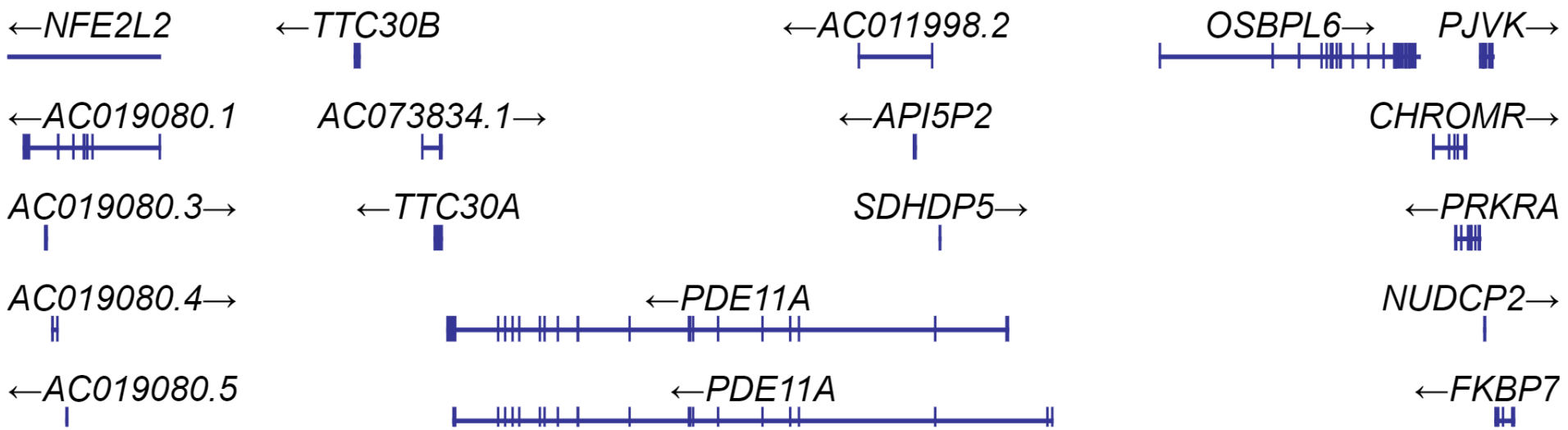
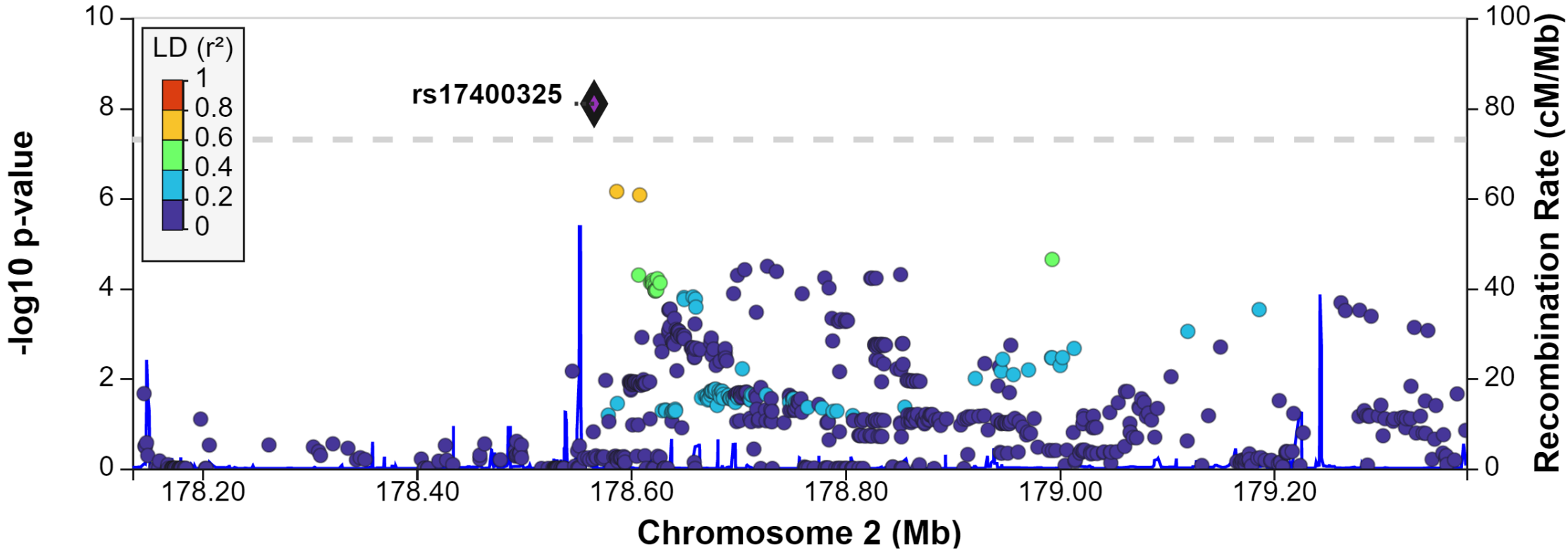

ADHDxCUD GWAS

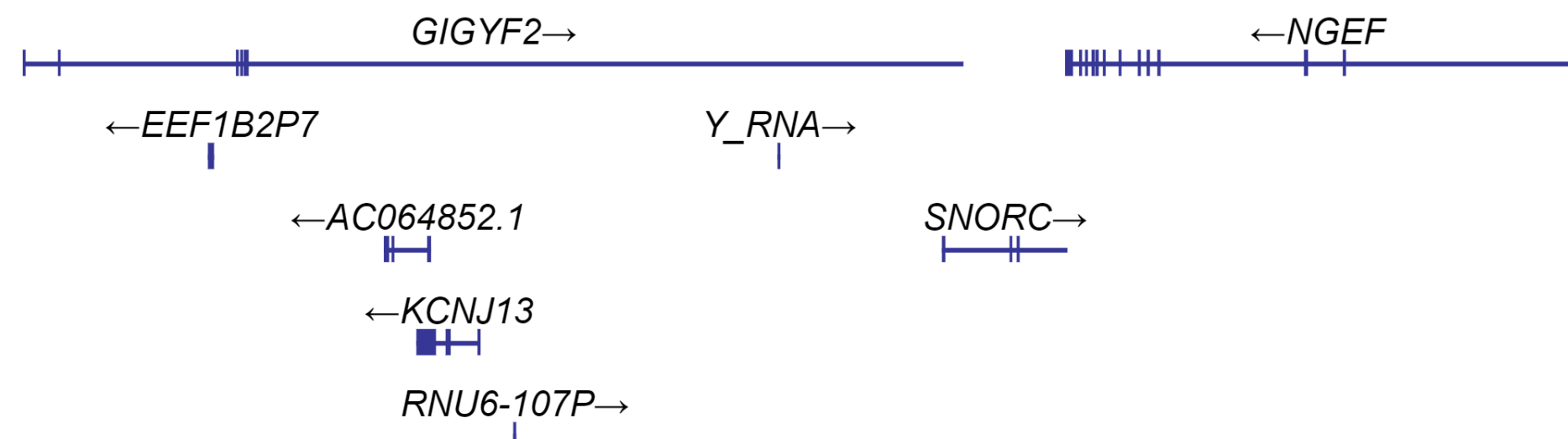
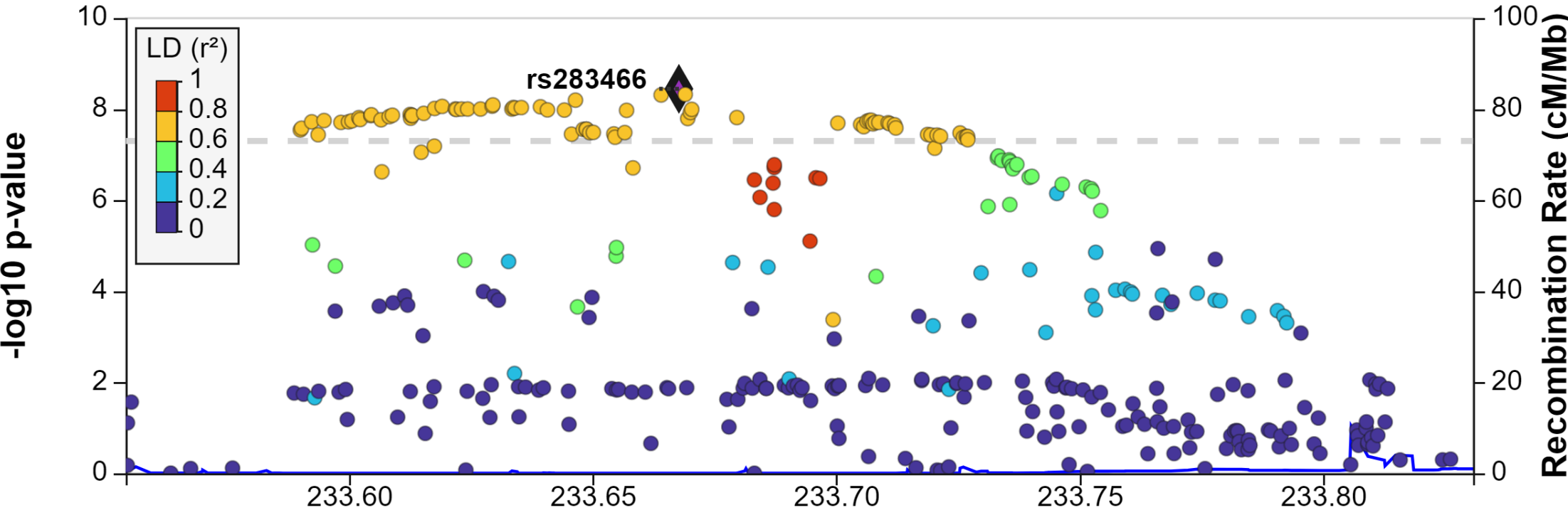

ADHDxCUD GWAS

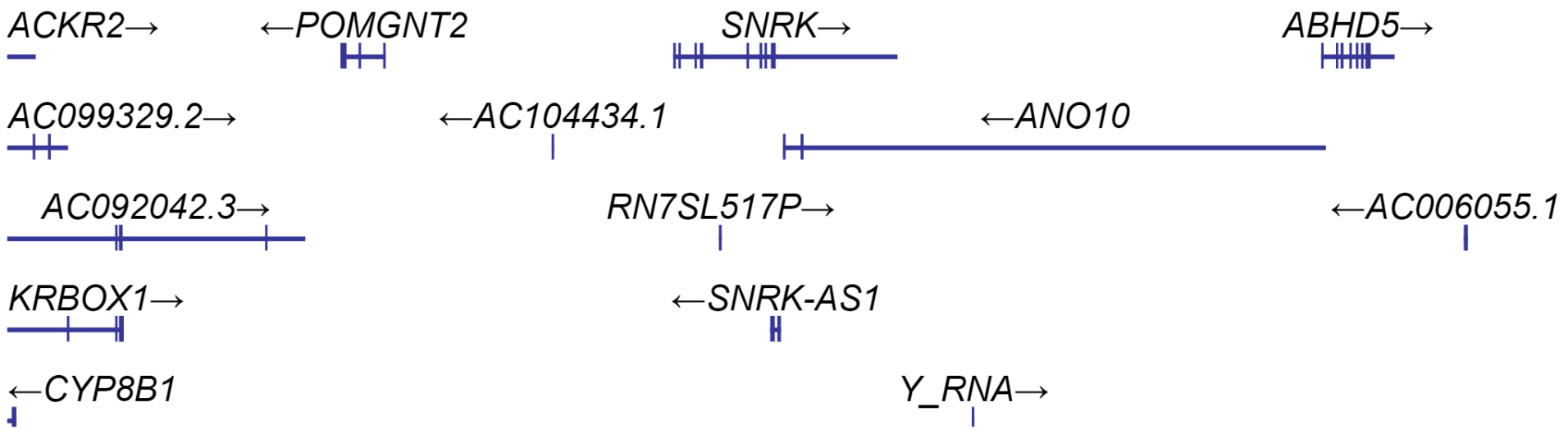
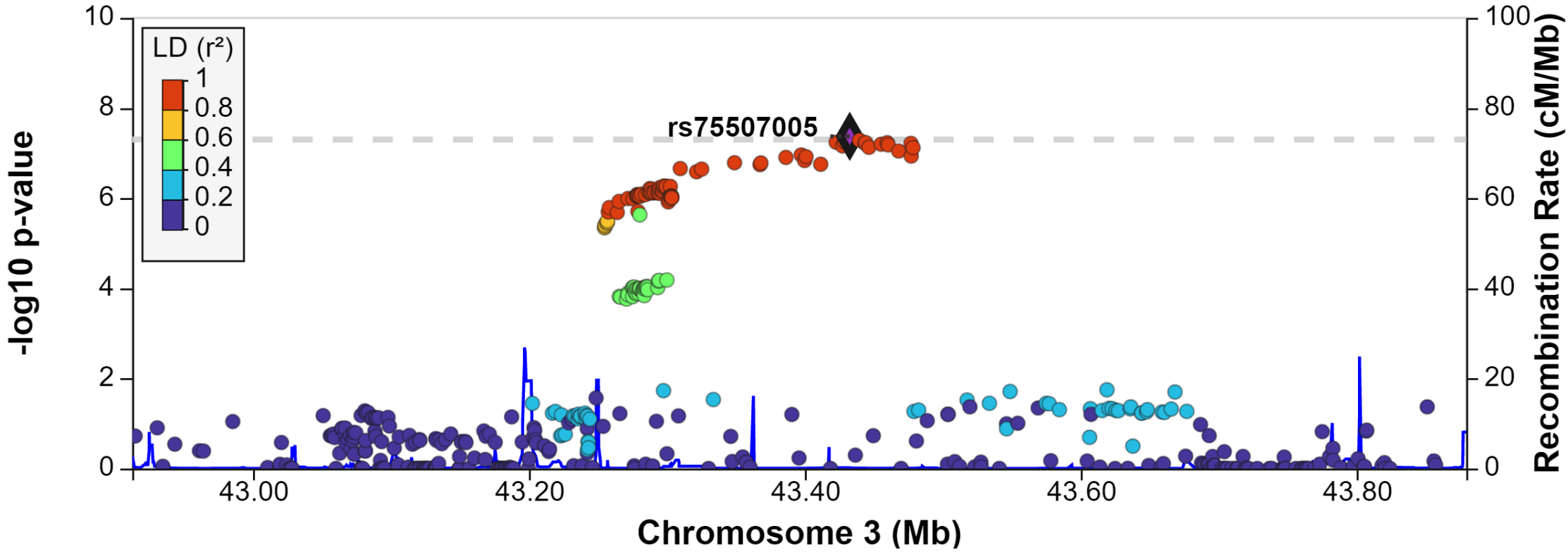

ADHDxCUD GWAS

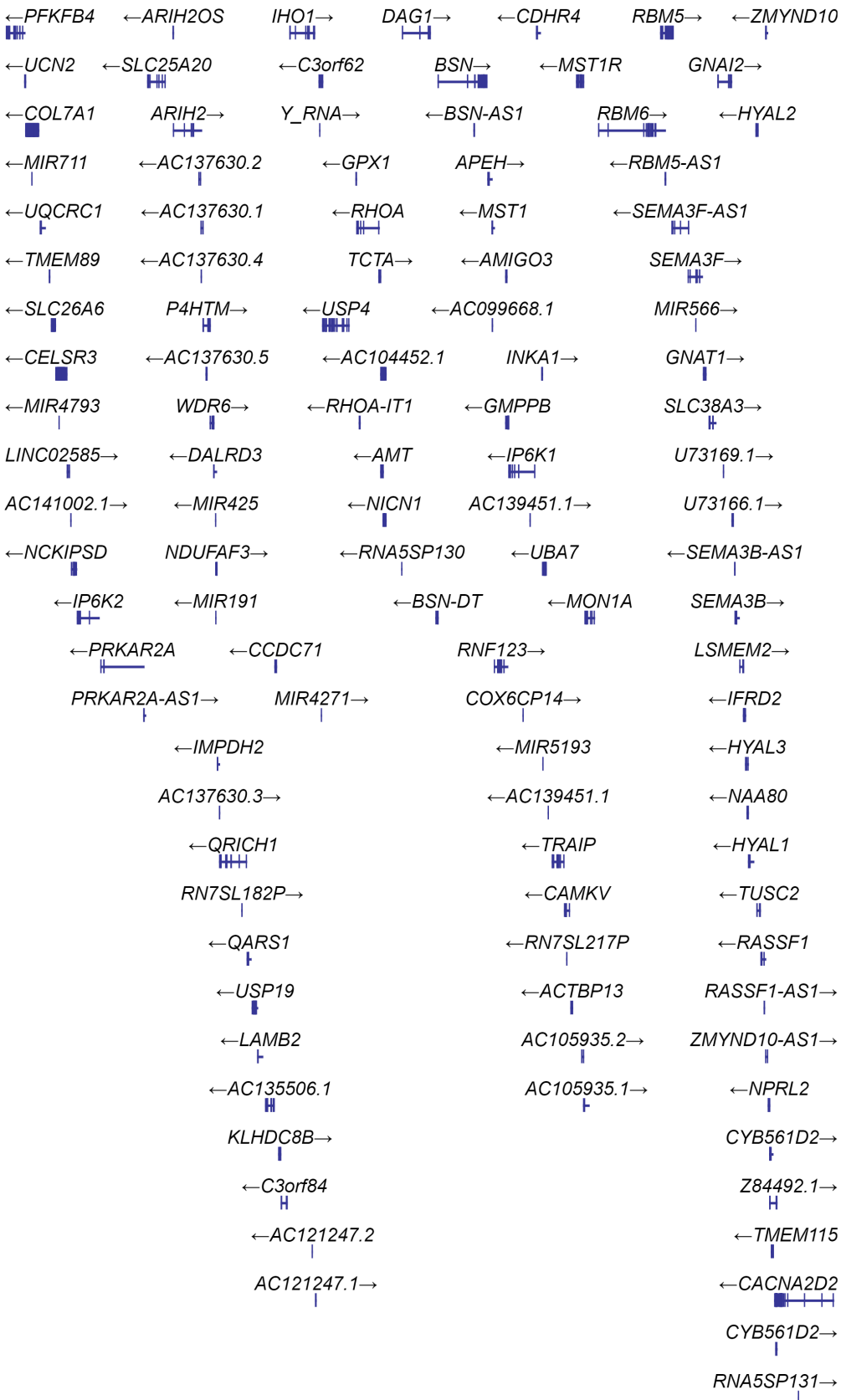
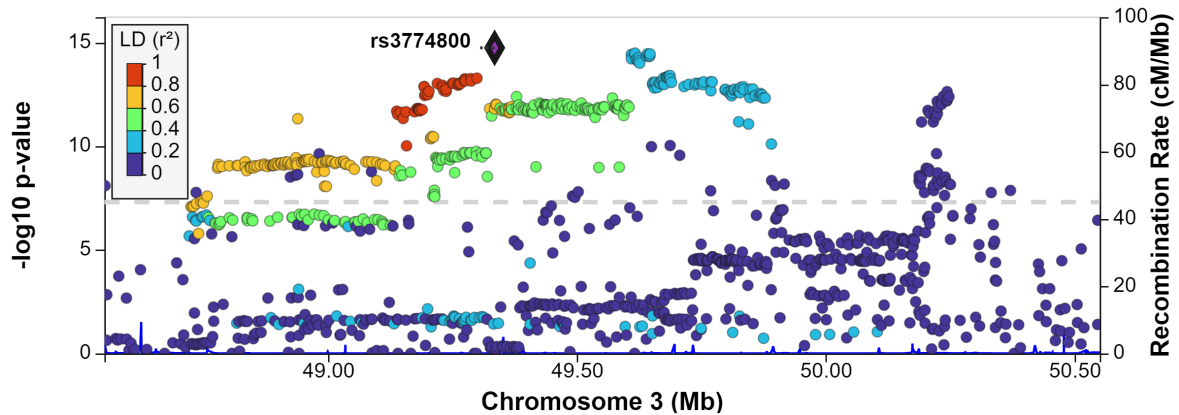

ADHDxCUD GWAS

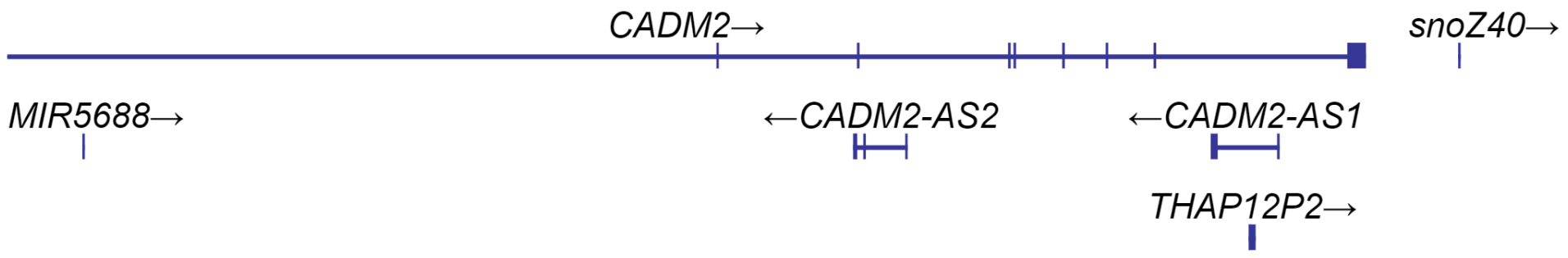
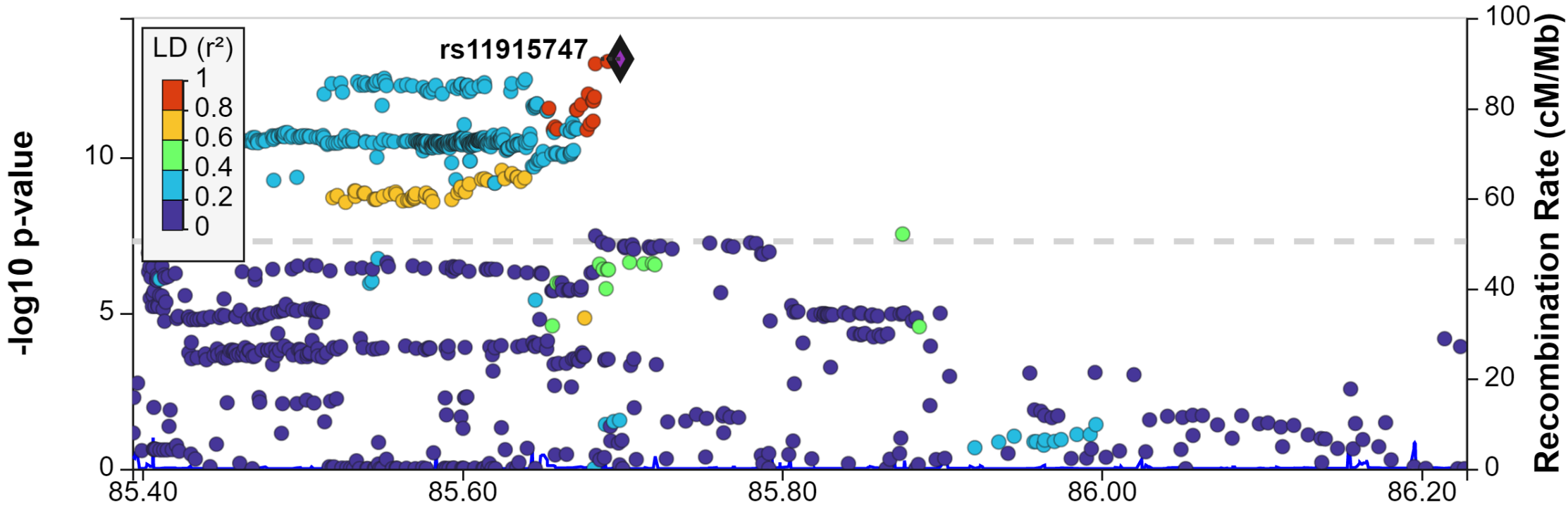

ADHDxCUD GWAS

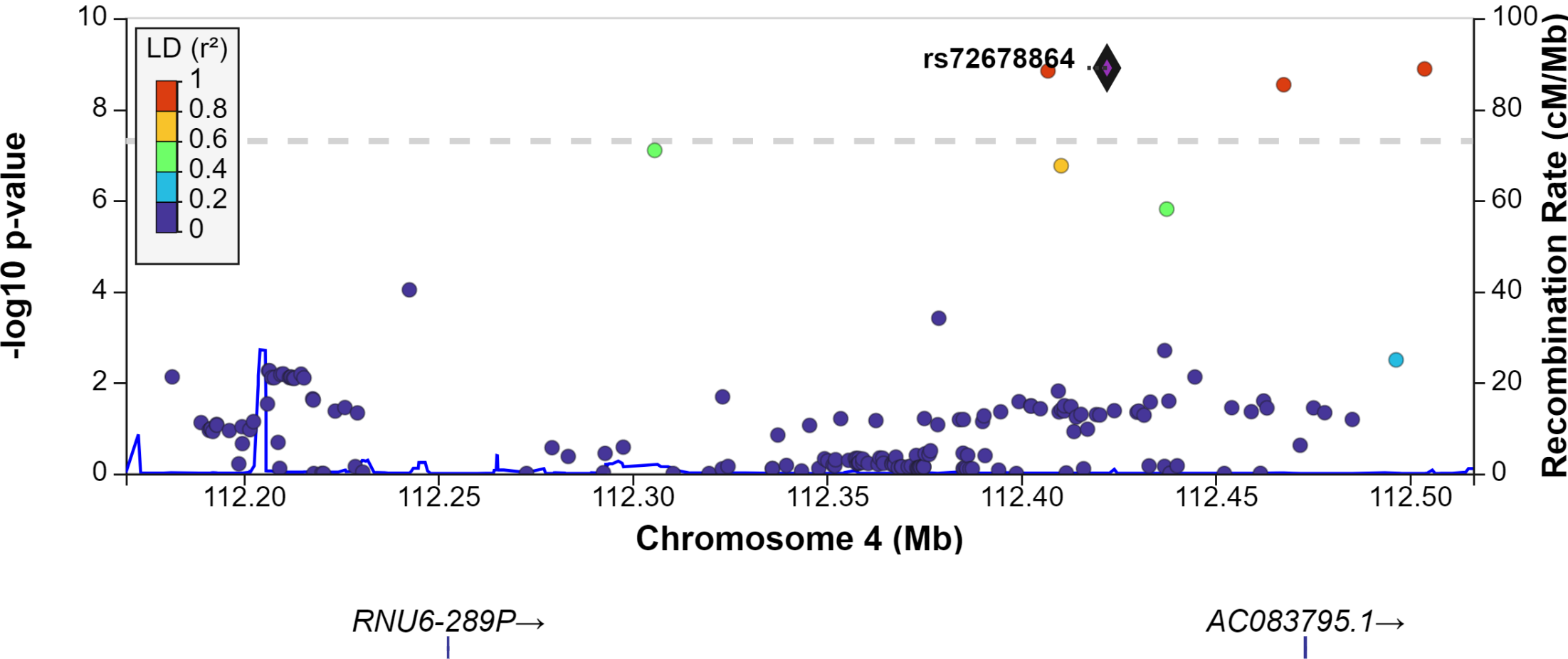

ADHDxCUD GWAS

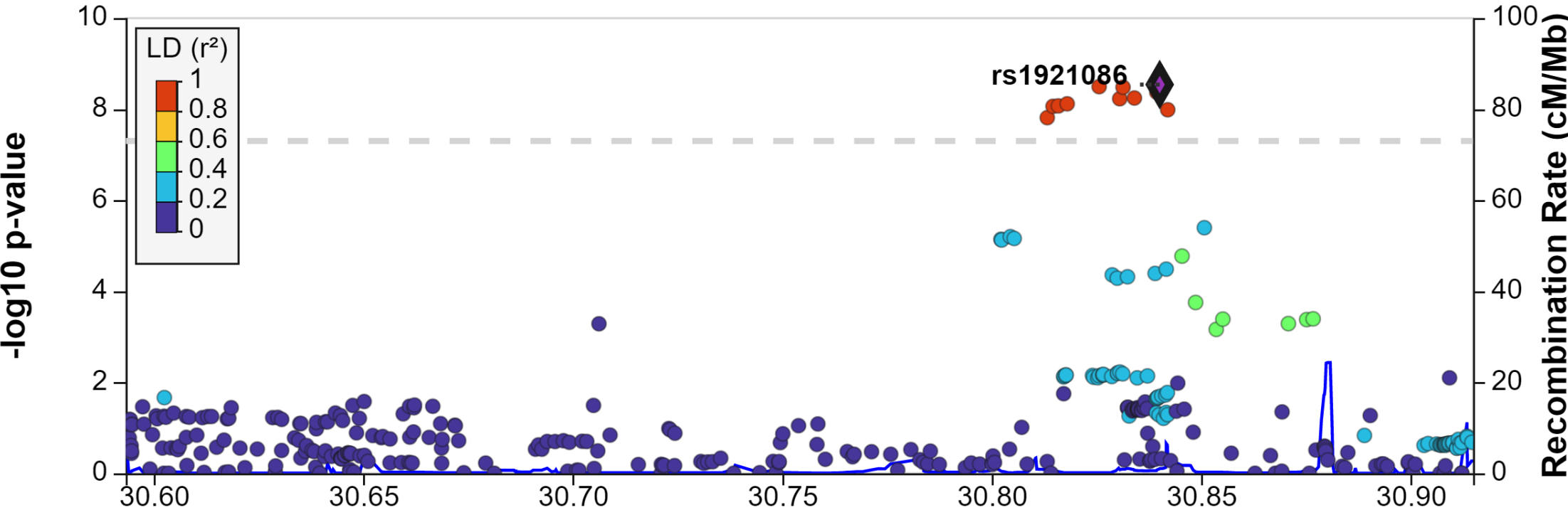

←AC099517.1

←AC026433.1

ADHDxCUD GWAS

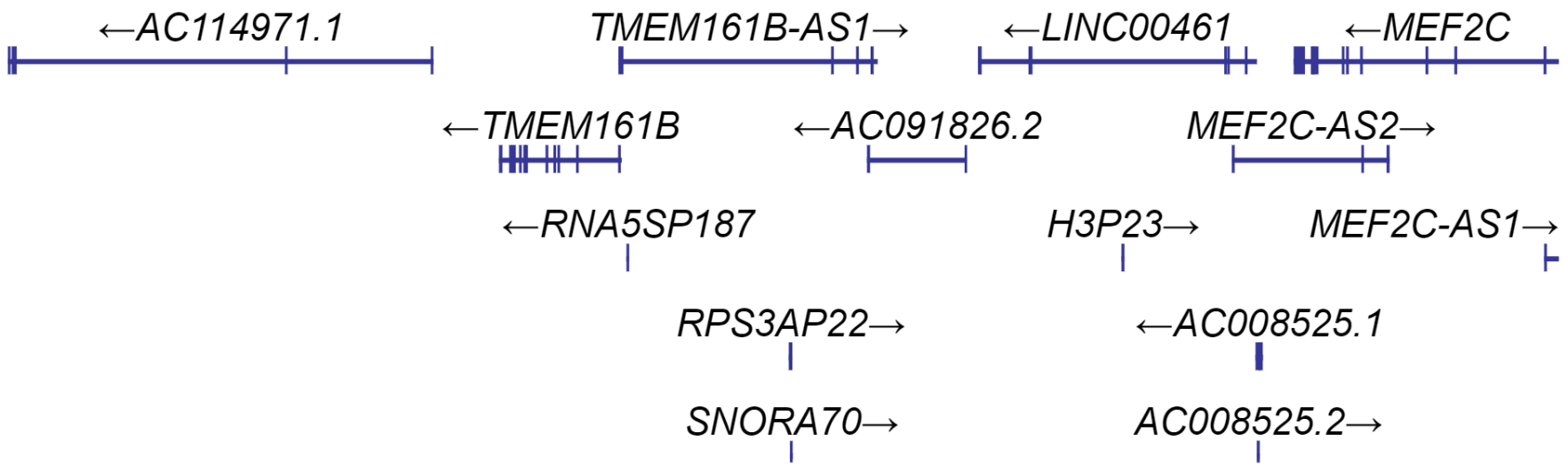
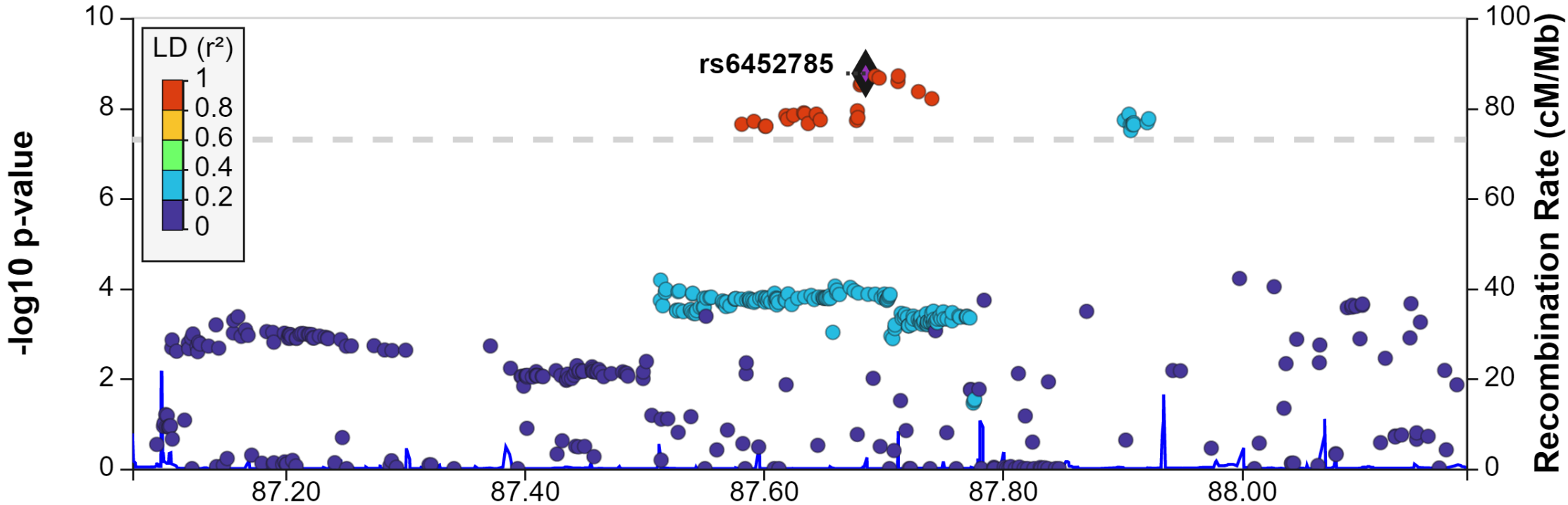

ADHDxCUD GWAS

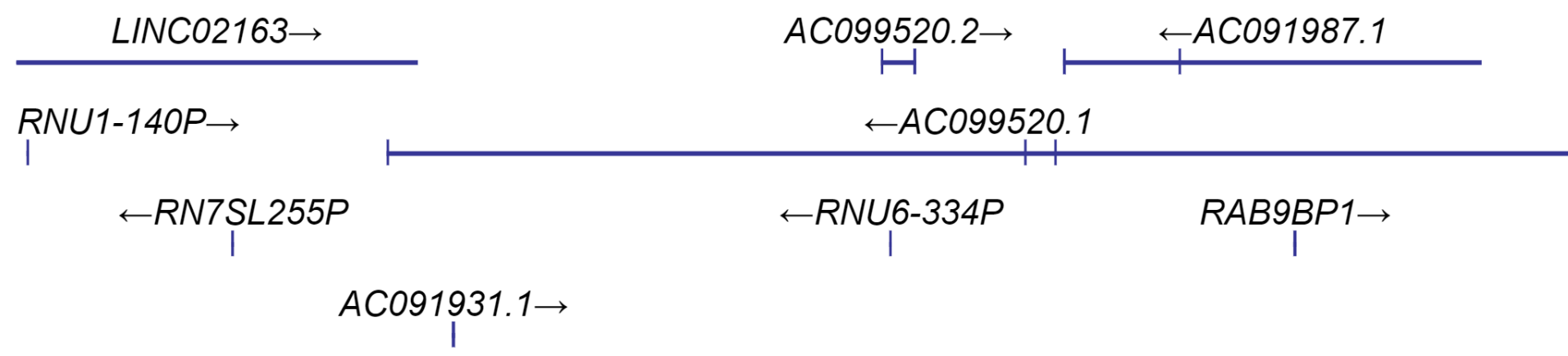
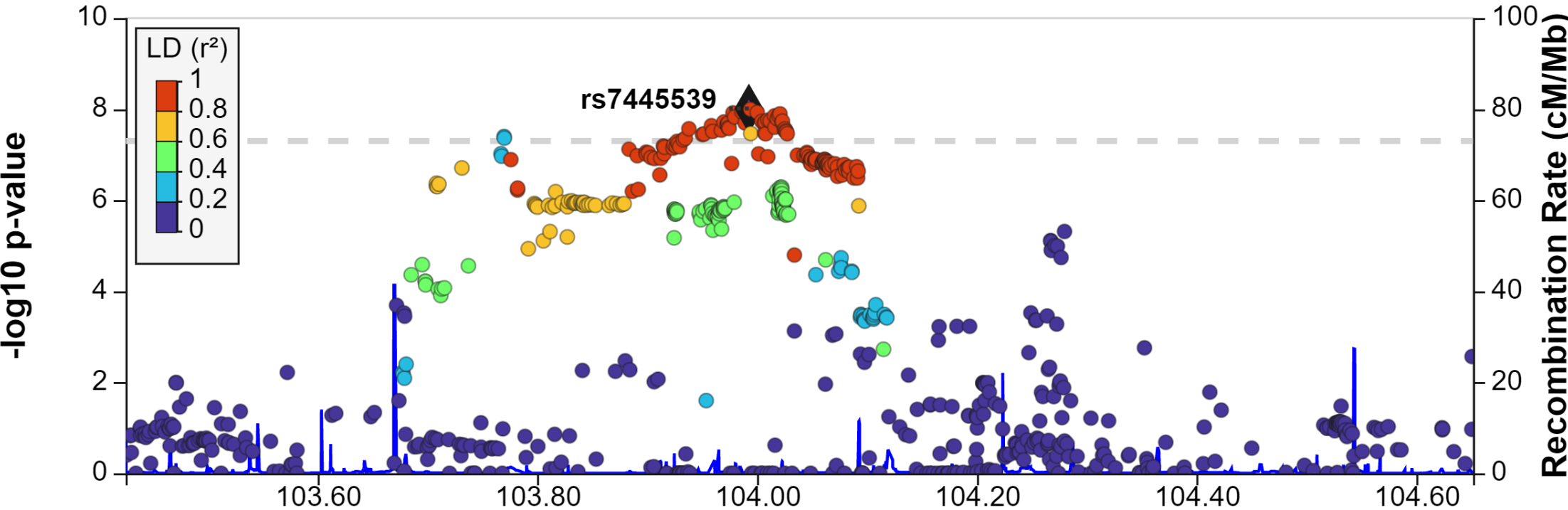

ADHDxCDU GWAS

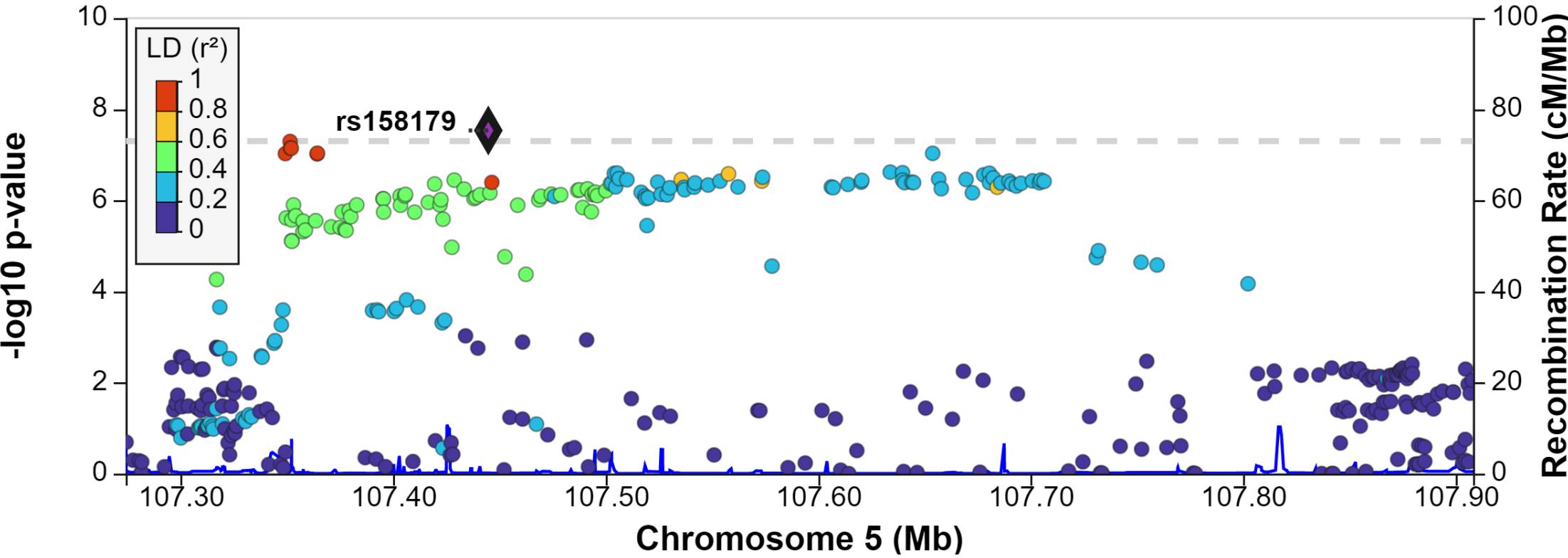

← *FBXL17*

AC008462.1 →

ADHDxCUD GWAS

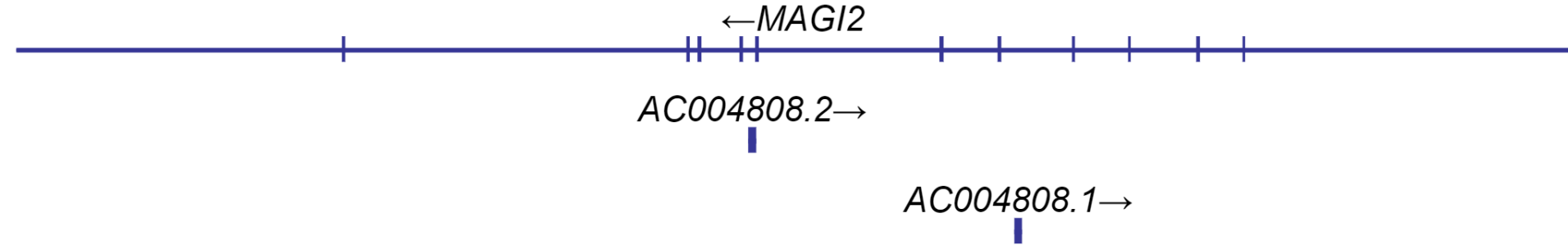
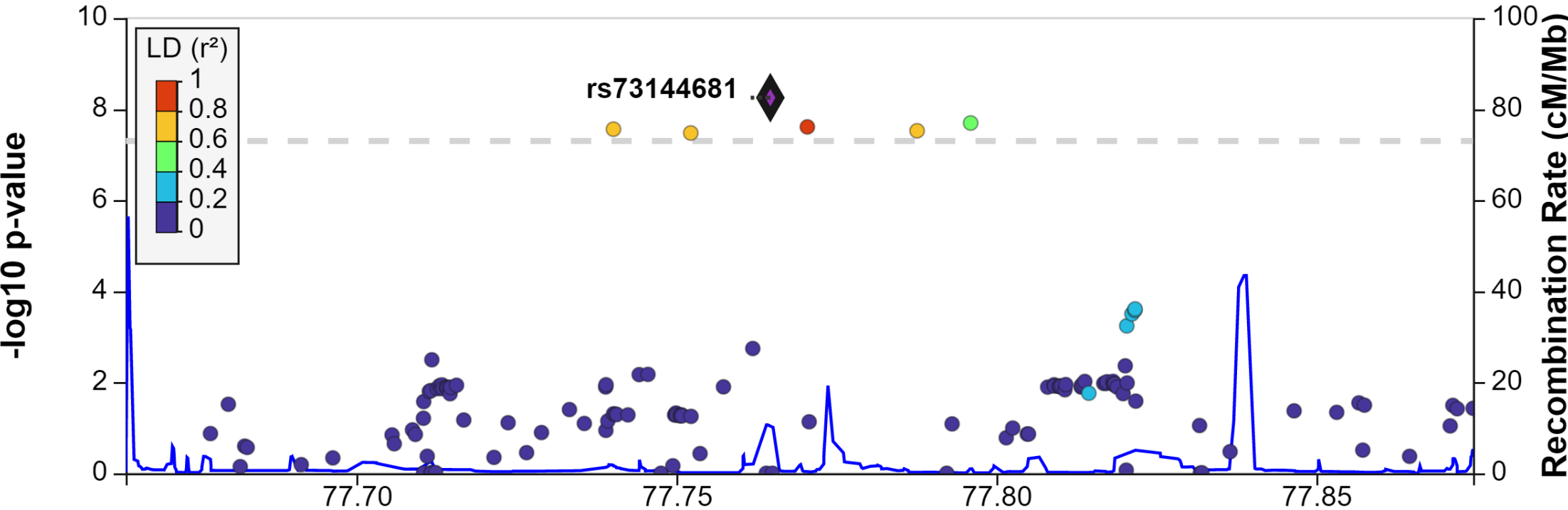

ADHDxCUD GWAS

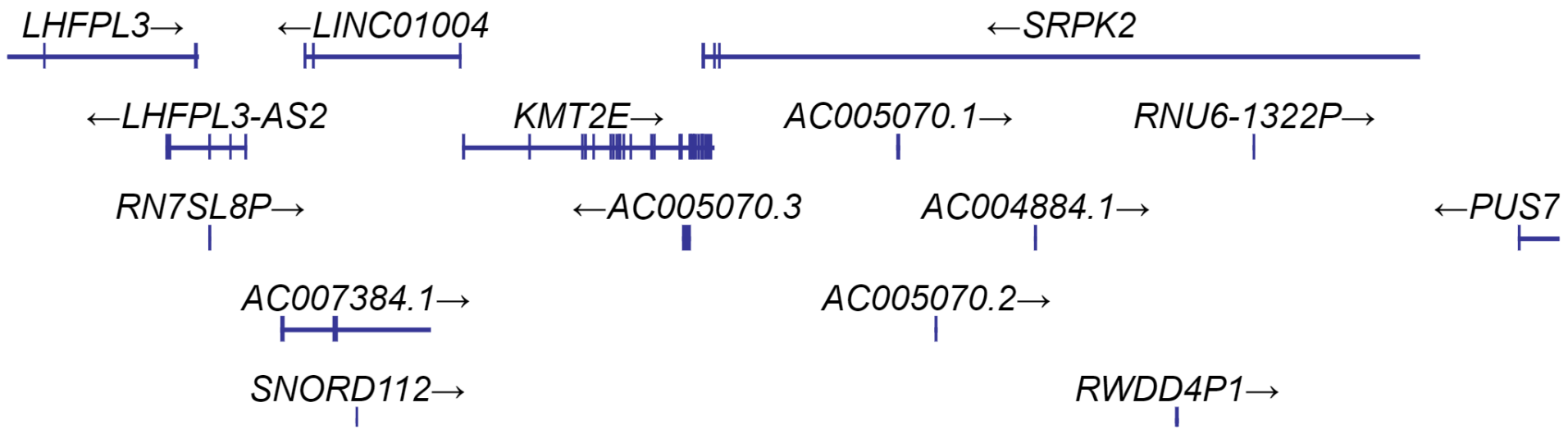
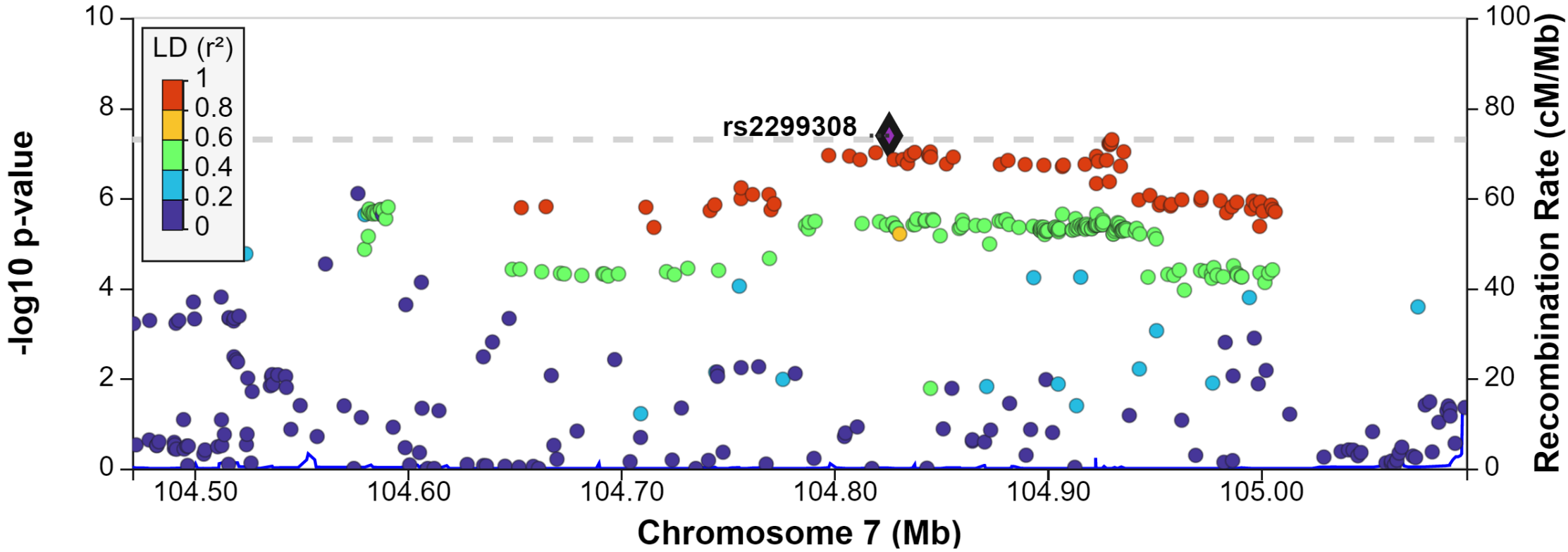

ADHDxCUD GWAS

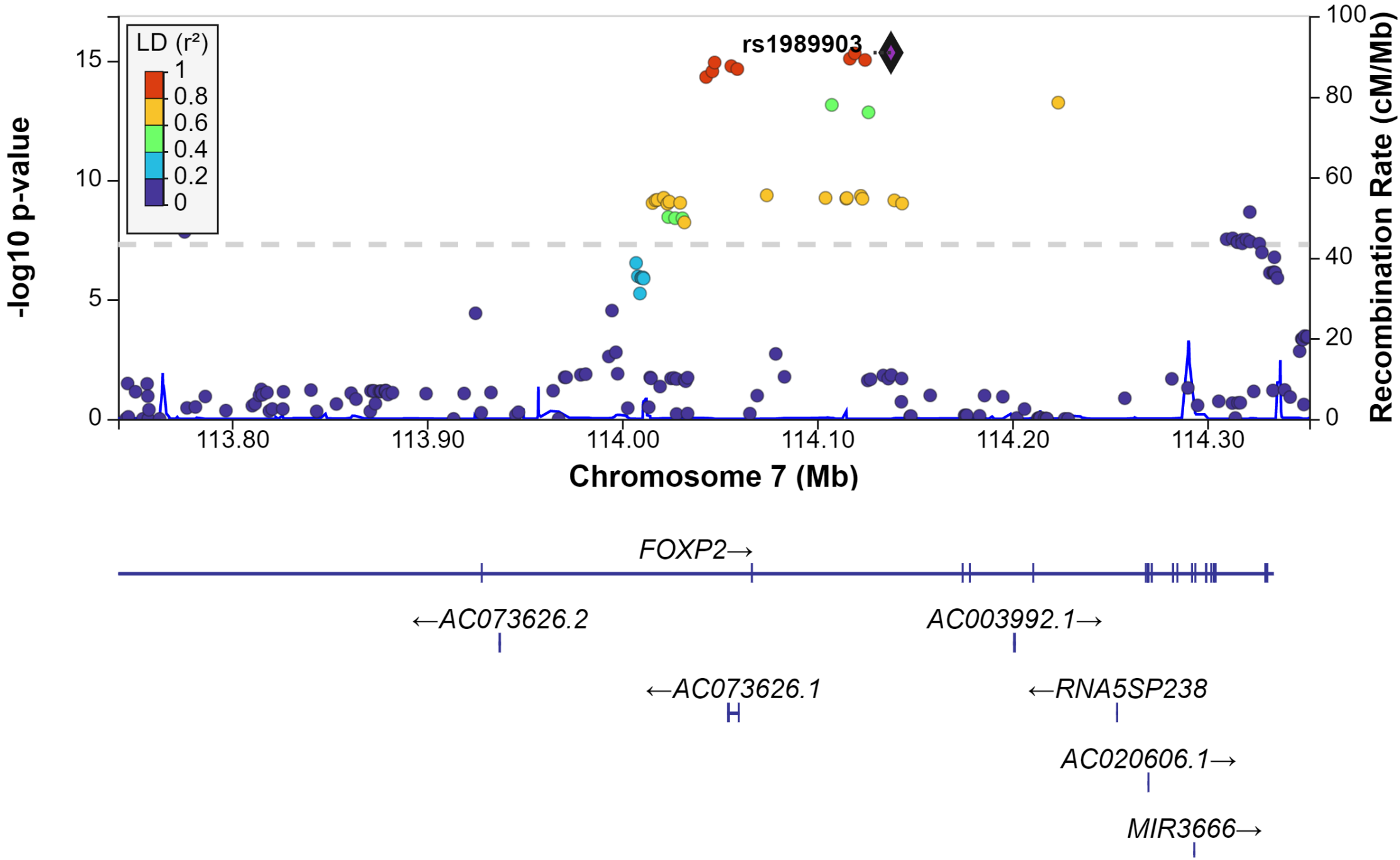

ADHDxCUD GWAS

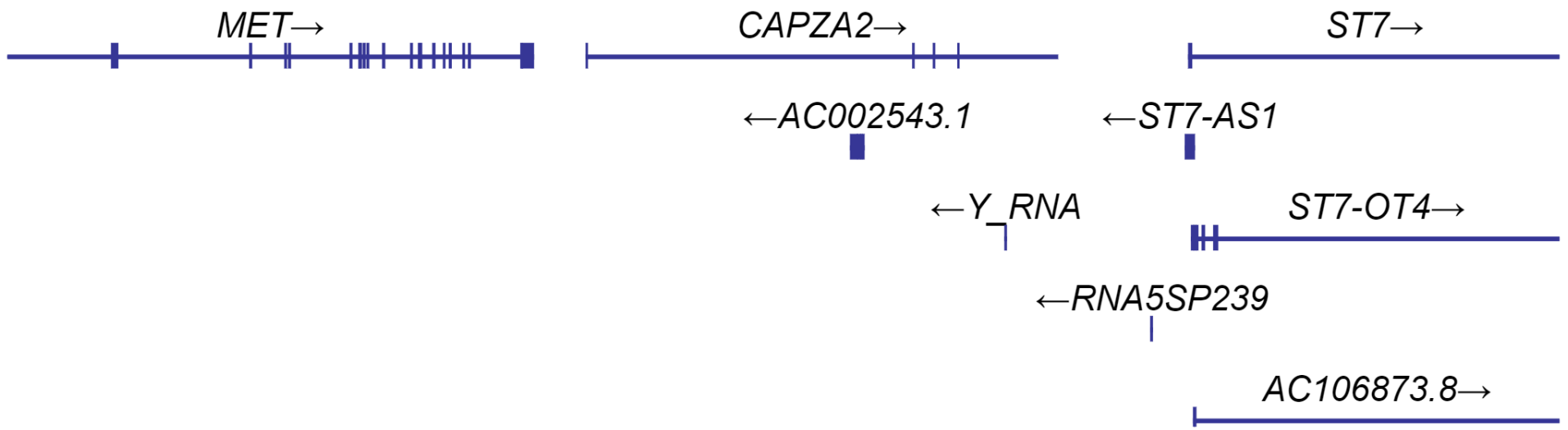
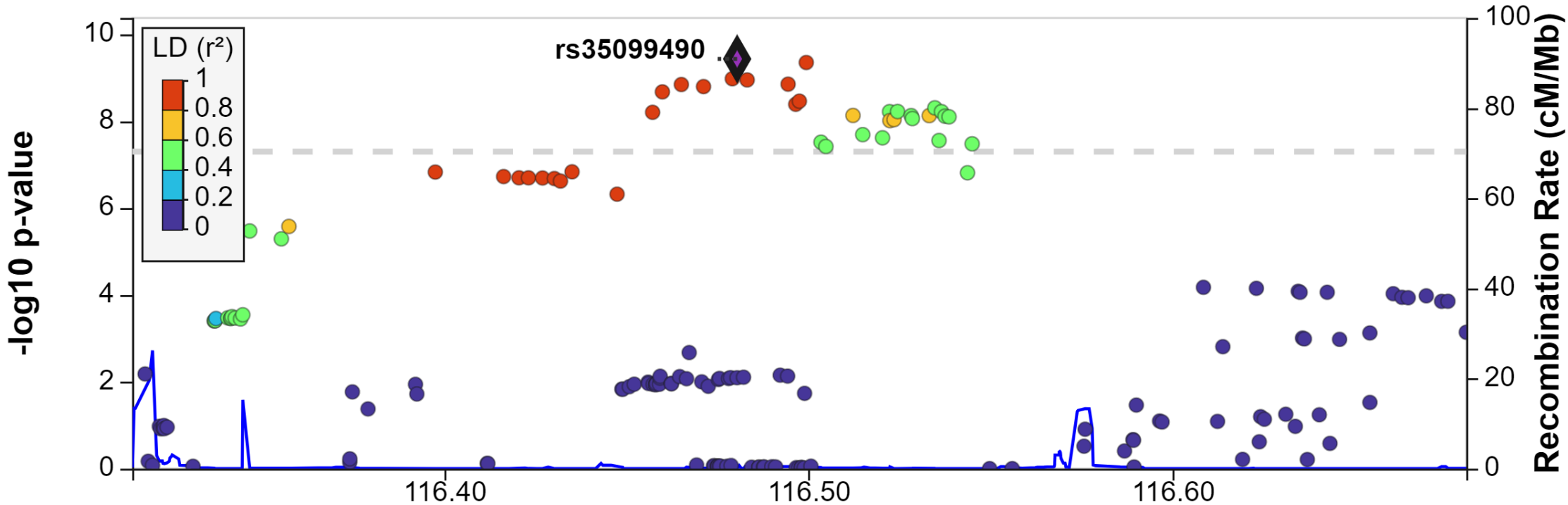

ADHDxCUD GWAS

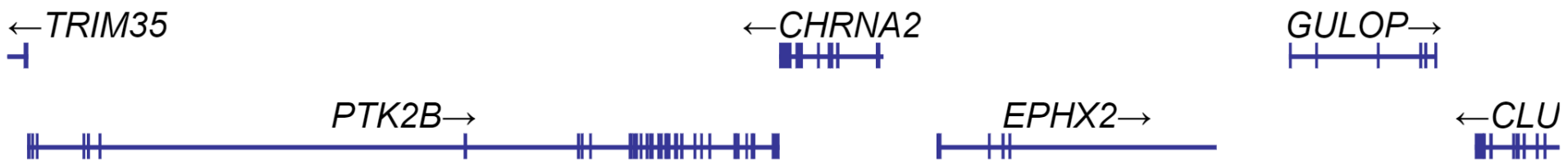
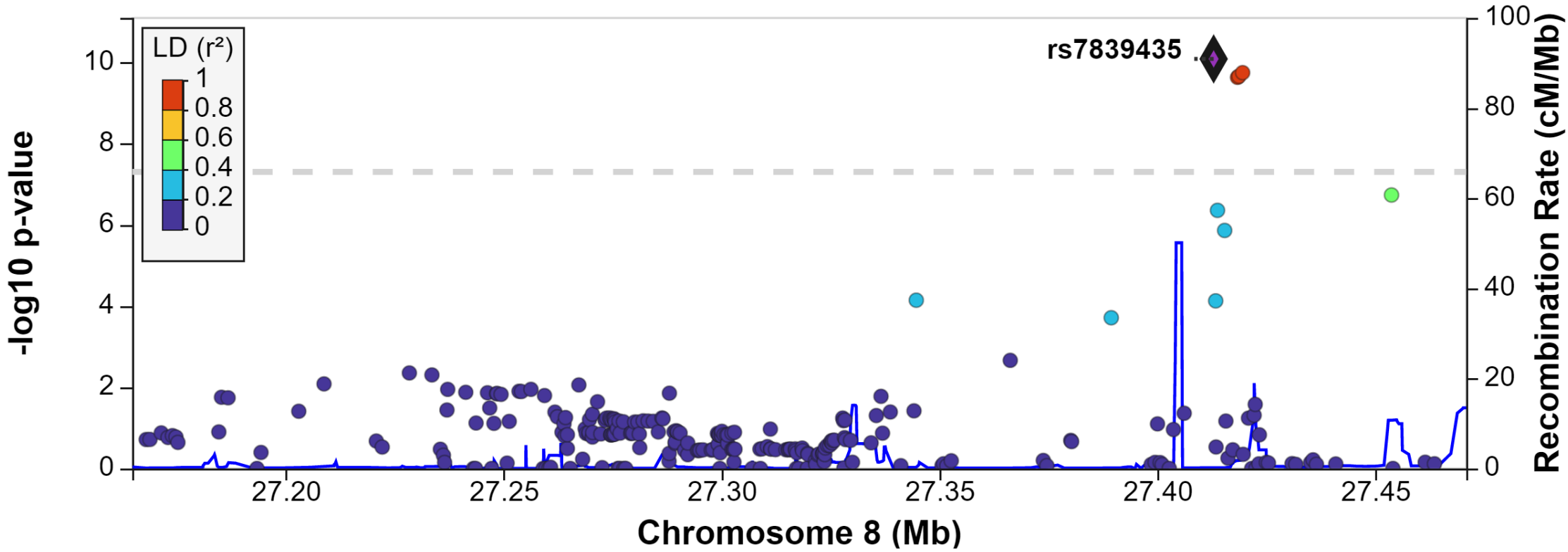

ADHDxCUD GWAS

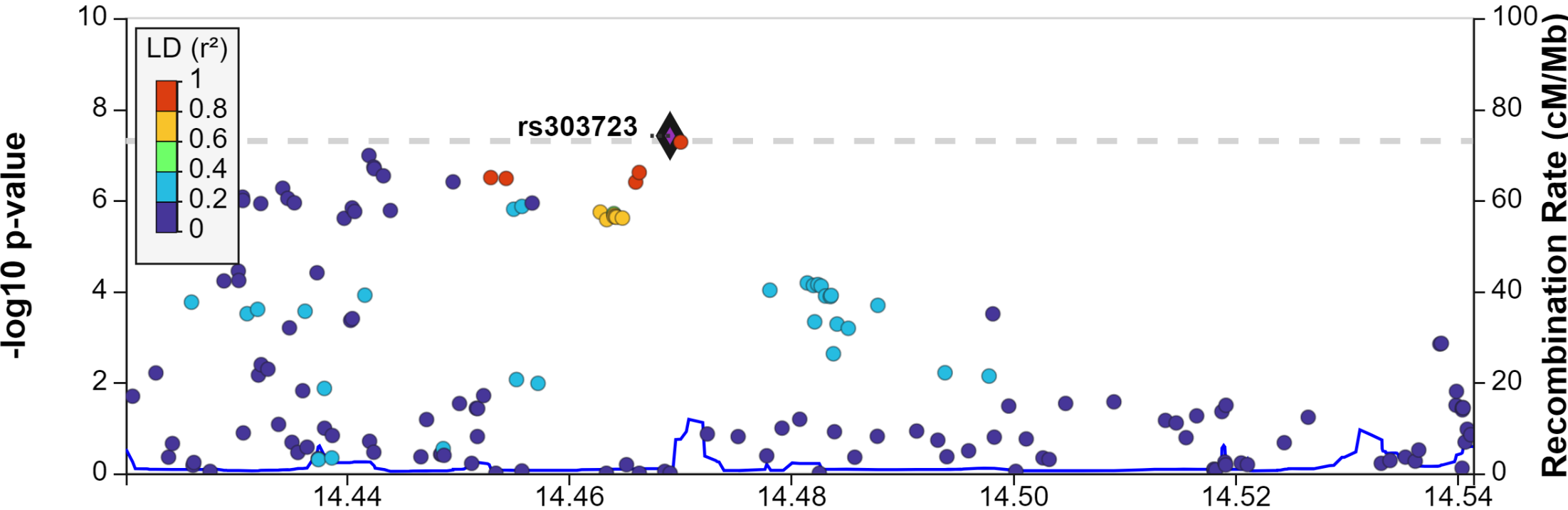

AL137017.1 →

← *AL159169.1*



ADHDxCUD GWAS

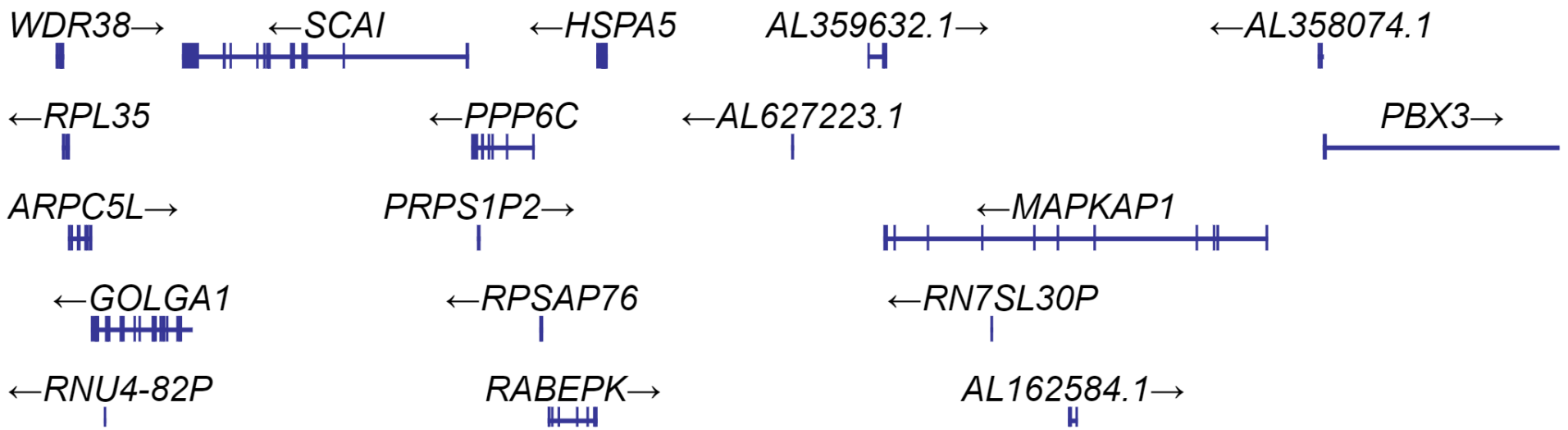
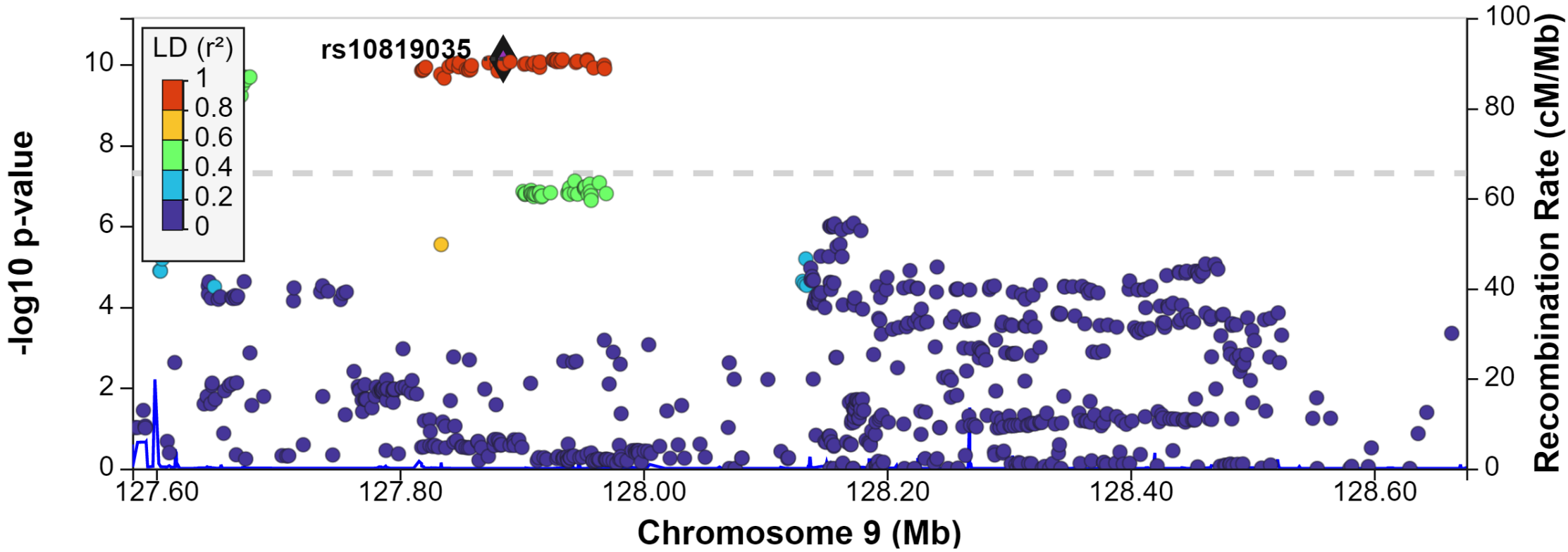

ADHDxCUD GWAS

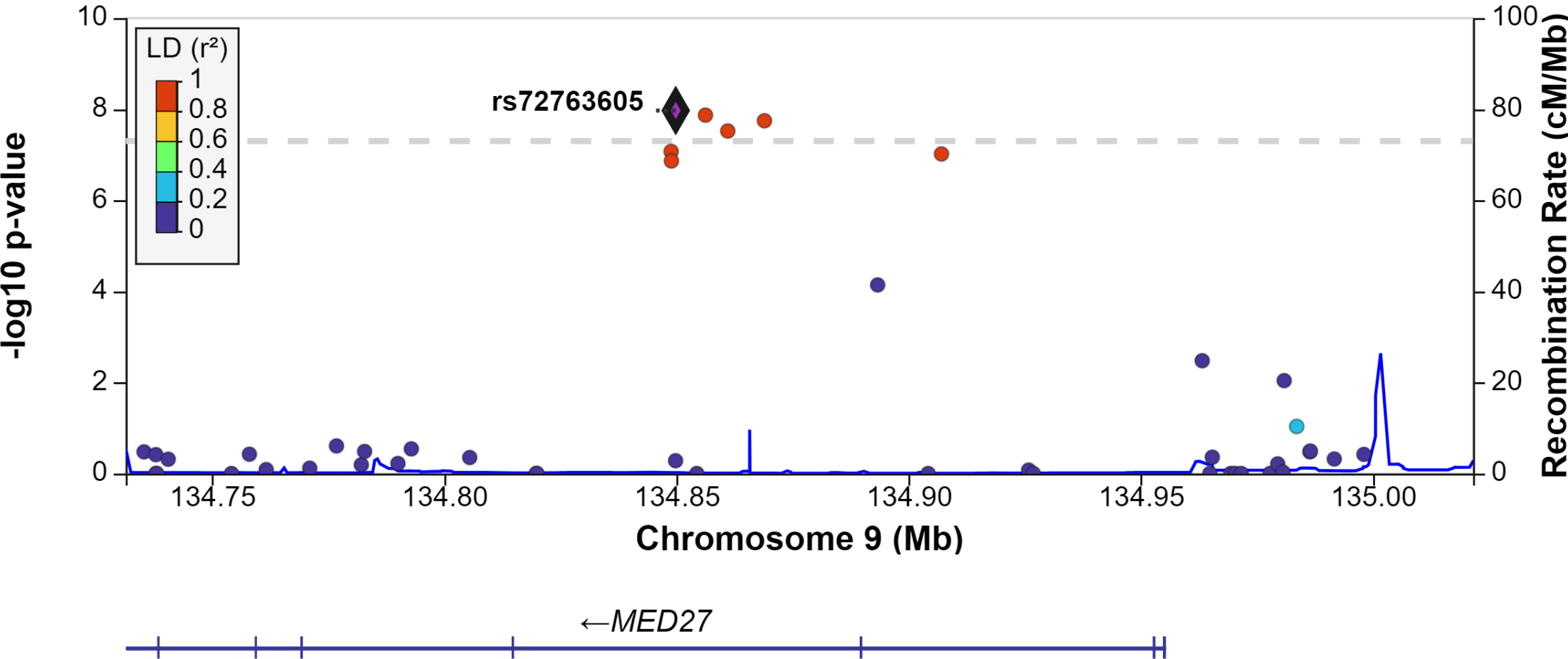

ADHDxCUD GWAS

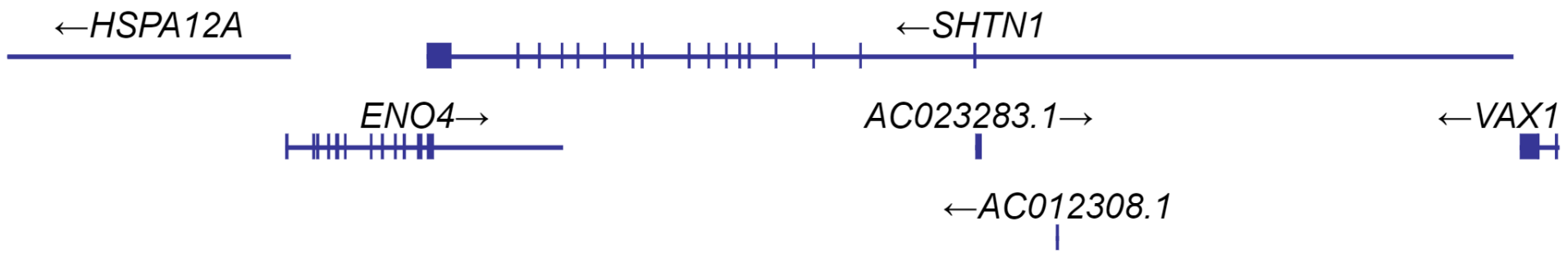
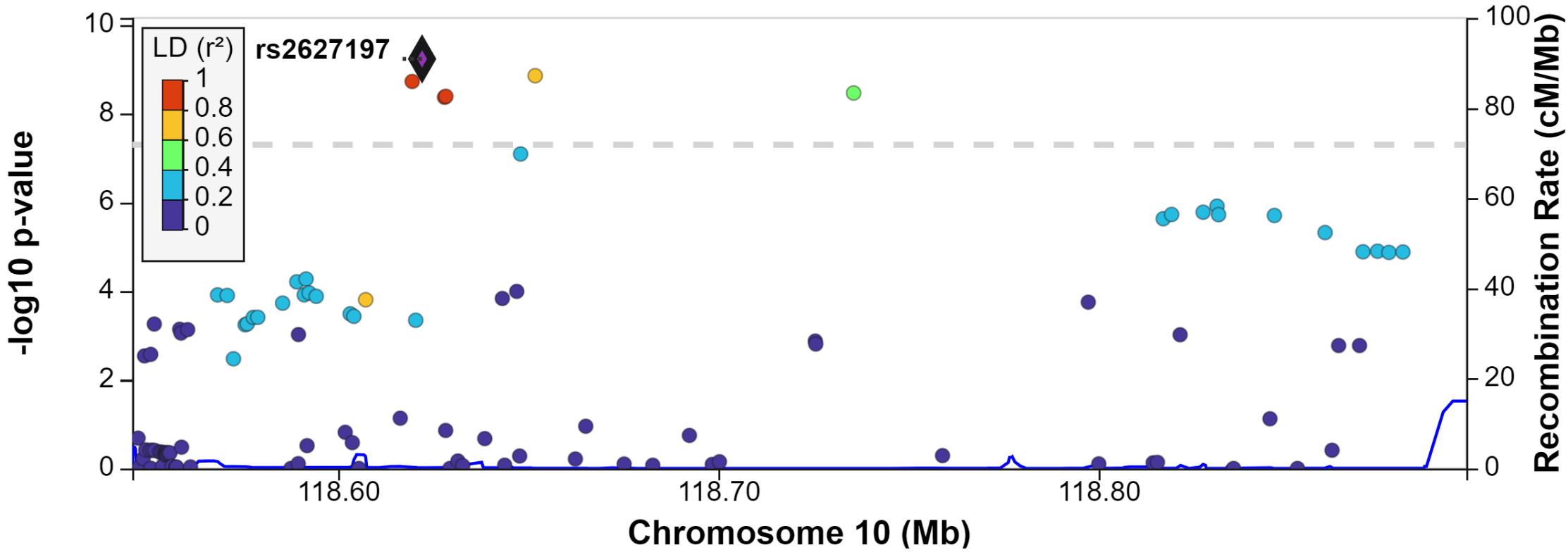

ADHDxCUD GWAS

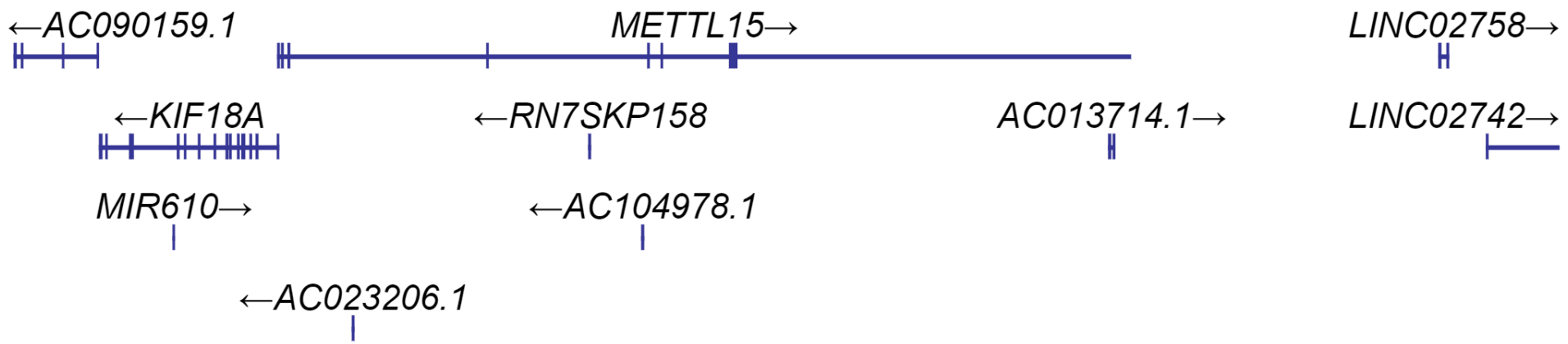
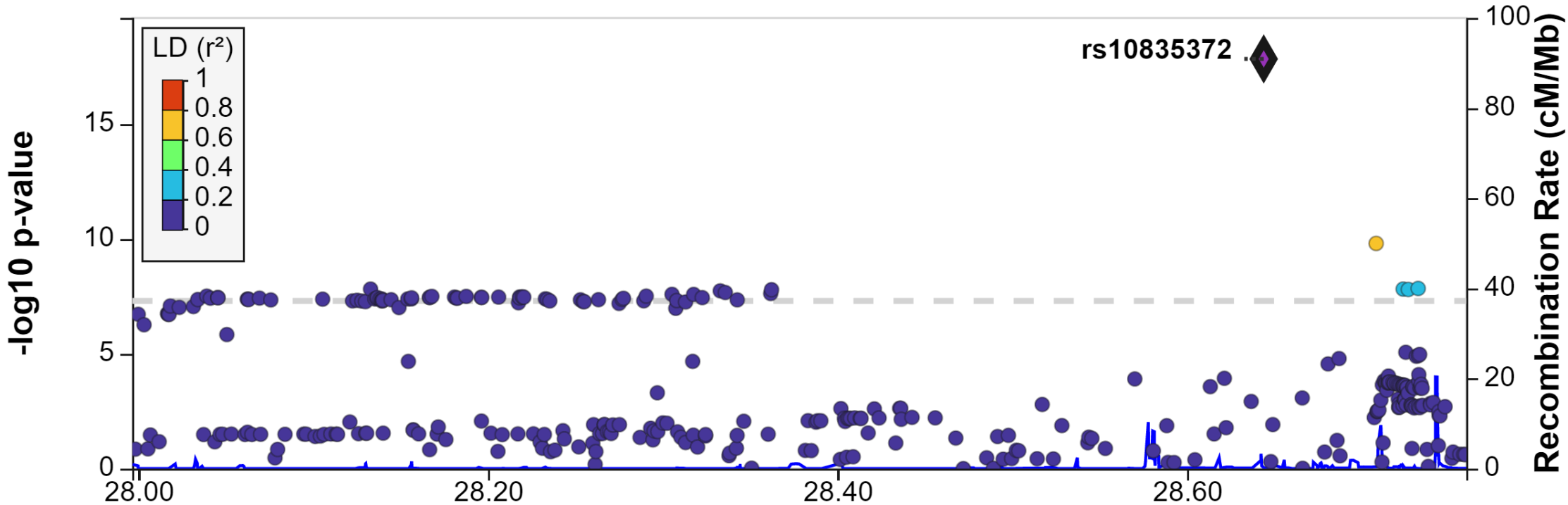

ADHDxCUD GWAS

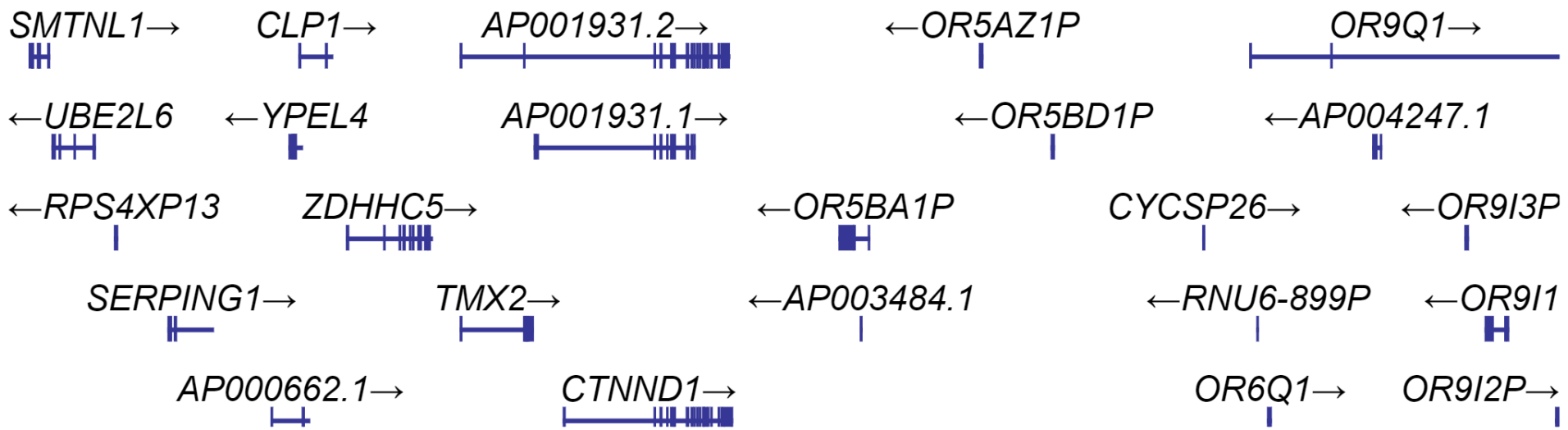
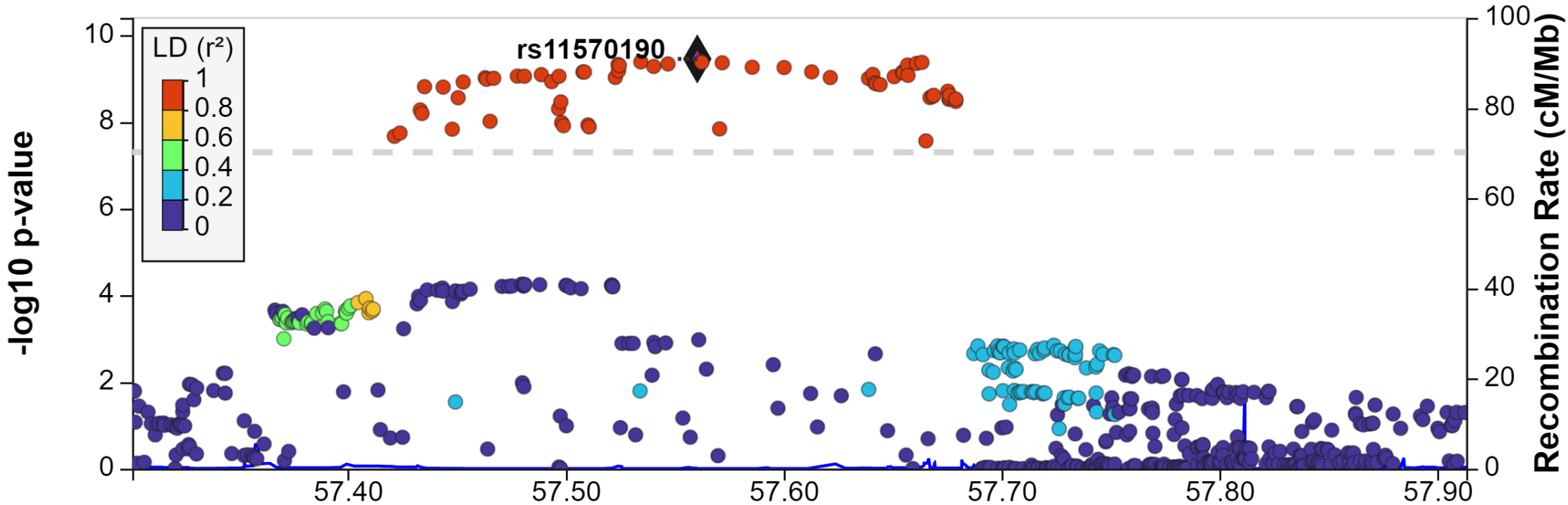

ADHDxCUD GWAS

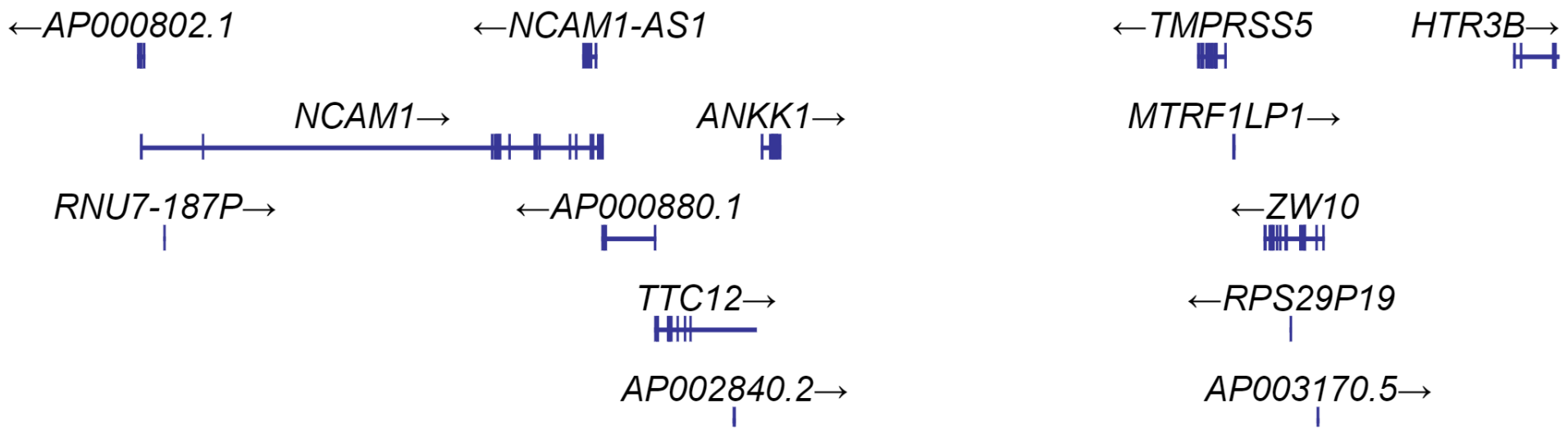
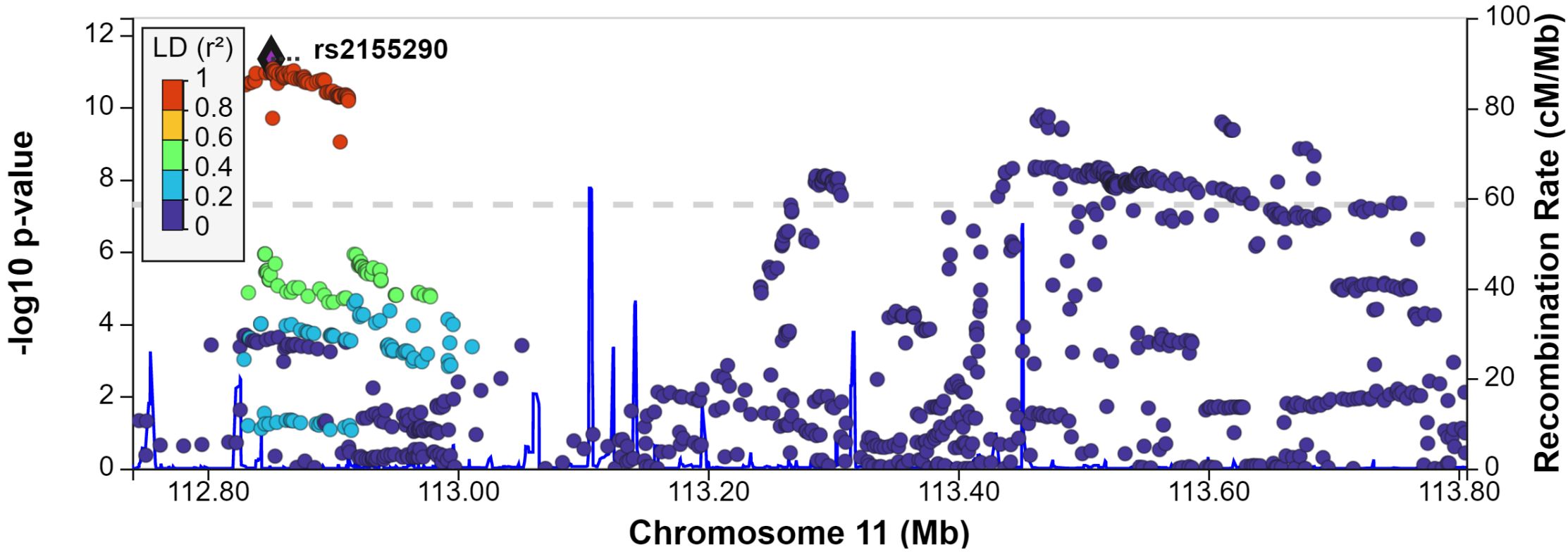

ADHDxCUD GWAS

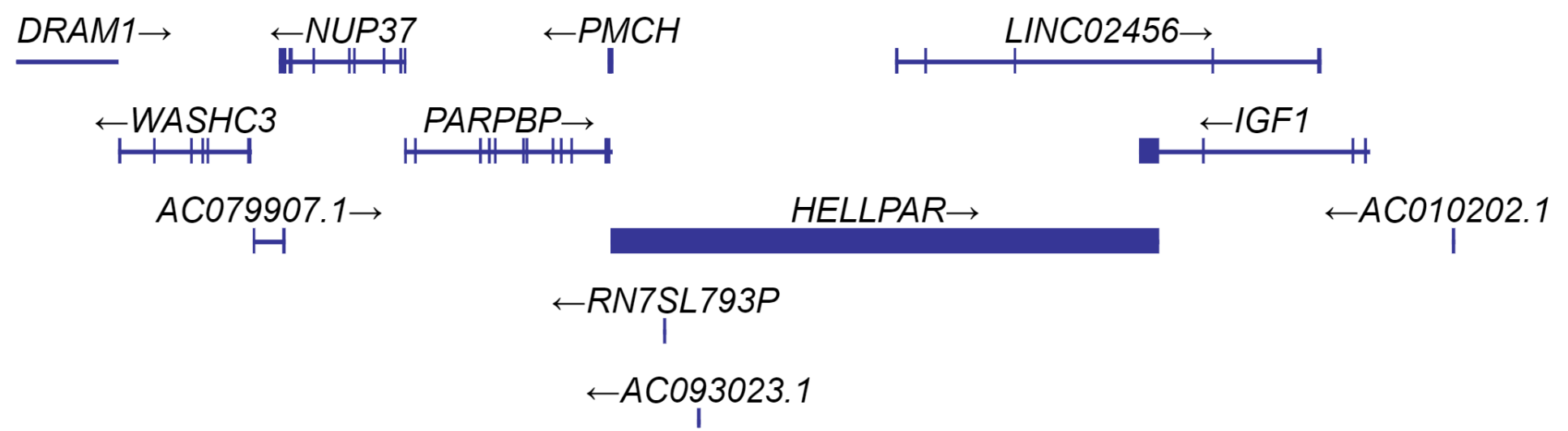
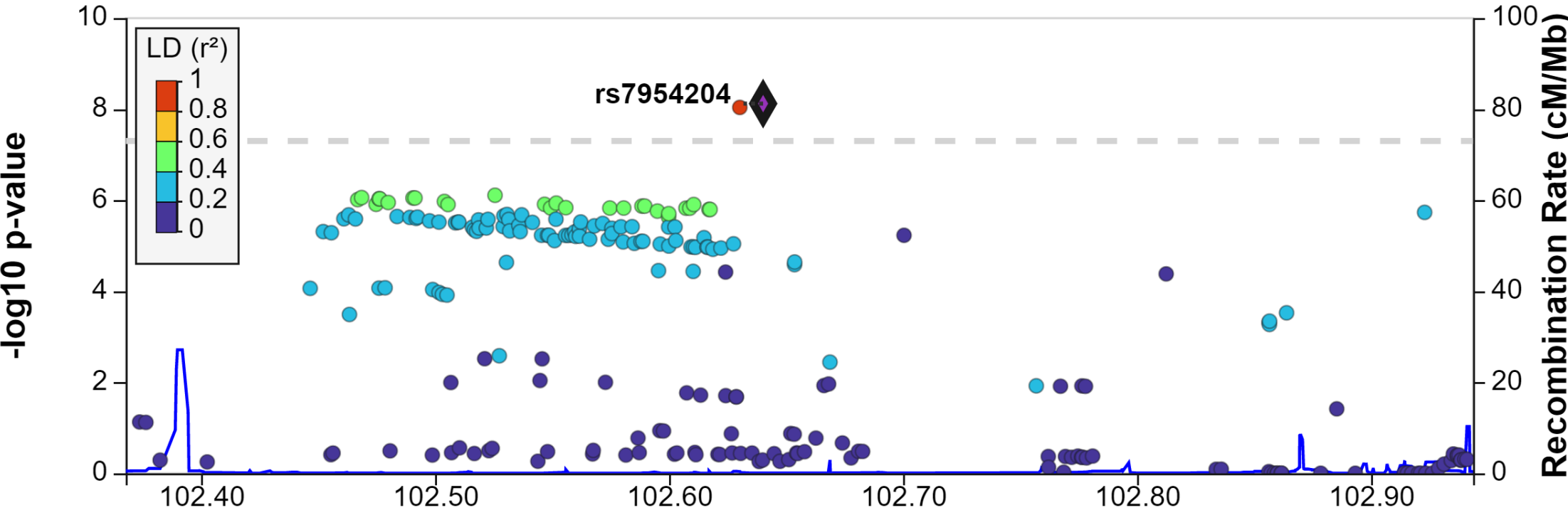

ADHDxCUD GWAS

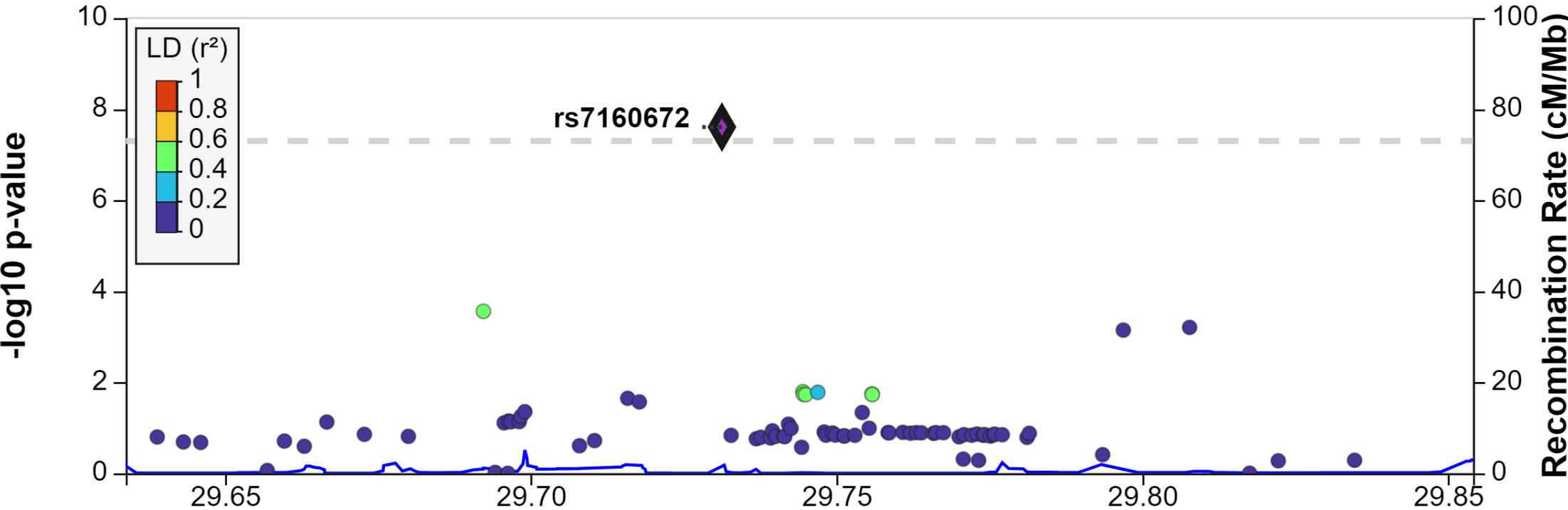

AL135878.1 →

← *AL133166.1*

ADHDxCUD GWAS

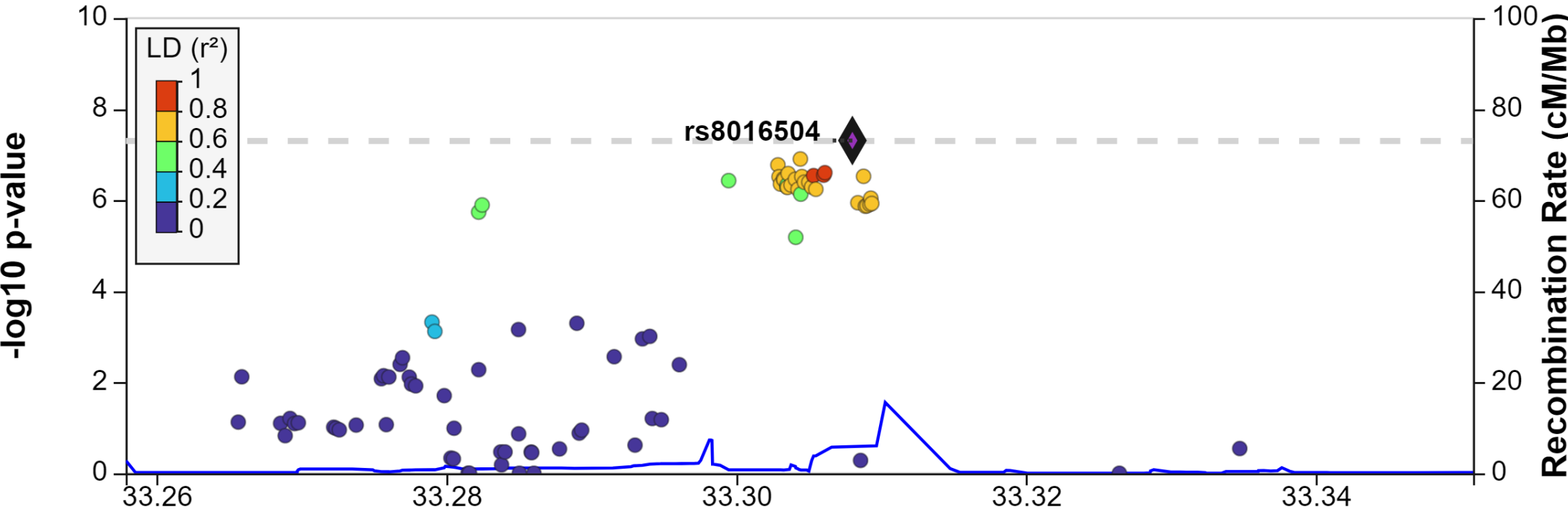

AKAP6→

AL049781.1→



ADHDxCUD GWAS

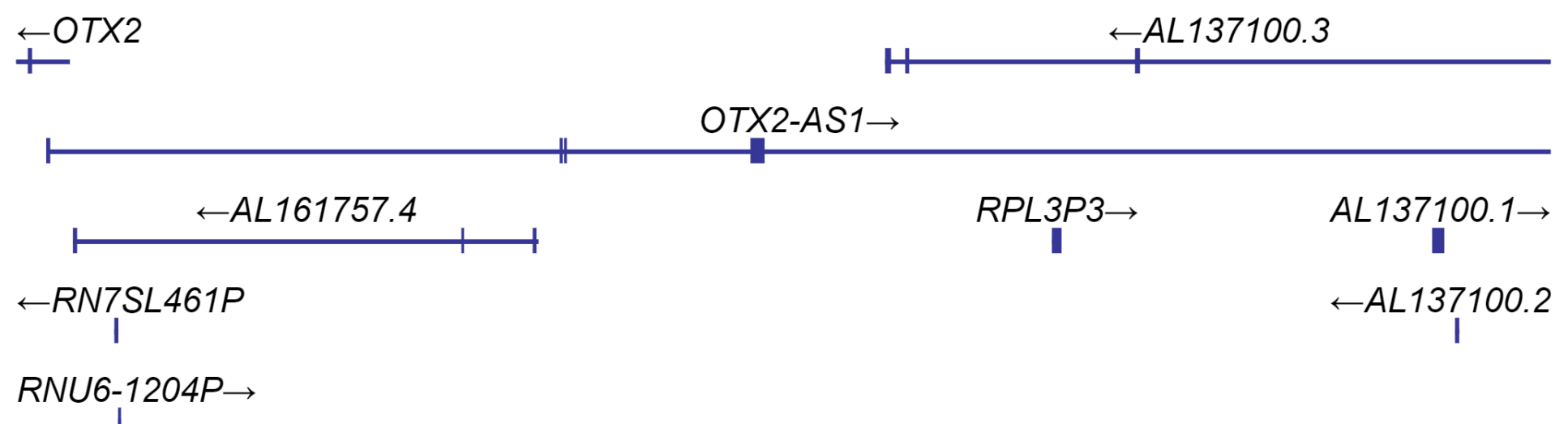
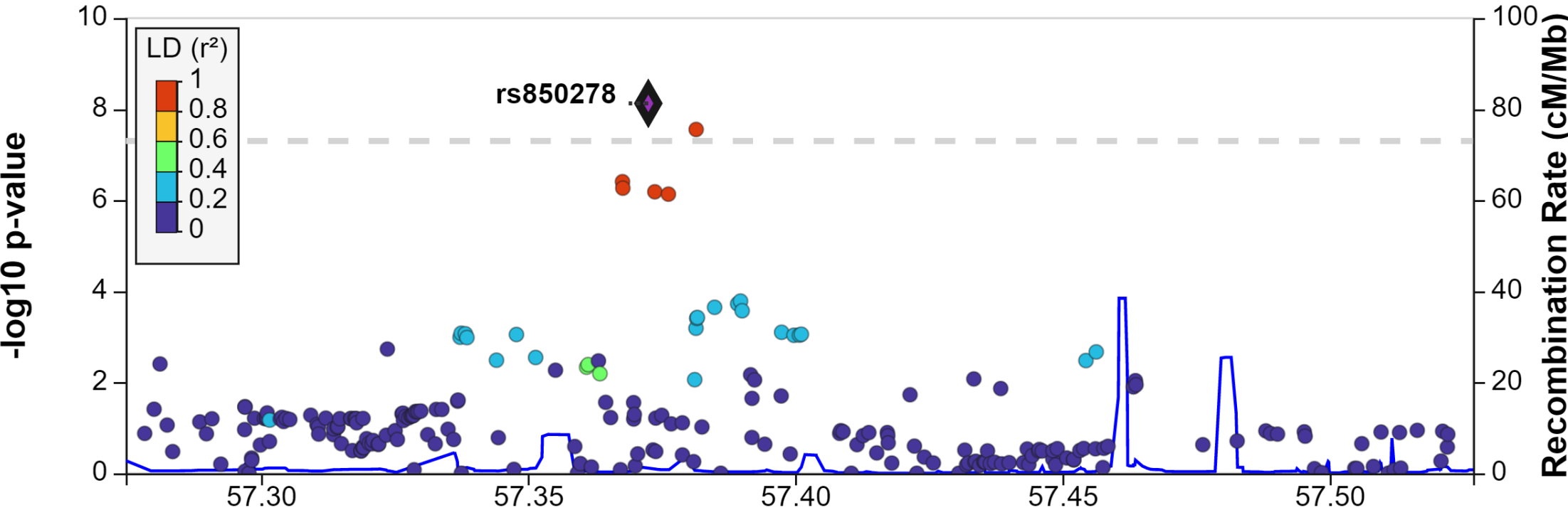

ADHDxCUD GWAS

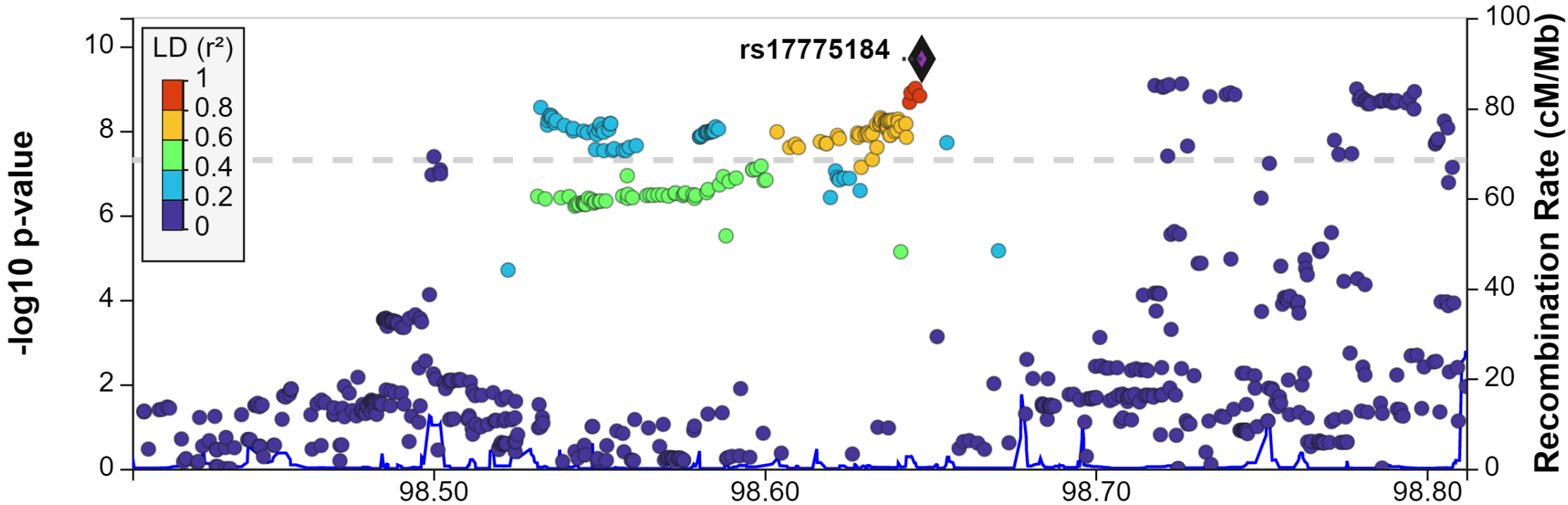

← *LINC01550*



← *AL163932.1*



LINC02295 →



← *AL163760.1*



ADHDxCUD GWAS

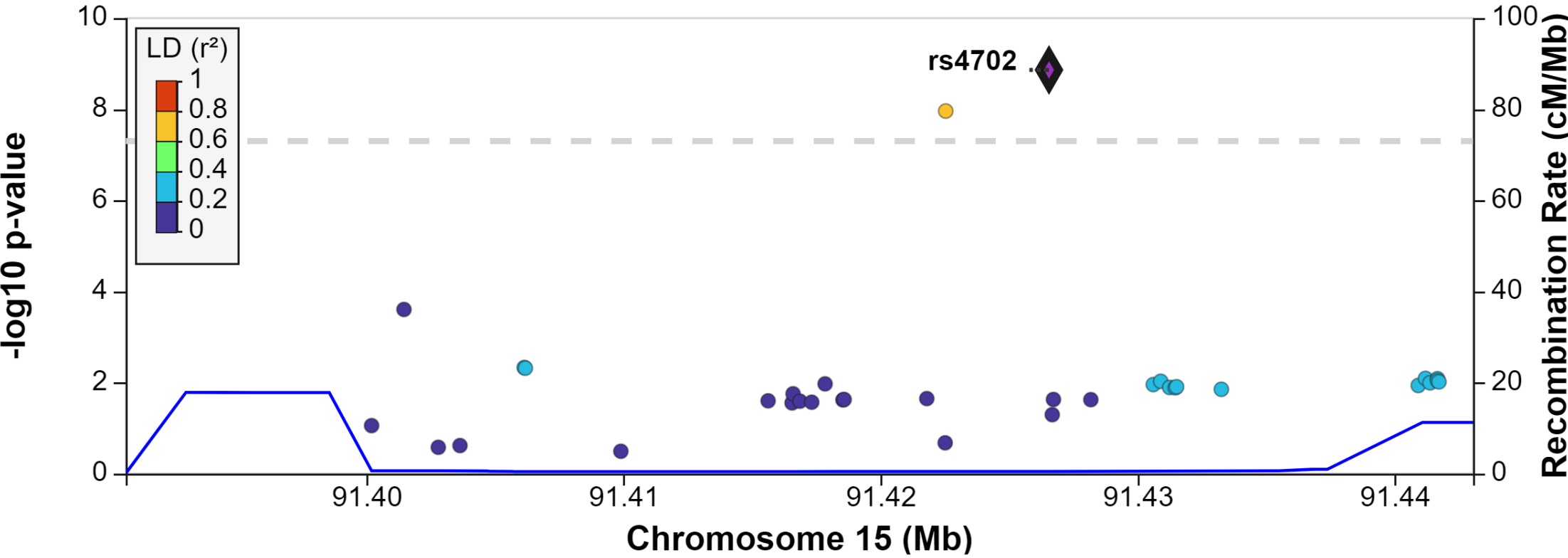

AC124248.1 →

← *RN7SL363P*

FURIN →

FES →

ADHDxCUD GWAS

