

# Ozone and ultra-fine particle concentrations in a hotel quarantine facility during 222 nm far-UVC air disinfection

Petri Kalliomäki<sup>1</sup>, Hamed Sobhani<sup>2</sup>, Phillip Stratton<sup>3,4</sup>, Kristen K. Coleman<sup>1</sup>, Aditya Srikakulapu<sup>1</sup>, Ross Salawitch<sup>3</sup>, Russell R. Dickerson<sup>3</sup>, Shengwei Zhu<sup>2</sup>, Jelena Srebric<sup>2</sup> and Donald K. Milton<sup>1</sup>

<sup>1</sup>University of Maryland, School of Public Health, College Park, MD, USA

<sup>2</sup>University of Maryland, Department of Mechanical Engineering, College Park, MD, USA

<sup>3</sup>University of Maryland, Department of Atmospheric & Oceanic Science, College Park, MD, USA

<sup>4</sup>Air Resources Laboratory, National Oceanic and Atmospheric Administration (NOAA), College Park, MD, USA

## Abstract

Far-UVC (222 nm UV-C light) is a promising tool to mitigate aerosol transmission of pathogens indoors. However, recent studies have raised concerns related to ozone (O<sub>3</sub>) production and secondary chemistry. In this study, we measured indoor O<sub>3</sub> and ultra-fine particle (UFP, 17.5-289 nm) concentrations with and without 222 nm far-UVC (average fluence rate 1.7-1.8 μW/cm<sup>2</sup>) in a hotel quarantine facility in Baltimore (MD, USA). We obtained nearby outdoor O<sub>3</sub> concentrations from the Environmental Protection Agency (EPA) website. In a sealed empty guest room, the average O<sub>3</sub> concentrations were 3 ppb (UV off, 0.1-0.5 ACH), 16 ppb (UV on, 0.1 ACH) and 9 ppb (UV on, 0.5 ACH). In a standard guest room, the average O<sub>3</sub> concentrations were 12 ppb (UV off, 1.4 ACH) and 14 ppb (UV on, 1.4 ACH), and correlated with outdoor concentrations ( $\rho = 0.65 - 0.74$ ,  $p = 2 \times 10^{-12} - 2 \times 10^{-29}$ ). A linear regression model, adjusted for outdoor O<sub>3</sub>, estimated that use of far-UVC lamps increased the O<sub>3</sub> concentration by 5.7 ppb (95% confidence interval (CI) 4.9 – 6.5 ppb) in the standard hotel room. Indoor O<sub>3</sub> concentrations increased with far-UVC usage, however, the concentrations remained 6-12 ppb lower, on average, than outdoors and well below EPA ambient limits. We did not find a clear relationship between indoor UFP concentrations and UV usage. Although our study was limited by absence of direct outdoor measurements of local O<sub>3</sub> and UFPs, our findings do not support a major impact of far-UVC on UFP concentrations in the real-world environment that we studied.

## 31 1. Introduction

32 Hotels have been used as quarantine facilities to mitigate the spread of severe acute respiratory  
33 syndrome coronavirus 2 (SARS-CoV-2) in many countries during the coronavirus disease (COVID-19)  
34 pandemic. Although individuals are quarantined in separate rooms, cross infections and intra-hotel  
35 clusters have been reported<sup>1-5</sup>, some leading to community outbreaks and lockdowns<sup>5,6</sup>. Such failed  
36 attempts to contain SARS-CoV-2 underscore the importance of adequate ventilation, filtration, and air  
37 disinfection to mitigate pandemic respiratory virus transmission.

38 One effective mitigation measure for aerosol transmission of infections is germicidal ultraviolet  
39 (GUV) air disinfection<sup>7-10</sup>. It is a well-established method and has been used for several decades<sup>11</sup>.  
40 Traditionally, 254 nm UV light (upper-room GUV)<sup>12-14</sup> has been the GUV wavelength used in indoor  
41 environments. However, usage of 254 nm UV light is typically limited to upper-room or in-duct  
42 applications as direct exposure can cause damage to eyes and skin<sup>15-16</sup> (depending on the UV intensity  
43 and duration of the exposure). An alternative GUV wavelength, 222 nm far-UVC, has gained popularity in  
44 air disinfection and has been studied intensively, especially since the beginning of the COVID-19  
45 pandemic. It is better tolerated by eyes and skin<sup>17,18</sup> (compared with conventional 254 nm GUV) and  
46 effectively inactivates multiple pathogens, including SARS-CoV-2<sup>19-22</sup>. Due to better tolerance, 222 nm far-  
47 UVC can be used in occupied zones of indoor environments and hence has the potential, for example, to  
48 reduce close-range transmission more effectively than upper-room GUV.

49 However, health concerns have been raised related to far-UVC usage. Recent studies have shown  
50 that 222 nm far-UVC produces O<sub>3</sub> and secondary chemistry that can notably affect indoor air quality,  
51 particularly in spaces with low ventilation<sup>23-27</sup>. However, these studies are mostly limited to modelling  
52 cases and laboratory experiments with only a limited number of studies investigating far-UVC generated  
53 O<sub>3</sub> and ultra-fine particulate matter in real-world settings where far-UVC air disinfection would be  
54 recommended as an added layer of protection, such as in hotel quarantine facilities and other high-risk  
55 indoor venues<sup>28</sup>. In this preliminary study, we take advantage of ongoing influenza transmission research  
56 to examine O<sub>3</sub> and ultra-fine particle (UFP) concentrations in a hotel quarantine facility with and without  
57 222 nm far-UVC.

## 58 2. Methods

### 59 2.1. Research site

60 This study was performed in a 23-story hotel building in downtown Baltimore (MD, USA). The hotel was  
61 used as a quarantine facility during the COVID-19 pandemic, and currently in ongoing influenza  
62 transmission research. The hotel has a centralized ventilation system that supplies outdoor air to the  
63 hallways and extracts the air through exhaust grilles in the bathrooms. The guest rooms have thermostat  
64 and motion sensor-controlled fan coil units for heating or cooling the room air (designed only to  
65 recirculate the room air). The fan coil units had MERV 13 filters. All guest room windows were locked and  
66 could not be opened to increase ventilation. Two rooms on the 14<sup>th</sup> floor were used in this study, both  
67 equipped with portable HEPA filter units (Breathsmart 45i, Alen, TX, USA, max. CADR 245 CFM). The  
68 HEPA units were run constantly on the highest fan speed to ensure good mixing. We used the HEPA filter  
69 and fan coil units with and without the filters as part of testing the effect of filtering on particle  
70 concentrations.

#### 71 2.1.1. Sealed unfurnished hotel room

72 The first room, referred to as the “sealed room”, was a large guest room suite (38 m<sup>2</sup>) on the north side  
73 of the building. The room had vinyl flooring and was unfurnished (i.e., no bedding or desks) aside from  
74 plastic chairs and tables to place sampling equipment (see Figure 1). The room had a dehumidifier  
75 (HomeLabs HME020031N, NY, USA) to control relative humidity (RH, set point at 35%). We sealed door  
76 gaps, taped window joints and covered the windows with plastic sheets to ensure minimal ventilation  
77 and outdoor infiltration. Hence the room had a low ventilation rate between 0.1-0.5 air changes per  
78 hour (ACH), see Supporting Information for more details. The average air temperature and RH during the  
79 measurements were 21.1°C and 35.3%, respectively. The room had four 222 nm far-UVC light fixtures  
80 (Krypton Shield, Far-UV Inc., MO, USA) each with Krypton-Chloride excimer lamp modules (B1 module,  
81 Ushio Inc, Japan). When on, the average fluence rate in the sealed room was modeled to be 1.8 μW/cm<sup>2</sup>  
82 (see Supporting Information for more details).

#### 83 2.1.2. Standard hotel room

84 The other room, referred to as the “standard room”, was a furnished single guest room (21 m<sup>2</sup>) on the  
85 south side of the building. The room was fully furnished with a king bed, two desks, and carpet flooring  
86 (see Figure 2). We used the room under typical operating conditions and did not seal window joints,

87 door gaps, etc. The average air exchange rate of the room was 1.4 ACH and it varied between 1.2 to 1.7  
88 ACH (see Supporting Information for more details). The average air temperature and RH during the  
89 measurements were 22.8°C and 23.6%, respectively. The room had three 222 nm far-UVC light fixtures  
90 (Krypton Shield, Far-UV Inc., MO, USA), two with Ushio B1 modules and one with B1.5 module (Ushio  
91 Inc, Japan). When on, the average UV fluence rate in the standard room was modeled to be 1.7  $\mu\text{W}/\text{cm}^2$   
92 (see Supporting Information for more details).

## 93 2.2. Measurements

### 94 2.2.1. *O<sub>3</sub> measurements*

95 We used an O<sub>3</sub> monitor (TE49C, Thermo Environmental Instruments, MA, USA) to measure O<sub>3</sub>  
96 concentrations inside the rooms. The concentrations were measured with 10-s resolution and later  
97 averaged over 1-min and 1-h intervals. The instrument was calibrated against a reference monitor  
98 (Model TE49i-PS Ozone Primary Standard) that was compared to a reference instrument at the National  
99 Institute of Standards and Technology (NIST, USA). The absolute accuracy of the instrument is  
100 approximately 4 ppb at 10-s resolution and 2 ppb for hourly averages (95% Confidence Interval (CI)).

101 Outdoor O<sub>3</sub> concentration data (1-h resolution) was downloaded from the Environmental  
102 Protection Agency (EPA) website ([https://aq.s.epa.gov/aqsweb/documents/data\\_api.html](https://aq.s.epa.gov/aqsweb/documents/data_api.html)). We included  
103 data from the three closest monitoring stations (12-19 km from the hotel) around the Baltimore  
104 metropolitan area in our analysis (which had the highest data coverage during the time of the  
105 measurements). Average O<sub>3</sub> concentration (of the three outdoor locations) was used in the final  
106 analyses.

### 107 2.2.2. *Ultra-fine particle measurements*

108 We used a scanning mobility particle sizer (SMPS 3938, DMA 3081A, CPC 3756, TSI Inc., MN, USA) to  
109 monitor UFP concentrations within the size range of 17.5-289 nm. The sampling resolution of the SMPS  
110 system was 66 s.

### 111 2.2.3. *CO<sub>2</sub> measurements*

112 We monitored ventilation by releasing carbon dioxide (CO<sub>2</sub>) into the rooms at a constant 0.4 L/min rate  
113 (GFC171S mass flow controller, Aalborg Instruments & Controls Inc., NY, USA). We used wireless sensors  
114 (Aranet4, SAF Tehnika JSC, Latvia) to measure CO<sub>2</sub> concentrations in the rooms, hallways and outdoors  
115 (1-min resolution). The sensors were calibrated with a standard CO<sub>2</sub> gas with a range of concentrations

116 between 500-10,000 ppm. The CO<sub>2</sub> sensor accuracy is  $\pm 30$  ppm or  $\pm 3\%$  of the reading (according to the  
117 manufacturer). The sensors also measured ambient temperature, RH, and barometric pressure.

### 118 2.3. Data collection and analysis

119 We carried out measurements in the sealed room between Feb 17<sup>th</sup> – Feb 20<sup>th</sup>, 2023 (O<sub>3</sub> between Feb  
120 16<sup>th</sup>-20<sup>th</sup>, 2023) and in the standard room between Feb 27<sup>th</sup> – Mar 10<sup>th</sup>, 2023. All data were cleaned  
121 (occupied periods removed from the data, etc.) and analyzed with MATLAB. One-hour averages of the  
122 data were used in final analyses. Linear regression models were calculated using fitlm-function in  
123 MATLAB.

## 124 3. Results

### 125 3.1. CO<sub>2</sub> and O<sub>3</sub> concentrations in the sealed hotel room

126 CO<sub>2</sub> and O<sub>3</sub> concentrations in the sealed room are shown in Figure 3. Constant injection of 0.4 L/min CO<sub>2</sub>  
127 produced two steady-state levels with concentrations of c. 1060 ppm and c. 2400 ppm. We observed  
128 that the fan coil units were pulling air into the room from the pipe chase. Consequently, the average air  
129 exchange rate in the sealed room was calculated to be 0.1 ACH and 0.5 ACH when the fan coil units were  
130 off and on, respectively. We did not see a similar effect in the standard room.

131 When the far-UVC lamps were off, the average O<sub>3</sub> concentration was 3 ppb in the sealed room  
132 and 32 ppb outdoors at 0.1 ACH (fan coils off), and 3 ppb indoors and 29 ppb outdoors at 0.5 ACH (fan  
133 coils on). When the UV lamps were on, the average O<sub>3</sub> concentration was 16 ppb indoors and 22 ppb  
134 outdoors at 0.1 ACH (fan coil units off), and 9 ppb indoors and 16 ppb outdoors at 0.5 ACH (fan coil units  
135 on). In general, O<sub>3</sub> concentrations in the sealed room showed a clear build-up and decay in relationship  
136 to operation of the far-UVC lamps and the fan coil units.

137 Indoor O<sub>3</sub> concentrations in the sealed room (at 0.1 ACH) were strongly correlated (Spearman's  
138 rank correlation  $\rho$ ) with outdoor concentrations (Figure 4a) both with far-UVC lamps off ( $\rho = 0.88$ ,  $p =$   
139  $7 \cdot 10^{-9}$ ) and on ( $\rho = 0.97$ ,  $p = 3 \cdot 10^{-10}$ ). When the fan coil units were on and the ventilation rate increased  
140 to 0.5 ACH, indoor O<sub>3</sub> was weakly to moderately correlated with outdoor concentrations when the far-  
141 UVC lights were off ( $\rho = 0.48$ ,  $p = 0.04$ ) or on ( $\rho = 0.38$ ,  $p = 0.06$ ) (Figure 4b).

### 142 3.2. CO<sub>2</sub> and O<sub>3</sub> concentrations in the standard hotel room

143 CO<sub>2</sub> and O<sub>3</sub> data collected from the standard hotel room is shown in Figure 5. The average CO<sub>2</sub>  
144 concentration was 840 ppm with notable fluctuations (range: 720 ppm to 1010 ppm). The fluctuations  
145 seemed to be driven by changing ventilation due to outdoor infiltration and occasional entry of  
146 researchers to check and operate equipment.

147 The average indoor O<sub>3</sub> concentration was 12 ppb when the far-UVC lamps were off and 14 ppb  
148 when the UV lamps were on. Average outdoor concentrations were 35 ppb and 26 ppb when the UV  
149 lamps were off and on, respectively. Indoor O<sub>3</sub> was moderately to strongly correlated with outdoor O<sub>3</sub>  
150 concentrations (Figure 6) when the UV lamps were off ( $\rho = 0.65$ ,  $p = 2 \times 10^{-12}$ ) or on ( $\rho = 0.74$ ,  $p = 2 \times 10^{-29}$ ).  
151 A linear regression model, adjusted for outdoor O<sub>3</sub> concentration, indicated that the usage of the UV  
152 lamps increased the indoor O<sub>3</sub> concentration by 5.7 ppb (95% confidence interval (CI) 4.9 – 6.5 ppb). A 1-  
153 ppb increase in outdoor O<sub>3</sub> was associated with a 0.33-ppb increase in indoor O<sub>3</sub> (95% CI 0.29 – 0.36).

### 154 3.3. UFP Concentrations

155 The total UFP concentration in the sealed room ranged from 87 #/cm<sup>3</sup> to 6262 #/cm<sup>3</sup> (UV off) and from  
156 110 #/cm<sup>3</sup> to 3884 #/cm<sup>3</sup> (UV on) with peaks seemingly unrelated to operation of the far-UVC lamps  
157 throughout the sampling period (see Figure 5). The total UFP concentration in the standard room ranged  
158 from 167 #/cm<sup>3</sup> to 2196 #/cm<sup>3</sup> (UV off) and from 155 #/cm<sup>3</sup> to 6012 #/cm<sup>3</sup> (UV on) with major  
159 fluctuations also seemingly unrelated to far-UVC usage throughout the sampling period.

160 UFP concentrations in the sealed room were, on average, lower and less variable than those in  
161 the standard room. The concentrations in both rooms were higher during far-UVC usage compared to  
162 times when the lights were off (Figure 7). Addition of filtration reduced the particle concentrations in  
163 both rooms. Simultaneous measurements of UFP in paired rooms and outdoors were not available.

164 In the standard room, with the far-UVC lamps off, the filtration reduced the average UFP counts  
165 from 1173 (95% CI 1023 – 1323) to 807 (95% CI 672 – 943). With the far-UVC lamps on, the filtration  
166 reduced the average UFP counts from 2425 (95% CI 2219 – 2630) to 760 (95% CI 563 – 957).

167 In a simple linear model, without adjustment for indoor or outdoor O<sub>3</sub>, UV in the standard room  
168 was associated with an increase in UFP (1019, 95% CI 747 – 1290) and filtration was associated with a  
169 decrease in UFP (-1276, 95% CI -1014 to -1537). Further analysis, however, indicated that the  
170 relationship between total particle number concentrations, UV, and O<sub>3</sub> was complex. In the absence of

171 UV, when adjusted for outdoor O<sub>3</sub> and filtration, increasing indoor O<sub>3</sub> was associated with increasing UFP  
172 concentrations (153 ppb<sup>-1</sup>, p = 3x10<sup>-9</sup>). However, when far-UVC lamps were on and we adjusted for  
173 outdoor O<sub>3</sub> and filtration, indoor O<sub>3</sub> was associated with decreasing UFP concentrations (-158 ppb<sup>-1</sup> p =  
174 2x10<sup>-13</sup>). Thus, other factors related to ventilation seemed to have major impacts on UFP concentrations.

## 175 4. Discussion

### 176 4.1. O<sub>3</sub> concentrations

177 Our findings suggest that 222 nm far-UVC usage increases indoor O<sub>3</sub> concentrations above levels typically  
178 found in buildings. For example, in the absence of indoor sources, indoor O<sub>3</sub> concentrations (in schools,  
179 offices, and residences) are typically around 4-6 ppb<sup>31</sup>. In our study, average O<sub>3</sub> concentrations in the  
180 standard hotel room were 12 ppb with UV off and 14 ppb with UV lamps on. When adjusted for outdoor  
181 O<sub>3</sub>, the increase of O<sub>3</sub> in the standard room during UV usage was estimated to be 5.7 ppb. This increase  
182 is similar to the ~6.5-ppb increase recently reported by Peng et al. (2023)<sup>26</sup>, who measured O<sub>3</sub> in a sealed  
183 office room with and without 222 nm far-UVC lamp usage. All measured indoor O<sub>3</sub> concentrations in our  
184 study and in Peng et al. (2023)<sup>26</sup> were well below the US ambient (EPA)<sup>32</sup> and occupational (OSHA)<sup>33</sup> 8-  
185 hour exposure limits (50-100 ppb), and WHO<sup>34</sup> 8-hour ambient air quality guideline levels (50 ppb). Long-  
186 term exposure to ambient O<sub>3</sub> levels of 30-40 ppb or higher is associated with elevated health risks<sup>35,36</sup>.  
187 These levels far exceed the average indoor O<sub>3</sub> concentrations (with far-UVC lamps on) measured in our  
188 study. However, the reader should note that there seems to be no clear threshold for adverse health  
189 effects<sup>37</sup>.

190 The sealed empty hotel room served as a baseline test room in our study, intended to examine  
191 worst-case conditions with low air exchange, similar to the experimental conditions in recent  
192 publications<sup>23, 26, 27</sup>. Our O<sub>3</sub> concentration levels in the sealed room were similar to Peng et al. (2023)<sup>26</sup>.

193 The modelled average fluence rates in this study were 1.7-1.8 μW/cm<sup>2</sup>, which correspond to a  
194 50-51 mJ/cm<sup>2</sup> dose during an 8-hr period (151-153 mJ/cm<sup>2</sup> during a 24-h period). These are below ACGIH  
195 recommended 8-hr exposure limits (161 mJ/cm<sup>2</sup> for eyes and 479 mJ/cm<sup>2</sup> for skin)<sup>38</sup> but higher than the  
196 ICNIRP 8-hr exposure limit<sup>39</sup> of 23 mJ/cm<sup>2</sup>.

### 197 4.2. Ultra-fine particle concentrations

198 In our study, we saw elevated UFP concentrations during far-UVC lamp usage in both rooms.  
199 However, linear regression models adjusted for outdoor O<sub>3</sub> levels indicated that when far-UVC lamps

200 were on, increasing indoor O<sub>3</sub> was associated with decreasing UFP concentrations in the standard hotel  
201 room. This suggests that increases of UFP concentrations in the standard room were mainly influenced  
202 by factors other than far-UVC generated O<sub>3</sub>. Local combustion is one potential source of UFPs<sup>40</sup> that can  
203 penetrate indoors (infiltration of outdoor particles). Although doors and windows were closed during our  
204 measurements, indoor O<sub>3</sub> concentrations responded rapidly to outdoor O<sub>3</sub> changes, suggesting that  
205 significant infiltration was occurring. Occasionally noticeable cooking odors, possibly originating from the  
206 floor below, suggested presence of significant unmeasured indoor UFP sources. Nevertheless, in-room  
207 HEPA filtration produced consistently low UFP concentrations with and without operation of far-UVC  
208 lamps.

### 209 4.3. Limitations of the study

210 As this study was carried out in a real-world setting, it has limitations that should be considered when  
211 assessing the results. One limitation is that we did not carry out local O<sub>3</sub> and UFP measurements directly  
212 outside of the hotel and in the hallways outside of the rooms. Hence, we could not define to what extent  
213 the O<sub>3</sub> or UFP concentration changes were driven by ambient conditions as opposed to far-UVC usage.  
214 Also, because the measurements of the different cases (sealed/standard room, UV on/off, etc.) were  
215 carried out in series, the data could not be paired. Also, because ambient conditions varied, comparing  
216 different cases was not ideal.

217 We chose to calculate average concentrations (O<sub>3</sub>, UFPs) based on all data in different cases (not  
218 only during steady-state conditions) because measurements in real-world settings do not often have  
219 steady-state conditions, as was clearly seen in the standard room measurements. This should be kept in  
220 mind when interpreting our results, as they might differ from laboratory measurements where it is easier  
221 to reach steady-state conditions and use them in the measurements and analysis.

222 Future studies in real-world settings could benefit from having a control room to monitor  
223 different factors simultaneously and form paired data for more accurate assessment of the effect of  
224 different factors on O<sub>3</sub> and UFP formation. It would also be beneficial to monitor O<sub>3</sub> and UFPs directly  
225 outside of the space, since fluctuations in local concentrations might affect the measured values  
226 substantially through infiltration.



## 227 5. Conclusions

228 222 nm far-UVC is a promising tool for mitigating aerosol spread of infections in high-risk settings, e.g.,  
229 hotel quarantine facilities. However, recent studies have raised health concerns related to O<sub>3</sub> production  
230 and secondary chemistry caused by the lamps. We found that 222 nm far-UVC lamps do increase O<sub>3</sub>  
231 concentrations indoors, but the average levels are lower than and notably influenced by outdoor  
232 concentrations and remain well below EPA 8-hour ambient exposure limits. Additionally, we did not find  
233 a clear relationship between UV usage and UFP concentrations. Despite study limitations, our results do  
234 not suggest a major impact of far-UVC on indoor UFP concentrations in the real-world environment that  
235 we examined. Nevertheless, we should be cognizant of and work to reduce the potential effects far-UVC  
236 has on IAQ, especially in environments with low ventilation.

## 237 Acknowledgements

238 The authors would like to thank the Balvi Foundation for funding this study. Also, support from  
239 NOAA/ARL, NIST, and MDE for trace gas measurements is gratefully acknowledged.

## 240 References

- 241 1. Adam, D. C. *et al.* Risk of within-hotel transmission of SARS-CoV-2 during on-arrival quarantine in  
242 Hong Kong: an epidemiological and phylogenomic investigation. *The Lancet Regional Health –*  
243 *Western Pacific* **0**, (2023).
- 244 2. Wei, H.-Y. *et al.* Probable Aerosol Transmission of SARS-CoV-2 through Floors and Walls of  
245 Quarantine Hotel, Taiwan, 2021. *Emerg Infect Dis* **28**, (2022).
- 246 3. Gu, H. *et al.* Probable Transmission of SARS-CoV-2 Omicron Variant in Quarantine Hotel, Hong Kong,  
247 China, November 2021. *Emerg Infect Dis* **28**, (2021).
- 248 4. Wong, S.-C. *et al.* Transmission of Omicron (B.1.1.529) - SARS-CoV-2 Variant of Concern in a  
249 designated quarantine hotel for travelers: a challenge of elimination strategy of COVID-19. *The*  
250 *Lancet Regional Health – Western Pacific* **18**, (2022).
- 251 5. Grout, L. *et al.* Failures of quarantine systems for preventing COVID-19 outbreaks in Australia and  
252 New Zealand. *Medical Journal of Australia* **215**, 320–324 (2021).
- 253 6. Leong, L. E. X. *et al.* Whole-Genome Sequencing of SARS-CoV-2 from Quarantine Hotel Outbreak.  
254 *Emerg Infect Dis* **27**, 2219–2221 (2021).

- 255 7. Hart, D. STERILIZATION OF THE AIR IN THE OPERATING ROOM BY SPECIAL BACTERICIDAL RADIANT  
256 ENERGY: Results of Its Use in Extrapleural Thoracoplasties. *Journal of Thoracic Surgery* **6**, 45–81  
257 (1936).
- 258 8. Wells, W. F. *et al.* The environmental control of epidemic contagion I. An epidemiologic study of  
259 radiant disinfection of air in day schools. *Am J Hyg* **35**, 97–121 (1942).
- 260 9. Riley, R. L. and Permutt, S. Room air disinfection by ultraviolet irradiation of upper air. Air mixing and  
261 germicidal effectiveness. *Arch Environ Health* **22**, 208–219 (1971).
- 262 10. Bergman, R. *et al.* Air Disinfection with Germicidal Ultraviolet: For this Pandemic and the Next.  
263 *Photochem Photobiol* **97**, 464–465 (2021).
- 264 11. Reed, N. G. The history of ultraviolet germicidal irradiation for air disinfection. *Public Health Rep.*  
265 **125** (1), 15-27 (2010). ISSN 0033-3549.
- 266 12. Wells, W. F. and Wells, M. W. Measurement of Sanitary Ventilation. *Am J Public Health Nations*  
267 *Health* **28** (3), 343-350 (1938). doi: 10.2105/ajph.28.3.343
- 268 13. Riley, R. L. and Permutt, S. Room air disinfection by ultraviolet irradiation of upper air. Air mixing and  
269 germicidal effectiveness. *Arch Environ Health* **22** (2), 208-219 (1971). doi:  
270 10.1080/00039896.1971.10665834
- 271 14. Riley, R. L. and Nardell, E. A. Clearing the air. The theory and application of ultraviolet air  
272 disinfection. *Am Rev Respir Dis.* **139** (5), 1286-1294 (1989). doi: 10.1164/ajrccm/139.5.1286
- 273 15. Pfeifer, G.P. *et al.* Mutations induced by ultraviolet light. *Mutat Res.* **571**(1-2), 19–31 (2005). doi:  
274 10.1016/j.mrfmmm.2004.06.057.
- 275 16. Delic, N. C. *et al.* Damaging Effects of Ultraviolet Radiation on the Cornea. *Photochem Photobiol.*  
276 **93**(4), 920–929 (2017). doi: 10.1111/php.12686.
- 277 17. Eadie, E. *et al.* Extreme Exposure to Filtered Far-UVC: A Case Study†. *Photochem Photobiol* **97**, 527–  
278 531 (2021).
- 279 18. Fukui, T. *et al.* Exploratory clinical trial on the safety and bactericidal effect of 222-nm ultraviolet C  
280 irradiation in healthy humans. *PLOS ONE* **15**, e0235948 (2020).
- 281 19. Eadie, E. *et al.* Far-UVC (222 nm) efficiently inactivates an airborne pathogen in a room-sized  
282 chamber. *Sci Rep* **12**, 4373 (2022).
- 283 20. Ma, B. *et al.* UV Inactivation of SARS-CoV-2 across the UVC Spectrum: KrCl\* Excimer, Mercury-Vapor,  
284 and Light-Emitting-Diode (LED) Sources. *Appl Environ Microbiol* **87**, e0153221 (2021).
- 285 21. Ma, B. *et al.* UV Inactivation of Common Pathogens and Surrogates Under 222 nm Irradiation from  
286 KrCl\* Excimer Lamps. *Photochemistry and Photobiology* **99**(3), 975-982, (2023).

- 287 22. Welch, D. *et al.* Inactivation Rates for Airborne Human Coronavirus by Low Doses of 222 nm Far-UVC  
288 Radiation. *Viruses* **14**, 684 (2022).
- 289 23. Barber, V. *et al.* Indoor Air Quality Implications of Germicidal 222 nm Light. Preprint at  
290 <https://doi.org/10.26434/chemrxiv-2023-ft1l8> (2023).
- 291 24. Ma, B. *et al.* Reflection of UVC wavelengths from common materials during surface UV disinfection:  
292 Assessment of human UV exposure and ozone generation. *Science of The Total Environment*, (2023)  
293 doi:10.1016/j.scitotenv.2023.161848.
- 294 25. Peng, Z. *et al.* Model Evaluation of Secondary Chemistry due to Disinfection of Indoor Air with  
295 Germicidal Ultraviolet Lamps. *Environ. Sci. Technol. Lett.* (2022) doi:10.1021/acs.estlett.2c00599.
- 296 26. Peng, Z. *et al.* Significant Production of Ozone from Germicidal UV Lights at 222 nm. *Environ. Sci.*  
297 *Technol. Lett.* (2023), **10**, 668-674.
- 298 27. Link, M. F. *et al.* Ozone generation from a Germicidal Ultraviolet lamp with Peak Emission at 222 nm.  
299 *Environ. Sci. Technol. Lett.* (2023), **10**, 675-679.
- 300 28. Centers for Disease Control, National Center for Immunization and Respiratory Diseases (NCIRD),  
301 Division of Viral Diseases. Community, Work, and School: Ventilation in Buildings. *Centers for*  
302 *Disease Control and Prevention* [https://www.cdc.gov/coronavirus/2019-](https://www.cdc.gov/coronavirus/2019-ncov/community/ventilation.html)  
303 [ncov/community/ventilation.html](https://www.cdc.gov/coronavirus/2019-ncov/community/ventilation.html) (2023).
- 304 29. Batterman, S. Review and Extension of CO<sub>2</sub>-Based Methods to Determine Ventilation Rates with  
305 Application to School Classrooms. *Int J Environ Res Public Health* **14**, 145 (2017).
- 306 30. Zhu, S. *et al.* Ventilation and laboratory confirmed acute respiratory infection (ARI) rates in college  
307 residence halls in College Park, Maryland. *Environ Int* **137**, 105537 (2020).
- 308 31. Nazaroff, W. W. and Weschler C. J. Indoor Ozone: Concentrations and influencing factors. *Indoor Air*  
309 **32 (1)**, e12942.
- 310 32. Environment Protection Agency (EPA) National Ambient Air Quality Standards (80 FR 65292).  
311 Environmental Protection Agency (2015).
- 312 33. OSHA Occupational Safety and Health Standards 1910, Toxic and Hazardous Substances 1910  
313 subpart Z, Air contaminants 1910.1000. Occupational Safety and Health Administration, Department  
314 of Labor. Washington, DC, USA.
- 315 34. WHO global air quality guidelines. Particulate matter (PM<sub>2.5</sub> and PM<sub>10</sub>), ozone, nitrogen dioxide,  
316 sulfur dioxide and carbon monoxide. Geneva: World Health Organization; 2021. Licence: CC BY-NC-  
317 SA 3.0 IGO.
- 318 35. Jerret, M. *et al.* Long-Term Ozone Exposure and Mortality. *N Engl J Med* **360**, 1085-1095 (2009).

- 319 36. Lim, C. C. *et al.* Long-Term Exposure to Ozone and Cause-Specific Mortality Risk in the United States.  
320 Am. J. Respir. Crit. Care Med **200 (8)**, 1022-1031 (2019).
- 321 37. Bell, M. L. *et al.* The exposure-response curve for ozone and risk of mortality and the adequacy of  
322 current ozone regulations. Environ Health Perspect. **114**, 532-536 (2006).
- 323 38. American Conference of Governmental Industrial Hygienists (ACGIH) Threshold Limit Values and  
324 Biological Exposure Indices. ACGIH; Cincinnati: 2022.
- 325 39. International Commission on Non-Ionizing Radiation Protection (ICNIRP). Guidelines on limits of  
326 exposure to ultraviolet radiation of wavelengths between 180 nm and 400 nm (incoherent optical  
327 radiation). *Health Physics*, **87 (2)**, 171-186 (2004).
- 328 40. Morawska, L. *et al.* Ambient nano and ultrafine particles from motor vehicle emissions:  
329 characteristics, ambient processing and implications on human exposure. Atmos. Environ. **42**, 8113–  
330 8138 (2008).
- 331
- 332

333 Figures

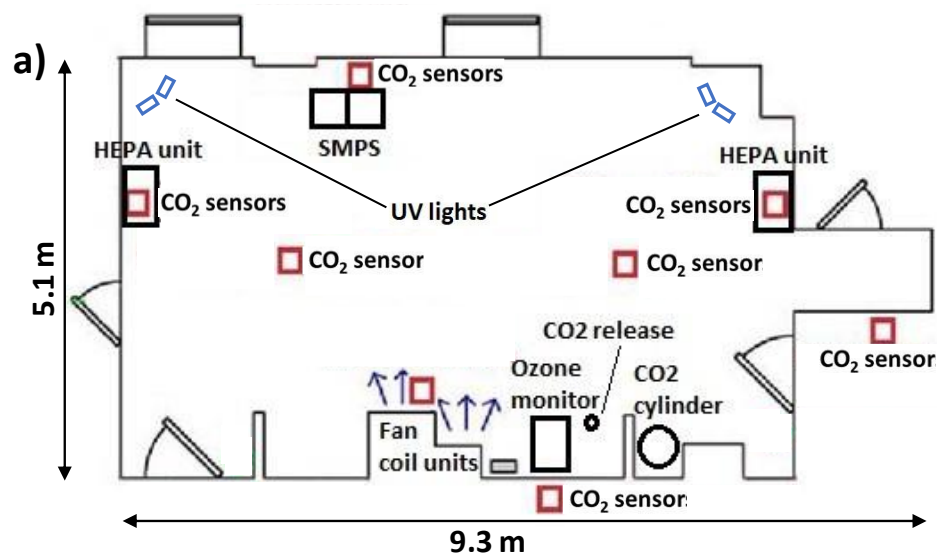

b)

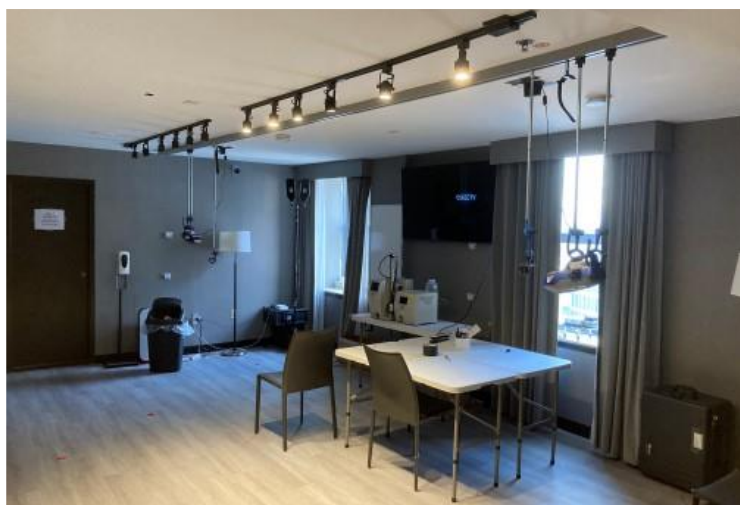

334

335 Figure 1. Sealed unfurnished hotel room. a) Floor plan (room height: 2.4 m) and position of far-UVC  
336 lamps and sampling equipment. b) Photograph showing SMPS between windows, vinyl flooring, far-UVC  
337 lamps and minimal furnishings. Floor plan not in scale.

338

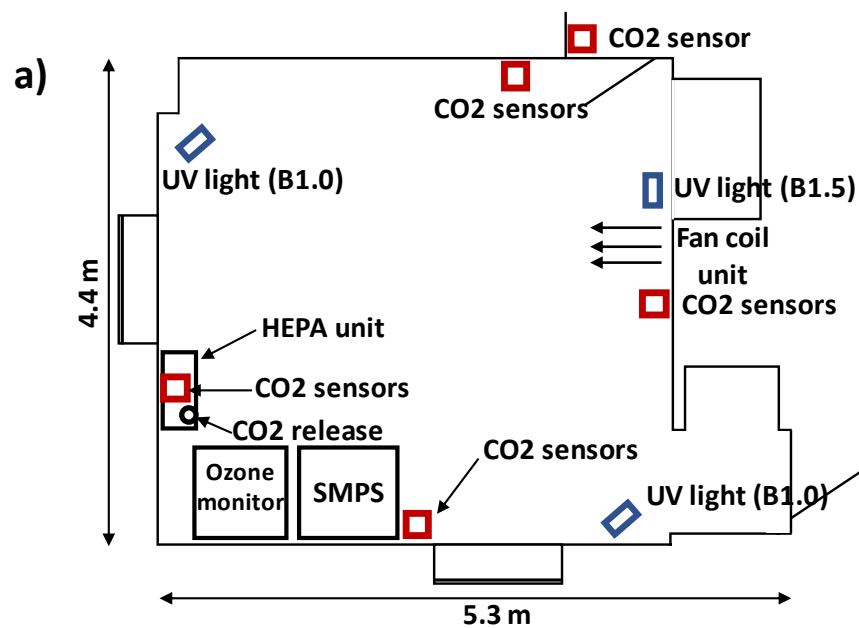

b)

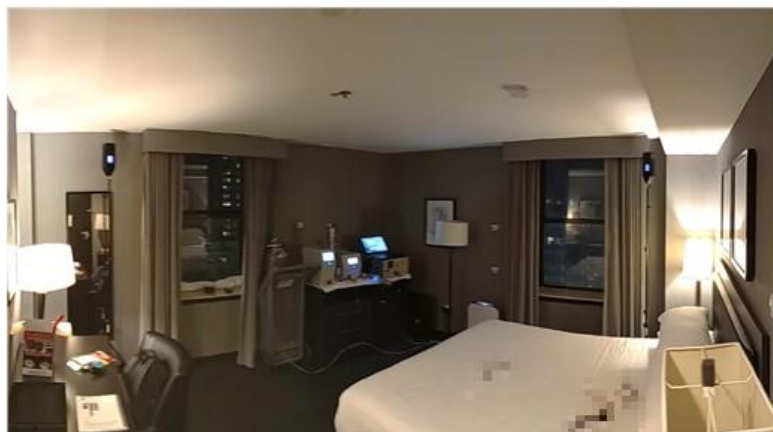

339

340 Figure 2. Standard hotel room. a) Floor plan (room height: 2.4 m) and position of far-UVC lamps and  
341 sampling equipment. b) Photograph showing far-UVC lamps, sampling equipment, and standard  
342 furnishing. Floor plan not in scale.

343

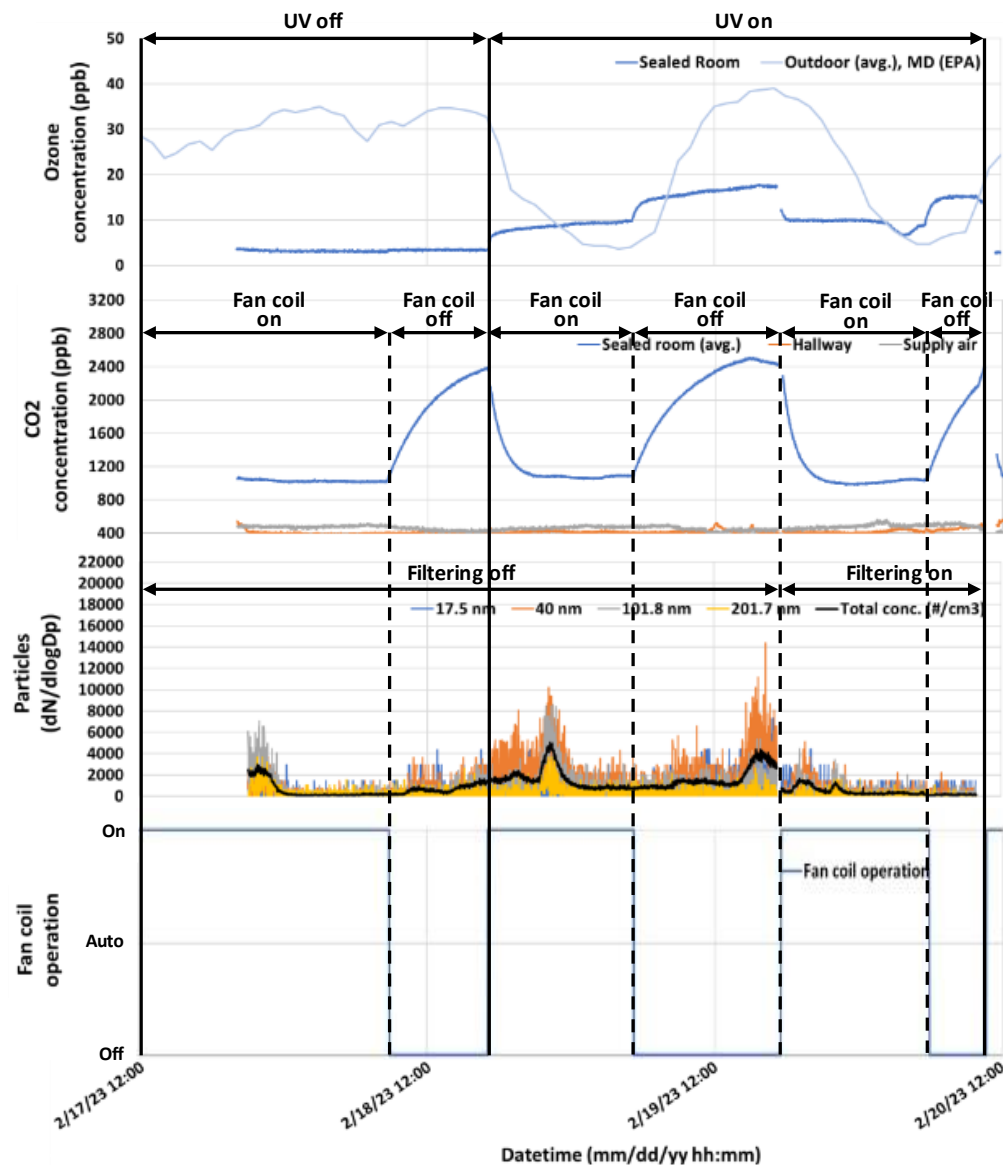

344

345 Figure 3. Sealed room O<sub>3</sub>, CO<sub>2</sub> and ultra-fine particle measurements plotted against time. Periods with  
346 far-UVC lamps (on/off), in-room HEPA filtering (on/off) and fan coil unit states (on/off/auto) are shown.  
347 Fan coil unit had 2 states: off (0.1 ACH) and on (0.5 ACH). During the filtering periods the fan coil unit had  
348 a MERV 13 filter and the HEPA filter unit had a HEPA filter but they had no filter during other times. The  
349 outdoor O<sub>3</sub> levels are an average of three Maryland sites (Essex, Glen Burnie, Padonia) in the EPA  
350 Ambient Air Monitoring Network. The CO<sub>2</sub> concentration in the sealed room is an average of all sensors  
351 in the room.

352

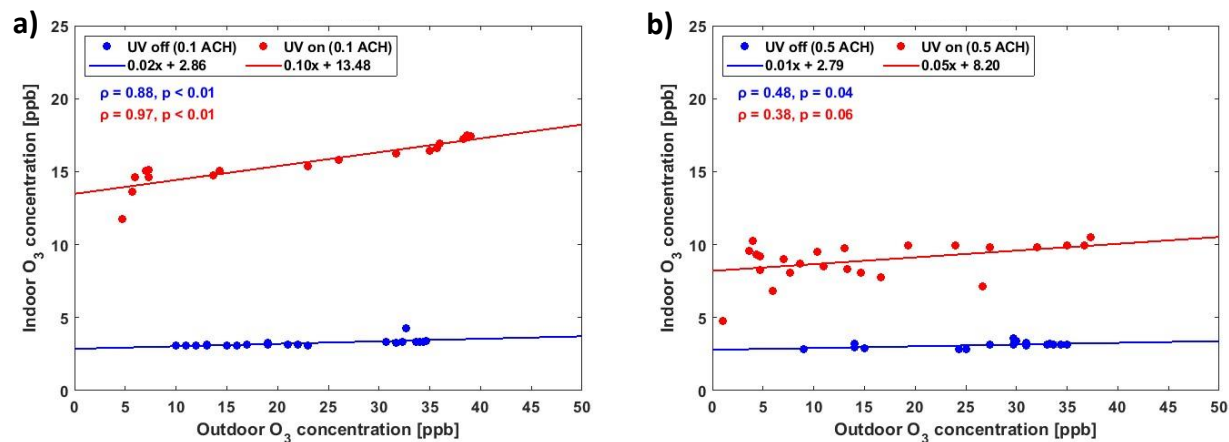

353

354 Figure 4. Sealed room indoor-outdoor concentration correlations with and without UV with (a) 0.1 ACH  
355 (fan coil off) and (b) 0.5 ACH (fan coil on) ventilation rates. The outdoor O<sub>3</sub> levels are an average of three  
356 Maryland sites (Essex, Glen Burnie, Padonia) in the EPA Ambient Air Monitoring Network.  $\rho$  is the  
357 Spearman's rank correlation coefficient.

358



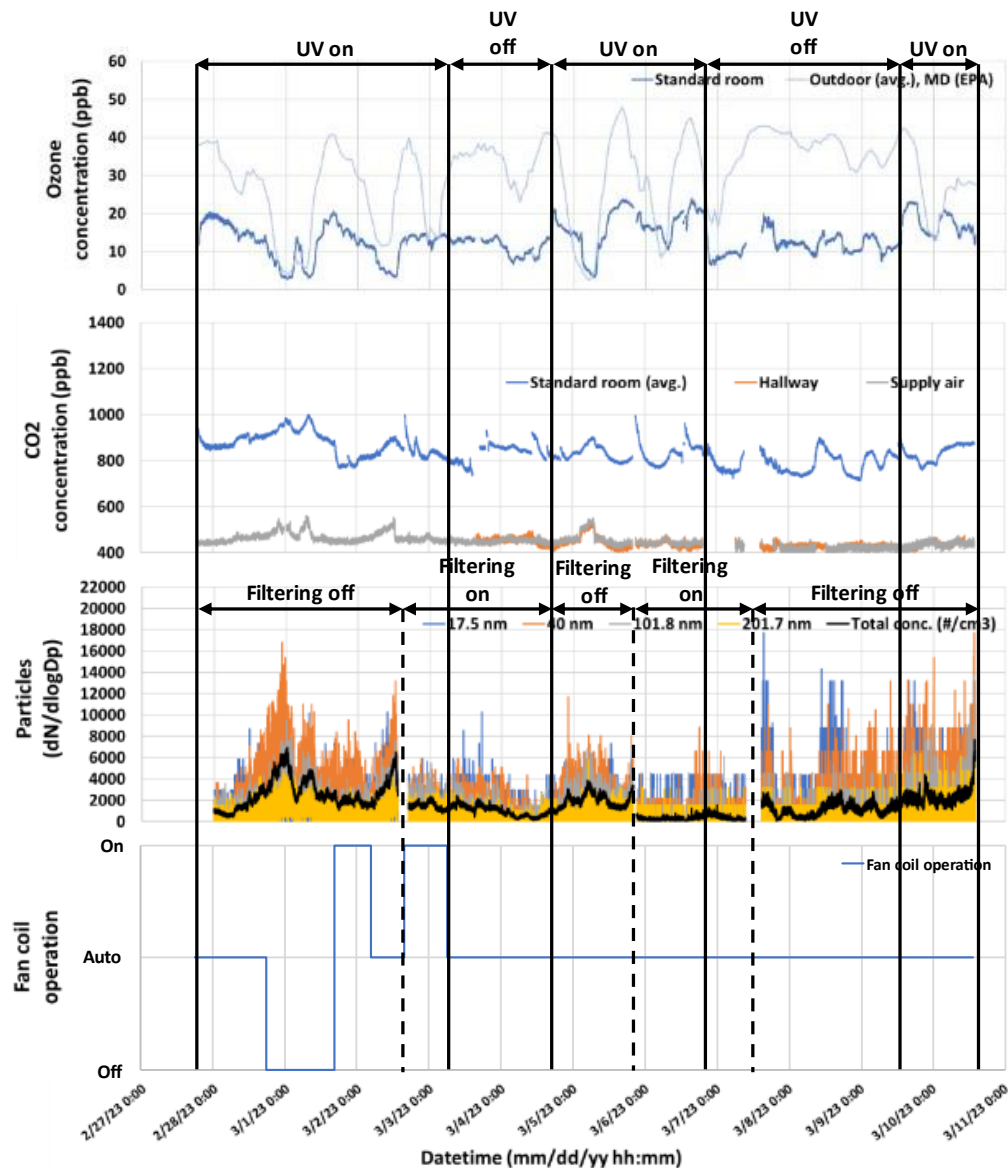

359

360 Figure 5. Standard hotel room O<sub>3</sub>, CO<sub>2</sub>, and UFP measurements from February 27 through March 11,  
361 2023. Periods with far-UVC lamps and in-room HEPA filtering on and off and fan coil unit states (on, off  
362 and auto) are shown. During the auto state, the fan coil unit ran intermittently as controlled by a  
363 thermostat and motion sensor. During the filtering periods the fan coil unit had a MERV 13 filter and the  
364 HEPA filter unit had a HEPA filter but they had no filter during other times.

365

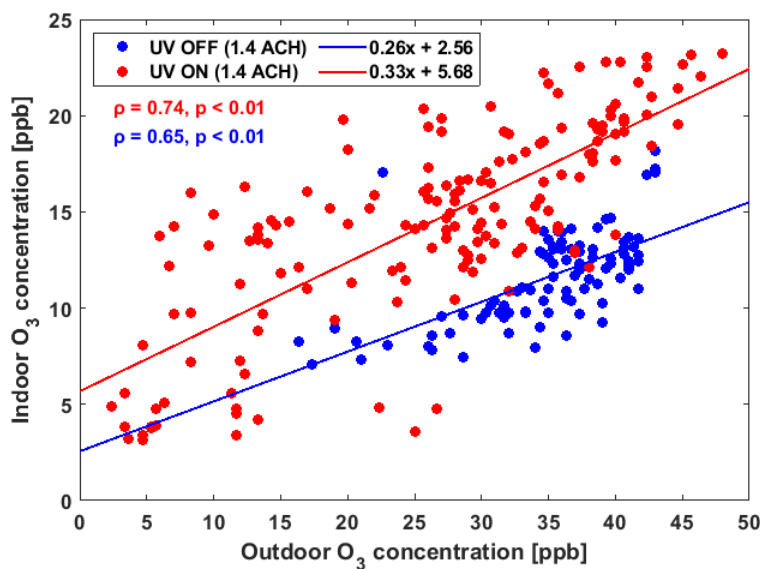

366

367 Figure 6. Indoor versus outdoor O<sub>3</sub> concentrations for the standard hotel room when far-UVC lamps were  
368 on and off (with an average air exchange rate of 1.4 ACH). The outdoor O<sub>3</sub> levels are an average of three  
369 Maryland sites (Essex, Glen Burnie, Padonia) in the EPA Ambient Air Monitoring Network.  $\rho$  is the  
370 Spearman's rank correlation coefficient.

371

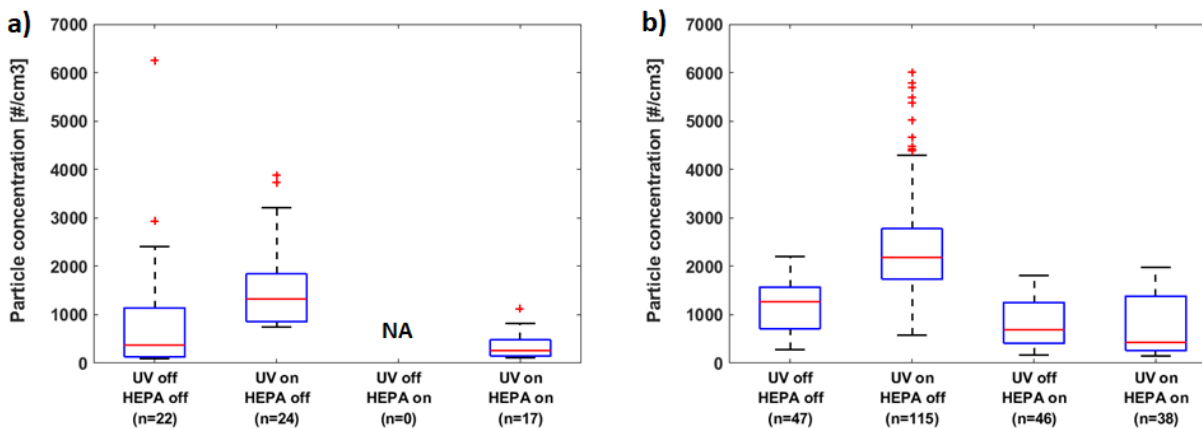

372

373 Figure 7. Ultra-fine particle concentrations (17.5 to 289 nm) with and without use of 222 nm far-UVC  
374 lamps and HEPA filters a) in the sealed unfurnished room (no data from HEPA on UV off) and b) in the  
375 standard room. Boxplots show medians (redline inside the boxes), 25th and 75th percentiles (top and  
376 bottom of the boxes), most extreme data not considered outliers (whiskers) and outliers (red crosses) of  
377 1-hr data. n represents the number of 1-hr data points included in each boxplot. HEPA filter units  
378 delivered 232 L/s (9.1 ACH) in the sealed room and 116 L/s (7.1 ACH) in the standard room. Simultaneous  
379 background measurements to account for indoor and outdoor sources were not collected.

380