

Activation, exhaustion and senescence markers

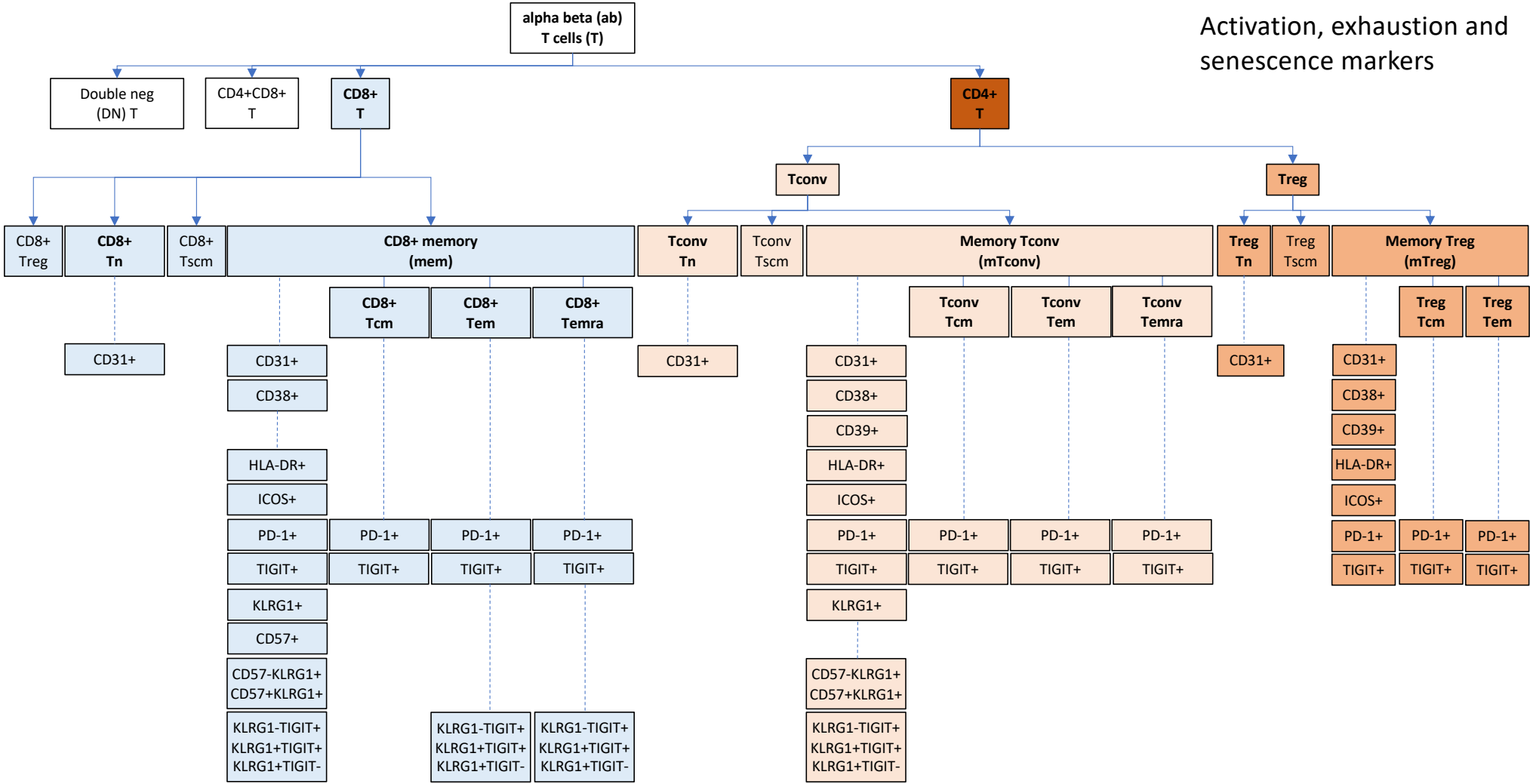

Helper T cells and Helper T cell-like Tregs

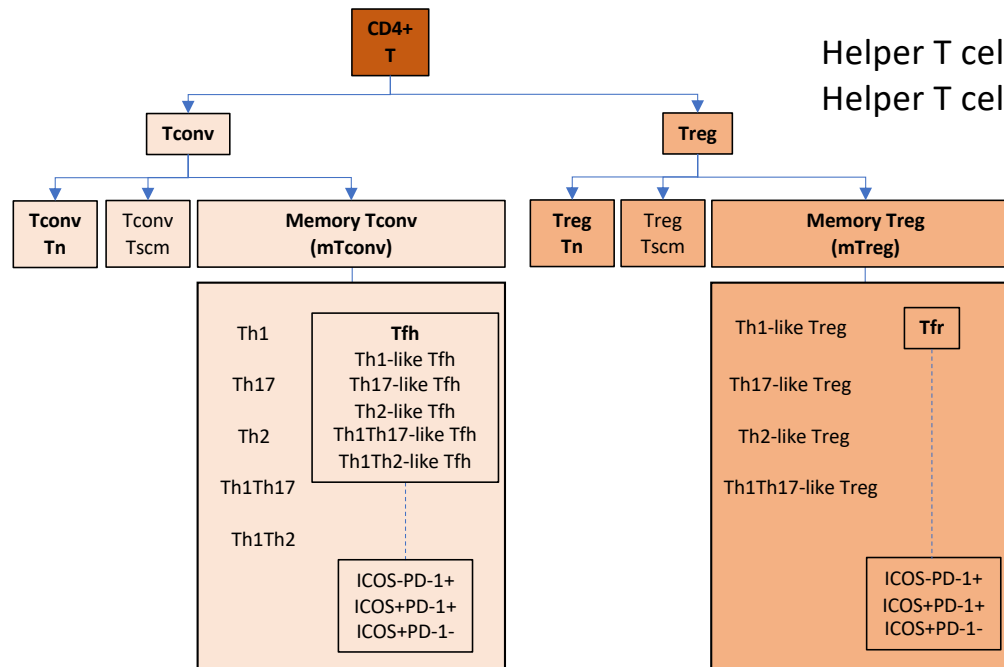

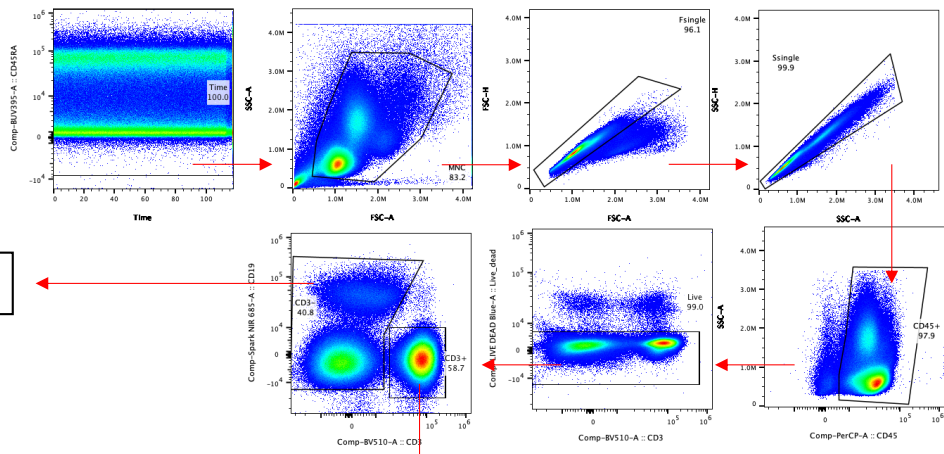

See Non-CD3 slide

gd T cells

NKT

CD8+ T

CD4+ T

CD8+ MAIT

CD4-CD8-
MAIT

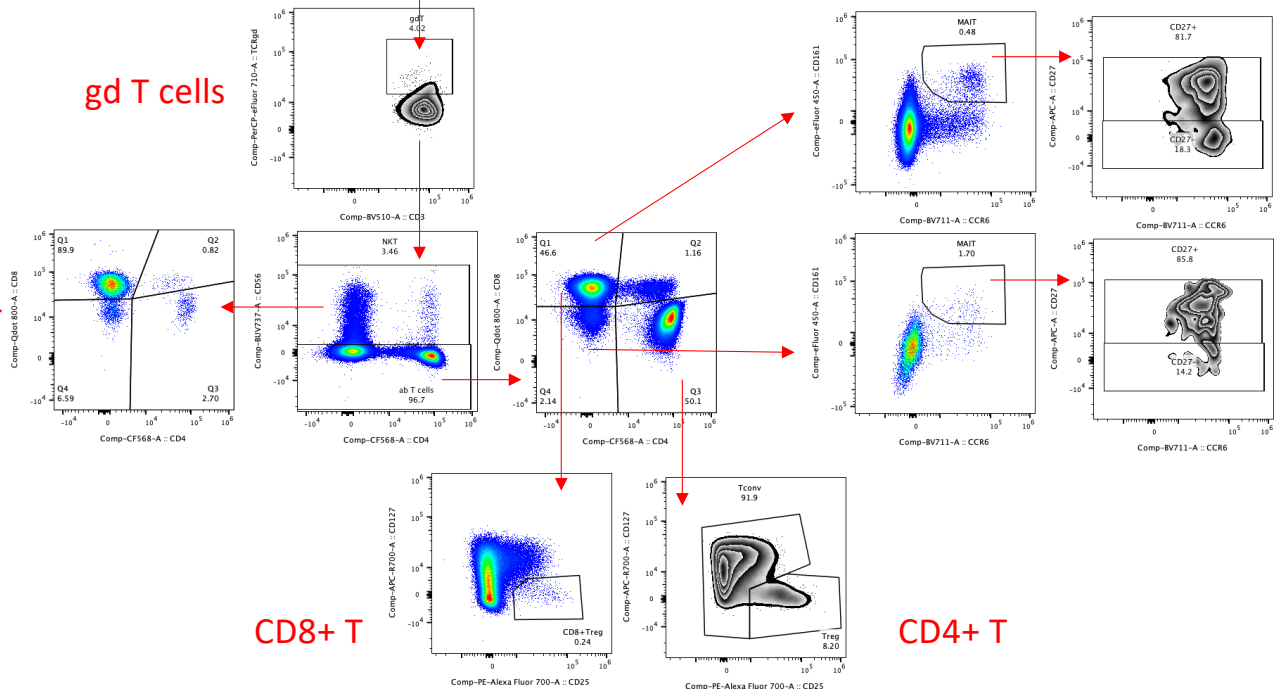

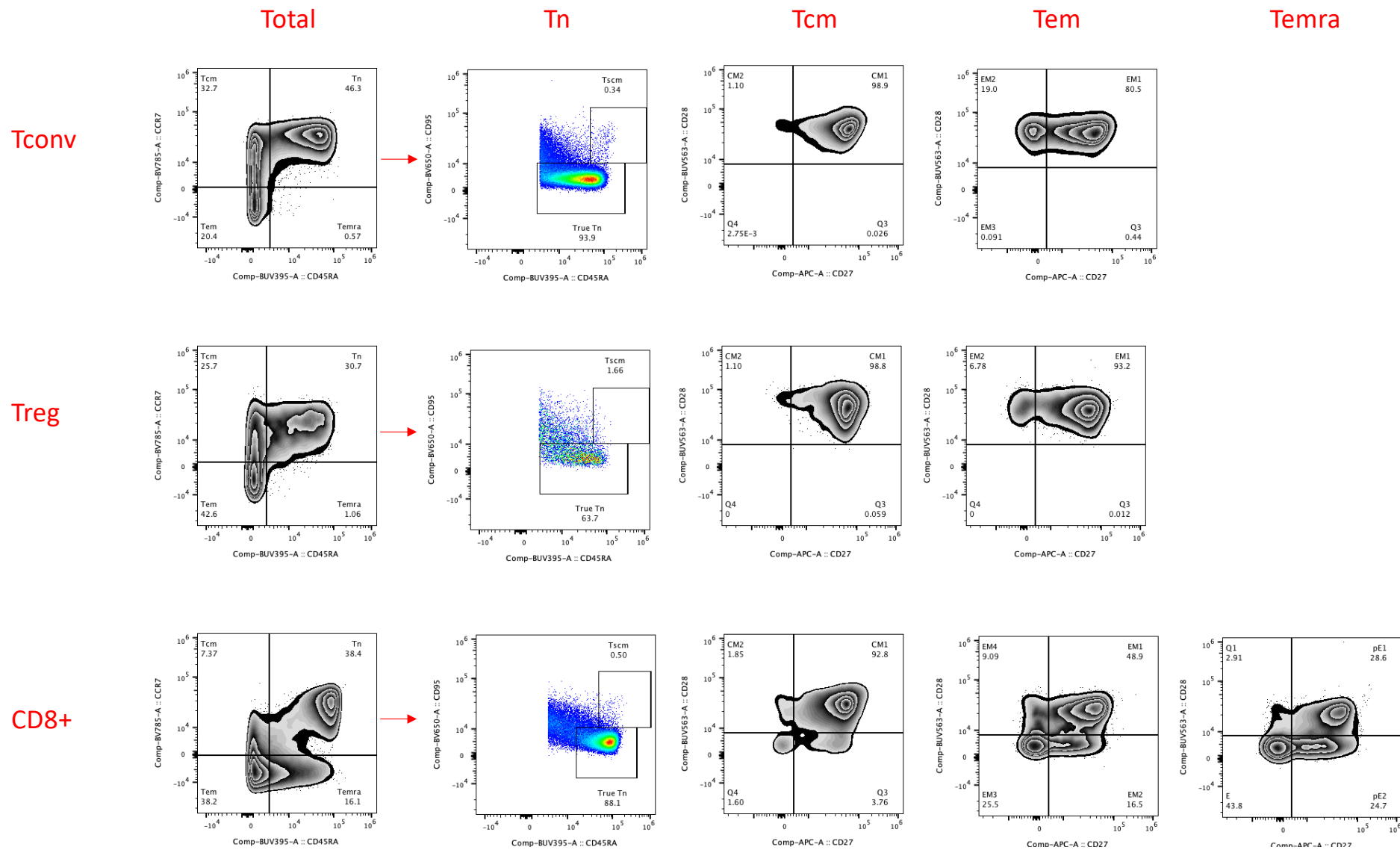

CD31+ Tn

CD31+ total mem

CD38+ total mem

CD39+ total mem

HLA-DR+ total mem

ICOS+ total mem

Tconv

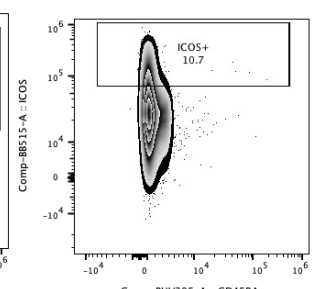
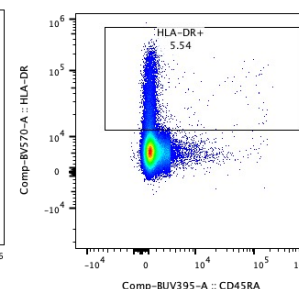
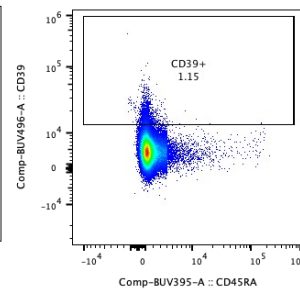
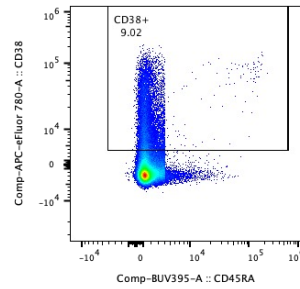
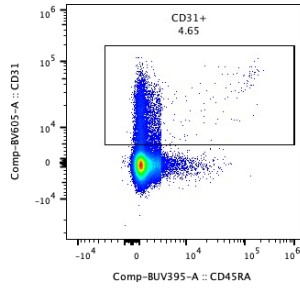
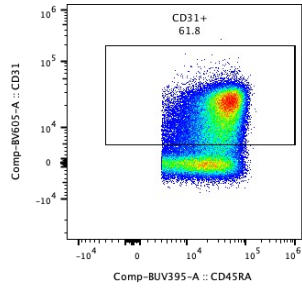

Treg

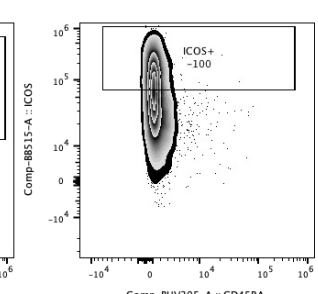
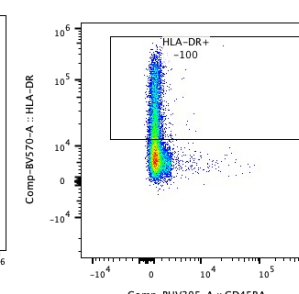
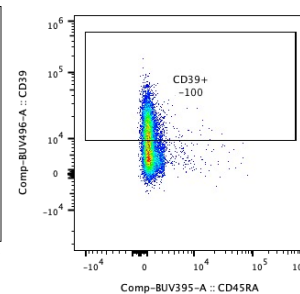
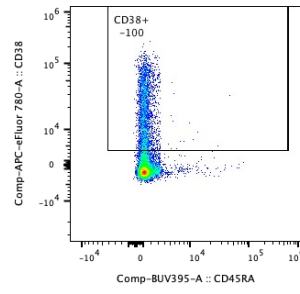
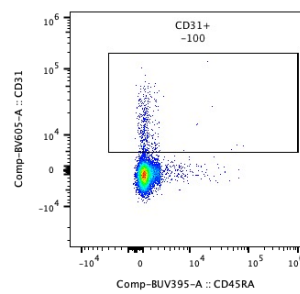
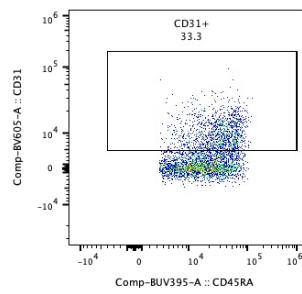

CD8+

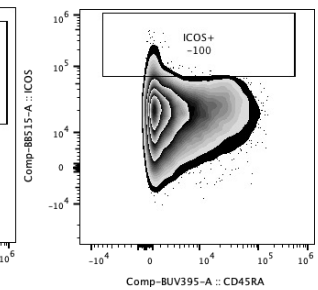
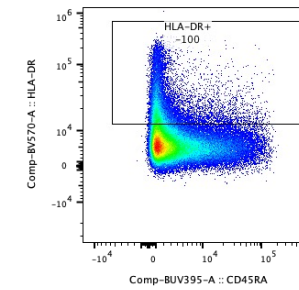
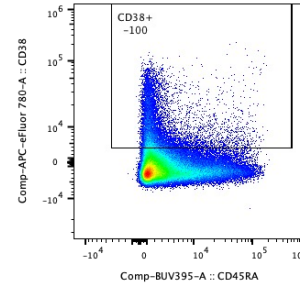
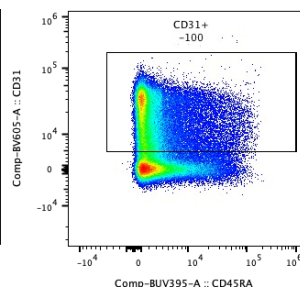
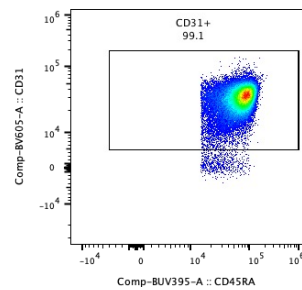

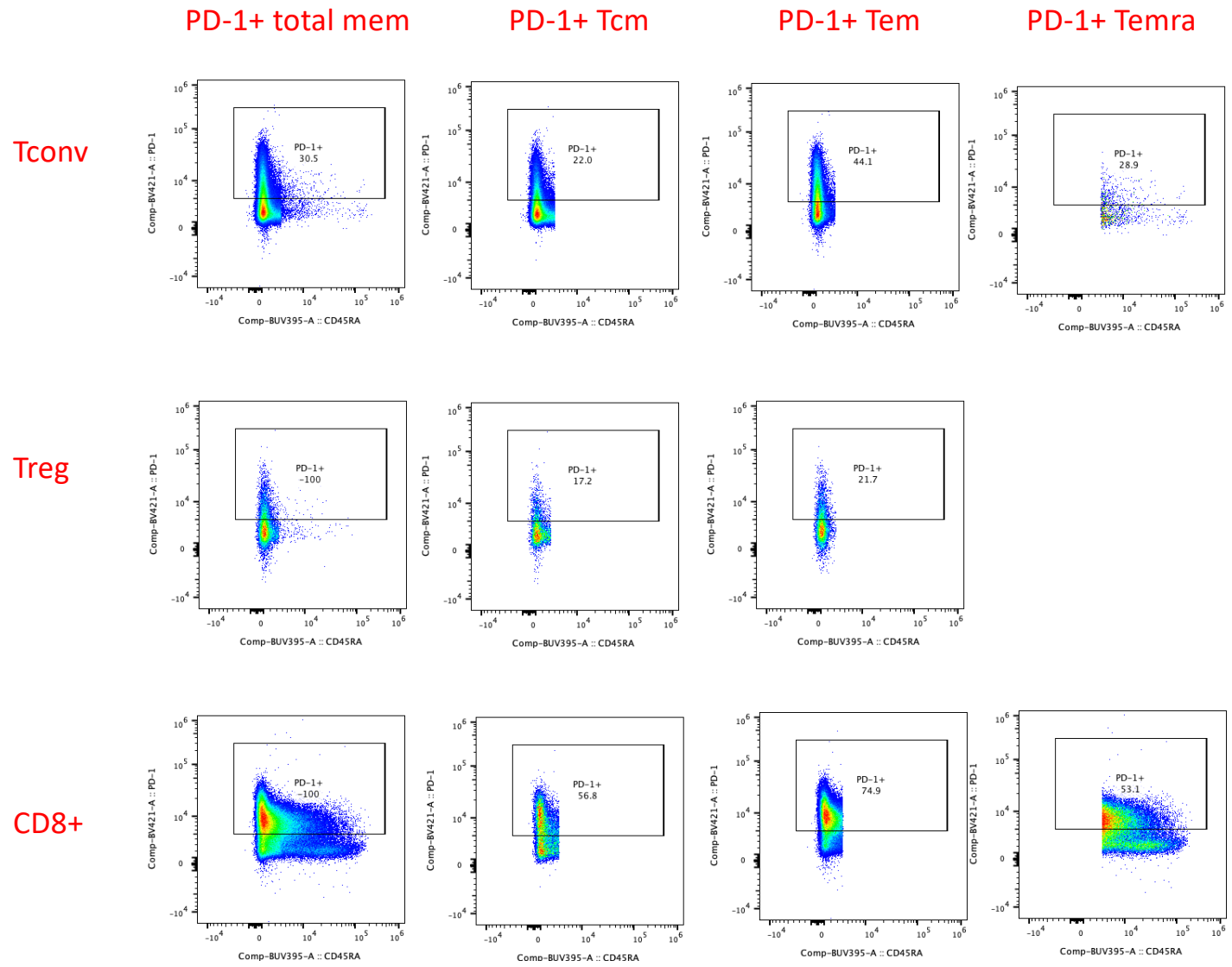

Tconv

TIGIT+ total mem

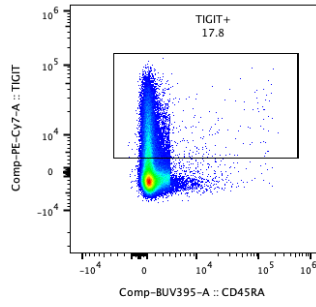

TIGIT+ Tcm

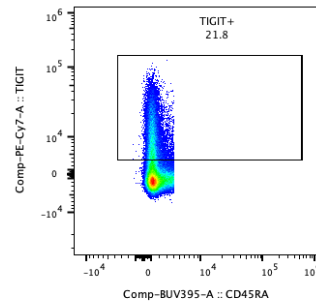

TIGIT+ Tem

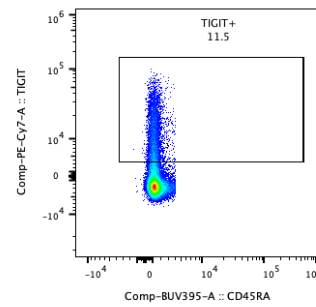

TIGIT+ Temra

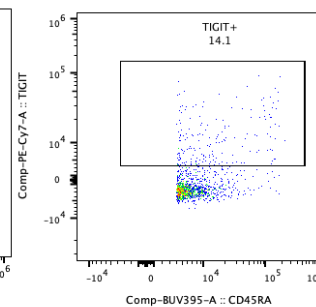

Treg

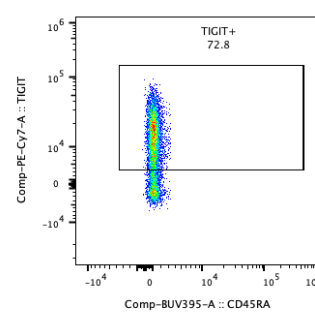
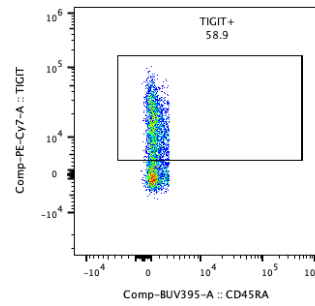
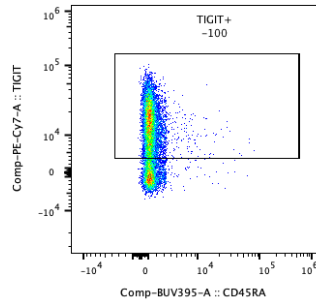

CD8+

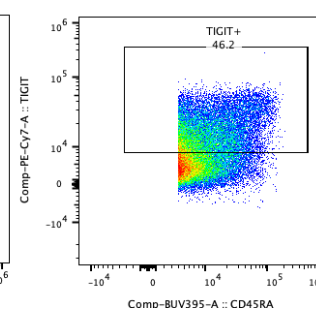
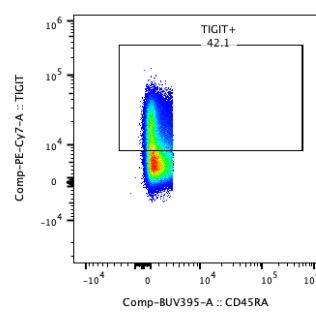
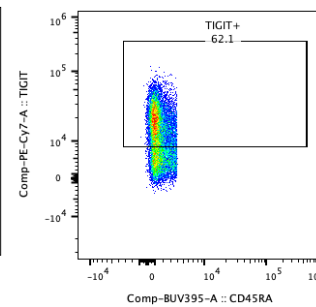
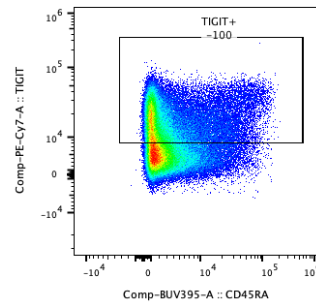

KLRG1 & CD57
total mem

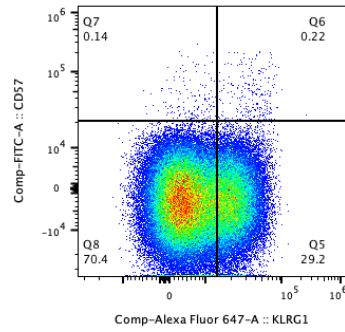

KLRG1 & TIGIT
total mem

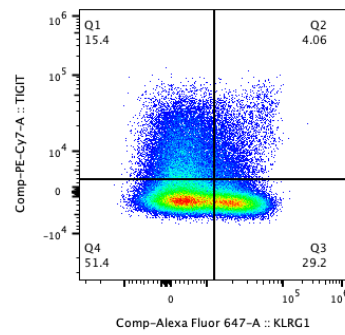

KLRG1 & TIGIT
Tem

KLRG1 & TIGIT
Temra

Tconv

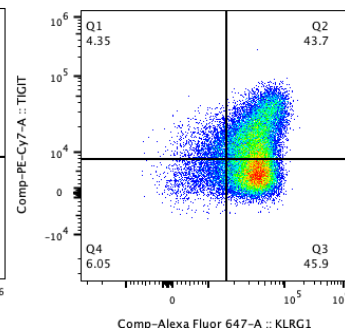
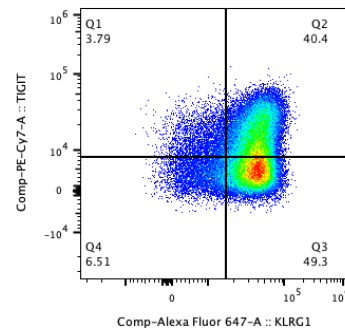
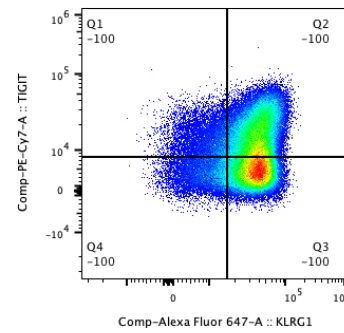
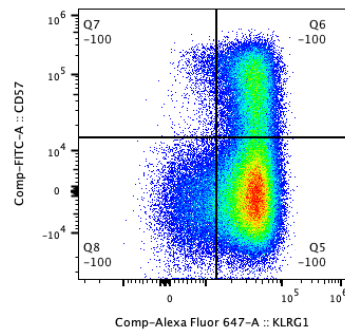

CD8+

Memory Tconv (mTconv)

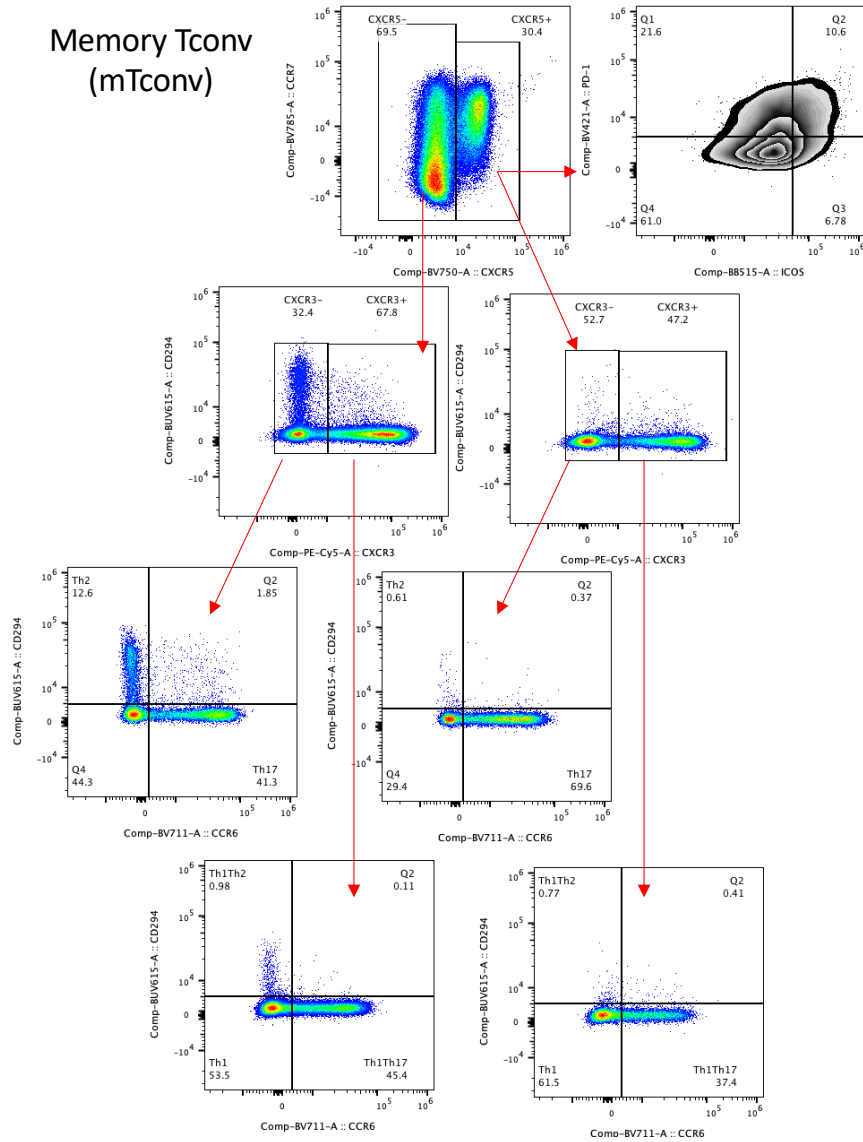

Memory Treg (mTreg)

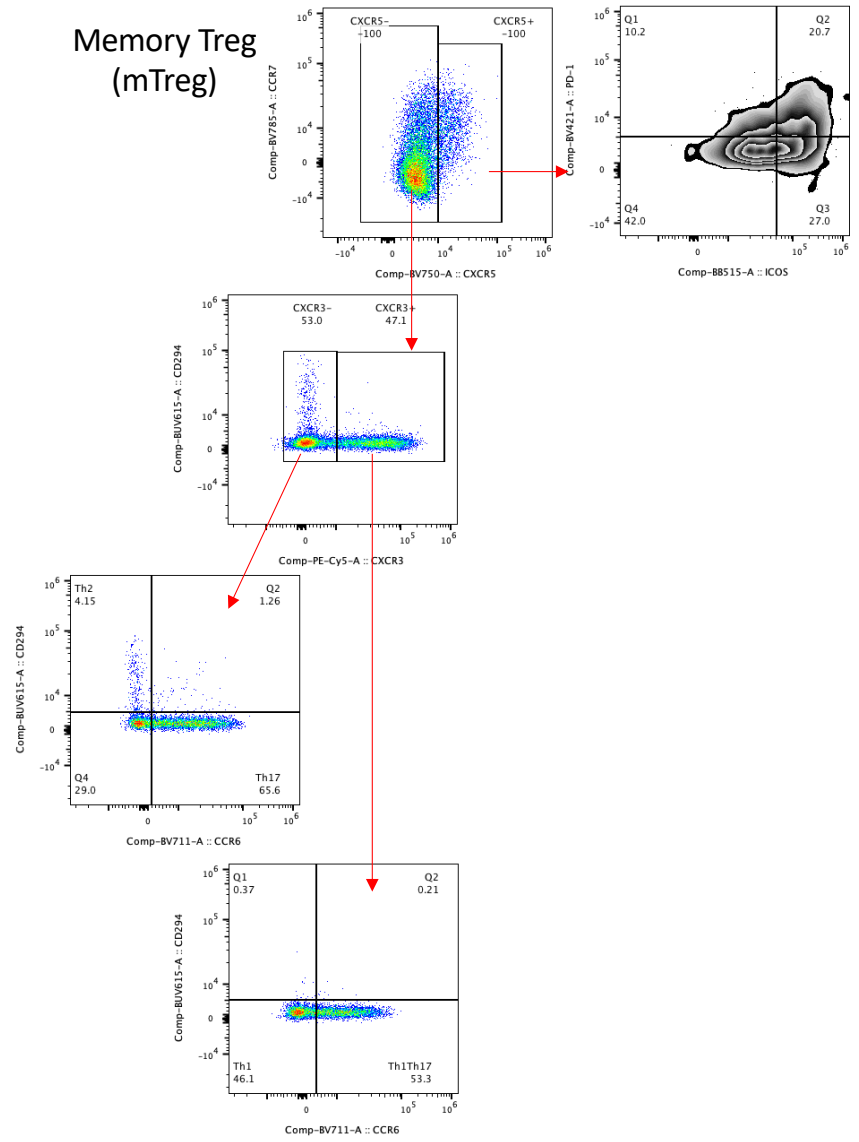

Non-CD3 slide

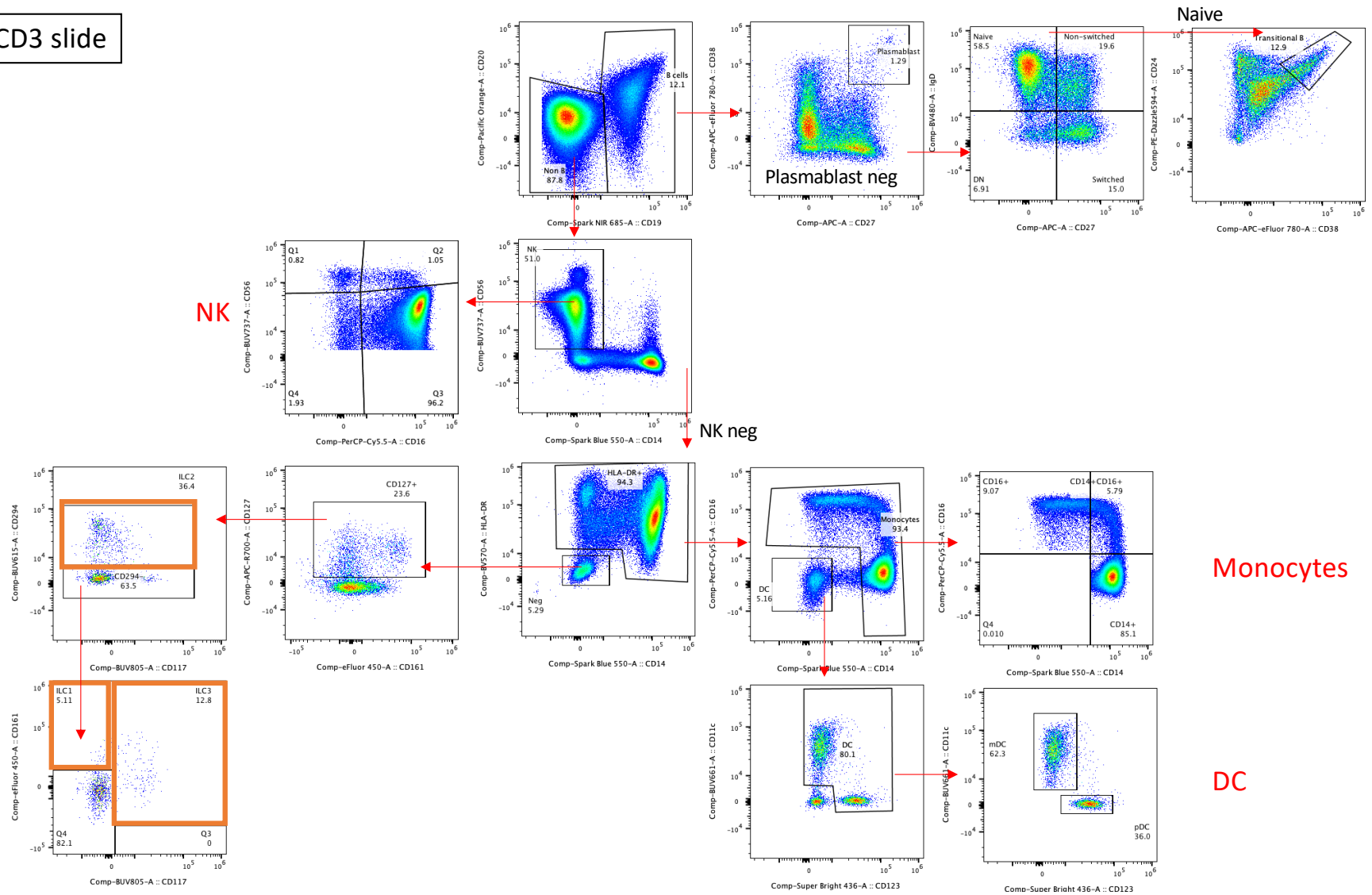

B cells

Monocytes

DC

NK

NK neg

ILC