

1 **Estimating the distribution of COVID-19-susceptible, -recovered, and**
2 **-vaccinated individuals in Germany up to April 2022**

3 Benjamin F. Maier,^{1,*} Annika H. Rose,¹ Angelique Burdinski,¹ Pascal Klamser,¹
4 Hannelore Neuhauser,² Ole Wichmann,³ Lars Schaade,¹ Lothar H. Wieler,¹ and Dirk Brockmann¹

5 ¹*Robert Koch Institute, Nordufer 20, D-13353 Berlin, Germany*

6 ²*Robert Koch Institute, General-Pape-Straße 62-66, D-12101 Berlin, Germany*

7 ³*Robert Koch Institute, Seestraße 10, D-13353 Berlin, Germany*

8 (Dated: April 19, 2022)

Abstract

After having affected the population for two years, the COVID-19 pandemic has reached a phase where a considerable number of people in Germany have been either infected with a SARS-CoV-2 variant, vaccinated, or both. Yet the full extent to which the population has been in contact with either virus or vaccine remains elusive, particularly on a regional level, because (a) infection counts suffer from under-reporting, and (b) the overlap between the vaccinated and recovered subpopulations is unknown. Since previous infection, vaccination, or especially a combination of both reduce the risk of severe disease, a high share of individuals with SARS-CoV-2 immunity lowers the probability of severe outbreaks that could potentially overburden the public health system once again, given that emerging variants do not escape this reduction in susceptibility. Here, we estimate the share of immunologically naïve individuals by age group for each of the 16 German federal states by integrating an infectious disease model based on weekly incidences of SARS-CoV-2 infections in the national surveillance system and vaccine uptake, as well as assumptions regarding under-ascertainment. We estimate a median share of 7.0% of individuals in the German population have neither been in contact with vaccine nor any variant as of March 31, 2022 (quartile range [3.6%–9.8%]). For the adult population at higher risk of severe disease, this figure is reduced to 3.5% [1.3%–5.5%] for ages 18–59 and 4.3% [2.7%–5.8%] for ages 60 and above. However, estimates vary between German states mostly due to heterogeneous vaccine uptake. Excluding Omicron infections from the analysis, 16.1% [14.0%–17.8%] of the population in Germany, across all ages, are estimated to be immunologically naïve, highlighting the large impact the Omicron wave had until the beginning of spring in 2022.

9 I. INTRODUCTION

10 The COVID-19 pandemic caused by the rapid global dissemination of the SARS-CoV-2 virus
11 and its respective variants has led to a large number of infections worldwide [1]. In Germany,
12 around 21.4 million infections have been reported as of the end of March 2022. Moreover, a
13 large part of the population has received a primary vaccination series with one of the available
14 COVID-19 vaccines (mRNA-vaccine by BioNTech or Moderna, or a vector-based vaccine by
15 AstraZeneca or Janssen) [2]. The national COVID-19 vaccination campaign began at the end of
16 2020 by targeting older adults, residents of nursing homes, and healthcare workers, then shifting

* maierb@rki.de

17 focus to younger adults [3]. In August 2021, a recommendation to vaccinate adolescents aged 12-
18 17 was issued [4] and since December 2021, children aged 5-11 years are recommended to receive
19 a vaccination if underlying medical conditions put them at increased risk for severe disease [5]. In
20 Germany, recovered individuals are advised not to receive a COVID-19 vaccination until 6 months
21 [6], or 3 months [7] have passed after infection. At the time of analysis, booster vaccinations have
22 been recommended for all persons aged 11 years and older [8, 9]. A central factor that will
23 determine how the pandemic progresses in Germany in the near future is the number of people
24 still immunologically naïve to infection, i.e. that have neither been in contact with the virus or
25 any of its variants nor a vaccine against them. In Germany, several serological studies have been
26 conducted [10, 11], but none that extend into the time of the Omicron waves, particularly with
27 respect to children. Therefore, we choose a mathematical modeling approach here to estimate the
28 number of immunologically naïve individuals in order to facilitate informed decisions with regard
29 to the upcoming pandemic situation in the fall of 2022.

30 To estimate the number of people that have been in contact with either virus or vaccine, one
31 might simply summate the number of vaccinations and the number of reported infections. How-
32 ever, doing so ignores the fact that (a) a considerable number of vaccinated people have suffered
33 from additional breakthrough infections (taking into account both asymptomatic and symptomatic
34 infections herein) [12], (b) a substantial number of previously infected people have chosen to be
35 vaccinated in accordance with national recommendations [13–15], (c) some individuals have suf-
36 fered from multiple infections [16], and (d) the exact extent of the total number of infections as
37 compared to the reported number of infections is unknown because (i) asymptomatic infections
38 are less likely to be identified and reported in the national surveillance system and (ii) under-
39 ascertainment varies regionally [17, 18]. In order to estimate the overlap between the vaccinated
40 and recovered subpopulations, one may assume that the probability of any recovered individual
41 to be vaccinated is proportional to the probability of any individual to be vaccinated. However,
42 this largely ignores (i) the heterogeneous dynamics of the spreading disease and vaccination cam-
43 paigns, and (ii) that vaccinated individuals are less likely to suffer from an infection than unvac-
44 cinated individuals [19]. Here, we introduce modeling approaches that are devised to meet the
45 aforementioned conditions and use them to estimate the distribution of immunologically naïve,
46 (in the infectious disease modeling context called “fully susceptible” hereafter), recovered, and
47 vaccinated individuals in Germany, taking into account regional and age differences. We find that
48 although the percentage of the adult population in Germany that remains fully susceptible is ex-

49 pected to be in the single digits, the share of unaffected children may be considerably larger. Due
50 to heterogeneities in vaccine uptake across German states, these values may differ by region. Our
51 analysis cannot answer questions regarding the quality of achieved immunity against infection
52 or disease, because we consider neither waning of immunity nor the emergence of variants with
53 immune evasive properties, which is difficult to predict [20].

54 II. METHODS

55 We partition the population into $n_G = 16$ regions corresponding to the German states and $n_A = 5$
56 age groups corresponding to ages “00-04” (infants), “05-11” (children), “12-17” (adolescents),
57 “18-59” (adults), “60+” (elderly), chosen in accordance with the population structure of publicly
58 available vaccination data [2], i.e. into 80 subpopulations. To obtain nation-wide counts of individ-
59 uals in age groups, we sum the respective results over all regions, to obtain counts of individuals
60 for all ages, we sum over all age groups. To obtain an age-independent, nation-wide result, we
61 sum over all ages and all regions.

62 As we are, first and foremost, interested in estimating the proportion of individuals $S_\infty \equiv S(t =$
63 $t_{\max})$ that can be considered to be fully susceptible towards infection with any SARS-CoV-2 variant
64 per region and age group, we report a simplified model here that captures the main ideas and gives
65 the same results for $S(t)$ as the full model which is reported in the Appendix (see App. A 1).

66 We consider the population of size N (an age group in a region) to be composed of suscepti-
67 ble (S), infected/recovered (I), infected/recovered but eligible for reinfection or vaccination (Y),
68 vaccinated (V), and boosted (B) individuals, assuming that the population count is constant over
69 two years such that $N = S + I + Y + V + B = \text{const}$.

The central problem of estimating S_∞ is to determine the overlap between recovered and vac-
cinated subpopulations. Given that the cumulative number of unvaccinated infected R_∞ and the
number of cumulative vaccinated individuals V_∞ is known, one may naively assume that the proba-
bility that an infected person that was initially unvaccinated is vaccinated later on is proportional to
the probability that any person in the population is vaccinated, which is given as $p = V_\infty/N$. Then,
the cohort size of unvaccinated and not yet infected individuals is $S_\infty = N - (1 - V_\infty/N)R_\infty - V_\infty$.
However, this largely ignores the time course of infections and vaccinations, with incidence and
daily vaccinations peaking at different time points, with a large number of infections occurring
after the peak in vaccinations. Hence, one may assume instead that when a person becomes vacci-

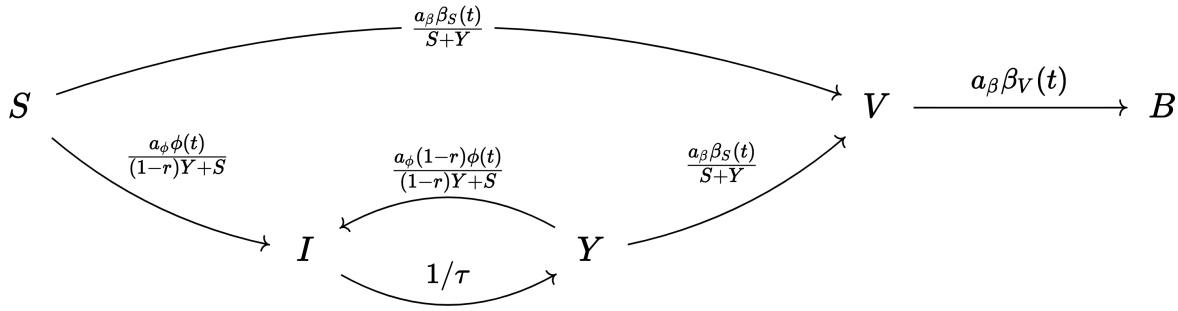

FIG. 1. Simplified model schema. On each day, $a_\beta \beta_S(t) \Delta t$ unvaccinated people become vaccinated, with under-ascertainment ratio a_β and $\Delta t = 1d$. The probability that a newly vaccinated person has been infected before is proportional to the respective size of the subpopulation of recovered people that are eligible for vaccination Y . Furthermore, on each day, $a_\phi \phi(t) \Delta t$ unvaccinated people become infected, with under-ascertainment ratio a_ϕ . The probability that a newly infected person has been infected before is proportional to the respective size of the subpopulation of recovered people that are eligible for reinfection $(1-r)Y$, where $1-r$ is the relative reinfection probability or “recovered immunity”. Recovered individuals are expected to reach eligibility for reinfection/vaccination after an average duration of τ . (Note that in the full model breakthrough and reinfections of vaccinated individuals are possible (see App. A 1).)

nated at time t , the probability that this person was already infected is proportional to the number of infected/recovered individuals at time t that are eligible for vaccination as $p = Y/(S+Y)$. With incidence rates of $a_\phi \phi(t)$ (new unvaccinated cases per day) and vaccination rates of $a_\beta \beta_S(t)$ (new vaccinations per day) obtained from data, we assume that the count of individuals in the respective states evolves dynamically as

$$\partial_t S = -a_\phi \phi(t) \frac{S}{(1-r)Y+S} - a_\beta \beta_S(t) \frac{S}{Y+S} \quad (1)$$

$$\partial_t I = a_\phi \phi(t) - \frac{I}{\tau} \quad (2)$$

$$\partial_t Y = \frac{I}{\tau} - a_\beta \beta_S(t) \frac{Y}{Y+S} - a_\phi \phi(t) \frac{(1-r)Y}{(1-r)Y+S} \quad (3)$$

$$\partial_t V = a_\beta \beta_S(t) - a_\beta \beta_V(t) \quad (4)$$

$$\partial_t B = a_\beta \beta_V(t). \quad (5)$$

70 The last two equations are shown here for completeness, but note that the number of vaccinated
 71 and boosted individuals can simply be obtained from data, without integrating the dynamic equa-

72 tions, as their integrals can be evaluated analytically and are equal to the cumulative number of
73 respective vaccinations. Above, a_ϕ and a_β are under-ascertainment ratios that account for infec-
74 tions and vaccinations that have not been reported. The time scale τ is equal to the average time
75 after which an infected/recovered individual becomes eligible for reinfection or vaccination and
76 $1 - r$ is the relative probability that an unvaccinated recovered person is reinfected as compared to
77 a fully susceptible individual.

78 For our analysis, we draw 1,000 pairs of a_ϕ and a_β from shifted Gamma distributions with
79 means $\langle a_\phi \rangle = 2$, $\langle a_\beta \rangle = 1.03$, and standard deviations $\text{Std}[a_\phi] = 1$, $\text{Std}[a_\beta] = 0.02$ that are bounded
80 below by $\min(a_\bullet) = 1$. Note that this distribution yields a median under-ascertainment ratio of
81 $Q_2[a_\phi] = 1.7$, which is in line with results informed by seroprevalence data for Germany in 2020
82 [18]. Furthermore, with a 97.5th percentile of 4.7, the distribution is broad enough to account
83 for occasional high under-ascertainment ratios that have been observed locally [10, 17, 18]. For
84 infants, ascertainment is expected to be lower than for other age groups [21], which is why we dou-
85 ble under-ascertainment ratios for this age group. We did not assume a higher under-ascertainment
86 ratio for children older than 4 years, because regular screening via rapid antigen tests is mandatory
87 in schools across the country [22]. We choose an eligibility time of $\tau = 90\text{d}$, which is approxi-
88 mately of the same order as the time for antibody concentrations to decay after an infection [23].
89 While it falls in the lower bound of officially recommended time for recovered individuals to wait
90 before getting vaccinated, surveys indicate that people might not strictly follow the official recom-
91 mendation but get vaccinated earlier. Further, people with asymptomatic courses might have no
92 knowledge about their infection, likely leading to a bias towards shorter times between infection
93 and vaccination in those cases. The influence of lower and higher values of τ is investigated in a
94 sensitivity analysis. The “recovered immunity” parameter r quantifies the relative efficacy against
95 reinfection. For the Alpha variant, this efficacy was observed to be lower than the vaccine efficacy
96 against infection by mRNA- or vector-vaccines [24], but of similar order as the vaccine efficacy
97 against infection with Delta, taking on values of $r \approx 0.65$ for both. As Omicron is considered to
98 be a variant with partial immune escape, we set a lower default value of $r = 1/2$ for all variants,
99 testing $r = 0$ (no protection against reinfection) and $r = 1$ (full immunity) in sensitivity analyses.

100 The daily vaccination rates $\beta_\bullet(t)$ are obtained from data [2] and averaged over calendar weeks
101 to remove weekly modulations. Likewise, infection rates of unvaccinated individuals $\phi(t)$ are
102 obtained from reported data in the German reporting system SurvStat [25], which is available in
103 aggregated form upon request. While the vaccination status is unknown for a substantial number

104 of infections, we assume that for every day, the proportion of cases with unknown vaccination
105 status that are, in fact, unvaccinated, is equal to the proportion of unvaccinated cases over the last
106 seven days for which the vaccination status is known. This imputation method is performed for
107 age- and region-stratified data.

108 For analyses disregarding infections with Omicron, we obtained the nation-wide and age-
109 independent share of randomly sequenced samples in Germany [26] that the software framework
110 “scorpio” identified as “Omicron” or “Probable Omicron” on a per-calendar-week basis by date
111 of extraction (“Entnahmedatum”) as $\sigma(t)$, assuming $\sigma(t) = 0$ for dates previous to Aug 1, 2021
112 and $\sigma(t) = 1$ for dates that exceed the last available date in the data. Then, all incidence rates
113 were scaled as $\phi_{S,\text{pre-Omicron}}(t) = \phi_S(t)[1 - \sigma(t)]$. Note that vaccination rates are unaffected by
114 this procedure.

115 Population sizes stratified by age and state were requested from destatis [27].

116 Eqs. (1)-(5) are integrated using Euler’s method with $\Delta t = 1\text{d}$ until the last day of available
117 incidence/vaccination data. For dates where data is unavailable, we assume the respective rates
118 are equal to zero.

119 III. RESULTS

120 We find an estimated nationwide median share of fully susceptible individuals of 7.0% (quartile
121 range [3.6%–9.8%]). This result is, however, biased towards higher values due to a larger share of
122 yet unaffected infants (44.6% [27.5%–56.8%]), children (22.5% [7.9%–34.3%]), and adolescents
123 (5.0% [1.0%–10.1%]). For age groups that are associated with a higher probability of severe
124 disease [28], we find a lower relative frequency of 3.5% [1.3%–5.5%] (adults), and 4.3% [2.7%–
125 5.8%] (elderly).

126 These values are achieved largely due to the (at the time of analysis still ongoing) Omicron
127 wave. Ignoring infections with the Omicron variant, the nationwide age-independent share of
128 fully susceptibles increases to 16.1% [14.0%–17.8%], i.e. Omicron infections are expected to
129 have caused a reduction in fully susceptible individuals on the order of 10 percentage points at the
130 time of writing, though this number differs by age group. While the change in relative frequency
131 of fully susceptibles in the “adult” and “elderly” age groups was only about a few percentage
132 points (median decreases from 9.2% to 3.5% and from 6.6% to 4.3%, respectively), the three
133 youngest age groups were affected much more strongly, with median values of fully susceptible

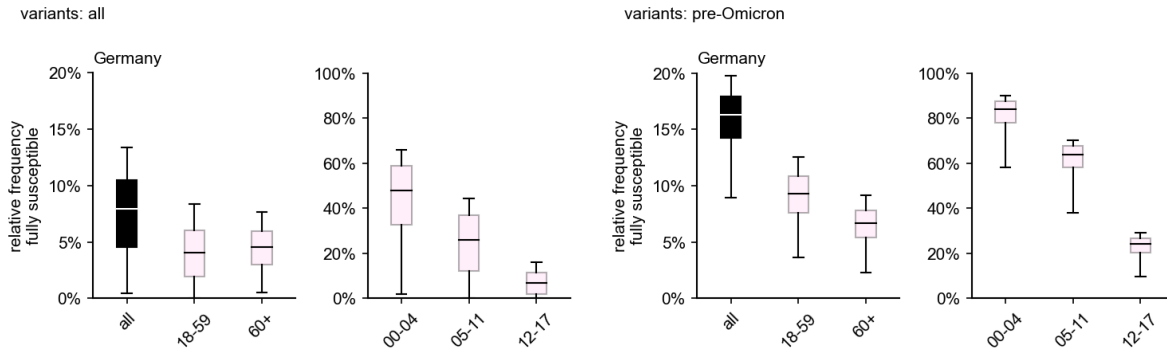

FIG. 2. Estimated nationwide relative frequency of fully susceptible individuals by age group, considering vaccinations and infections that took place up to and including March 2022. Boxes represent the area between quartiles Q_1 , Q_3 and whiskers the 2.5th and 97.5th percentiles, respectively, the median is shown as a horizontal line. (Left) Considering infections with any variant. (Right) Considering infections with any variant other than Omicron and its sublineages.

134 individuals dropping from 83.3% to 44.6%, from 63.5% to 22.5%, and from 23.8% to 5.0% with
135 increasing age (cf. Fig. 2). If all variants are considered, the median share of fully susceptible
136 “adults” and “elderly” barely differ (absolute difference of 0.8% points), likely due to a larger
137 fraction of Omicron-recovered “adults” (Fig. 2).

138 Although the relative frequency of fully susceptibles varies between federal state, certain com-
139 monalities are still shared. In all states, the frequency of fully susceptible individuals decreases
140 with age, with a strong dependence on age for children. For ages 12-17, the frequency reaches
141 values on the same order as those of the age groups “adults” and “elderly” (Fig. 3). Apart from the
142 fact that adult and elderly age groups achieve relative frequencies of fully susceptible individuals
143 below 10%, there are no other common patterns that stand out across all states regarding these
144 age groups. In general, these age groups show overlapping quartile intervals, with the exception
145 of Hamburg and Bremen, where “adults” show a comparatively lower relative frequency (Fig. 3).
146 In fact, in Bremen virtually no one aged 18 and above is expected to not have been in contact with
147 either virus or vaccine, according to the estimations.

148 In general, the above observations hold for the pre-Omicron analysis as well, except for the fact
149 that, in the majority of states, the number of adults that were still unaffected decreased dramatically
150 during the Omicron wave due to the large number of infections caused by the variant (comparing
151 Figs. 4, 3). When excluding Omicron infections, the relative frequency of fully susceptibles differs

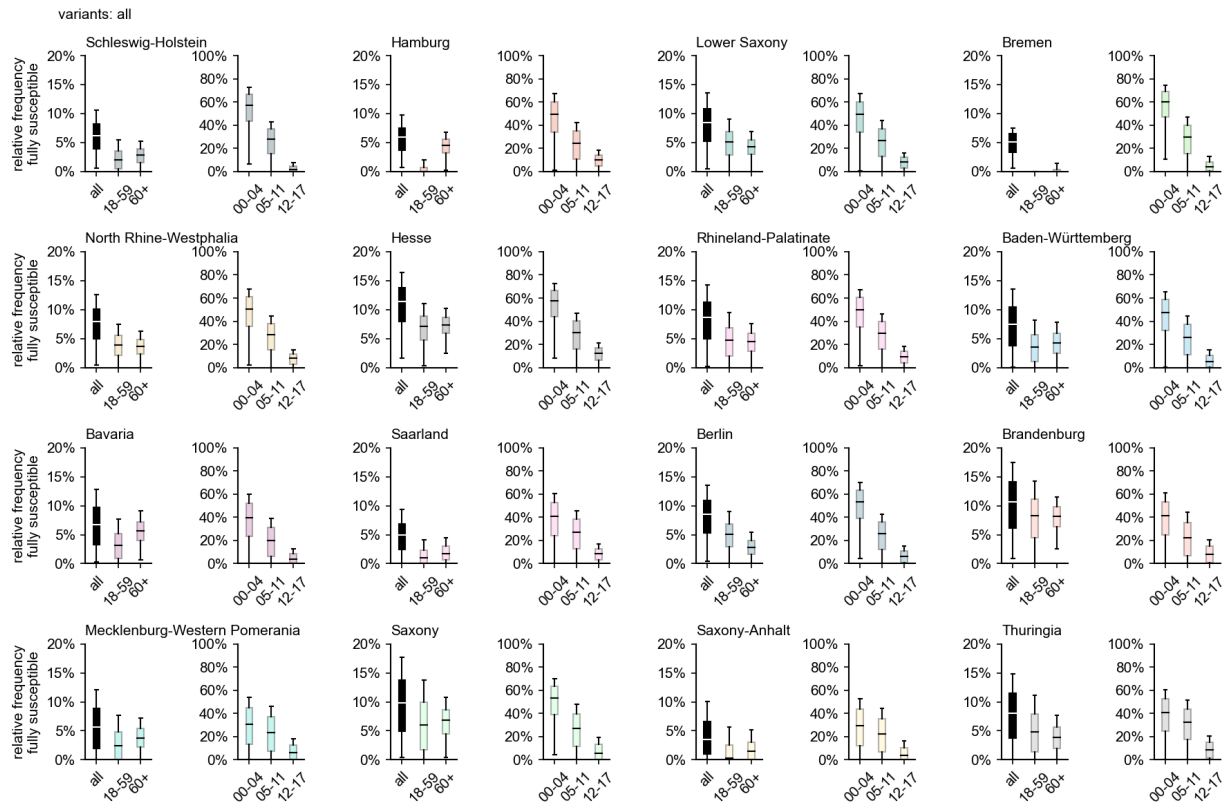

FIG. 3. Estimated relative frequency of fully susceptible individuals by age group and region considering infections with any variant and vaccinations up to and including the Omicron wave (as of March 31, 2022).

152 across states on the order of $\sim 10\%$, with Saxony and Bremen as the states with largest (20.3%)
 153 and smallest (10.0%) respective median values of fully susceptible individuals (Fig. 4). Including
 154 infections with Omicron, the median range between states is reduced to a difference of 6.0% points
 155 (median of 10.7% in Hesse and 4.7% in Bremen).

156 Our results are robust against changes in assumed eligibility time τ and recovered immunity
 157 r , varying by a few percentage points in the nationwide average for all ages. For the most at-risk
 158 age groups, i.e. adults and the elderly, these results vary even less, indicating that the influence of
 159 these parameters decreases with age (see Sec. B and Fig. 7).

160 Regarding the detailed distribution of individuals by vaccination/infection status, we find that
 161 the largest single compartment of the model population is the group of people that has received a
 162 booster vaccination and has never been in contact with the virus (see Sec. B and Fig. 6), with un-
 163 vaccinated recovered individuals comprising the second largest group. When first excluding, then including
 164 Omicron infections, both the number of non-infected vaccinated and non-infected booster vacci-

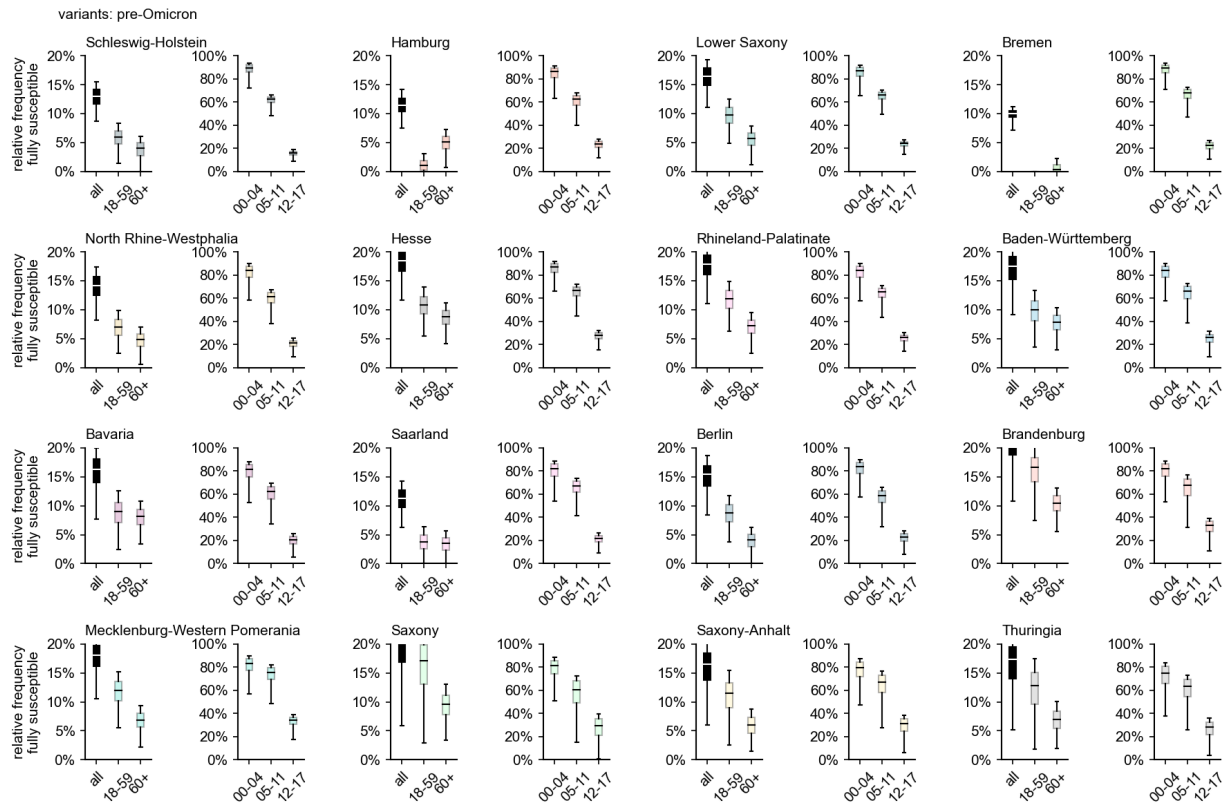

FIG. 4. Estimated relative frequency of fully susceptible individuals by age group and region, disregarding infections with Omicron and its sublineages, based on data available up to and including March 2022.

165 nateds decreases by about 10 percentage points, demonstrating the relative efficacy of the booster
 166 vaccination against infections with the Omicron variant. The prevalence of compartments that
 167 count infected individuals decreases with the number of (breakthrough) infections per individual,
 168 which is unsurprising given that the model probability to become infected decreases exponentially
 169 with every new infection. Note that our model cannot, however, track the number of reinfections
 170 per individual between achieving the different vaccination statuses.

171 As under-ascertainment is expected to be larger for infants than for other age groups, we scaled
 172 the respective under-ascertainment ratio to always assume twice the value of other age groups.
 173 Because most children below 5 years of age will remain unvaccinated as per official recommen-
 174 dations, only infections reduce the number of fully susceptible individuals, and, therefore, the
 175 under-ascertainment ratio has a large influence (see Sec. B and Fig. 8). With the degree of under-
 176 ascertainment in this age group comparatively unclear, the results must be considered relatively
 177 uncertain for this age group.

178 IV. CONCLUSION & DISCUSSION

179 As the pandemic progresses, a central quantity that will determine the upcoming dynamics is
180 the population-wide susceptibility against infection with known or future variants of SARS-CoV-2.
181 While protection from infection, either derived from vaccination or natural infection, wanes over
182 time and depends on the circulating virus variant, an estimation of the respective subpopulation
183 sizes of people that suffered from (one or more) infections or were vaccinated/boostered gives
184 valuable information about the size of the population that is, as of yet, still fully susceptible to
185 infection, because these individuals are more prone to infection and severe disease as compared to
186 vaccinated or recovered individuals, given that future variants do not fully escape this immunity.

187 Here, we found that in Germany, a nationwide single-digit percentage of individuals have not
188 been in contact with either a variant of SARS-CoV-2 nor a vaccine against them, yet these results
189 vary between regions and age groups. Despite the high number of reported infections in infants,
190 children, and adolescents, a considerably high percentage of these age groups may still be fully
191 susceptible to infection. This may become problematic if a variant emerges that causes more
192 severe disease in these age groups than previous variants. Yet, we cannot rule out the possibility
193 that we underestimated the extent of under-ascertainment in these age groups, as the factors we
194 used were informed by seroprevalence studies based on blood samples donated by adults (ages
195 18–74), while it has been reported that under-ascertainment ratios can assume values ranging from
196 2 up to 6 or 8 for children [29–31].

197 In comparison, the age groups of adults and elderly showed a relatively low share of fully
198 susceptible individuals, considering infections with all variants, on the order of 5%. Only consid-
199 ering infections with pre-Omicron variants, however, around 7.4%–10.7% of the adult population
200 and 5.3%–7.8% of the elderly population may still be at risk of infection with variants that have a
201 higher probability of causing severe disease than Omicron, potentially causing large outbreaks that
202 could put high pressure on the public health system once again (with these numbers representing
203 quartile ranges).

204 Our results are subject to a number of limitations and biases. For instance, the reported uncer-
205 tainties (quartile ranges) are heavily determined by the choice of distribution of a_ϕ . The distribu-
206 tion we chose has a median value of $Q_2[a_\phi] = 1.7$, which is slightly lower than what was observed
207 in 2020 [18]. Moreover, the lower distribution bound of $\min(a_\phi) = 1$ might be rather low, as such
208 a value would mean that every infection has been reported, which is unlikely. Hence, at least the

209 upper percentiles we report for S_∞ might be overestimations. Furthermore, we assume the same
210 distribution of under-ascertainment ratios for all German states, which might not reflect potential
211 heterogeneities in local ascertainment particularly well.

212 Regarding modeling choices for the eligibility time, a short average duration after infection
213 to be eligible for vaccination leads to larger proportions of vaccine-eligible people and, hence,
214 to a higher overlap between the vaccinated and recovered subpopulations, thus increasing the
215 estimated number of fully susceptibles. While we chose a comparably low value of 90d for this
216 parameter, lower values cannot be ruled out. However, (i) the value we chose lies below the
217 official recommendation, and (ii) changes in this parameter are not expected to change our results
218 drastically, as was shown in a sensitivity analysis.

219 Likewise, shorter durations of eligibility for reinfection and lower values of long-term immu-
220 nity of recovered individuals increase the likelihood that a reported infection of an unvaccinated
221 individual was, in fact, a reinfection event, thus leading to higher values of fully susceptible indi-
222 viduals over all. As above, our results are robust towards variations in these parameters.

223 Regarding results on a regional level, reported vaccinations and infections might be skewed
224 regionally when a large number of people live in one state but traverse to others to seek medical
225 help. These considerations might explain the extreme results observed for Hamburg and Bremen,
226 which are city states enclosed by others.

227 The last German census took place in 2011 and population sizes per age group and region
228 have been imputed for the year 2020 based on this data, thus potentially being subject to over- or
229 under-counting. Uncertainties in population size may introduce systematic errors on the order of a
230 few percentage points in relative frequencies. When such a relative frequency reaches low values,
231 these absolute errors on the order of a few percentage points can lead to high relative errors in the
232 results.

233 Considering incidence rates, we imputed the total number of unvaccinated cases per day from
234 cases with undetermined vaccination status by assigning them the “unvaccinated” status with prob-
235 ability proportional to the share of unvaccinated cases in the set of cases with determined status.
236 This procedure can introduce systematic errors when the ascertainment of vaccination status is bi-
237 ased towards any of the vaccination states, which may occur, for instance, when the probability of
238 status ascertainment increases with severity of disease. In this case, people with breakthrough in-
239 fections may be less likely to have their vaccination status reported in the reporting system, which
240 would mean that we overestimated the number of unvaccinated cases per day, introducing a bias

241 towards lower values of the share of fully susceptible individuals.

242 For analyses regarding infections with variants prior to Omicron, we relied on the nationwide
243 share of Omicron sequences, multiplying all incidence rates (regardless of region, age, or vaccine
244 status) with this function. Since vaccines assume different efficacies against infection with differ-
245 ent variants and will likely vary across ages and regions, this assumption is expected to introduce
246 strong bias on a fine-grained population level, which may be expected to decrease when values are
247 aggregated over regions or ages.

248 Our results cannot be used to predict the future course of the pandemic directly. In fact, since
249 SARS-CoV-2 lacks phenotypical stability and neither infection nor vaccination elicit full long-
250 term protective immunity, especially with respect to the prevention of infection and transmission,
251 there are doubts that classical herd immunity can be reached for COVID-19 [32]. In several stud-
252 ies, hybrid immunity resulting from infection-acquired immunity boosted with vaccination con-
253 ferred the strongest, or longer-lasting protection, respectively [33, 34]. Similarly, Omicron break-
254 through infections in previously vaccinated individuals have been shown to drive cross-variant
255 neutralization and memory B cell formation [35], suggesting that a combination of both, natural
256 infection and vaccination, will have more impact on the future COVID-19 epidemiology than one
257 of the events alone.

258 To sum up, our study shows that, presumably, only a small part of the German population has
259 not yet been in contact with either a variant of SARS-CoV-2 or a respective vaccine against the
260 disease they cause, up to and including March 2022. We show important proportions of fully
261 susceptible elderly, who on average, by their age and age-associated morbidities, have a dispro-
262 portionately elevated risk of severe disease. These shares differ by region and could motivate
263 regionally targeted protection measures at the time of writing or in case of future outbreaks.

264 While the immunization campaign was successful in spring and summer 2021, in particular
265 reaching a large proportion of vulnerable people, it thereafter had difficulties to completely close
266 immunity gaps with vaccinations, albeit enhancing the protection of a large proportion of already
267 vaccinated people with a large booster vaccination campaign by the end of 2021. Our results
268 show that the Omicron wave had a high impact on naturally closing the aforementioned gaps. As
269 mentioned above, however, having been in contact with a variant of SARS-CoV-2 is not a robust
270 equivalent of immunity and may range from mild infection followed by rapid waning of antibodies
271 and a highly uncertain degree of immunity, to a fully vaccinated status including a booster and a
272 breakthrough infection, which confers a more long-lasting and robust degree of protection against

273 severe disease. At the lower end of this spectrum of presumed immunity, our analyses show that
274 one in six persons was never vaccinated but infected once or more, in the majority of cases with
275 Omicron. This group faces higher uncertainties for the upcoming fall and winter since protection
276 against severe disease may be more short-lived and too narrowly targeted to this variant.

277 ACKNOWLEDGMENTS

278 The authors would like to thank Maria Waize and Matthias an der Heiden for helpful discus-
279 sions. B.F.M. is supported as an *Add-on Fellow for Interdisciplinary Life Science* by the Joachim
280 Herz Stiftung.

281 Appendix A: Main model

282 1. Model formulation

We partition the population into $n_G = 16$ regions corresponding to the German states and $n_A = 5$ age groups corresponding to ages “00-04” (infants), “05-11” (children), “12-17” (adolescents), “18-59” (adults), “60+” (elderly), chosen in accordance with the population structure of publicly available vaccination data [2]. Consequently, for any region- and age-specific compartment $X_{A,G}$, the nation-wide value is given as

$$X_A = \sum_{G=1}^{n_G} X_{A,G}, \quad (\text{A1})$$

the corresponding value for all ages is given as

$$X_G = \sum_{A=1}^{n_A} X_{A,G}, \quad (\text{A2})$$

and the total value is

$$X_{\text{tot}} = \sum_{A=1}^{n_A} \sum_{G=1}^{n_G} X_{A,G}. \quad (\text{A3})$$

283 Because in the further analysis, none of the subpopulations are interacting, we will omit the region-
284 and age-determining subscripts for simplicity.

For any population of size N , we are first and foremost interested in the number of susceptible individuals S , i.e. the number of individuals that have never been in contact with neither a variant

of SARS-CoV-2, nor a vaccine against it. We assume that previous to the pandemic, no individual has had contact with any variant of SARS-CoV-2 or a vaccine against them, i.e. $S(t = 0) = N$. These susceptibles can then either (i) become infected (changing their status to I) or (ii) vaccinated (changing their status to V). The number of individuals changing their status per day is estimated from official data [2, 36], defining the number of reported newly infected unvaccinated individuals per day as ϕ_S and the number of newly vaccinated individuals per day as $\beta_S(t)$. We obtain these rates on a calendar-week basis in order to remove weekly modulations. Because the vaccination status of new infections is unknown for a considerable amount of people, we impute ϕ_S from incomplete incidence data in a procedure outlined further below. The rates are to be interpreted in a way such that

$$M_S = \int_0^{t_{\max}} dt \beta_S(t), \quad \text{and} \quad (\text{A4})$$

$$F_S = \int_0^{t_{\max}} dt \phi_S(t) \quad (\text{A5})$$

285 give the cumulative number of vaccinated individuals and the cumulative number of reported in-
 286 fections of unvaccinated individuals, respectively, both up to time t_{\max} .

At any time t , the number of individuals eligible to receive a vaccine is proportional to (a) the number of susceptible individuals and (b) the number of recovered individuals. We assume that infected individuals become eligible for vaccination after an average amount of time τ passes. Hence, after obtaining an infection, we assume that individuals change their status with rate $1/\tau$ to become eligible (status Y). Then, the probability for a person that becomes vaccinated at time t to be of status S is given as $p_{V,S} = S/(S+Y)$ and for status Y as $p_{V,I} = Y/(S+Y)$. Consequently, the vaccination transition rate for both susceptibles and eligible recovered to receive vaccination status is given as

$$\tilde{\beta}_S = \frac{a_\beta \beta_S}{S+Y}. \quad (\text{A6})$$

Here, we further introduced the under-ascertainment ratio of vaccinations a_β . The corresponding transition processes are

$$S \xrightarrow{\tilde{\beta}_S} V \quad (\text{A7})$$

$$Y \xrightarrow{\tilde{\beta}_S} C_{IV} \quad (\text{A8})$$

where C_{IV} represents the compartment counting individuals who became infected at least once before receiving a vaccination.

$$I \xrightarrow{1/\tau} Y \quad (\text{A9})$$

287 represents the process of recovered individuals becoming eligible for vaccination.

Similarly, the number of individuals eligible to transition to status “unvaccinated infected” is proportional to (a) the number of susceptible individuals and (b) the number of recovered individuals that are eligible for reinfection. We assume that individuals that recently suffered from an infection are fully immune, but may return to (partial) susceptibility after an average duration of τ , equating this to the average duration it takes to become eligible for vaccination for model parsimony and reasons outlined further below. Because reinfections are not registered in the German reporting system, we have to consider the relative probability for a recovered person to be reinfected by introducing an “immunity parameter” r that represents the relative probability of a recovered person to become infected after time τ since the last infection as compared to a fully susceptible person. Hence, the total number of people eligible to be counted as an infection of an unvaccinated individual at time t is given as $S + (1 - r)Y$, the probability that an unvaccinated person that becomes infected at time t has been infected before is $p_{I,I} = (1 - r)Y / (S + (1 - r)Y)$, and $p_{I,S} = S / (S + (1 - r)Y)$ that they have been fully susceptible. Consequently, the eligibility-corrected vaccination rate is given as

$$\tilde{\phi}_S = \frac{a_\phi \phi_S}{S + (1 - r)Y}. \quad (\text{A10})$$

Here, a_ϕ is the under-ascertainment ratio, accounting for infections that have not been reported. The corresponding transition processes are

$$S \xrightarrow{\tilde{\phi}_S} I \quad (\text{A11})$$

$$Y \xrightarrow{(1-r)\tilde{\phi}_S} I. \quad (\text{A12})$$

288 Again, Eq. (A9) represents the process of becoming eligible (both for vaccination after infection
289 and reinfection).

Continuing with this line of argumentation, we further consider the adjusted rate of individuals that obtain a breakthrough infection as

$$\tilde{\phi}_V = \frac{\phi_V}{V + (1 - r)C_{VY} + C_{IV} + (1 - r)C_{IVY}}. \quad (\text{A13})$$

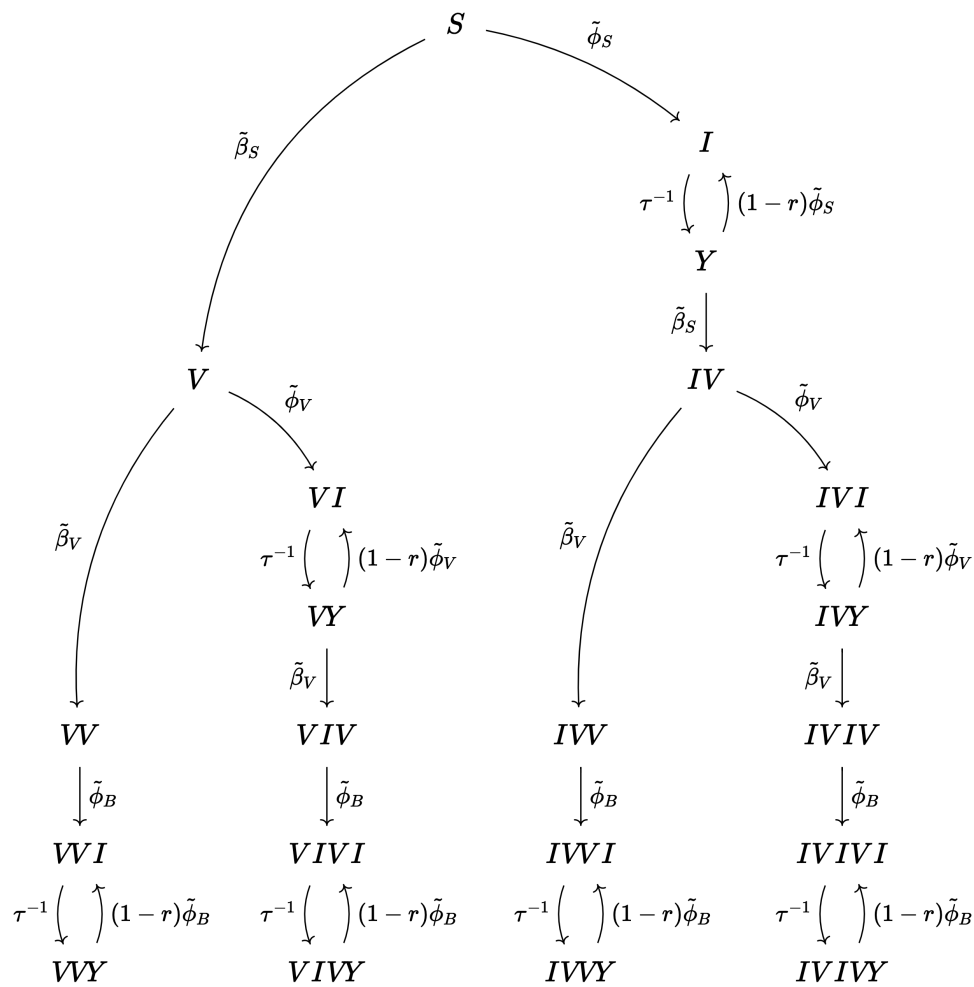

FIG. 5. Vaccination/infection model given by Eqs. (A6)-(A36). Individuals can become infected and recover (compartments ending in I), vaccinated (compartments ending in V), or eligible for reinfection/vaccination after a previous infection after an average duration of τ^{-1} (compartments ending in Y). Initially, all individuals are susceptible (S). Transition rates are determined by data and scaled by assumed under-ascertainment ratios (not shown here). Individuals that are eligible for reinfection are associated with a relative reduction in susceptibility r . The order of I and V in individual statuses represent the order in which infections and vaccinations happened to the respective individuals.

290 Here, C_{VY} are vaccinated individuals that suffered from a breakthrough infection before, and C_{IVY}
 291 counts individuals that, after recovery became vaccinated, then suffered from a breakthrough in-
 293 fection again. The respective transition processes are displayed in Fig. 5.

Similarly, the adjusted booster rate

$$\tilde{\beta}_V = \frac{\beta_V}{V + C_{VY} + C_{IV}} \quad (\text{A14})$$

²⁹⁴ quantifies the rate with which previously vaccinated individuals receive a booster vaccination (pro-
²⁹⁵ cesses shown in Fig. 5).

Finally, the adjusted booster breakthrough rate is

$$\tilde{\phi}_B = \frac{\phi_B}{C_{VV} + C_{VIV} + C_{IVV} + C_{IVIV} + (1-r) [C_{VYY} + C_{VIVY} + C_{IVVY} + C_{IVIVY}]} \quad (\text{A15})$$

²⁹⁶ For every compartment C_{\bullet} , the order of I and V in the subscript \bullet represents the order in which
²⁹⁷ infections and vaccinations happened to the individuals counted in the respective compartment.

In total, the model is determined by the following set of ordinary differential equations (ODEs)

$$\partial_t S = -\tilde{\phi}_S S - \tilde{\beta}_S S \quad (\text{A16})$$

$$\partial_t V = \tilde{\phi}_S S - \tilde{\beta}_V V - \tilde{\phi}_V \quad (\text{A17})$$

$$\partial_t I = \tilde{\beta}_S S + (1-r)\tilde{\phi}_S Y - I/\tau \quad (\text{A18})$$

$$\partial_t Y = I/\tau - (1-r)\tilde{\phi}_S Y - \tilde{\beta}_S Y \quad (\text{A19})$$

$$\partial_t C_{IV} = \tilde{\beta}_S Y - \tilde{\beta}_V C_{IV} - \tilde{\phi}_V C_{IV} \quad (\text{A20})$$

$$\partial_t C_{VI} = \tilde{\phi}_V V + (1-r)\tilde{\phi}_V C_{VY} - C_{VI}/\tau \quad (\text{A21})$$

$$\partial_t C_{VY} = C_{VI}/\tau - (1-r)\tilde{\phi}_V C_{VY} - \tilde{\beta}_V C_{VY} \quad (\text{A22})$$

$$\partial_t C_{IVI} = \tilde{\phi}_V C_{IV} + (1-r)\tilde{\phi}_V C_{IVY} - C_{IVI}/\tau \quad (\text{A23})$$

$$\partial_t C_{IVY} = C_{IVI}/\tau - (1-r)\tilde{\phi}_V C_{IVY} - \tilde{\beta}_V C_{IVY} \quad (\text{A24})$$

$$\partial_t C_{VV} = \tilde{\beta}_V V - \tilde{\phi}_B C_{VV} \quad (\text{A25})$$

$$\partial_t C_{VIV} = \tilde{\beta}_V C_{VY} - \tilde{\phi}_B C_{VIV} \quad (\text{A26})$$

$$\partial_t C_{IVV} = \tilde{\beta}_V C_{IV} - \tilde{\phi}_B C_{IVVI} \quad (\text{A27})$$

$$\partial_t C_{IVIV} = \tilde{\beta}_V C_{IVY} - \tilde{\phi}_B C_{IVIV} \quad (\text{A28})$$

$$\partial_t C_{VVI} = \tilde{\beta}_B C_{VV} + (1-r)\tilde{\phi}_B C_{VVY} - C_{VVI}/\tau \quad (\text{A29})$$

$$\partial_t C_{VIVI} = \tilde{\beta}_B C_{VIV} + (1-r)\tilde{\phi}_B C_{VIVY} - C_{VIVI}/\tau \quad (\text{A30})$$

$$\partial_t C_{IVVI} = \tilde{\beta}_B C_{IVVI} + (1-r)\tilde{\phi}_B C_{IVVY} - C_{IVVI}/\tau \quad (\text{A31})$$

$$\partial_t C_{IVIVI} = \tilde{\beta}_B C_{IVIV} + (1-r)\tilde{\phi}_B C_{IVIVY} - C_{IVIVI}/\tau \quad (\text{A32})$$

$$\partial_t C_{VVY} = -(1-r)\tilde{\phi}_B C_{VVY} + C_{VVI}/\tau \quad (\text{A33})$$

$$\partial_t C_{VIVY} = -(1-r)\tilde{\phi}_B C_{VIVY} + C_{VIVI}/\tau \quad (\text{A34})$$

$$\partial_t C_{IVVY} = -(1-r)\tilde{\phi}_B C_{IVVY} + C_{IVVI}/\tau \quad (\text{A35})$$

$$\partial_t C_{IVIVY} = -(1-r)\tilde{\phi}_B C_{IVIVY} + C_{IVIVI}/\tau. \quad (\text{A36})$$

298 2. Parameters and data

299 a. Incidence by vaccination status

For each combination of age group and region, we obtain the daily number of reported new cases in unvaccinated $\hat{n}_S(t)$ by ‘‘Meldedatum’’ (date of report), as well as the daily number of

reported breakthrough infections $\hat{n}_V(t)$, reported booster breakthrough infections $\hat{n}_B(t)$, as well as the daily number of infections where the vaccination status is unknown $\hat{n}_\emptyset(t)$ from the German reporting system SurvStat [25]. In order to assign vaccination statuses to cases where the status is originally unknown, we measure the proportion of infections per status in cases with known status in the last seven days and subsequently obtain the imputed number of daily cases as

$$n_X(t) = \hat{n}_X(t) + \hat{n}_\emptyset(t) \frac{\sum_{t'=t-6d}^t \hat{n}_X(t')}{\sum_{t'=t-6d}^t [\hat{n}_S(t') + \hat{n}_V(t') + \hat{n}_B(t')]}, \quad \forall X \in \{S, V, B\}. \quad (\text{A37})$$

This procedure removes weekly modulations for the imputation. It might be biased towards any of the statuses S, V, B due to different probabilities of severe disease by vaccination status and thus of being reported in a system of primarily symptom-based testing. Note that, for no region and age groups there were days for which $\mathfrak{N} = \sum_{t'=t-6d}^t [\hat{n}_S(t') + \hat{n}_V(t') + \hat{n}_B(t')] = 0$ and $\hat{n}_\emptyset(t) > 0$, which is why we set $n_X(t) = \hat{n}_X(t)$ on days where $\mathfrak{N} = 0$. With the above definition, the infection rates are given as

$$\phi_X(t) = \frac{1}{|\mathcal{W}(t)|} \sum_{t' \in \mathcal{W}(t)} n_X(t'), \quad \forall X \in \{S, V, B\} \quad (\text{A38})$$

300 where $\mathcal{W}(t)$ is the set of days t' in calendar week of day t meeting $t' < t_{\max}$.

301 *b. Vaccination rates*

Similarly, weekly vaccination rates are given as

$$\beta_X(t) = \frac{1}{|\mathcal{W}(t)|} \sum_{t' \in \mathcal{W}(t)} \hat{v}_X(t'), \quad \forall X \in \{S, V\} \quad (\text{A39})$$

302 with $\hat{v}_S(t)$ and $\hat{v}_V(t)$ being the number of new vaccinations (new booster vaccinations, respec-
 303 tively) on day t . We define “new vaccinations” as entries in the data provided in [2] that have
 304 an “Impfschutz”-field value of “2”, and as “new booster vaccinations” as entries that have an
 305 “Impfschutz”-field value of “3”, ignoring single-shot vaccinations with value “1” (in the data,
 306 confirmed recovered individuals that received a single vector- or mRNA-vaccine dose are counted
 307 as being fully vaccinated with an “Impfschutz”-field value of “2”). The share of the population
 308 that received only one dose of an mRNA or the Vaxzevria vaccine is expected to be on the order
 309 of 1% of the German population up to and including March 2022 [2]. In the model, the infection
 310 of these individuals follows the same dynamics as the infection of fully susceptible individuals.
 311 Hence, ignoring this vaccination state will barely affect the results.

312 Note that we ignore the small number of vaccinations associated with the region “Bund” (region
313 id “17”).

314 *c. Under-ascertainment*

315 Based on seroprevalence data collected over the first waves in Germany, a nation-wide under-
316 ascertainment ratio of $a_\phi \approx 2$ was found, with regional variations that went up to a factor of $a_\phi \approx 5$
317 in regions of large outbreaks [10, 18]. In absence of more fine-grained and temporally resolved
318 estimations, we assume an under-ascertainment of $a_\phi = 1 + \hat{a}_\phi$ with \hat{a}_ϕ being a Gamma-distributed
319 random variable such that $\langle a_\phi \rangle = 2$ and $\text{Std}[a_\phi] = 1$.

320 It has further been reported that there might be low under-ascertainment in vaccinations [37].
321 We assume an under-ascertainment of $a_\beta = 1 + \hat{a}_\beta$ with \hat{a}_β being a Gamma-distributed random
322 variable such that $\langle a_\beta \rangle = 1.03$ and $\text{Std}[a_\beta] = 0.02$.

323 Infants are less likely to display symptoms when infected and are not subject to the strict testing
324 strategies applied in schools [38]. A lower ascertainment in this age group is, therefore, a plausible
325 assumption. We hence assume double the value of the under-ascertainment ratio for this age group.

326 *d. Eligibility time and immunity of recovered individuals*

327 We assume an average eligibility time of $\tau = 90\text{d}$ for vaccination after infection or reinfection.
328 Regarding reinfection, this is a reasonable time scale, as it is of the order of the mean duration
329 neutralising antibodies can be found after an infection. For vaccinations, the official assumption
330 for receiving a vaccine after infection has been 3–6 months. In non-representative survey data,
331 it was found that participants generally followed these recommendations, with a large number of
332 participants waiting less and became vaccinated about 3 months after a confirmed infection. While
333 the cohort of this study is assumed to be composed of highly compliant individuals, the average
334 time to receive a vaccination is also lowered assuming a large number of asymptomatic infections,
335 where the date of the infection might be unknown to recovered individuals themselves. Note,
336 however, that we test the influence of this parameter on our results in a sensitivity analysis (see
337 App. B).

338 We recognize that recovered individuals might still have a lowered susceptibility for reinfection
339 even after transitioning to the eligibility state. The “recovered immunity” parameter r quantifies

340 the relative efficacy against reinfection. For the Alpha variant, this efficacy was observed to be
341 lower than the vaccine efficacy against infection by mRNA- or vector-vaccines [24], but of similar
342 order as the vaccine efficacy against Infection with Delta, taking on values of $r \approx 0.65$ for both. As
343 Omicron is considered to be a variant with partial immune escape, we set a lower default value of
344 $r = 1/2$ for all variants, testing $r = 0$ (no protection against reinfection) and $r = 1$ (full immunity)
345 in sensitivity analyses.

346 e. Variant share

For analyses disregarding infections with Omicron, we obtained sequences that were sampled randomly nation-wide and independent of age [26]. For each calendar week w we obtained the total number $m(w)$ of randomly sampled sequences with date of extraction t that lie in w . We further aggregated the number $m_o(w)$ of randomly sampled sequences that the software framework “scorpio” identified as “Omicron” or “Probable Omicron”. Then, the share of Omicron on day t is given as

$$\sigma(t) = \begin{cases} 0, & t < \text{Aug 1, 2021} \\ 1, & w(t) > w_{\max} \\ m_o(w(t))/m(w(t)) & \text{otherwise,} \end{cases} \quad (\text{A40})$$

347 with w_{\max} being the last week for which data was available.

348 For analyses labeled “pre-Omicron” we analyzed the model with all incidence rates being
349 scaled as $\phi_{\bullet, \text{pre-Omicron}}(t) = \phi_{\bullet}(t)[1 - \sigma(t)]$.

350 f. Simulations

We draw 1,000 pairs of (a_{ϕ}, a_{β}) as described above and assume those under-ascertainment ratios to be constant across all respective ages and regions (bar infants, whose under-ascertainment ratio is set as $a_{\phi, \text{infants}} = \omega a_{\phi}$ with $\omega = 2$ to account for the fact that under-ascertainment is expected to be higher in this age group). Then, Eqs. (A16)–(A36) are integrated with Euler’s method using a time step of $\Delta t = 1\text{d}$, starting on Jan 6, 2020 until March 31, 2022. We then obtain the final state

of the compartments, and additionally aggregated states as

$$C_{I^*} = I + Y \quad (\text{A41})$$

$$C_{VI^*} = C_{VI} + C_{VY} \quad (\text{A42})$$

$$C_{IVI^*} = C_{IVI} + C_{IVY} \quad (\text{A43})$$

$$C_{VVI^*} = C_{VVI} + C_{VVY} \quad (\text{A44})$$

$$C_{VIVI^*} = C_{VIVI} + C_{VIVY} \quad (\text{A45})$$

$$C_{IVVI^*} = C_{IVVI} + C_{IVVY} \quad (\text{A46})$$

$$C_{IVIVI^*} = C_{IVIVI} + C_{IVIVY} \quad (\text{A47})$$

$$C_{0VI} = I + Y \quad (\text{A48})$$

$$C_{1V0I} = V \quad (\text{A49})$$

$$C_{1V1I} = C_{IV} + C_{VI} + C_{VY} \quad (\text{A50})$$

$$C_{1V2I} = C_{IVI} + C_{IVY} \quad (\text{A51})$$

$$C_{2V0I} = C_{VV} \quad (\text{A52})$$

$$C_{2V1I} = C_{VIV} + C_{IVV} + C_{VVI} + C_{VVY} \quad (\text{A53})$$

$$C_{2V2I} = C_{IVIV} + C_{VIVI} + C_{IVVI} + C_{VIVY} + C_{IVVY} \quad (\text{A54})$$

$$C_{2V3I} = C_{IVIVI} + C_{IVIVY} \quad (\text{A55})$$

$$C_{1V} = V + C_{IV} + C_{VI} + C_{IVI} + C_{VY} + C_{IVY} \quad (\text{A56})$$

$$C_{2V} = C_{VV} + C_{VIV} + C_{IVV} + C_{IVIV} + C_{VVI} + C_{VIVI} +$$

$$+ C_{IVVI} + C_{IVIVI} + C_{VVY} + C_{VIVY} + C_{IVVY} + C_{IVIVY} \quad (\text{A58})$$

$$C_{1I} = I + Y + C_{IV} + C_{VI} + C_{VY} + C_{VIV} + C_{IVV} + C_{VVI} + C_{VVY} \quad (\text{A59})$$

$$C_{2I} = C_{IVI} + C_{IVY} + C_{IVIV} + C_{VIVI} + C_{IVVI} + C_{VIVY} + C_{IVVY} \quad (\text{A60})$$

$$C_{3I} = C_{IVIVI} + C_{IVIVY}. \quad (\text{A61})$$

351 These states combine compartments that have certain commonalities, e.g. compartments C_{nVmI}
 352 is the number of individuals that were vaccinated n times and infected m times (re-infections
 353 excluded), C_{nV} is the number of individuals that were vaccinated n times, and C_{mI} is the number
 354 of individuals that were infected m times (re-infections excluded, which means that if an individual
 355 was infected $m = 3$ times, they must have been infected before, between, and after the respective
 356 inoculations.

357 We test how robust our results are if per region and age group, individual pairs (a_ϕ, a_β) were
358 drawn from their respective distribution, i.e. assuming heterogeneous under-ascertainment in ages
359 and regions per simulation run, which could potentially change the width of the distribution of
360 respective aggregated values, finding that it does not have a substantial effect.

361 The results of these simulations can be obtained from [39].

362 **Appendix B: Sensitivity and other analyses**

363 Nation-wide results for all compartments as well as Eqs. ((A41)–(A61)) can be found in Fig. 6.
364 The compartment with the largest share of the population is C_{VV} , i.e. boosted and never in-
365 fected, assuming a value of 45.8% [41.1%–49.0%]. Considering all variants, the second largest
366 value can be found for individuals that have never been vaccinated but infected once or more with
367 C_{I^*} assuming 14.9% [12.0%–18.1%]. This value is considerably lower (5.6% [4.3%–7.5%]) when
368 infections with Omicron are excluded. Likewise, the share of vaccinated, yet non-infected indi-
369 viduals V is estimated to assume 14.6% [13.4%–15.3%] with Omicron infections excluded, but
370 8.6% [5.8%–10.6%] considering all variants. With Omicron infections excluded, the boosted
371 and non-infected population assumes an estimated size of 54.9% [53.1%–56.2%], demonstrating
372 the increased efficacy of the booster vaccination against infection with Omicron as compared to
373 individuals who only finished the first vaccination series.

374 Regarding the influence of eligibility time, higher values lead to a lower probability of reinfec-
375 tions and vaccinations of recovered individuals during the most active period of the vaccination campaign,
376 implying the estimated number of fully susceptible individuals decreases with increasing τ . Like-
377 wise, the assumed immunity of recovered individuals r leads to a decreasing value of fully susceptible in-
378 dividuals. The results we reported above lie central within the range of results for extreme value
379 pairs of $\tau = 30\text{d}$, $r = 0$ (low), as well as $\tau = 150\text{d}$, $r = 1$ (high). For instance for all ages, the
380 results vary between median values of 9.5% (low) and 4.6% (high) with our reported result in the
381 main text ($\tau = 90\text{d}$, $r = 0.5$) being equal to 7.0%. The influence of these parameters are higher
382 for the younger population with a “low“-to-“high“ variation leading to respective median ranges
383 of 51.0% to 38.8% (infants), 31.5% to 14.0% (children), and 10.3% to 1.3% (adolescents). In the
384 older population, the influence of these parameters is rather small, leading to median ranges of
385 5.4% to 1.5% (adults) and 5.1% to 3.3% (elderly). These results are displayed in Fig. 7.

386 In the main text, we assumed that the relative under-ascertainment factor in infants assume a

387 value of $a_{\phi, \text{infants}}/a_{\phi} = \omega = 2$. For $\omega = 1$, fully susceptible infants is higher than what we reported
388 in the main text (see Fig. 8. Since empirical values for ω are difficult to obtain, we are probably
389 underestimating the uncertainty in our results for infants.

390 **Appendix C: Additional, sophisticated Model**

391 We further want to develop a model that allows waning to be included in the analyses and could
392 therefore potentially be used to estimate seroprevalence in future studies.

393 We hypothesize that exposure to either the pathogen or a vaccine results in an initial immune
394 response that then decays over a period of time and account for this by introducing intermediate
395 compartments representing different gradations of immunity.

We define as S susceptibles, I infected, V vaccinated, Y breakthroughs from vaccinated V and
 U as breakthroughs from boosted B . For each compartment X , we consider $n_X + 1$ gradations,
i.e. we assume that individuals who reach the status X pass through intermediate compartments
in the form of a chain from initial X_0 to final X_{n_X} , per transition $X_i \rightarrow X_{i+1}$ with transition rate
 $1/\tau_{X,i+1}$. This means that for each individual, each of these transitions is subject to a random delay

$$T_{X,i} \sim \text{Exp}(1/\tau_{X,i+1}) \quad (\text{C1})$$

396 where $\text{Exp}(\lambda_X)$ is an exponential distribution with mean λ_X^{-1} . This approach allows us to more ac-
397 curately model both waning of immunity and the timing of vaccination or breakthrough infection.
398 For susceptibles, we set $n_S = 0$, i.e. no transitions and exactly one gradation.

We denote \hat{X} as the total number of individuals in status X that are susceptible to infection.
That is, we define

$$\hat{X} = \sum_{i=0}^{n_X} (1 - e_{X,i}) X_i, \quad (\text{C2})$$

399 where $e_{X,i}$ is the susceptibility reduction of a person in status X_i (due to previous infection or
400 vaccination).

We define \tilde{X} as the total number of individuals in status X who can receive one or the next
vaccination. Usually, this is the case after a defined time Θ_X has passed since the last infection or
the last receipt of a vaccine dose (comparable to the ‘eligibility time’ used in the main analyses of
this study). The total time it takes for an individual in status X_i to reach status X_{i+1} is given by the

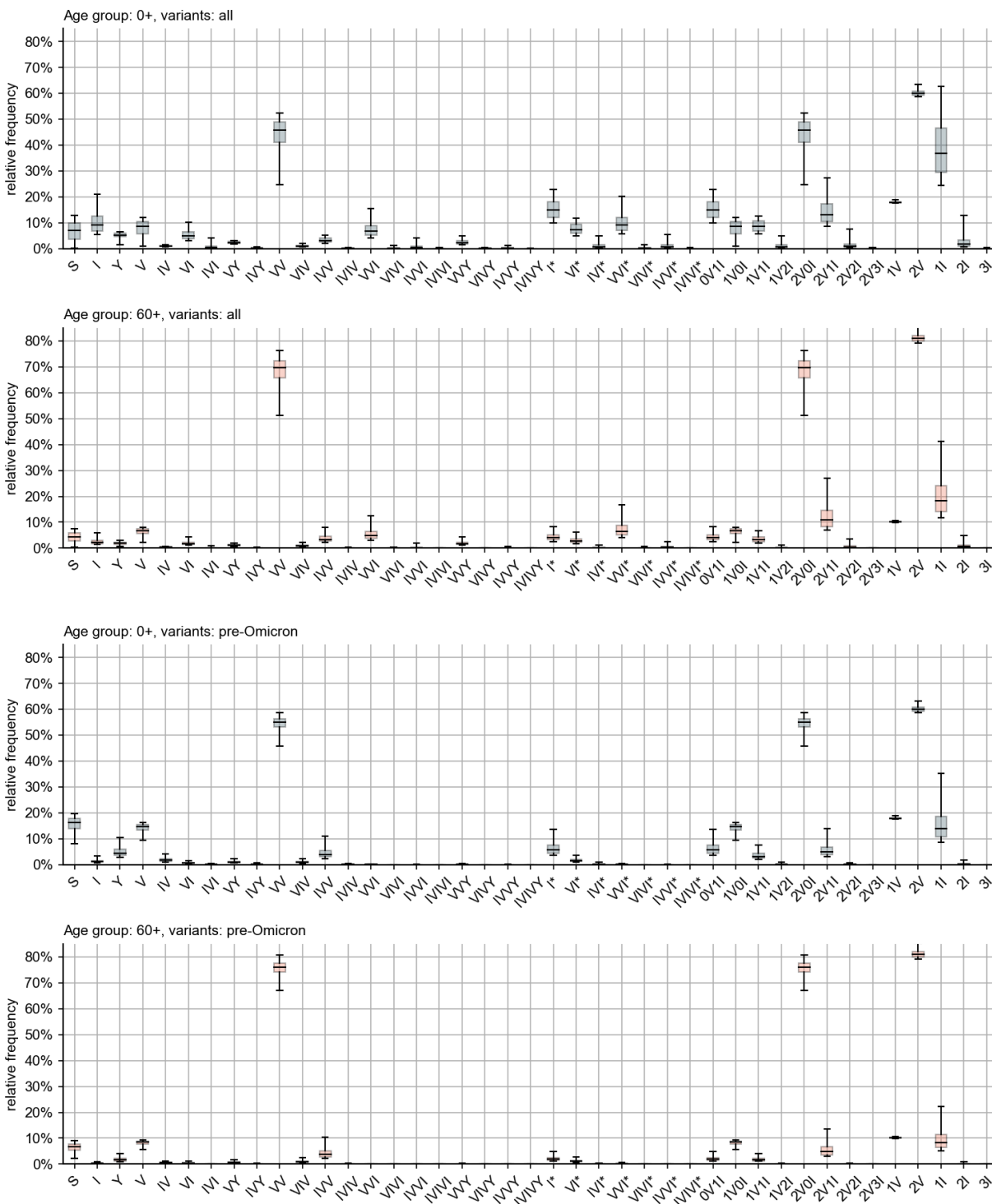

FIG. 6. Relative frequency of all compartments given by vaccination and infection status across Germany, for all age groups and variants as well as for the elderly and pre-Omicron variants. Some compartments shown are aggregates, e.g. labels “ $nVmI$ ” represent the number of individuals that were vaccinated n times and infected m times (re-infections excluded), labels “ nV ” give the number of individuals that were vaccinated n times, and labels “ mI ” are the number of individuals that were infected m times (re-infections excluded), see Eqs. ((A41))–((A61))

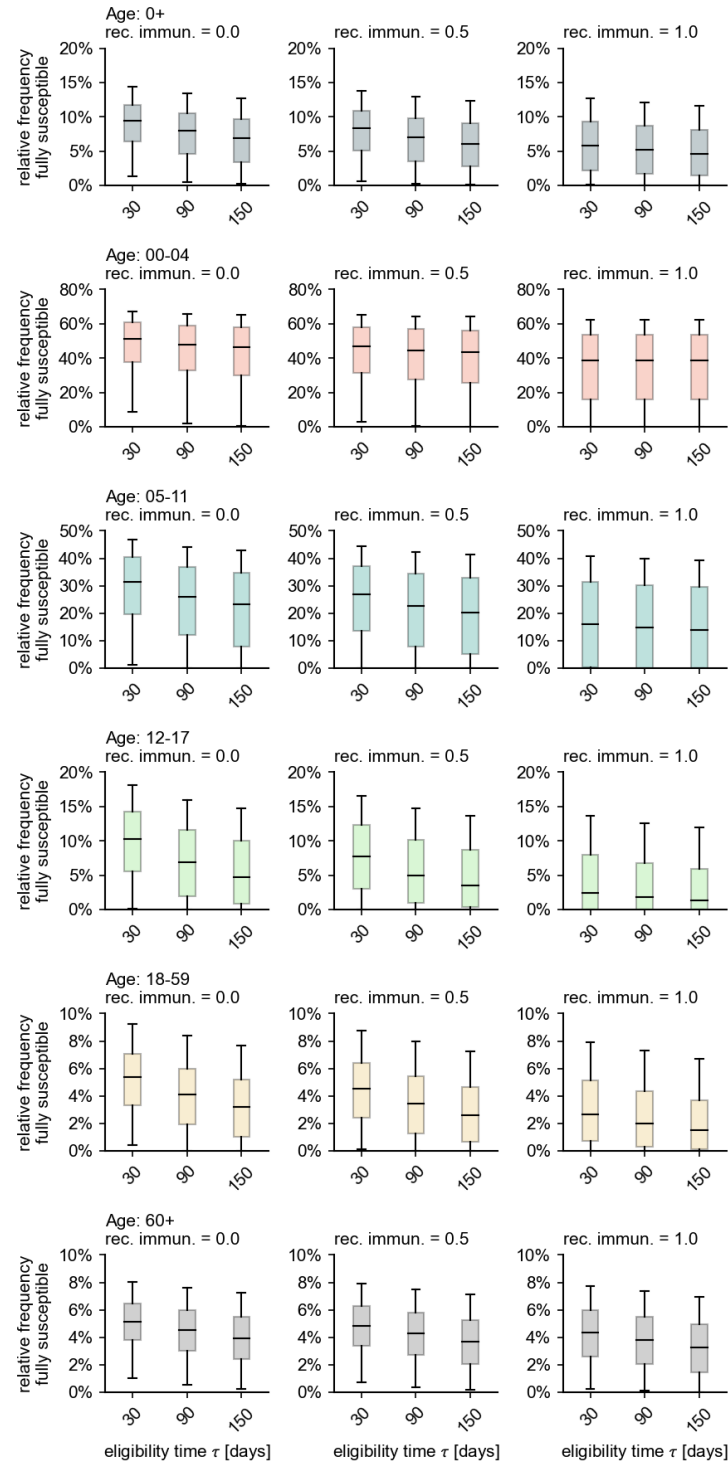

FIG. 7. The influence of the assumed average eligibility duration as well as the long-term immunity of recovered individuals.

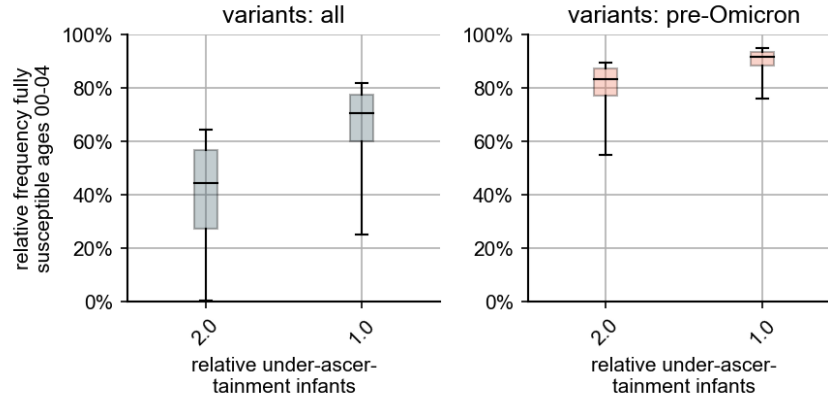

FIG. 8. Influence of relative under-ascertainment for infants. For the main results, we assumed that the relative under-ascertainment factor assumes, for infants, a value of $a_{\phi, \text{infants}}/a_{\phi} = \omega = 2$. For $\omega = 1$, the number of yet fully susceptible infants is higher than what we reported in the main text.

random variable

$$Z_{X,i} = \sum_{j=0}^i T_{X,j}. \quad (\text{C3})$$

Let $F_{X,i}(z)$ be the cumulative distribution function of the random variable $Z_{X,i}$. Then, the probability $w_{X,i}$ that a given individual in status X_i has been in status X for longer than Θ_X is given by

$$w_{X,i} = P(Z_{X,i} > \Theta_X) = 1 - F_{X,i}(\Theta_X). \quad (\text{C4})$$

We find such

$$\tilde{X} = \sum_{i=0}^{n_X} [1 - F_{X,i}(\Theta_X)] X_i. \quad (\text{C5})$$

401 The probabilities $w_{X,i} = 1 - F_{X,i}(\Theta_X)$ are constant and can thus be determined numerically after
 402 defining the times $\{\tau_{X,i}\}$ and Θ_X . For susceptibles, let $S = \hat{S} = \tilde{S}$.

Let $\mathcal{I}(X)$ be the compartment to which an individual in status X transitions after infection and $\mathcal{V}(X)$ be the compartment to which an individual in status X transitions after vaccination. We define the following transitions

$$\mathcal{I}(S) = \mathcal{I}(I) = I \quad (\text{C6})$$

$$\mathcal{V}(S) = \mathcal{V}(I) = V, \quad (\text{C7})$$

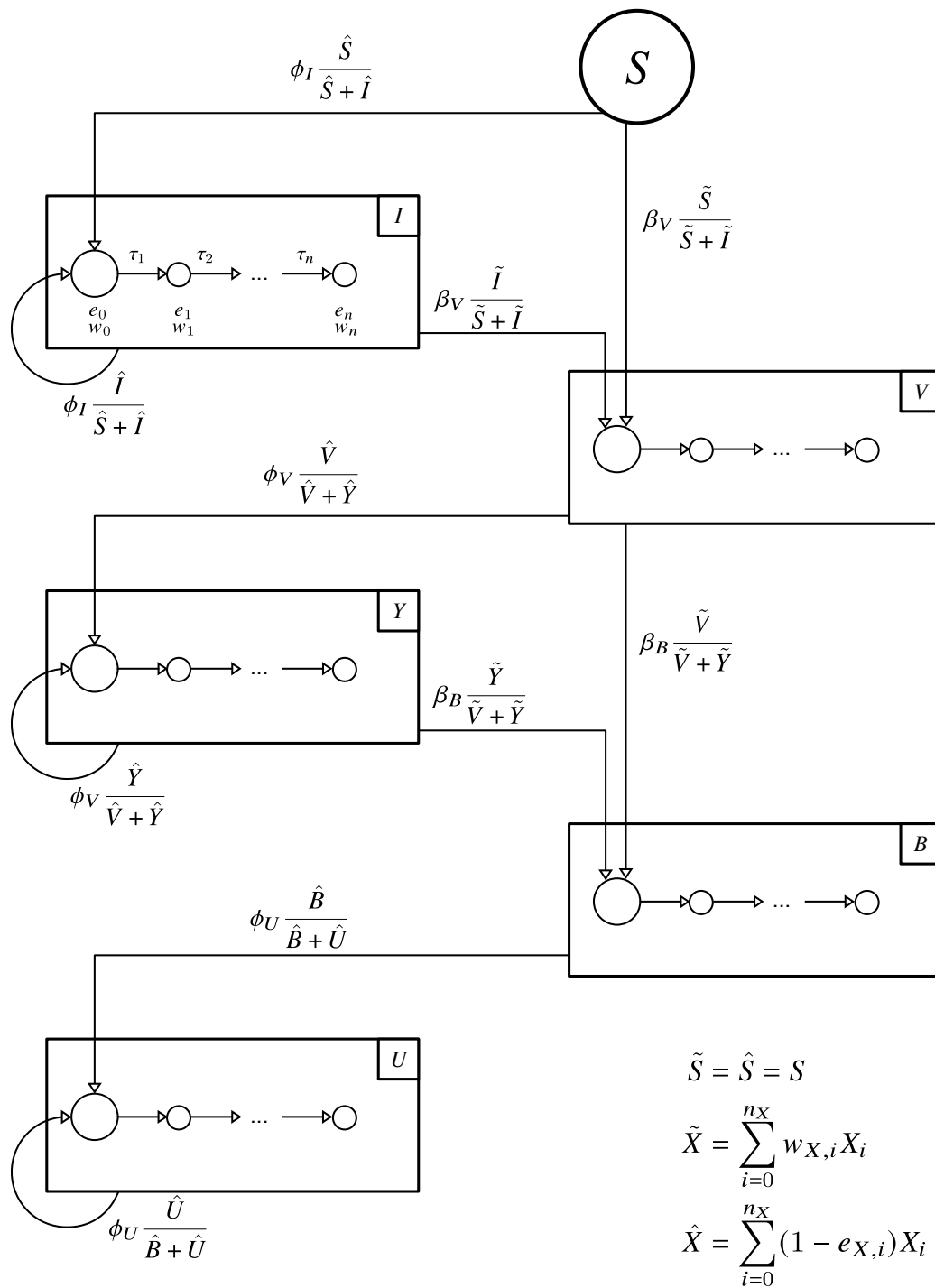

FIG. 9. Detailed model that includes waning.

i.e. susceptibles S who become infected transition to status I and susceptibles who are vaccinated transition to status V . Recovered I who become infected again transition to status I and recovered people who get vaccinated transition to status V . Furthermore,

$$\mathcal{I}(V) = \mathcal{I}(Y) = Y \quad (\text{C8})$$

$$\mathcal{V}(V) = \mathcal{V}(Y) = B, \quad (\text{C9})$$

i.e. vaccinated individuals V who become infected transition to status Y and those vaccinated that receive a third dose transition to status B . Breakthrough-recovereds Y who become reinfected again transition to status Y and breakthrough-recovered individuals who become vaccinated transition to status B . Last,

$$\mathcal{I}(B) = \mathcal{I}(U) = U \quad (\text{C10})$$

$$\mathcal{V}(B) = \mathcal{V}(U) = \emptyset, \quad (\text{C11})$$

i.e. boosted persons B who become infected transition to status U but further vaccination is not provided. Recovered booster vaccinated persons U who become infected again will again transition to status U . The dynamics of all states X_i follows

$$\partial_t X_i = \underbrace{\phi_X \delta_{i,0} - \phi_{\mathcal{I}(X)} (1 - e_{X,i}) X_i}_{\text{infections}} + \underbrace{\beta_X \delta_{i,0} - \beta_{\mathcal{V}(X)} (1 - F_{X,i}(\Theta_X)) X_i}_{\text{vaccinations}} + \underbrace{\frac{X_{i-1}}{\tau_{X,i}} - \frac{X_i}{\tau_{X,i+1}}}_{\text{waning}}. \quad (\text{C12})$$

403 By definition, we have $X_j = 0 \forall j < 0 \wedge j > n_X + 1$, as well as $\phi_\emptyset = 0$ and $\beta_\emptyset = 0$. Furthermore, we set
 404 $\beta_S = \beta_I = \beta_Y = \beta_U = 0$ and $\phi_S = \phi_V = \phi_B = 0$, that is, there are no infections ending in vaccination
 405 compartments and no vaccinations ending in infection compartments and no transitions ending
 406 in S . Additionally, susceptibles are maximally susceptible (i.e. $e_S = 0$) and from $n_S = 0$ follows
 407 $w_S = 1$. To ensure the validity of transition terms in intermediate compartments, we additionally
 408 define $\tau_{X,j} \neq 0 \forall X, j \leq 0 \wedge j > n_X + 1$.

409 With regard to under-reporting, we assume that under-ascertainment ratios are already included
 410 in the respective rates ϕ_\bullet and β_\bullet .

Finally, the aim of this analysis is to estimate seroprevalence at time t . For each state $X_i \neq S$, we denote by $p_{X,i}$ the probability that antibodies are found in a person in state X_i . Then, the seroprevalence P of the age group/population of consideration is given as

$$P(t) = \sum_{X \neq S} \sum_{i=0}^{n_X} p_{X,i} X_i(t). \quad (\text{C13})$$

411 The model is illustrated in Fig. 9.

412 A large number of parameters are required to calibrate the model. For each state $X \in$
413 $\{I, V, Y, B, U\}$ the number of transitions n_X have to be defined, then n_X mean transition times
414 as well as $n_X + 1$ susceptibility reductions. For compartments I, V, Y and B , eligibility times Θ
415 for receiving a vaccination are to be determined. From reporting data, we obtain the daily number
416 of new infections of unvaccinated $\phi_I(t)$, vaccinated $\phi_V(t)$ and boosted $\phi_U(t)$ individuals. From
417 the vaccination archive, we obtain the daily number of completed initial vaccination series $\beta_V(t)$
418 and booster vaccinations $\beta_B(t)$. Under-reporting of infections and booster vaccinations must be
419 estimated and accounted for in the respective rates. For each state $X_i \neq S$, the probability p_{X_i} of
420 finding antibodies in a person in state X_i must also be defined.

421 All these parameters have to be determined for each of the subpopulations (age groups, re-
422 gions).

-
- 423 [1] World Health Organisation. WHO Coronavirus (COVID-19) Dashboard; 2021. Accessed: 2021-11-
424 19. Available from: <https://covid19.who.int>.
- 425 [2] Robert Koch-Institut, Fachgebiet 33. COVID-19-Impfungen in Deutschland. Zenodo; 2021. Available
426 from: <https://doi.org/10.5281/zenodo.5126652>.
- 427 [3] Vygen-Bonnet S, Koch J, Bogdan C, Harder T, Heininger U, Kling K, et al. Beschluss
428 und Wissenschaftliche Begründung der Ständigen Impfkommission (STIKO) für die COVID-19-
429 Impfeempfehlung. 2020;(2):3-63.
- 430 [4] Vygen-Bonnet S, Koch J, Armann J, Berner R, Bogdan C, Harder T, et al. Beschluss der STIKO zur 9.
431 Aktualisierung der COVID-19-Impfeempfehlung und die dazugehörige wissenschaftliche Begründung.
432 2021;(33):3-46.
- 433 [5] Vygen-Bonnet S, Koch J, Armann J, Berner R, Bogdan C, Burchard G, et al. STIKO-Empfehlung
434 zur COVID-19-Impfung von Kindern im Alter von 5–11 Jahren mit dem mRNA-Impfstoff Comirnaty
435 und die dazugehörige wissenschaftliche Begründung. 2021;(1):16-47.
- 436 [6] Ständige Impfkommission (STIKO). Beschluss der STIKO zur 10. Aktualisierung der COVID-19-
437 Impfeempfehlung. 2021;(38):3-9.
- 438 [7] Ständige Impfkommission (STIKO). Ständige Impfkommission: Beschluss der STIKO zur 18. Aktu-
439 alisierung der COVID-19-Impfeempfehlung. Epidemiologisches Bulletin. 2022;(7):3-18.

- 440 [8] Koch J, Vygen-Bonnet S, Bogdan C, Burchard G, Falman A, Garbe E, et al. Wissenschaftliche
441 Begründung der STIKO zur Aktualisierung der Empfehlung der COVID-19-Auffrischimpfung mit
442 einem mRNA-Impfstoff. 2021;(48):15-41.
- 443 [9] Vygen-Bonnet S, Koch J, Bogdan C, Burchard G, Garbe E, Heininger U, et al. STIKO-Empfehlung
444 zur COVID-19-Auffrischimpfung mit einem mRNA-Impfstoff für 12 – 17-jährige Kinder und Ju-
445 gendliche mit dem mRNA-Impfstoff Comirnaty und die dazugehörige wissenschaftliche Begründung.
446 Epidemiologisches Bulletin. 2022;(3):21-31.
- 447 [10] Neuhauser H, Buttman-Schweiger N, Ellert U, Fiebig J, Hövener C, Offergeld R, et al. Seroepi-
448 demiological studies on SARS-CoV-2 in samples from the general population and blood donors in
449 Germany – findings up to August 2021. Robert Koch-Institut, Epid Bull. 2021;37:3-12.
- 450 [11] Robert Koch Institute. Seroepidemiological Studies in Germany; 2022. Available from: [www.rki.](http://www.rki.de/covid-19-serostudies-germany)
451 [de/covid-19-serostudies-germany](http://www.rki.de/covid-19-serostudies-germany).
- 452 [12] Robert Koch Institute. Wöchentlicher Lagebericht des RKI zur Coronavirus-Krankheit-2019
453 (COVID-19) - 31.03.2022. 2022 Mar. Available from: [https://www.rki.de/DE/Content/InfAZ/
454 N/Neuartiges_Coronavirus/Situationsberichte/Wochenbericht/Wochenbericht_
455 2022-03-31.pdf?__blob=publicationFile](https://www.rki.de/DE/Content/InfAZ/N/Neuartiges_Coronavirus/Situationsberichte/Wochenbericht/Wochenbericht_2022-03-31.pdf?__blob=publicationFile).
- 456 [13] Betsch C, Korn L, Felgendreff L, Eitze S, Schmid P, Sprengholz P, et al. COSMO – Zusammenfassung
457 und Empfehlungen Wellen 52 und 53. 2021 Oct. Available from: [https://projekte.uni-erfurt.
458 de/cosmo2020/web/summary/52-53/](https://projekte.uni-erfurt.de/cosmo2020/web/summary/52-53/).
- 459 [14] Betsch C, Korn L, Felgendreff L, Eitze S, Schmid P, Sprengholz P, et al.. COVID-19 Snapshot
460 Monitoring (COSMO Germany) - Wave 52. PsychArchives; 2021. Type: dataset. Available from:
461 <https://www.psycharchives.org/handle/20.500.12034/4564>.
- 462 [15] Betsch C, Korn L, Felgendreff L, Eitze S, Schmid P, Sprengholz P, et al.. COVID-19 Snapshot
463 Monitoring (COSMO Germany) - Wave 53. PsychArchives; 2021. Type: dataset. Available from:
464 <https://www.psycharchives.org/handle/20.500.12034/4570>.
- 465 [16] Sotoodeh Ghorbani S, Taherpour N, Bayat S, Ghajari H, Mohseni P, Hashemi Nazari SS. Epidemio-
466 logic characteristics of cases with reinfection, recurrence, and hospital readmission due to COVID-19:
467 A systematic review and meta-analysis. Journal of Medical Virology. 2022 Jan;94(1):44-53. Available
468 from: <https://onlinelibrary.wiley.com/doi/10.1002/jmv.27281>.
- 469 [17] Santos-Hövener C, Neuhauser HK, Rosario AS, Busch M, Schlaud M, Hoffmann R, et al. Serology-
470 and PCR-based cumulative incidence of SARS-CoV-2 infection in adults in a successfully contained

- 471 early hotspot (CoMoLo study), Germany, May to June 2020. *Euro Surveillance: Bulletin Européen*
472 *Sur Les Maladies Transmissibles = European Communicable Disease Bulletin*. 2020 Nov;25(47).
- 473 [18] Neuhauser H, Rosario AS, Butschalowsky H, Haller S, Hoebel J, Michel J, et al. Germany's low
474 SARS-CoV-2 seroprevalence confirms effective containment in 2020: Results of the nationwide RKI-
475 SOEP study. *medRxiv*. 2021. Available from: [https://www.medrxiv.org/content/early/](https://www.medrxiv.org/content/early/2021/11/24/2021.11.22.21266711)
476 [2021/11/24/2021.11.22.21266711](https://www.medrxiv.org/content/early/2021/11/24/2021.11.22.21266711).
- 477 [19] Feikin DR, Higdon MM, Abu-Raddad LJ, Andrews N, Araos R, Goldberg Y, et al. Duration of
478 effectiveness of vaccines against SARS-CoV-2 infection and COVID-19 disease: results of a sys-
479 tematic review and meta-regression. *The Lancet*. 2022 Mar;399(10328):924-44. Available from:
480 <https://linkinghub.elsevier.com/retrieve/pii/S0140673622001520>.
- 481 [20] Krueger T, Gogolewski K, Bodych M, Gambin A, Giordano G, Cuschieri S, et al. Risk assess-
482 ment of COVID-19 epidemic resurgence in relation to SARS-CoV-2 variants and vaccination passes.
483 *Communications Medicine*. 2022 Mar;2(1):23. Available from: [https://doi.org/10.1038/](https://doi.org/10.1038/s43856-022-00084-w)
484 [s43856-022-00084-w](https://doi.org/10.1038/s43856-022-00084-w).
- 485 [21] Verity R, Okell LC, Dorigatti I, Winskill P, Whittaker C, Imai N, et al. Estimates of the severity of coro-
486 navirus disease 2019: a model-based analysis. *The Lancet Infectious Diseases*. 2020 Jun;20(6):669-
487 77. Available from: [https://doi.org/10.1016/S1473-3099\(20\)30243-7](https://doi.org/10.1016/S1473-3099(20)30243-7).
- 488 [22] Berger U, Fritz C, Kauermann G. Eine statistische Analyse des Effekts von verpflichtenden Tests
489 an Schulen mit Präsenzunterricht im Vergleich zum Distanzunterricht. 2021;238. Available from:
490 <https://epub.ub.uni-muenchen.de/76005/>.
- 491 [23] Iyer AS, Jones FK, Nodoushani A, Kelly M, Becker M, Slater D, et al. Persistence and decay of
492 human antibody responses to the receptor binding domain of SARS-CoV-2 spike protein in COVID-
493 19 patients. *Science Immunology*. 2020;5(52):eabe0367. Available from: [https://www.science.](https://www.science.org/doi/abs/10.1126/sciimmunol.abe0367)
494 [org/doi/abs/10.1126/sciimmunol.abe0367](https://www.science.org/doi/abs/10.1126/sciimmunol.abe0367).
- 495 [24] Office for National Statistics (ONS) - UK. Coronavirus (COVID-19) Infec-
496 tion Survey Technical Article: Impact of vaccination of testing positive in
497 the UK: October 2021. 2021. Available from: [https://www.ons.gov.uk/](https://www.ons.gov.uk/peoplepopulationandcommunity/healthandsocialcare/conditionsanddiseases/articles/coronaviruscovid19infectionsurveytechnicalarticleimpactofvaccinationontestingpositive/october2021)
498 [peoplepopulationandcommunity/healthandsocialcare/conditionsanddiseases/](https://www.ons.gov.uk/peoplepopulationandcommunity/healthandsocialcare/conditionsanddiseases/articles/coronaviruscovid19infectionsurveytechnicalarticleimpactofvaccinationontestingpositive/october2021)
499 [articles/coronaviruscovid19infectionsurveytechnicalarticleimpactofvaccinationontestingposi](https://www.ons.gov.uk/peoplepopulationandcommunity/healthandsocialcare/conditionsanddiseases/articles/coronaviruscovid19infectionsurveytechnicalarticleimpactofvaccinationontestingpositive/october2021)
500 [october2021](https://www.ons.gov.uk/peoplepopulationandcommunity/healthandsocialcare/conditionsanddiseases/articles/coronaviruscovid19infectionsurveytechnicalarticleimpactofvaccinationontestingpositive/october2021).
- 501 [25] Faensen, D and Krause, G. *SurvStat@RKI – a web-based solution to query surveillance data in*

- 502 Germany. Weekly releases (1997–2007) Euro Surveill. 2004;8(22). Available from: <https://www.eurosurveillance.org/content/10.2807/esw.08.22.02477-en>.
- 503
- 504 [26] Robert Koch-Institut. SARS-CoV-2 Sequenzdaten aus Deutschland. Zenodo; 2022. Available from:
- 505 <https://doi.org/10.5281/zenodo.6381314>.
- 506 [27] Statistisches Bundesamt (Destatis). GENESIS-Tabelle: 12411-0012, Bevölkerung: Bundesländer, Stichtag, Altersjahre. Statistisches Bundesamt (Destatis); 2020. Available from:
- 507 [https://www-genesis.destatis.de/genesis/online?sequenz=statistikTabellen&](https://www-genesis.destatis.de/genesis/online?sequenz=statistikTabellen&selectionname=12411#abreadcrumb)
- 508 [selectionname=12411#abreadcrumb](https://www-genesis.destatis.de/genesis/online?sequenz=statistikTabellen&selectionname=12411#abreadcrumb).
- 509
- 510 [28] Barek MA, Aziz MA, Islam MS. Impact of age, sex, comorbidities and clinical symptoms on
- 511 the severity of COVID-19 cases: A meta-analysis with 55 studies and 10014 cases. Heliyon.
- 512 2020;6(12):e05684. Available from: [https://www.sciencedirect.com/science/article/](https://www.sciencedirect.com/science/article/pii/S2405844020325275)
- 513 [pii/S2405844020325275](https://www.sciencedirect.com/science/article/pii/S2405844020325275).
- 514 [29] Brinkmann F, Diebner HH, Matenar C, Schlegtendal A, Spiecker J, Eitner L, et al. Longitudinal
- 515 Rise in Seroprevalence of SARS-CoV-2 Infections in Children in Western Germany—A Blind Spot in
- 516 Epidemiology? Infect Dis Rep. 2021 Nov;13:957–964.
- 517 [30] Hippich M, Holthaus L, Assfalg R, Zapardiel-Gonzalo J, Kapfelsperger H, Heigermoser M, et al.
- 518 A Public Health Antibody Screening Indicates a 6-Fold Higher SARS-CoV-2 Exposure Rate than
- 519 Reported Cases in Children. Med (NY). 2021 Feb;2:149–163.
- 520 [31] Wachter F, Regensburger AP, Peter AS, Knieling F, Wagner AL, Simon D, et al. Continuous
- 521 monitoring of SARS-CoV-2 seroprevalence in children using residual blood samples from routine
- 522 clinical chemistry. Clinical Chemistry and Laboratory Medicine (CCLM). 2022. Available from:
- 523 <https://doi.org/10.1515/cc1m-2022-0037>.
- 524 [32] Morens DM, Folkers GK, Fauci AS. The Concept of Classical Herd Immunity May Not Apply to
- 525 COVID-19. The Journal of Infectious Diseases. 2022 Mar. Available from: [https://doi.org/10.](https://doi.org/10.1093/infdis/jiac109)
- 526 [1093/infdis/jiac109](https://doi.org/10.1093/infdis/jiac109).
- 527 [33] Hall V, Foulkes S, Insalata F, Kirwan P, Saei A, Atti A, et al. Protection against SARS-CoV-
- 528 2 after Covid-19 Vaccination and Previous Infection. New England Journal of Medicine. 2022
- 529 Mar;386(13):1207–20. Available from: <http://www.nejm.org/doi/10.1056/NEJMoa2118691>.
- 530 [34] Altarawneh HN, Chemaitelly H, Ayoub H, Tang P, Hasan MR, Yassine HM, et al. Effect of prior
- 531 infection, vaccination, and hybrid immunity against symptomatic BA.1 and BA.2 Omicron infections
- 532 and severe COVID-19 in Qatar. Epidemiology; 2022. Available from: <http://medrxiv.org/>

- 533 lookup/doi/10.1101/2022.03.22.22272745.
- 534 [35] Quandt J, Muik A, Salisch N, Lui BG, Lutz S, Krüger K, et al. Omicron breakthrough infection
535 drives cross-variant neutralization and memory B cell formation. *Immunology*; 2022. Available from:
536 <http://biorxiv.org/lookup/doi/10.1101/2022.04.01.486695>.
- 537 [36] Robert Koch-Institut. SARS-CoV-2 Infektionen in Deutschland. Zenodo; 2022. Available from:
538 <https://doi.org/10.5281/zenodo.5989727>.
- 539 [37] Robert Koch-Institut. Wöchentlicher Lagebericht des RKI zur Coronavirus-Krankheit-2019 (COVID-
540 19). 2021 dec. Available from: [https://www.rki.de/DE/Content/InfAZ/N/Neuartiges_](https://www.rki.de/DE/Content/InfAZ/N/Neuartiges_Coronavirus/Situationsberichte/Wochenbericht/Wochenbericht_2021-12-23.pdf?__blob=publicationFile)
541 [Coronavirus/Situationsberichte/Wochenbericht/Wochenbericht_2021-12-23.pdf?__](https://www.rki.de/DE/Content/InfAZ/N/Neuartiges_Coronavirus/Situationsberichte/Wochenbericht/Wochenbericht_2021-12-23.pdf?__blob=publicationFile)
542 blob=publicationFile.
- 543 [38] Autorengruppe Corona-KiTa-Studie (2021). Quartalsbericht der Corona-KiTa-Studie 6. Quar-
544 talsbericht (IV/2021). DJI. 2021. Available from: [https://corona-kita-studie.de/](https://corona-kita-studie.de/quartalsberichte-der-corona-kita-studie)
545 quartalsberichte-der-corona-kita-studie.
- 546 [39] Maier B. serocov: Estimating the distribution of COVID-19-susceptible, -recovered, and -vaccinated
547 individuals in Germany up to April 2022. Zenodo; 2022. Available from: [https://doi.org/10.](https://doi.org/10.5281/zenodo.6470799)
548 5281/zenodo.6470799.