

# The risk of SARS-CoV-2 transmission in the healthcare setting and potential impact of cohorting strategies

Joel C. Miller<sup>1\*</sup>, Xueting Qiu<sup>2</sup>, William P. Hanage<sup>2</sup>

**1** School of Engineering at Mathematical Sciences, La Trobe University, Bundoora, VIC

**2** Center for Communicable Disease Dynamics, Department of Epidemiology, T.H. Chan School of Public Health, Harvard University, Boston MA, USA

\* joel.c.miller@gmail.com

## Abstract

The threat of the COVID-19 pandemic of SARS-CoV-2 virus has grown since its start late last year. A customary response to a surge of a communicable disease is to separate healthcare systems into cohorts, such that patients with other conditions can be treated safely without risk of infection. A challenge with COVID-19 is the existence of currently asymptomatic infections, which without aggressive testing and isolation might enter the non-COVID-19 cohort either through unknowingly infected patients or health care workers. Using stochastic simulations we study the impacts of testing and personal protective equipment (PPE) use. In the base case without testing or PPE, healthcare is rapidly overwhelmed, and becomes a net contributor to the force of infection. We find that effective use of PPE by both HCW and patients can prevent this situation, while testing alone is less effective. We also find that even imperfectly effective use of PPE can provide substantial protection and decrease the force of infection. This illustrates the importance of maintaining supplies of PPE throughout healthcare systems.

## 1 Introduction

The pandemic of COVID-19 disease caused by SARS-CoV-2 is the most serious threat in over a century to global healthcare. The global totals of infected individuals are in the exponential growth phase, with some regions more affected than others as we write. While comparatively extreme interventions in China, where the pandemic started in 2019, have apparently successfully brought transmission under control [17], other locations have yet to achieve this, and may not be able to given local conditions. Even in those regions that have successfully eliminated the pandemic, for now, there remains the risk of re-introduction.

Early reports from Wuhan indicated a relatively large proportion of cases among health care workers, who have also been disproportionately represented in confirmed cases from

both Italy and the US [11, 2, 20]. Not only is this a major concern for the health of people on the front line of pandemic response, there is also a risk of transmission to patients. For this reason, the design of cohorting strategies to restrict contact between COVID-19 patients and the rest of the healthcare system are of great importance. Already in some locations, hospitals or other facilities are being exclusively dedicated for COVID-19 patients, separate from others for the non-COVID-19 cohort, and alternate care facilities are in the process of being established [1]. China built entirely new healthcare facilities to handle the surge in Wuhan [3, 17].

While presently the focus is rightly on the initial surge of COVID-19 disease in the portion of healthcare which is handling it, we lack a secure framework in which to interpret the risk and the consequences of nosocomial infection in the part of healthcare that is separate from the treatment of known COVID-19 infections.

In this paper we investigate results from a stochastic system to model introductions into the non-COVID-19 cohort in the healthcare system, assuming that the background dynamics in the community at large follow simple deterministic  $SEI_A I_1 I_2 R$  dynamics. Individuals begin susceptible ( $S$ ). Following a transmission event, they move into the exposed class ( $E$ ). After that they become infectious. A fraction of these remain asymptomatic ( $I_A$ ) and so can only be identified through testing. Another fraction of infections are initially “pre-symptomatic” ( $I_1$ ) and eventually exhibit symptoms ( $I_2$ ) which could lead to identification. Finally they recover with immunity ( $R$ ).

We assume a cohorting strategy in which the population is divided into the general public and a cohort of Health Care Workers (HCWs) and patients which are kept separate from individuals diagnosed with COVID-19. In practice it may make sense for a community to divide their uninfected patients and HCWs into multiple subcohorts which are intended to contain the impact of an introduction. The dynamics of health care workers and the uninfected patients are stochastic. Within the non-COVID-19 cohort, we assume that once individuals become symptomatic they are identified and removed. We use stochastic simulations to track these components. We assume that the background dynamics follow simple deterministic  $SEI_A I_1 I_2 R$  dynamics. To demonstrate the impacts of control measures and cohort size, we focus on a single cohort of HCWs and the patients.

## 2 Methods

We consider a basic transmission model. The model has two major components: transmission within the broader community, and transmission within a cohort of HCWs and patients who are initially not infected with SARS-CoV-2, that is, the non-COVID-19 cohort.

The specific details of our simulations are described in the Appendix. The simulations are scripted in Python (scripts can be found here – <https://github.com/joelmiller/HospitalCOVID19>). What follows is a broad overview of the model structure. We assume that the broader community follows deterministic dynamics, described by a system of ordinary differential equations.

The HCWs and patient cohort is modelled stochastically using a Gillespie-Doob algorithm

Variable	Definition
$S, E, I_A, I_1, I_2, R$	number of susceptible, exposed, asymptomatic infectious, presymptomatic infectious, symptomatic infectious, and recovered individuals in the general population.
$S_P, E_P, I_{A,P}, I_{1,P}, R_P$	number of patients in the cohort. We assume that symptomatic cases are removed immediately.
$S_H, E_H, I_{A,H}, I_{1,H}, Q_H, R_H$	number of HCWs of each status. We assume that identified infections are moved into a quarantine class $Q_H$ until recovering.
$N_P = S_P + E_P + I_{A,P} + I_{1,P} + R_P$ and $N_H = S_H + E_H + I_{A,H} + I_{1,H} + R_H$	Number of patients and health care workers active in the cohort (no symptomatic or quarantined individuals).

Table 1: The variables used in the model. The  $I_{2,P}$ ,  $I_{2,H}$  classes are neglected in the model because we assume individuals are removed as soon as they become symptomatic.

[21]. The cohort experiences introductions either through HCWs infected in the broader community or patients (which may come from visitors to the hospital or from newly admitted patients who are incorrectly identified as uninfected).

## 2.1 Variables and Parameters

We will use the variables  $S$ ,  $E$ ,  $I_A$ ,  $I_1$ ,  $I_2$ , and  $R$  for two purposes: both to denote the number of individuals in a particular state, and also as a shorthand to refer to the status of an individual. So the number of  $S$  individuals in the population is  $S$ , and the number of  $E$  HCWs in the cohort is  $E_H$ .

Table 1 shows the variables we track with the models, and Tables 2 and 3 show the parameters and their default values.

The basic reproduction number in the general population is

$$\mathcal{R}_0 = (1 - q) \left( \frac{\lambda_1}{\gamma_{I,1}} + \frac{\lambda_2}{\gamma_{I,2}} \right) + q \frac{\lambda_A}{\gamma_A}$$

For our values, we find  $\mathcal{R}_0 = 2.5 - 0.25q$ . If all individuals become symptomatic ( $q = 0$ ) then  $\mathcal{R}_0 = 2.5$ , while if all become asymptomatic ( $q = 1$ ) then  $\mathcal{R}_0 = 2.25$ . The  $\mathcal{R}_0$  value is in the range of estimations from previous studies [18, 23, 24]. We assume that the average transmission rate in asymptomatic infection is the same as that in pre-symptomatic infection, that is,  $\lambda_A = \lambda_1$ .

Within the hospital, we expect that HCWs are at high risk of infection, even if they have personal protective equipment (PPE). This is because of the frequent close interactions between HCWs and their patients. Additionally this expectation is supported by the observed

Parameter	Default Value	Definition
$\lambda_1$	1/4	Average transmission rate from $I_1$ individuals
$\lambda_2$	2/7	Average transmission rate from $I_2$ individuals
$\lambda_A$	$\lambda_1$	Average transmission rate from $I_A$ individuals
$\lambda$	$\lambda_1 I_1 + \lambda_2 I_2 + \lambda_A I_A$	Overall transmission rate (force of infection) to $S$ individuals in general public.
$\gamma_E$	1/3	rate of a transition out of $E$ to either $I_1$ or $I_A$ .
$q$	1/2	The probability a transition from $E$ is to $I_A$ .
$\gamma_{I,1}$	1/2	rate of an $I_1 \rightarrow I_2$ transition.
$\gamma_{I,2}$	1/7	rate of an $I_2 \rightarrow R$ transition.
$\gamma_A$	1/9	The rate of an $I_A \rightarrow R$ transition.

Table 2: Default parameter values of disease spread in general population

high rates of infection among HCWs in many different populations [17, 19, 6, 2]. This is reflected in the large value of  $C_{PH}$ , representing that an infected patient transmits to HCWs at a rate that is  $C_{PH}$  times that of a general member of the public to other members of the public.

We anticipate that HCWs to patients transmission rates will also be high. HCWs transmit to patients at a rate that is  $C_{HP}$  times that of a general member of the public to other members of the public. It should be noted that patients typically outnumber HCWs. So the transmissions from patients to HCWs are concentrated in a smaller population. This means that all else being equal, the force of infection experienced by HCWs is higher than that of patients. So even if  $C_{PH} = C_{HP}$ , this represents a higher transmission probability per interaction from patients to HCWs than *vice versa*.

## 3 Analysis

### 3.1 Basic outcomes

We find that in the absence of any attempts to prevent introduction of SARS-CoV-2 to the non-COVID-19 cohort, HCWs rapidly become infected early on in the epidemic (Figure 1(a)), consistent with general observations from the early stages of the pandemic [10, 17]. While this leads to a high force of infection to patients in the early stage of the epidemic (Figure 1(a)), later, once many of the HCWs have developed immunity or become symptomatic and moved into quarantine, the force of infection to patients drops. At later stages, as the epidemic grows in the general population, the patients are at reduced risk. This is because the patients primarily interact with HCWs who have been immunized by infection, meanwhile they have relatively little interaction with other patients or the general public.

Parameter	Default Value	Definition
$\gamma_Q$	1/14	The rate at which quarantined individuals are released.
$\omega$	0	Testing rate of HCWs and Patients. Increased testing means $\omega=0.05$ .
$\rho$	0	Probability a non-symptomatic individual would get admitted.
$C_H$	0.1	The relative transmission from the general public to HCWs.
$C_P$	0.1	The relative transmission from the general public to patients (captures risk from hospital visitors).
$C_{PP}$	0.5	Scaling factor for patient to patient transmissions relative to number expected an infected individual would cause in general population.
$C_{PH}$	2	Scaling factor for patient to HCW transmission, relative to general population
$C_{HP}$	2	Scaling factor for HCW to patient transmission.
$C_{HH}$	1	Scaling factor for HCW–HCW transmission within the cohort.
$\hat{N}$	1000	the typical size of a cohort in absence of transmission. The natural discharge rate is $b/\hat{N}$ . In absence of disease $N_P$ would oscillate around $\hat{N}$ .
$\hat{N}/4$	250	The total number of HCWs allocated to the cohort (changes when HCWs go into or return from quarantine).
$b$	$\hat{N}/14$	natural rate at which new patients arrive at a cohort.

Table 3: The default values for health-care related parameters.

### 3.2 Impacts of regular testing

Testing is important in order to enact sound containment measures. HCWs have been recognized as an important groups to receive testing both because of the exposure risks inherent in their profession and the potential consequences of their infection [1]. In absence of testing, the asymptomatic patients and HCWs cannot be removed from the population and pose an infection risk to the rest of the cohort. When we set the testing rate of patients and HCWs at  $\omega = 0.05$ , we see a significantly lower force of infection (FOI) on both HCWs and patients (Figure 1(b)). It takes longer for the HCWs to all become infected, and the peak level of HCW quarantine is higher as a result of more cases being identified.

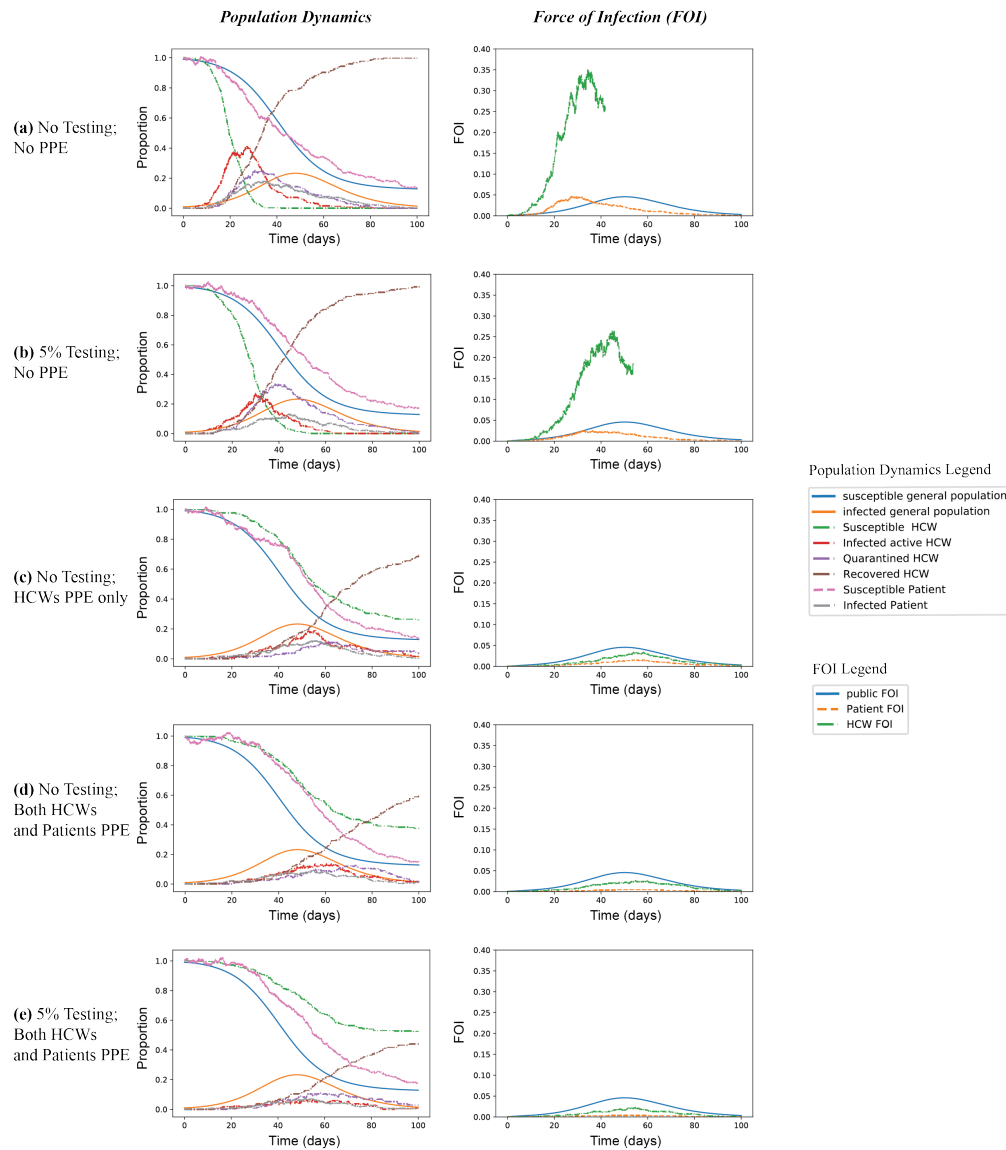

Figure 1: Comparing different scenarios of testing and PPE. Plots are showing the susceptible and infected portions of the cohort, and the force of infection. When there is no testing and no PPE (a), all HCWs are infected quite early on. The calculation of FOI on HCWs terminates once all have been infected. At peak about 40% of the HCWs are infected (not in quarantine), and shortly thereafter about 20% of the HCWs are under quarantine. The plots show that both testing (b) and PPE (c-d) can reduce the force of infection (FOI). But PPE has more substantial impacts on delaying and reducing the HCWs infection peak and the FOI. Noticeably, even only HCWs have PPE on (c), the infection peak and FOI in both HCWs and patients are reduced. (e) is showing the impact of simultaneously having both testing and PPE.

### 3.3 Impacts of PPE

PPE can provide substantial impacts on delaying the infection peak and reducing FOI, even only being used in HCWs (Figure 1(c), (d), (e)). Then to explore the impacts under different quality of PPE, we define perfect PPE can bring down inside hospital transmission to the general population level; Imperfect PPE is defined by reduced effectiveness of PPE in preventing transmission, and can be considered to represent situations in which PPE shortages lead to diversion of supply to the COVID-19 cohort. For example, 50% effective PPE means that the use of PPE can bring down half of the transmissions inside the hospital. Based on the simulations (Figure 2), we find that even half effective PPE (Figure 2(b)) can bring down the FOI of HCWs near to that in the general population.

### 3.4 Impacts of asymptomatic infection

Due to the uncertainty on the proportion of asymptomatic infections (18%-75%) from epidemiological studies [15, 9, 16, 4], we examined scenarios in which varying proportions of infections were asymptomatic ( $q$ ), in the presence of testing to detect them at rate  $\omega = 0.05$  (Figure 3). As shown, an increasing proportion of asymptomatic infections impacts upon the FOI among the HCWs, making it peak earlier with concomitant effects on patients (Figure 3(a-c)). But the effect of this is minor in comparison with the consequences of reducing the duration of the asymptomatic period (Figure 3(d)), which intuitively reduces the opportunity for exposure and transmission. This reflects the importance of testing for detecting infected individuals among both HCWs and patients promptly. It also indicates the importance of PPE use among as many individuals as possible, in order to limit unwitting transmission from individuals not yet tested.

### 3.5 Impacts of cohort size

The probability a cohort of size  $L$  is not invaded by infection is  $e^{-kL}$  for some  $k > 0$ . The value of  $k$  increases with the rate at which non-symptomatic infected individuals are admitted, the rate at which the general public transmits to patients or HCWs, and the transmission rate between individuals in the health-care system. The value of  $k$  decreases as the recovery rates and testing rates increase.

The probability that a given introduction establishes in a cohort is independent of  $L$  once  $L$  is reasonably large. However, the expected number of introductions is proportional to  $L$ . For this reason, the probability a cohort does not have a successful introduction increases as  $L$  decreases. The probability of at least one successful introduction into a cohort is  $1 - e^{-kL}$ .

If infection is established within a cohort, it will typically infect some fraction of the total population. Like typical epidemics, this fraction is independent of the population size. So for larger populations, the number of infections increases.

This motivates the following observation: given a collection of cohorts that are small enough to each have a non-negligible chance of escaping infection, then joining them together increases the risk to all members of the cohorts. The cumulative distribution function of

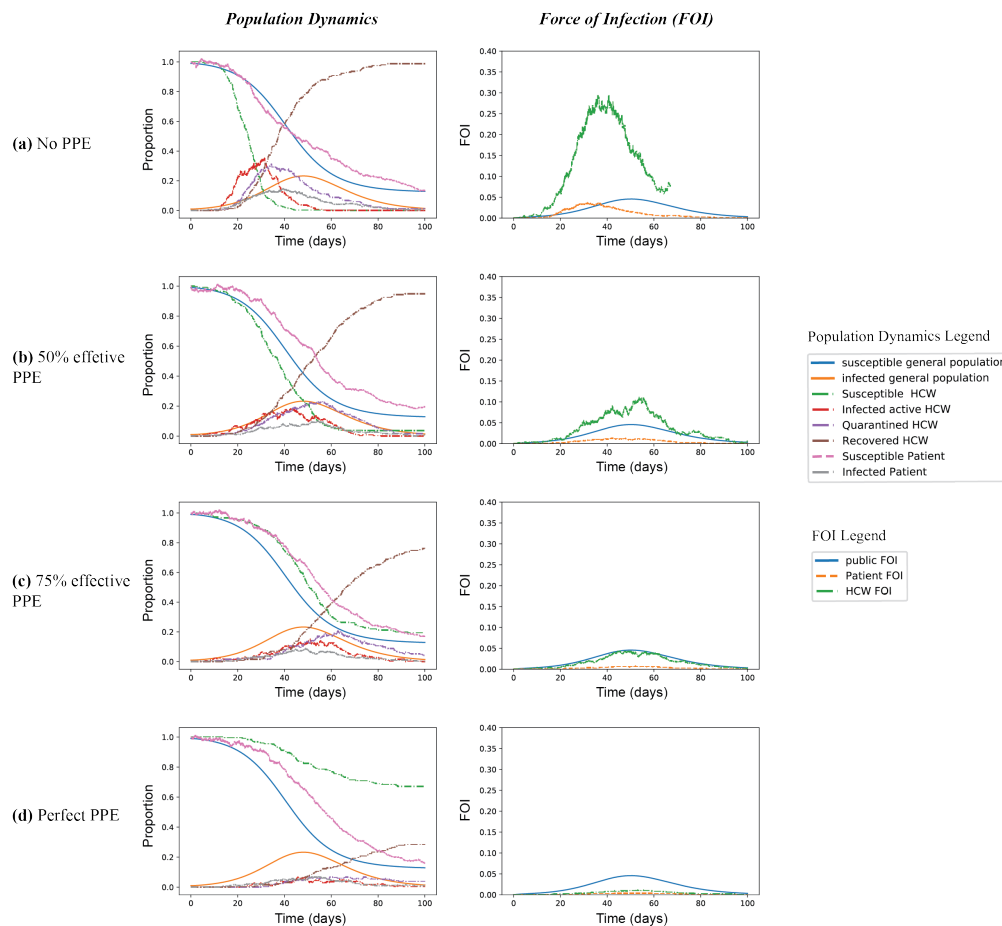

Figure 2: The relative protection of PPE in non-COVID-19 cohorts. Here the scenarios are always with testing rate  $\omega=0.05$  but with different quality of PPE. Perfect PPE is defined as PPE can bring down inside hospital transmission to the general population level transmission (d); Imperfect PPE defined by reducing the percentage of the relative transmissions, where plot (a) represents no PPE is used; (b) represents the PPE can reduce half of the transmissions inside the hospital; (c) represents the PPE can reduce 75% of transmissions inside the hospital. Results indicate that even imperfect PPE used in non-COVID-19 cohorts can lower the peaks of internal infection and reduce the force of infection inside the hospital.

outbreak sizes for cohorts of different size is shown in Figure 4. This suggests that having smaller cohorts and making efforts to minimize the risk of successful introduction can be an effective way to reduce risk of infection within the cohorts. Smaller cohorts also reduce the amount of additional testing required to identify secondary transmission among contacts once one case is identified.

Whether infection comes in through an externally infected HCW, a visitor, or an asymptomatic new infection does not significantly affect the outcomes. As long as the within cohort reproduction number (Appendix B) is greater than 1, once the infection is established in the cohort the dynamics will be dominated by the internal infection process.



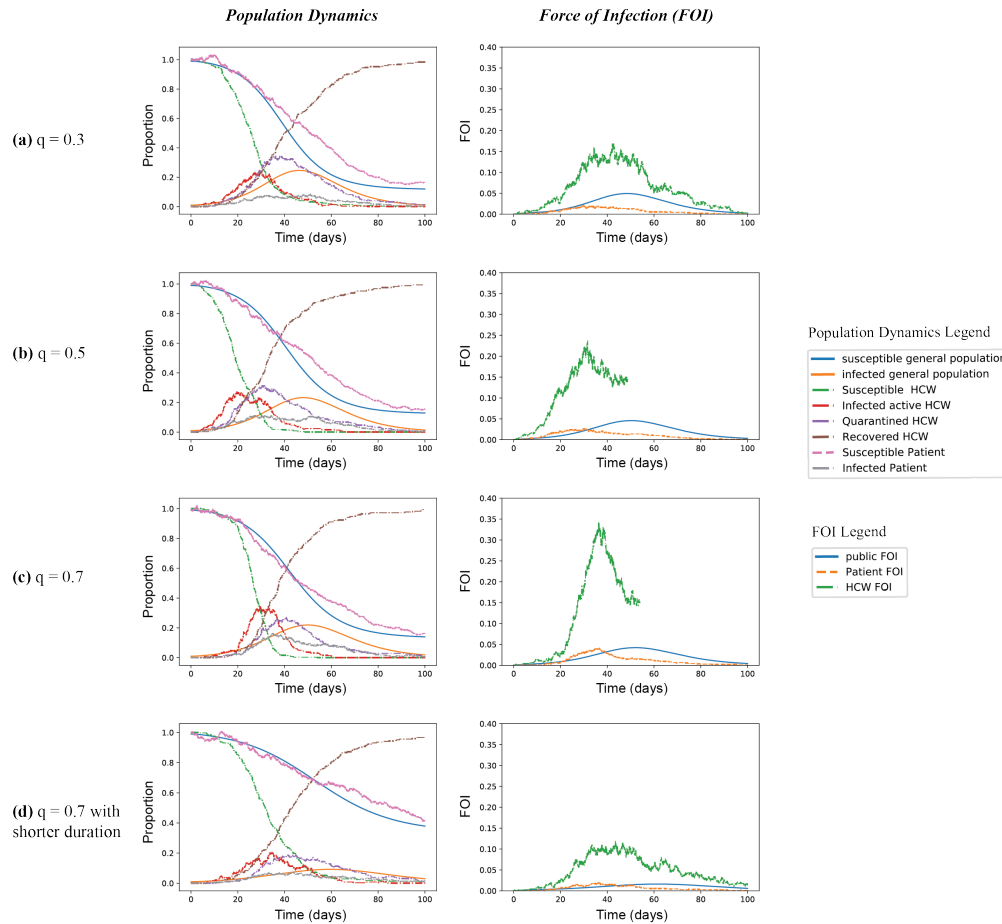

Figure 3: Comparison of scenarios with varying proportions of asymptomatic infections ( $q$ ). Here all scenarios have a testing rate  $\omega=0.05$ . The proportion was changed from the default value of  $q=0.5$  in (b) to a lower value of  $q=0.3$  in (a) and then to a higher value of  $q=0.7$  in (c). To explore the impact of potential shorter duration of infectiousness of asymptomatic infections, the parameter of  $\gamma_A$  was changed from the default  $1/9$  to  $1/5$  with  $q=0.7$  in (d). We find that the increasing proportions of asymptomatic infections can increase the peak of infected HCWs and patients, increase, the FOI, and reduce the peak of quarantined HCWs. However, the duration of infectiousness of the asymptomatic has larger impacts, where under the higher proportion  $q=0.7$ , if the duration of infectiousness is shorter, the peak of infections and FOI can substantially reduce.

## 4 Discussion

COVID-19 presents a special challenge for healthcare systems. The pronounced increases in the risk of severe disease or death that are found in older age groups, as well as patients suffering co-morbidities, demands that these at-risk groups be protected. And yet they are also disproportionately likely to require healthcare for conditions other than COVID-19. Contact and risk to the vulnerable can be reduced by innovations such as telemedicine

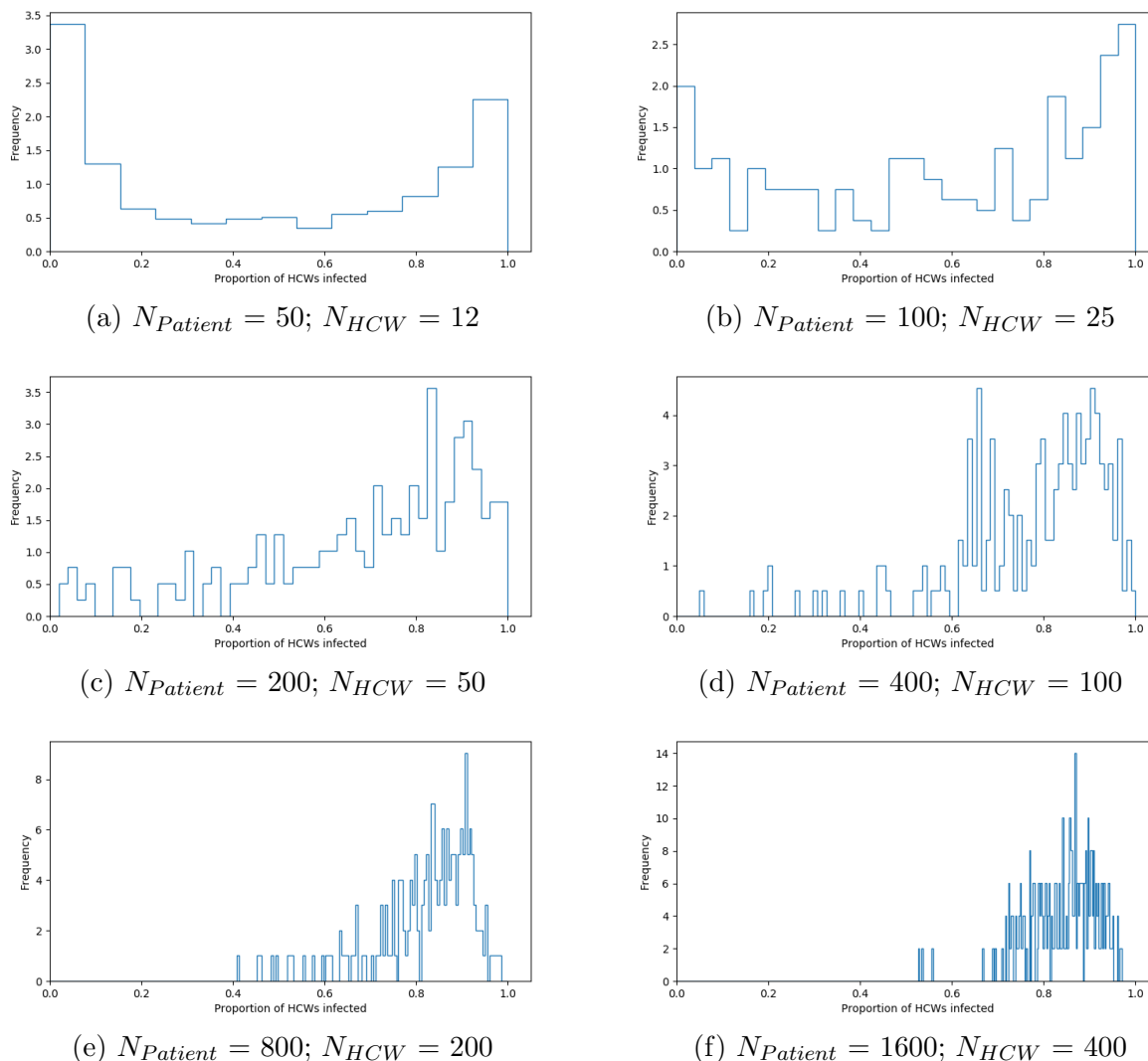

Figure 4: The impacts of cohort size, based on 200 simulations per cohort size. Probability density of outbreak sizes for different cohort sizes. As the cohort size increases the frequency of small outbreaks goes down. With large cohort sizes, all cohorts have outbreaks that infect a large fraction of people. With small cohort sizes, many cohorts have no outbreaks, or outbreaks that only infect a few.

consultations for chronic conditions, but urgent care will remain to be needed in acute cases. This work has been an attempt to define the roles of cohorting, prompt and accurate diagnostic testing and PPE in protecting those patients who need urgent care for conditions other than COVID-19, and the HCWs who look after them.

Our primary finding is that the relative impacts of interventions depend on the underlying properties of the disease and in particular infection from currently asymptomatic individuals. The possibility of this has been apparent for some time and it has recently been confirmed

to be responsible for a large fraction of transmission events [7]. We find that this makes little impact on the force of infection (with the caveat that it depends on the duration of the asymptomatic period), but it magnifies the impact of effective PPE. The potential for transmission from pre-symptomatic individuals has long been known to be a crucial component in how hard we expect it to be to control an infection [5]. This model shows that if we wish to prevent SARS-CoV-2 transmission among the vulnerable non-covid cohort it is helpful to assume that all individuals may be infectious, both staff and patients, and act accordingly. This is increasingly understood and in well resourced locations where masks are widely available they are often being used throughout healthcare. However this may not continue to be the case given shortages, and PPE for the non-COVID-19 cohort is an important element of planning.

Our findings regarding the size of sub cohorts are somewhat nuanced, but identifying some general trends is straightforward; reducing any of the transmission rates is unsurprisingly important in reducing transmission. However by keeping the cohort smaller, we reduce the probability that infection establishes in the cohort. Further, by reducing interaction amongst HCWs, we can reduce transmission risks.

If infection reaches a cohort, the introduction may fail to establish itself. However, modeling shows that when an infection does establish it tends to have an increased early growth rate [14]. Mathematically this can be interpreted as a consequence of the fact that if on average a small outbreak would grow by a factor of  $\mathcal{R}_0$  at each generation, but some go extinct, then those that do not go extinct must have increased transmissibility in order to achieve the observed dynamics [12]. This means that interventions that increase the probability of causing 0 transmissions from an introduction are of particular importance. In the presence of a very high force of infection from the community at large they are of limited value. However in combination with a sustained effort to prevent the introduction of infections (and at the initial stage of the pandemic) smaller cohorts in which HCW are kept separate may have value in preventing establishment of the infection in the healthcare setting.

There are several important elements of the COVID-19 pandemic and SARS-CoV-2 biology that are not captured by our model. We have assumed an unmitigated outbreak outside the non-COVID-19 cohort, which is not the case in most locations. However much of the the most important dynamics we observe happen early on, and so our findings will be relevant independent of the details of the pandemic outside. We also do not directly model the consequences of transmission in the health care setting; obviously transmission to elderly patients or otherwise vulnerable individuals is expected to have an outsize impact on overall mortality and the strain on healthcare in general. We have also not considered the consequences of an overdistributed  $R_0$ . The SARS-CoV-1 outbreak, as well as MERS outbreaks have both been characterised by superspreading events in healthcare settings [8, 22], and future work should explicitly consider the impact of these. This is especially relevant to our findings on the size of individual subcohorts, because it is known that an overdispersed  $R_0$  can lead to situations in which most disease introductions go extinct, but those that do not go on to cause explosive outbreaks [12].

In reality we might wish to distinguish between truly asymptomatic and presymptomatic cases and those in which the presentation of disease is unusual and so the infection is not suspected. The overall impact however is similar for our model. We have not modeled the potential for transmission to be further curtailed by aggressive isolation of contacts of known cases, either among patients or HCWs. We have also not modeled the impact of strategies in the community to limit transmission and infection, such as physical distancing or salutary sheltering, instead assuming a simple and symmetrical force of infection. These are not likely to alter our major conclusions.

As communities around the globe confront the pandemic, they should be careful to ensure that there is adequate supply of PPE throughout healthcare. Testing must be made available both to identify those who are infected and those who have been infected, and innovative approaches will need to be taken to minimize the pandemic threat. We do not expect that these conclusions will be surprising to many, but the failure to act upon them so far is also a source of dismay to many. We hope that our analysis will motivate future action to preserve lives.

## A Model description

### A.1 Dynamics in general public

We assume that the infection status of individuals in the general public can be separated into 6 classes: Individuals begin Susceptible ( $S$ ). After receiving a transmission, they become Exposed ( $E$ ) but not infectious. They then become Infectious but not symptomatic (presymptomatic infectious)  $I_1$ , Infectious and symptomatic  $I_2$ , and recovered  $R$  (Figure 5). There is considerable dispute about the distinction between truly asymptomatic infection, presymptomatic or subclinical and so on. Here we use this term to capture those who could not be reasonably expected to alter their behavior to avoid infecting others.

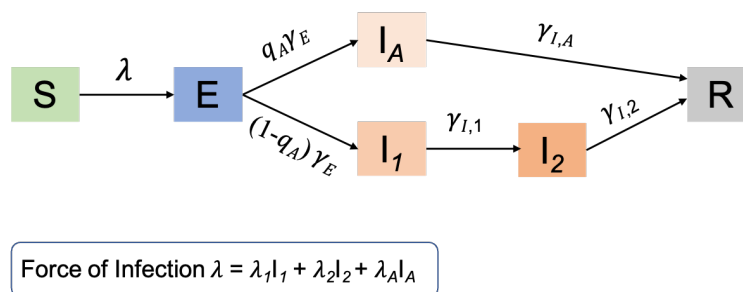

Figure 5: Compartmental model of the dynamics in general public

We assume deterministic dynamics in the general population as, at least initially, we expect the epidemic to be more advanced and the incidence to be higher outside the healthcare

setting. We have

$$\begin{aligned}
 S' &= -\lambda \frac{S}{N} \\
 E' &= \lambda \frac{S}{N} - \gamma_E E \\
 I'_A &= q_A \gamma_E E - \gamma_{I,A} I_A \\
 I'_1 &= (1 - q_A) \gamma_E E - \gamma_{I,1} I_1 \\
 I'_2 &= \gamma_{I,1} I_1 - \gamma_{I,2} I_2 \\
 R' &= \gamma_{I,2} I_2 + \gamma_{I,A} I_A
 \end{aligned}$$

where  $\lambda = \lambda_1 I_1 + \lambda_2 I_2 + \lambda_A I_A$ .

## A.2 Dynamics in cohort of (presumed) uninfected patients

We now derive the equations which will be used in patients. These will calculate the rates at which transitions happen.

We assume if a patient becomes symptomatic or is identified as infected through testing, the patient is immediately removed from the cohort, so we track  $S_P$ ,  $E_P$ ,  $I_A$ , and  $I_{1,P}$  (Figure 6).

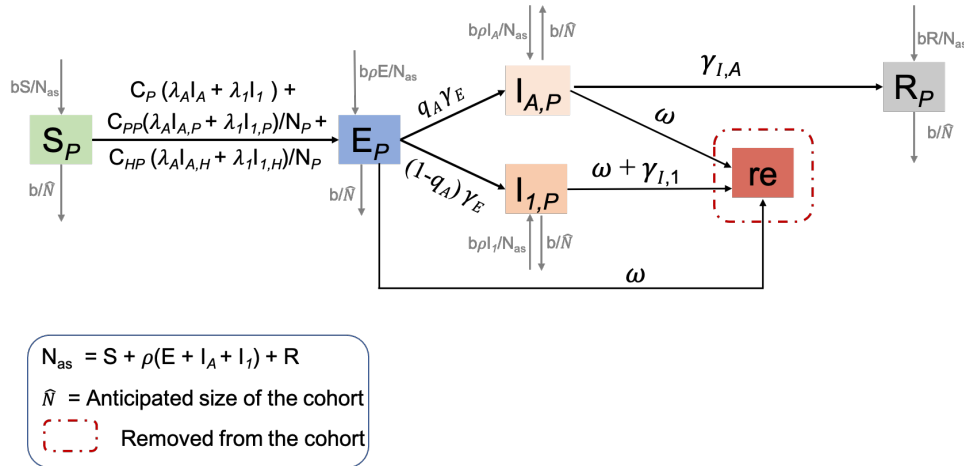

Figure 6: Compartmental model of the dynamics in non-COVID-19 patients

New patients arrive at rate  $b$ . We assume that the arriving patients are chosen randomly from the non-symptomatic population. The probability that a non-symptomatic,

but infected individual enters the population is reduced by a factor  $\rho$ . This means

$$\begin{array}{lll}
 S_P \rightarrow S_P + 1 & N_p \rightarrow N_P + 1 & \text{with rate } \frac{S}{S + \rho(E + I_A + I_1) + R_P} b \\
 E_P \rightarrow E_P + 1 & N_p \rightarrow N_P + 1 & \text{with rate } \frac{E}{S + \rho(E + I_A + I_1) + R_P} \rho b \\
 I_{A,P} \rightarrow I_{A,P} + 1 & N_p \rightarrow N_P + 1 & \text{with rate } \frac{I_A}{S + \rho(E + I_A + I_1) + R_P} \rho b \\
 I_{1,P} \rightarrow I_{1,P} + 1 & N_p \rightarrow N_P + 1 & \text{with rate } \frac{I_1}{S + \rho(E + I_A + I_1) + R_P} \rho b \\
 R_P \rightarrow R_P + 1 & N_p \rightarrow N_P + 1 & \text{with rate } \frac{R_P}{S + \rho(E + I_A + I_1) + R_P} b
 \end{array}$$

We also have departures from the population (deaths or discharge) at combined rate  $b/\hat{N}$  where  $\hat{N}$  is the anticipated size of the cohort. So all of the variables for the patients ( $S_P$ ,  $E_P$ , etc.) all reduce by 1 independently as Poisson processes with rate  $b/\hat{N}$  times their current value (so for example,  $S_P \rightarrow S_P - 1$  and  $N_P \rightarrow N_P - 1$  at rate  $bS_P/\hat{N}$ ).

We assume there are several potential sources of infection for a susceptible patient:

- asymptomatic/presymptomatic infections in the general population, with rate  $C_P(\lambda_A I_A + \lambda_1 I_1)$ .
- Infections from other asymptomatic or presymptomatic patients with rate

$$C_{PP} \frac{\lambda_A I_{A,P} + \lambda_1 I_{1,P}}{N_P}$$

where  $N_P = S_P + E_P + I_{1,P} + I_{A,P} + R_{A,P}$  is the number of patients in the cohort.

- Infections from asymptomatic or presymptomatic HCWs, with rate

$$C_{HP} \frac{\lambda_A I_{A,H} + \lambda_1 I_{1,H}}{N_P}$$

So we find

$$S_P \rightarrow S_P - 1 \quad \text{and} \quad E_P \rightarrow E_P + 1$$

at rate

$$\left( C_P(\lambda_A I_A + \lambda_1 I_1) + \frac{C_{PP}(\lambda_A I_{A,P} + \lambda_1 I_{1,P}) + C_{HP}(\lambda_A I_{A,H} + \lambda_1 I_{1,H})}{N_P} \right) S_P$$

Exposed individuals transition to infectious at rate  $\gamma_E$ , so

$$E_P \rightarrow E_P - 1$$

at rate  $\gamma_E E_P$ . Of those that transition, a fraction  $q_A$  become asymptomatic and  $(1 - q_A)$  become presymptomatic. So when this transition happens, with probability  $q_A$  we have  $I_{A,P} \rightarrow I_{A,P} + 1$  and with probability  $(1 - q_A)$  we have  $I_{1,P} \rightarrow I_{1,P} + 1$ .

Due to testing, infected patients can be removed from the cohort with rate  $\omega$ . This gives:

$$\begin{array}{lll} E_P \rightarrow E_P - 1 & N_P \rightarrow N_P - 1 & \text{with rate } \omega E_P \\ I_{1,P} \rightarrow I_{1,P} - 1 & N_P \rightarrow N_P - 1 & \text{with rate } \omega I_{1,P} \\ I_{A,P} \rightarrow I_{A,P} - 1 & N_P \rightarrow N_P - 1 & \text{with rate } \omega I_{A,P} \end{array}$$

Finally infectious presymptomatic individuals transition to symptomatic and are immediately removed at rate  $\gamma_{I,1}$ , so

$$I_{1,P} \rightarrow I_{1,P} - 1 \quad N_P \rightarrow N_P - 1$$

at rate  $\gamma_{I,1} I_{1,P}$ .

### A.3 Dynamics in HCWs

Note  $N_H = S_H + E_H + I_{1,H} + I_{A,H} + R_H$ , so it does not include quarantined HCWs (Figure 7).

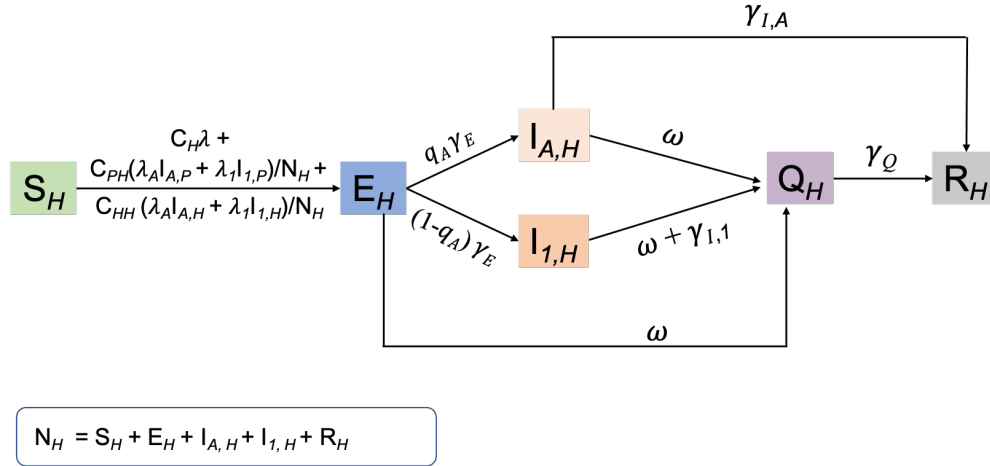

Figure 7: Compartmental model of the dynamics in healthcare workers

We assume that the HCWs in the cohort suffer a force of infection

- from the general public, with rate  $C_H(\lambda_1 I_1 + \lambda_2 I_2 + \lambda_A I_A) = C_H \lambda$  where  $C_H < 1$ .
- a force of infection from their patients.

$$C_{PH} \frac{\lambda_1 I_{1,P} + \lambda_A I_{A,P}}{N_H}$$

where  $N_H$  is the number of active HCWs and  $C_{PH}$  is a factor scaling the patient to HCW transmission rate relative to the patient to patient transmission rate.

- They also experience a force of infection from fellow HCWs

$$C_{HH} \frac{\lambda_1 I_{1,H} + \lambda_A I_{A,H}}{N_H}$$

where  $C_{HH}$  scales the HCW-HCW transmission rate.

So we find

$$S_H \rightarrow S_H - 1 \quad \text{and} \quad E_H \rightarrow E_H + 1$$

with rate

$$\left[ C_H \lambda + \frac{C_{PH} (\lambda_1 I_{1,P} + \lambda_A I_{A,P}) + C_{HH} (\lambda_1 I_{1,H} + \lambda_A I_{A,H})}{N_H} \right] S_H$$

Exposed individuals transition to infectious at rate  $\gamma_E$ . With probability  $q_A$  that transition is to an asymptomatic state, so

$$E_H \rightarrow E_H - 1 \quad \text{and} \quad I_{A,H} \rightarrow I_{A,H} + 1$$

at rate  $q\gamma_E E_H$ . With probability  $1 - q_A$  the transition is to the presymptomatic state, so

$$E_H \rightarrow E_H - 1 \quad \text{and} \quad I_{1,H} \rightarrow I_{1,H} + 1$$

with rate  $(1 - q)\gamma_E E_H$ .

Testing occurs with rate  $\omega$ . Identified individuals are quarantined, temporarily removing them from the active population

$$\begin{array}{llll} E_H \rightarrow E_H - 1 & Q_H \rightarrow Q_H + 1 & N_H \rightarrow N_H - 1 & \text{with rate } \omega E_H \\ I_{1,H} \rightarrow I_{1,H} - 1 & Q_H \rightarrow Q_H + 1 & N_H \rightarrow N_H - 1 & \text{with rate } \omega I_{1,H} \\ I_{A,H} \rightarrow I_{A,H} - 1 & Q_H \rightarrow Q_H + 1 & N_H \rightarrow N_H - 1 & \text{with rate } \omega I_{A,H} \end{array}$$

Infectious presymptomatic HCWs transition to symptomatic  $\gamma_{I,1}$ . These individuals are quarantined and do not interact with others. So this transition reduces  $N_H$  by 1. So

$$I_{1,H} \rightarrow I_{1,H} - 1 \quad Q_H \rightarrow Q_H + 1 \quad \text{and} \quad N_H \rightarrow N_H - 1$$

at rate  $\gamma_{I,1} I_{1,H}$ .

However, they recover and return to the population at rate  $\gamma_Q$ . This transition increases  $N_H$  by 1:

$$Q_H \rightarrow Q_H - 1 \quad R_H \rightarrow R_H + 1 \quad \text{and} \quad N_H \rightarrow N_H + 1$$

The asymptomatic HCWs recover with rate  $\gamma_{I,A}$ , so

$$I_{A,H} \rightarrow I_{A,H} - 1 \quad \text{and} \quad R_H \rightarrow R_H + 1$$

at rate  $\gamma_{I,A} I_{A,H}$



## B Reproduction number within cohort

To calculate the reproduction number within the cohort, we need to calculate the probability that an infected patient or HCW enters each infected state and the expected number of infections within the cohort that result.

We start by looking at a newly infected patient. Note that the probability an infected individual becomes asymptotically infected before being tested or discharged is  $q\gamma_E/(\gamma_E + \omega + b/\hat{N})$  and the probability of becoming presymptomatic is  $(1 - q)\gamma_E/(\gamma_E + \omega + b/\hat{N})$ .

If the patient develops asymptomatic infection, the expected number of new patients infected will be  $C_{PP}\lambda_A/(\gamma_A + \omega)$ . If the patient enters the presymptomatic state, the expected number of new patients infected before being tested or discharged will be  $C_{PP}\lambda_1/(\gamma_1 + \omega + b/\hat{N})$ . The expected number of transmissions to other patients is thus

$$C_{PP}X_P$$

where

$$X_P = \frac{\gamma_E}{\gamma_E + \omega + b/\hat{N}} \left( q \frac{\lambda_A}{\gamma_A + \omega + b/\hat{N}} + (1 - q) \frac{\lambda_1}{\gamma_1 + \omega + b/\hat{N}} \right) \quad (1)$$

The expected number of transmissions to HCWs from an infected patient is  $C_{PH}X$ . Similarly the expected number of transmissions from an infected HCW is  $C_{HP}X_H$  to a patient and  $C_{HH}X_H$  to an HCW where  $X_H$  is the same as  $X_P$ , but with  $b/\hat{N}$  replaced by 0.

So we can capture the number of infections in the “next generation” by the matrix

$$\begin{pmatrix} X_P C_{PP} & X_P C_{PH} \\ X_H C_{HP} & X_H C_{HH} \end{pmatrix}$$

The dominant eigenvalue of this matrix is the reproduction number

$$\mathcal{R}_0 = \left( \frac{X_P C_{PP} + X_H C_{HH}}{2} + \sqrt{\frac{(X_P C_{PP} - X_H C_{HH})^2}{4} + X_P X_H C_{PH} C_{HP}} \right) \quad (2)$$

The expression for  $X_H$  and  $X_P$  suggest increasing the testing rate  $\omega$  would be a particularly important step for reducing  $\mathcal{R}_0$  because it appears in the denominator of the first term and in the denominators of both terms inside the parentheses in (1). Similarly, any interventions that simultaneously impact both infectiousness of infected individuals and susceptibility of susceptible individuals will also have significant impact.

## C Limitations and additional comments

There are some particularly important effects which we have not included in the model:

- We assume that testing continues at a constant rate in the cohort. This neglects an enhanced level of testing that might be expected if an infection is detected.

- We ignore heterogeneity in infectiousness. In the general population, this is not significant. However, as seen in [14, 13], this can have an important impact on the establishment of a disease following introduction. Higher heterogeneity makes diseases less likely to establish, but those that successfully establish have higher average initial growth than predicted from  $\mathcal{R}_0$ .
- We have neglected HCWs transmission from interactions with those involved in the COVID-19 cohort or other non-COVID-19 cohorts.
- We assume that all patients and HCWs are monitored closely enough that individuals are immediately identified once symptomatic.

## Acknowledgment

We thank the National Institutes of Health (NIH) programs Models of Infectious Disease Agent Study (MIDAS) for the support. XQ is supported by the National Institute Of General Medical Sciences of the National Institutes of Health under Award Number U54GM088558. The content is solely the responsibility of the authors and does not necessarily represent the official views of the National Institutes of Health.

Author contributions: JCM conceived of the study, conducted the analysis, wrote and edited the manuscript. XQ conducted the analysis, wrote and edited the manuscript. WPL conceived of the study, wrote and edited the manuscript.

Competing interests: The authors declare no competing interests.

## References

- [1] James R. M. Black, Chris Bailey, and Charles Swanton. COVID-19: the case for health-care worker screening to prevent hospital transmission. *The Lancet*, 2020.
- [2] Sherry L. Burrer, Marie A. de Perio, Michelle M. Hughes, David T. Kuhar, Sara E. Luckhaupt, Clinton J. McDaniel, Rachael M. Porter, Benjamin Silk, Matthew J. Stuckey, and Maroya Walters. Characteristics of Health Care Personnel with COVID-19 — United States, February 12–April 9, 2020. *MMWR. Morbidity and Mortality Weekly Report*, 69(15):477–481, apr 2020.
- [3] Simiao Chen, Zongjiu Zhang, Juntao Yang, Jian Wang, Xiaohui Zhai, Till Bärnighausen, and Chen Wang. Fangcang shelter hospitals: a novel concept for responding to public health emergencies. *The Lancet*, 395(10232):1305–1314, apr 2020.
- [4] Michael Day. Covid-19: identifying and isolating asymptomatic people helped eliminate virus in Italian village.

- [5] Christophe Fraser, Steven Riley, Roy M Anderson, and Neil M Ferguson. Factors that make an infectious disease outbreak controllable. *Proceedings of the National Academy of Sciences*, 101(16):6146–6151, 2004.
- [6] Thomas R. Frieden and Christopher T. Lee. Identifying and Interrupting Superspreading Events—Implications for Control of Severe Acute Respiratory Syndrome Coronavirus 2. *Emerging Infectious Diseases*, 26(6), jun 2020.
- [7] Xi He, Eric H. Y. Lau, Peng Wu, Xilong Deng, Jian Wang, Xinxin Hao, Yiu Chung Lau, Jessica Y. Wong, Yujuan Guan, Xinghua Tan, Xiaoneng Mo, Yanqing Chen, Baolin Liao, Weilie Chen, Fengyu Hu, Qing Zhang, Mingqiu Zhong, Yanrong Wu, Lingzhai Zhao, Fuchun Zhang, Benjamin J. Cowling, Fang Li, and Gabriel M. Leung. Temporal dynamics in viral shedding and transmissibility of COVID-19. *Nature Medicine*, 2020.
- [8] Seung Woo Kim, Jung Wan Park, Hee-Dong Jung, Jeong-Sun Yang, Yong-Shik Park, Changhwan Lee, Kyung Min Kim, Keon-Joo Lee, Donghyok Kwon, Young Joo Hur, Bo Youl Choi, and Moran Ki. Risk factors for transmission of Middle East respiratory syndrome coronavirus infection during the 2015 outbreak in South Korea. *Clinical infectious diseases : an official publication of the Infectious Diseases Society of America*, 64(5):551–557, 2017.
- [9] Anne Kimball, Kelly M. Hatfield, Melissa Arons, Allison James, Joanne Taylor, Kevin Spicer, Ana C. Bardossy, Lisa P. Oakley, Sukarma Tanwar, Zeshan Chisty, Jeneita M. Bell, Mark Methner, Josh Harney, Jessica R. Jacobs, Christina M. Carlson, Heather P. McLaughlin, Nimalie Stone, Shauna Clark, Claire Brostrom-Smith, Libby C. Page, Meagan Kay, James Lewis, Denny Russell, Brian Hiatt, Jessica Gant, Jeffrey S. Duchin, Thomas A. Clark, Margaret A. Honein, Sujana C. Reddy, John A. Jernigan, Atar Baer, Leslie M. Barnard, Eileen Benoliel, Meaghan S. Fagalde, Jessica Ferro, Hal Garcia Smith, Elysia Gonzales, Noel Hatley, Grace Hatt, Michaela Hope, Melinda Huntington-Frazier, Vance Kawakami, Jennifer L. Lenahan, Margaret D. Lukoff, Emily B. Maier, Shelly McKeirnan, Patricia Montgomery, Jennifer L. Morgan, Laura A. Mummert, Sargis Pogojans, Francis X. Riedo, Leilani Schwarcz, Daniel Smith, Steve Stearns, Kaitlyn J. Sykes, Holly Whitney, Hammad Ali, Michelle Banks, Arun Balajee, Eric J. Chow, Barbara Cooper, Dustin W. Currie, Jonathan Dyal, Jessica Healy, Michael Hughes, Temet M. McMichael, Leisha Nolen, Christine Olson, Agam K. Rao, Kristine Schmit, Noah G. Schwartz, Farrell Tobolowsky, Rachael Zacks, and Suzanne Zane. Asymptomatic and Presymptomatic SARS-CoV-2 Infections in Residents of a Long-Term Care Skilled Nursing Facility — King County, Washington, March 2020. *MMWR. Morbidity and Mortality Weekly Report*, 69(13):377–381, apr 2020.
- [10] Qun Li, Xuhua Guan, Peng Wu, Xiaoye Wang, Lei Zhou, Yeqing Tong, Ruiqi Ren, Kathy SM Leung, Eric HY Lau, Jessica Y Wong, et al. Early transmission dynamics in Wuhan, China, of novel coronavirus-infected pneumonia. *New England Journal of Medicine*, 2020.

- [11] Edward Livingston and Karen Bucher. Coronavirus Disease 2019 (COVID-19) in Italy. *JAMA*, 323(14):1335–1335, mar 2020.
- [12] J. O. Lloyd-Smith, S. J. Schreiber, P. E. Kopp, and W. M. Getz. Superspreading and the effect of individual variation on disease emergence. *Nature*, 438(7066):355–359, nov 2005.
- [13] James O Lloyd-Smith, Sebastian J Schreiber, P Ekkehard Kopp, and Wayne M Getz. Superspreading and the effect of individual variation on disease emergence. *Nature*, 438(7066):355–359, 2005.
- [14] Joel C. Miller. A primer on the use of probability generating functions in infectious disease modeling. *Infectious Disease Modelling*, 3:192–248, 2018.
- [15] Kenji Mizumoto, Katsushi Kagaya, Alexander Zarebski, and Gerardo Chowell. Estimating the asymptomatic proportion of coronavirus disease 2019 (COVID-19) cases on board the Diamond Princess cruise ship, Yokohama, Japan, 2020. *Eurosurveillance*, 25(10):2000180, mar 2020.
- [16] Hiroshi Nishiura, Tetsuro Kobayashi, Ayako Suzuki, Sung-Mok Jung, Katsuma Hayashi, Ryo Kinoshita, Yichi Yang, Baoyin Yuan, Andrei R Akhmetzhanov, Natalie M Linton, and Jung S-Mok. Journal Pre-proof Estimation of the asymptomatic ratio of novel coronavirus infections (COVID-19). *International Journal of Infectious Diseases To*, 2020.
- [17] An Pan, Li Liu, Chaolong Wang, Huan Guo, Xingjie Hao, Qi Wang, Jiao Huang, Na He, Hongjie Yu, Xihong Lin, Sheng Wei, and Tangchun Wu. Association of Public Health Interventions With the Epidemiology of the Outbreak in Wuhan, China. *JAMA*, 04 2020.
- [18] Julien Riou and Christian L. Althaus. Pattern of early human-to-human transmission of Wuhan 2019 novel coronavirus (2019-nCoV), December 2019 to January 2020, jan 2020.
- [19] Lisa Rosenbaum. Facing Covid-19 in Italy — Ethics, Logistics, and Therapeutics on the Epidemic’s Front Line. *New England Journal of Medicine*, mar 2020.
- [20] CDC COVID-19 Response Team. Characteristics of health care personnel with covid-19 — united states, february 12–april 9, 2020. *MMWR Morbidity Mortality Weekly Report*, 69:477—481, 2020.
- [21] Christian L. Vestergaard and Mathieu Génois. Temporal Gillespie Algorithm: Fast Simulation of Contagion Processes on Time-Varying Networks. *PLoS Computational Biology*, 11(10):e1004579, 2015.
- [22] Gary Wong, Wenjun Liu, Yingxia Liu, Boping Zhou, Yuhai Bi, and George F. Gao. MERS, SARS, and Ebola: The Role of Super-Spreaders in Infectious Disease, oct 2015.

- [23] Joseph T. Wu, Kathy Leung, and Gabriel M. Leung. Nowcasting and forecasting the potential domestic and international spread of the 2019-nCoV outbreak originating in Wuhan, China: a modelling study. *The Lancet*, 395(10225):689–697, feb 2020.
- [24] Sheng Zhang, Meng Yuan Diao, Wenbo Yu, Lei Pei, Zhaofen Lin, and Dechang Chen. Estimation of the reproductive number of novel coronavirus (COVID-19) and the probable outbreak size on the Diamond Princess cruise ship: A data-driven analysis. *International Journal of Infectious Diseases*, 93:201–204, apr 2020.