

The BathRC model: a method to estimate flow restrictor size for dual ventilation of dissimilar patients

Andrew Plummer¹, Jon du Bois¹, Siu Man Lee², Patrick Magee², Jens Roesner¹, Harinderjit S Gill¹

¹Department of Mechanical Engineering, University of Bath, UK (UoB)

²Royal United Hospital, Bath, UK (RUH)

12th April 2020

Abstract

With large numbers of COVID-19 patients requiring mechanical ventilation and ventilators being in short supply, in extremis two patients are having to share one ventilator. This possibility has been discussed for at least two decades, and careful matching of patient ventilation requirements is advised. However, with a large range of lung compliance and other characteristics, which may also vary with time, good matching is difficult to achieve. Adjusting the impedance of the flow path between ventilator and patient gives the opportunity to control the airway pressure and hence flow and volume individually for each patient. Several groups are now investigating this, in particular the addition of a flow restrictor in the inspiration tube for the patient who is more compliant, or requires a lower tidal volume. In this paper, we show that a simple linear resistance-compliance model, termed the BathRC model, of the ventilator tubing system and lung allows direct calculation of the relationships between pressures, volumes, and required flow restriction. The BathRC model is experimentally validated using a GE Aisys CS2 ventilator connected to two test lungs. The pressure-flow relationships for two restrictors are experimentally determined, and despite the need to approximate them with a linear resistance characteristic, their effect in the breathing circuit is accurately predicted by the simple model. The BathRC model is freely available for download; *we do not condone dual ventilation*, but this tool is provided to demonstrate that flow restriction can be readily estimated. This research is part of a larger test, simulation and design investigation on dual ventilation being undertaken at the UoB and RUH.

Keywords

Dual ventilation, Differential multi-ventilation, Ventilator splitting, Ventilator sharing, Patient matching, COVID-19, Coronavirus, Acute Respiratory Distress Syndrome, ARDS

Acknowledgements

We thank Malcolm Thornton, and Andy Padkin of the RUH for prompting the investigation and enabling testing, and BMI Bath Clinic also for providing test facilities. From the University of Bath, Joe Flynn designed the 3D-printed flow restrictor, and Andrew Avent drew Figure 1. We also wish to acknowledge help and advice from the following University staff: Mauro Carnevale, David Cleaver, Andrew Cookson, Kate Fraser, Pejman Iravani, Evros Loukaides, Alexander Lunt, Anna Young and other members of the Bath Mechanical Ventilation Group.

Models are available here: <https://github.bath.ac.uk/jldb20/twin-ventilator/tree/master/RC>

Contacts

A.R.Plummer@bath.ac.uk

J.L.du.Bois@bath.ac.uk

R.Gill@bath.ac.uk

Prof A R Plummer Director, Centre for Power Transmission & Motion Control

Dr J L du Bois Senior Lecturer in Mechanical Engineering

Prof H S Gill Chair of Healthcare Engineering

NOTE: This preprint reports new research that has not been certified by peer review and should not be used to guide clinical practice.

1. Introduction

Modern ventilators often use a circle anaesthetic breathing system to supply oxygen-enriched air or anaesthetic gases to the patient via an inspiration tube, with expiratory gas returning via a separate expiration tube; exhaled carbon dioxide is either absorbed by an alkali or spilt out of an overflow valve. The splitting of both inspiratory and expiratory tubes, to allow two patients to be ventilated by the same ventilator, has been suggested a number of times, for example in Neyman & Irvin, 2006, and Paladino et al, 2008. However, the potential for cross-flows between patients is a serious concern, and the ability to precisely control pressure and or/flow to each patient is lost. The former problem can be addressed by including additional non-return valves within each of the inspiration and expiration tubes. This has the effect of not only reducing gas contamination between patients, but also of reducing system dead-space for each half of the system, and the potential for CO₂ rebreathing. A method of achieving individual control has not been demonstrated in practice, and COVID-19 patients require ventilation accurately tailored to their needs. In severe Acute Respiratory Distress Syndrome (ARDS), lung compliance can often reduce significantly, although evidence is emerging that COVID-19 is atypical in this regard (Gattinoni, 2020).

Interest in 'Dual Patient Ventilation' (DPV) has been stimulated by the COVID-19 pandemic. In March 2020, this approach was introduced in New York, adopting the 'Columbia Protocol' [1]. This relies on careful matching of patient characteristics, and its effectiveness would be sensitive to changes in in patient compliance. A new experimental study by Tronstad *et al* (2020) in relation to COVID-19 concludes: "*We found large discrepancies in delivered tidal volumes for paired test lungs with compliance differences, little influence from differences in airway resistances, and that higher PEEP settings could strongly influence the tidal volume balance between the test lungs. ... From this study and from a technical point of view, we were not able to identify reliable settings, adjustments or any simple measures to overcome the hazards of the technique.*"

A possible way of allowing DPV for patients with different characteristics – particularly different tidal volume requirements and/or different lung compliance – is to alter the impedance (i.e. resistance or compliance) of the breathing loop to which they are connected, in order to share the delivered tidal volume more appropriately. Increasing the resistance in the inspiration tube for the patient with the higher lung compliance or requiring a lower tidal volume seems plausible. This is the subject of this paper. A team from Hospital Geel, Belgium, have been experimenting with the same technique [2], and a simulation study has been published from a group in (mostly) London, UK, in the last few days (Solís-Lemus *et al*, 2020). This latter paper succinctly reviews previous work on DPV and the challenges involved.

In our research, we have undertaken tests using two GE Aisys CS2 ventilators, taking pressure and flow measurements using Fluke Gas Flow Analysers within single and dual ventilation set ups with test lungs. Some tests were designed to measure individual component characteristics. 180 tests were carried out, acquiring 720 signal time histories. Only a small fraction of this data is used here. Experimental pressure-flow curves for two example restrictors are shown, and the resistance-compliance (RC) network model is validated in a two patient configuration.

Mathematical modelling and simulation of both human respiratory and mechanical ventilation systems is invaluable to help understand novel scenarios such as DPV. Characterising lung mechanical properties using resistance and compliance has become common-place, and estimated values are available from studies such as Arnal *et al* 2018, although other modelling approaches are possible as reviewed in Carvalho and Zin, 2011. Mechanical ventilation and other breathing equipment has been modelled and simulated at the University of Bath since the late 1980's. This has included detailed component modelling and validation (Jones, 2002), and complete system models

reported in Wilson *et al*, 2009. Models were developed using the in-house software tool, *Bathfp*, and used to extensively study low flow breathing systems by Magee, 2014. However, the hypothesis in this paper is that a very simple model is sufficient to predict behaviour adequately, and has the benefit of an analytical solution allowing direct calculation of the flow restrictor resistance required to achieve a specified tidal volume.

2. System architecture and test hardware

In DPV, it is important to prevent cross contamination between patients. The proposed circuit, Figure 1, uses non-return valves in each breathing tube to stop inspiration or expiration back flows. The following hardware was used in the tests described here:

1. Aisys CS2 (Software version 8.0, GE Healthcare, Chicago, USA) anaesthetic ventilator. This is a pneumatic bellows-driven machine. It was operated in Pressure Control Mode (PCV), which is the most appropriate setting for DPV, as the settings for a single patient would not need to change for ventilating two identical patients. In this mode the adjustable settings are:

- PEEP (Positive end-expiratory pressure), the ventilator pressure during expiration.
- P_{insp} (the inspiration pressure in excess of PEEP).
- RR (the respiratory rate, breaths per minute).
- and I:E (inspiration to expiration time ratio).

In PCV, the ventilator effectively controls the driving pressure to transition between PEEP and P_{insp}+PEEP as quickly as possible at the required switching times; any limits or triggers which might alter this profile need to be disabled for dual patient use.

2. Silverknight 22mm breathing tube system (Intersurgical Ltd, Wokingham, UK, Figure 2) and Heat and Moisture Exchange (HME) filters (Clear-Therm 3, Intersurgical, Figure 3).
3. Non-return valves (Ref: 1950000, Intersurgical) – also known as one-way valves or check valves (Figures 2 and 3). As will be seen, these have a significant resistance and so have a notable effect on the ventilation behaviour.
4. Two fixed test lungs (Test Lung 190, Siemens Healthineers, Erlangen, Germany) with different characteristics (Figures 2 and 3).
5. Two Fluke VT Plus HF Gas Flow Analysers (Fluke Biomedical, Everett, Washington, USA, Figure 3)
6. Flow restrictors. Two alternatives are used in the tests included here:
 - a. A fixed restriction provided by an additional Intersurgical non-return valve of the same type as above. This has the benefit of medical approval.
 - b. An adjustable flow restriction device of novel design, 3D-printed at the University of Bath (Figure 4). Only results for the second of 5 discrete positions are shown in this paper.

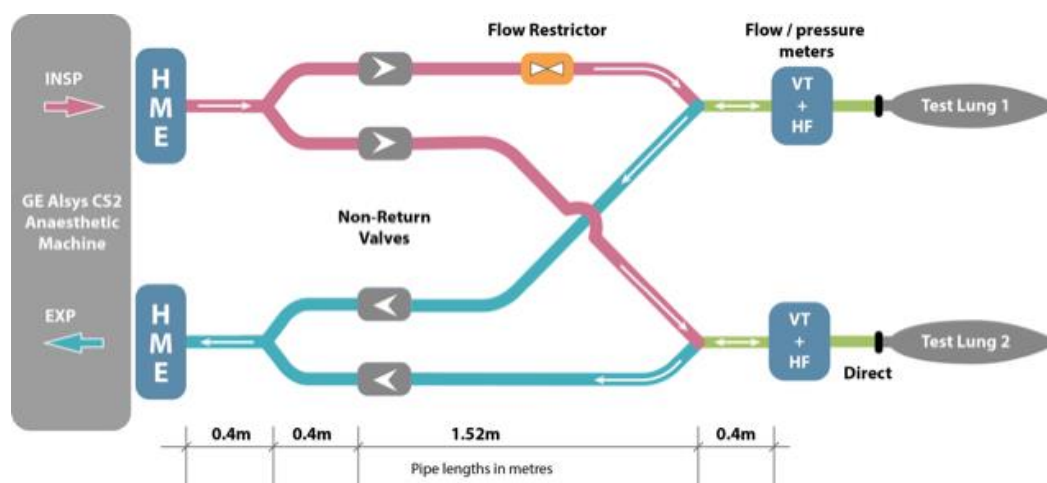

Figure 1. Dual Patient Ventilation test system



Figure 2. Test system components (with acknowledgement to GE Healthcare and Intersurgical)

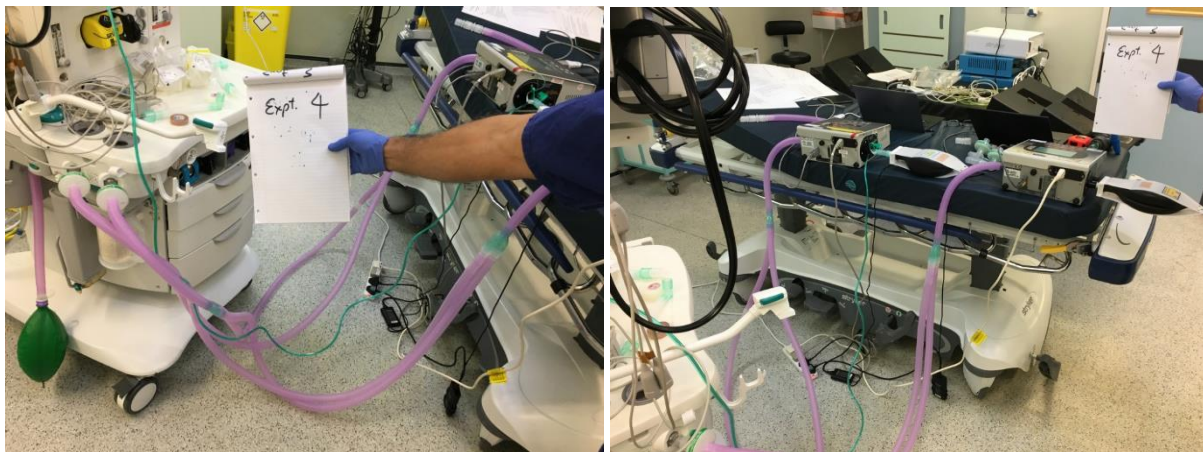

Figure 3. Dual-test lung ventilation system with two Fluke Gas Flow Analysers

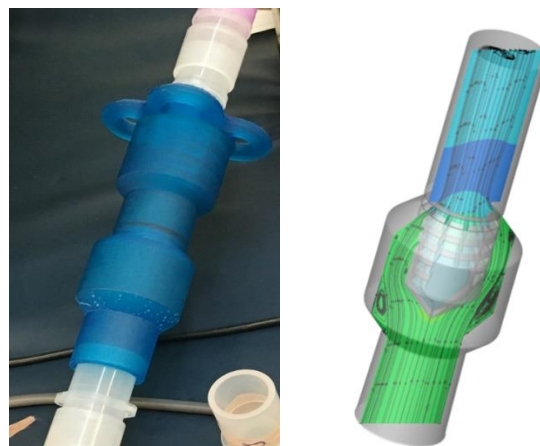

Figure 4. Adjustable flow restrictor, with flow model (right)

The authors are not aware of a suitable variable flow restrictor with medical approval. 3D-printed components, at least using standard resins, are likely to be problematic in terms of sterilisation and life in the warm, moist environment of a breathing system. Typically, components will need be used continuously for about 2 weeks before disposal. A food grade ball valve has also been tested, as well as a constricted 22mm breathing tube, and these test results will appear in a later publication.

Note that, due to increased tube lengths and restrictions due to the non-return valves, the flow characteristics of the patient loops will not be the same as conventional individual ventilation.

3. Mathematical modelling and parameter estimation

3.1 A linear lumped resistance-compliance (RC) network model: the BathRC model

This is a highly simplified model with four terms for single patient ventilation: linear resistance and compliance for ventilator tubing system, and linear resistance and compliance for the patient. Different parameters can be used for inspiration and expiration phases, so there up to eight parameters per patient. The benefit of the RC model is that simple calculations are possible on how patient R and C variation will affect tidal volume, and how this might be corrected by adding a restrictor valve (or possibly other modifications). One scenario could be to calculate what inspiration restriction is required to operate with an increased ventilator pressure (necessitated by ventilator sharing) without increasing the patient's tidal volume undesirably.

As shown in Figure 5, the model consists of the patient lung/airway resistance (R) and compliance (C), and a resistance (R_v) and compliance (C_v) representing the properties of the ventilator tubing system. The airway flow rate, q , is related to the rate of change in airway pressure p_p , according to:

$$R \frac{dq}{dt} + \frac{1}{C} q = \frac{dp_p}{dt} \quad (1)$$

And flow from the ventilator, given by tubing pressure drop divided by resistance, is split between the patient and what is absorbed by tube compliance (including gas compressibility):

$$\frac{p - p_p}{R_v} = q + C_v \frac{dp_p}{dt} \quad (2)$$

Combining equations (1) and (2), the gas volume reaching the patient's lungs, v , can be related to the ventilator pressure, p , by:

$$RCR_v C_v \frac{d^2 v}{dt^2} + (RC + R_v C_v + R_v C) \frac{dv}{dt} + v = C p \quad (3)$$

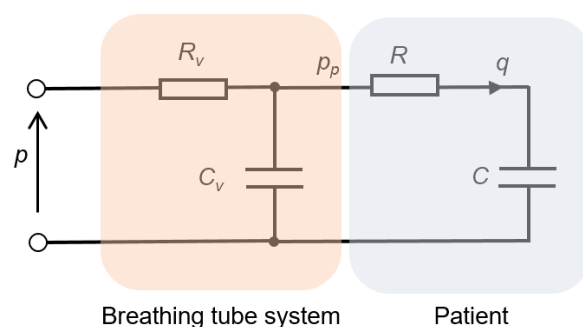

Figure 5. Linear lumped resistance-compliance (RC) network model

Physically realistic parameter values lead to a very small second derivative term, so:

$$(RC + R_v C_v + R_v C) \frac{dv}{dt} + v \approx Cp \quad (4)$$

Due to ventilator or patient properties, the inspiration and expiration parameters may be different. Therefore, the first order response represented by (2) may have different inspiration and expiration time constants, given by:

$$\tau_i = R_i C_i + R_{vi} (C_{vi} + C_i) \quad (5)$$

$$\tau_e = R_e C_e + R_{ve} (C_{ve} + C_e)$$

In pressure control, the ventilator pressure p approximates a series of square pulses. The lung volume during inspiration at time t , in addition to the Functional Residual Capacity (FRC) of the patient's lungs, is given by:

$$v(t) = V_{iss} - (V_{iss} - V_{min})e^{-t/\tau_i} \quad \text{for } 0 \leq t < T_s \quad (6)$$

where V_{iss} is the steady state asymptote of the inspiration phase, V_{min} is the minimum volume, which occurs at the start of inspiration, and T_s is the time at which the ventilator switches from high to low pressure. During expiration the volume is given by:

$$v(t) = V_{ess} + (V_{max} - V_{ess})e^{-(t-T_s)/\tau_e} \quad \text{for } T_s \leq t < T \quad (7)$$

where V_{ess} is the steady state asymptote of the expiration phase, V_{max} is the maximum volume, which occurs at the end of inspiration, and T is the period for the full breathing cycle. These functions are illustrated in Figure 6.

The steady state volumes are given by the product of compliance and pressure:

$$V_{iss} = C_i P_i \quad \text{and} \quad V_{ess} = C_e P_e \quad (8)$$

where P_e is the low pressure setting of the ventilator (PEEP, Positive End-Expiratory Pressure), and P_i is the high pressure used for inspiration.

Maximum volume is reached at the end of inspiration, i.e. at $t = T_s$, and minimum volume is reached at the end of expiration, i.e. at $t = T$, so (6) and (7) can be written at these particular times as:

$$V_{max} = V_{iss} - (V_{iss} - V_{min})e^{-T_s/\tau_i} \quad (9)$$

$$V_{min} = V_{ess} + (V_{max} - V_{ess})e^{-(T-T_s)/\tau_e} \quad (10)$$

Define the following coefficients:

$$a = C_i(1 - b) \quad (11)$$

$$b = e^{-T_s/\tau_i} \quad (12)$$

$$c = C_e(1 - d) \quad (13)$$

$$d = e^{-(T-T_s)/\tau_e} \quad (14)$$

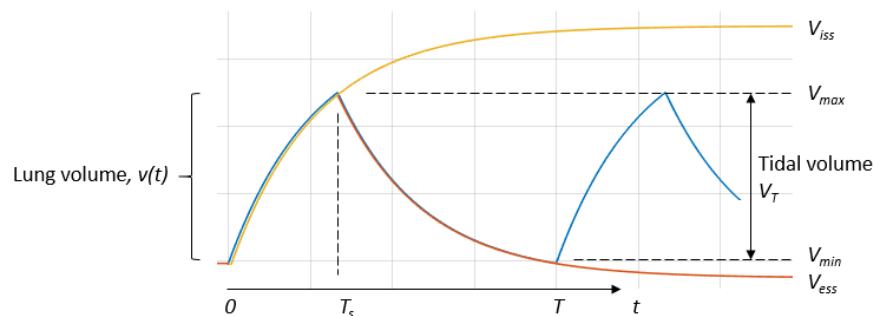

Figure 6. Lung volume waveform

Thus the minimum and maximum volumes are related to the ventilator pressures by:

$$\begin{bmatrix} P_i \\ P_e \end{bmatrix} = \mathbf{K} \begin{bmatrix} V_{max} \\ V_{min} \end{bmatrix} \quad (15)$$

$$\mathbf{K} = \begin{bmatrix} \frac{1}{a} & \frac{-b}{a} \\ -d & 1 \\ \frac{1}{c} & \frac{1}{c} \end{bmatrix} \quad (16)$$

So the maximum and minimum volume and tidal volume (V_T) can be calculated:

$$\begin{bmatrix} V_{max} \\ V_{min} \end{bmatrix} = \mathbf{K}^{-1} \begin{bmatrix} P_i \\ P_e \end{bmatrix} \quad (17)$$

$$V_T = V_{max} - V_{min} \quad (18)$$

Equation (17) is equivalent to:

$$V_{max} = \frac{aP_i + bcP_e}{1 - bd} \quad (19)$$

$$V_{min} = \frac{adP_i + cP_e}{1 - bd}$$

Calculating inspiration restrictor resistance

The resistance required to achieve a specified tidal volume \tilde{V}_T can be found. From (10), (14), and (18):

$$\tilde{V}_{max} = \frac{\tilde{V}_T + (1 - d)V_{ess}}{1 - d} \quad (20)$$

Hence \tilde{V}_{min} can be found from (18), and the new inspiration time constant can be found from (9):

$$\tilde{\tau}_i = -T_s / \ln \left(\frac{V_{iss} - \tilde{V}_{max}}{V_{iss} - \tilde{V}_{min}} \right) \quad (21)$$

From (5), the additional resistance, R_r , in the inspiration line can be found:

$$R_r = \frac{\tilde{\tau}_i - R_i C_i}{C_{vi} + C_i} - R_{vi} \quad (22)$$

Alternatively, if the original tidal volume is required to be maintained but with an increased ventilator pressure P_i , equation (21) can be used with a new value for the end-inspiratory steady state volume V_{iss} given by (8), and (22) can be again used to find the restrictor resistance for the new inspiratory time constant.

As this model does not need a time-marching numerical solution, results can be determined by calculations in, for example, a spreadsheet. A view of such an implementation is given in Appendix 1.

3.2 Parameterisation

Measurements of human airway resistance (R) and lung compliance (C) are available from various studies. Arnal *et al* 2018 found median values for normal lungs of $C = 0.054$ L/(cmH₂O), and slightly different inspiration and expiration resistances, $R_i = 13$ cmH₂O/(L/s) and $R_e = 12$ cmH₂O/(L/s). The median value for ARDS patients was found to be $C = 0.039$ L/(cmH₂O), with little change in resistance, and a lower quartile of $C = 0.032$ L/(cmH₂O).

For the test lungs, parameters were estimated by fitting data from specific tests, giving the values in Table 1. The same values were used for inspiration and expiration. Individual tests have been carried out on lengths of tubing, HME filters and other components. These allowed R_v and C_v to be estimated.

The compliance value was measured as 0.5 mL/(cmH₂O) per metre of tube length, a value consistent with air compressibility combined with deformation of the low-modulus tube wall.

3.3 Flow restrictor characterisation

A series of tests was carried out to determine the pressure-flow characteristics of the flow restrictors. The restrictors were placed in the inspiration line of a test lung loop so they experienced a realistic unidirectional flow regime, and the two gas flow analysers were inserted in the lines either side of the component (Figure 7).

A minimum of 15 cycles of data were collected at 3 different P_{insp} pressures, and with some filtering produced the pressure-flow curves in Figure 8 for the fixed restrictor (non-return valve) and Figure 9 for the adjustable restrictor. The 'mean Q' plotted on the horizontal axis is the average flowrate measured from the two flowmeters. Lines of best fit are shown as well, based on a quadratic function:

$$\Delta p = C_2 Q^2 + C_1 Q + C_0$$

The different best-fit lines are generated by forcing one or more of the coefficients to zero. With $C_2=0$, the function becomes linear. With $C_0=0$ as well, the function becomes proportional, and it is this fit that is used, C_1 being the resistance value. In both cases there are clear errors caused by assuming flow and pressure are proportional. The characteristic for the non-return valve is nearly linear, but there is a cracking pressure of about 1 cmH₂O. The adjustable valve has a pressure drop which is proportional to the square of the flow. The significance of the linear resistance approximation will be can be judged in Section 4.

Table 1. Model parameter values

	Resistance, cmH ₂ O/(L/s)	Compliance, L/(cmH ₂ O),
Test lung 1 (R, C)	12	0.040
Test lung 2(R, C)	12	0.030
Ventilator tubing system (R_v, C_v)	22	0.004
Fixed flow restrictor (R_r)	12	-
Adjustable* flow restrictor (R_r)	33	-

*Note: only used in at one setting in these tests (position 1)



Figure 7. Flow restrictor testing

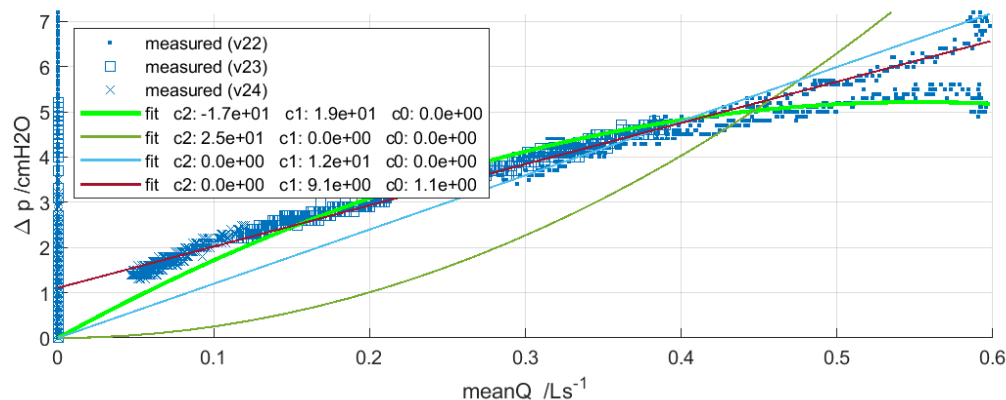

Figure 8. Pressure-flow characteristic for the fixed restrictor (non-return valve)

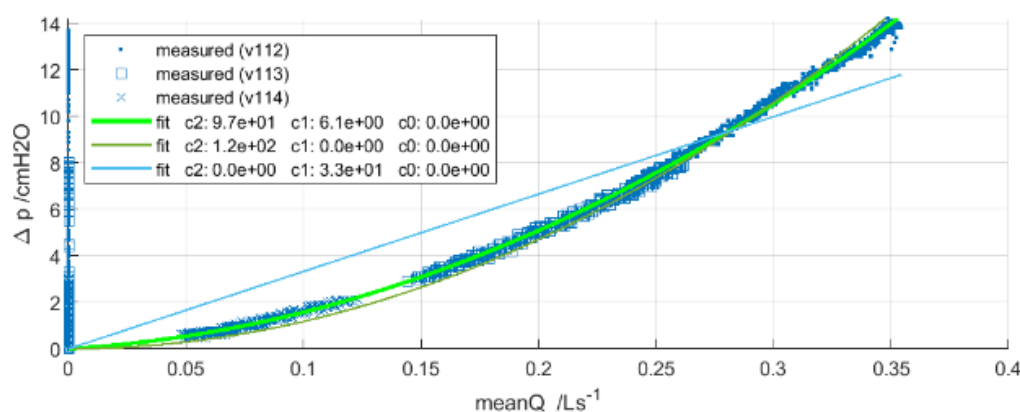

Figure 9. Pressure-flow characteristic for the adjustable restrictor

4. Test results and model validation

Five sets of test results are presented and compared with the model predictions. In all cases the PEEP pressure is 5 cmH₂O, the respiration rate (RR) is 15 breaths per minute, and the I:E ratio is 1:2. As shown in Table 2, two different P_{insp} settings are used, and the inspiration tube for lung 1 either has no restriction, the fixed restrictor, or the adjustable restrictor. The connections to lung 2 remain the same in all tests, with no added restriction.

Table 2. Test conditions, and predicted and measured tidal volumes, V_T . PEEP=5 cmH₂O, RR=15 breaths/min, and I:E ratio is 1:2 for all tests

Test no. & related fig.	Test condition		Tidal volume (L)			
	P _{insp} (cmH ₂ O)	Restrictor (Lung 1)	Lung 1		Lung 2	
			Predicted	Measured	Predicted	Measured
1) Fig.10	25	None	0.541	0.554	0.491	0.498
2) Fig.11	25	Fixed ¹	0.449	0.433	0.491	0.515
3) Fig.12	25	Adjustable ²	0.345	0.357	0.491	0.522
4) Fig.13	15	None	0.324	0.306	0.295	0.282
5) Fig.14	15	Fixed ¹	0.270	0.245	0.295	0.299

¹ Resistance 12 cmH₂O/(L/s) ² Resistance 33 cmH₂O/(L/s)

In Figure 10a, it can be seen that the measured airway flow to both lungs jumps to a peak close to the start of inspiration, and then declines as the lung expands and its pressure increases. Similarly, peak negative (expiration) flow occurs at the start of the expiration phase. It can be seen that the flows for lung 1 are slightly more than lung 2, resulting in a higher tidal volume as seen in Table 2. The model lung volume variations in Figure 10b for lung 1, and Figure 10c for lung 2, match the measured signals well. Note that the volume measurements are actually the integration of the flows, with small offset corrects to prevent drift.

In Test 2, the fixed restrictor is used for lung 1, and now the flows to and from lung 1 are now smaller than lung 2, as seen in Figure 11a. The tidal volume for lung 1 is now reduced by 22% from its unrestricted state. In Test 3, the adjustable restrictor is used for lung 1 which provide a higher resistance, and the lung 1 flows are reduced further (Figure 12a), giving a tidal volume reduction of 36% from its unrestricted state. For Tests 1 to 3 there is no change in the parameters for lung 2, so the model predicts the same tidal volume in each case. However, the measured results indicate a slight increase in volume, amounting to an increase of nearly 5% from Test 1 to Test 3 (Table 2).

To illustrate the change in behaviour and model fit at a different condition, Tests 4 and 5 use an inspiration pressure rise (P_{insp}) of 15 instead of 25 cmH₂O. Comparing lung 1 flow without and with the fixed restrictor - Test 4 (Figure 13) and Test 5 (Figure 14) – shows the expected reduction in flow and a tidal volume drop of 20%, again associated with a small increase in lung 2 tidal volume (6%). An issue which can be seen in the flow plots in Figures 13a and 14a is the lung 1 flow measurement at around 4 s, where the flow sudden becomes zero. This is a low-flow drop out characteristic of that specific flow meter, but the influence on results is thought to be small.

As seen in Table 2, the RC model predicts the tidal volumes reasonably well for this range of conditions. For lung 1, in the five tests the measured tidal volume deviates from the predicted by 2.4%, -3.6%, 3.5%, -5.6% and -9.3% respectively. For lung 2, the measured tidal volume deviates from the predicted by 1.4%, 4.9%, 6.3%, -4.4% and 1.4% respectively. The largest absolute error is 31 mL. For comparison, in [1] a tidal volume change of up to ± 100 mL total for both patients together after their transfer from single to dual ventilation with nominally the same settings is considered acceptable.

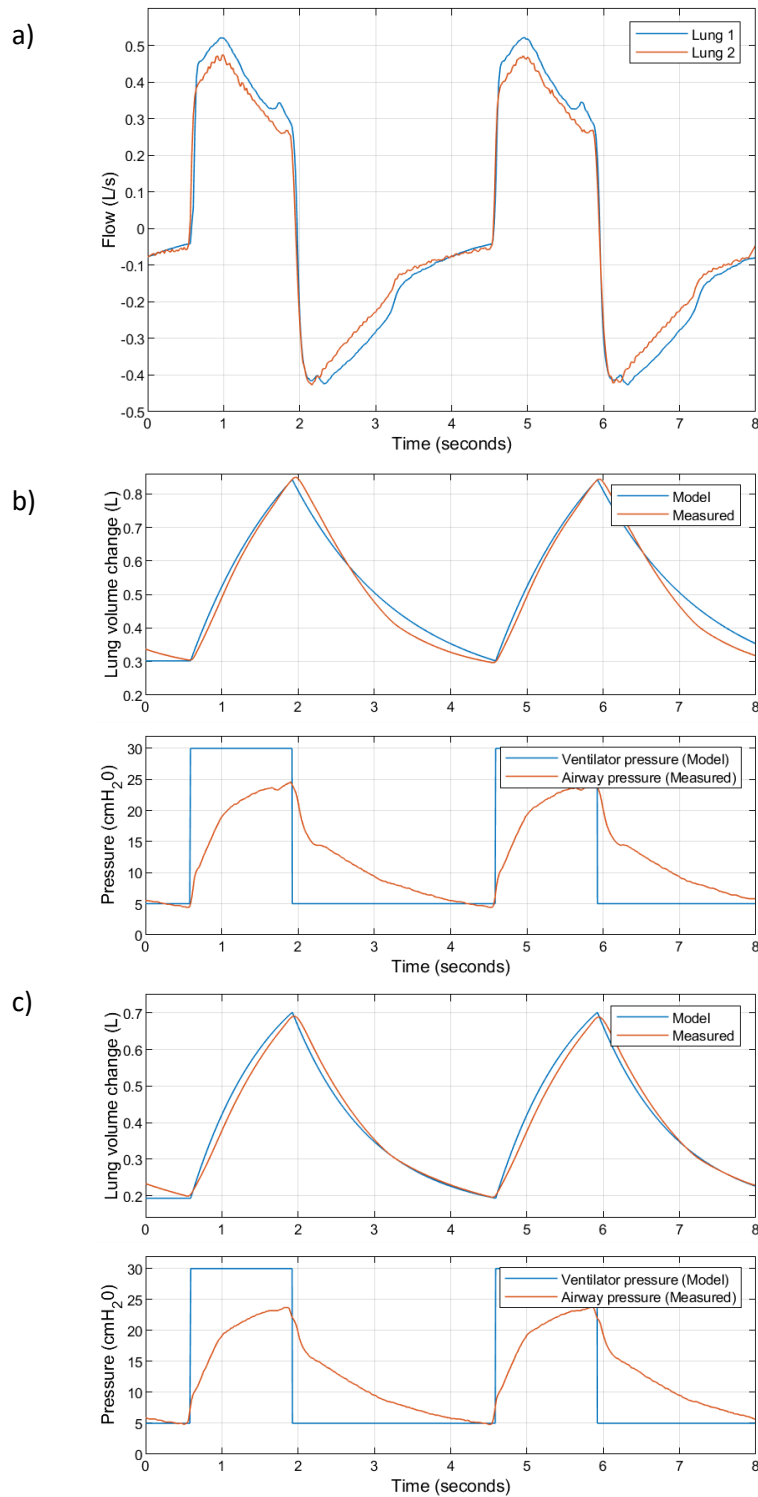

Figure 10. Test 1: P_{insp}=25 cmH₂O, no flow restrictor. a) Measured airway flows b) Lung 1: modelled and measured volumes and pressures c) Lung 2: modelled and measured volumes and pressures

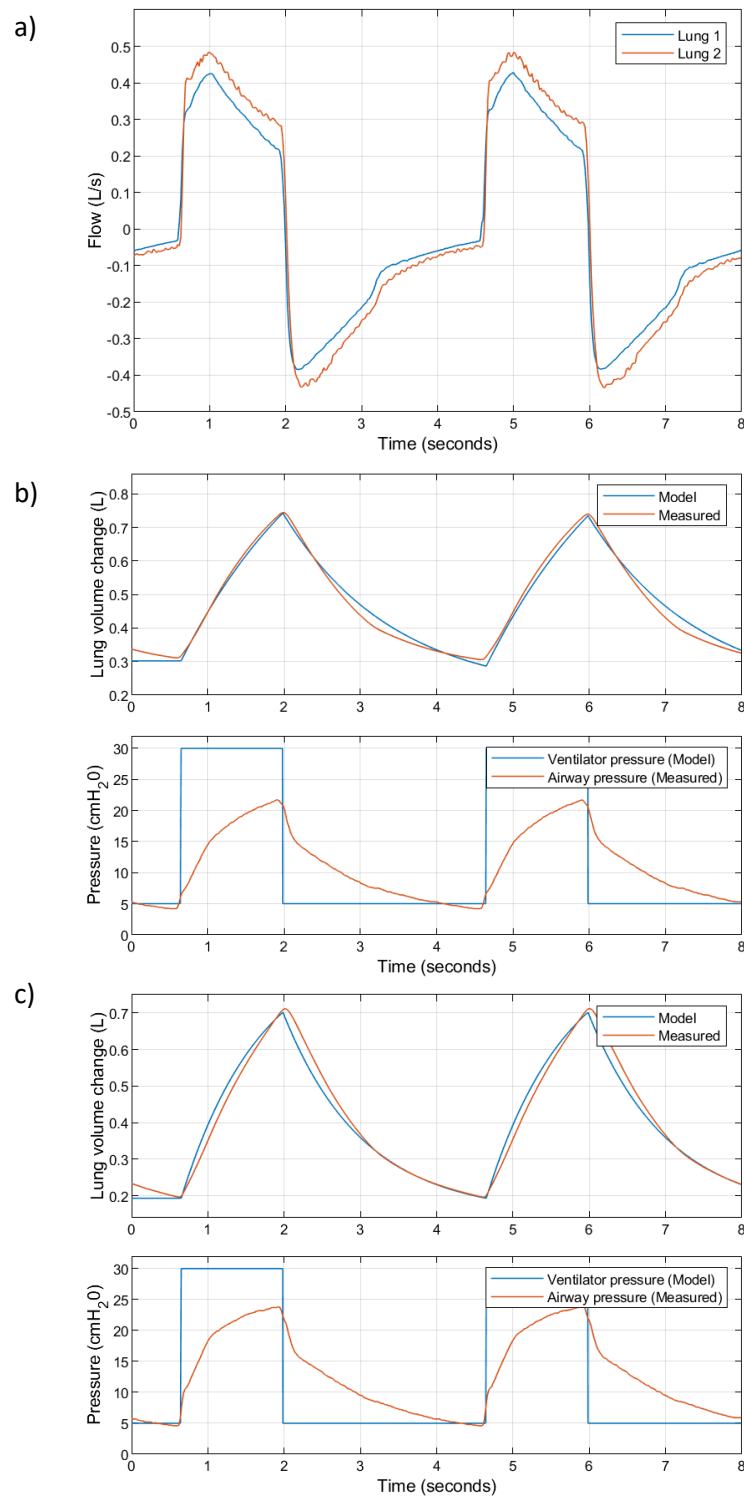

Figure 11. Test 2: P_{insp}=25 cmH₂O, fixed flow restrictor. a) Measured airway flows b) Lung 1: modelled and measured volumes and pressures c) Lung 2: modelled and measured volumes and pressures

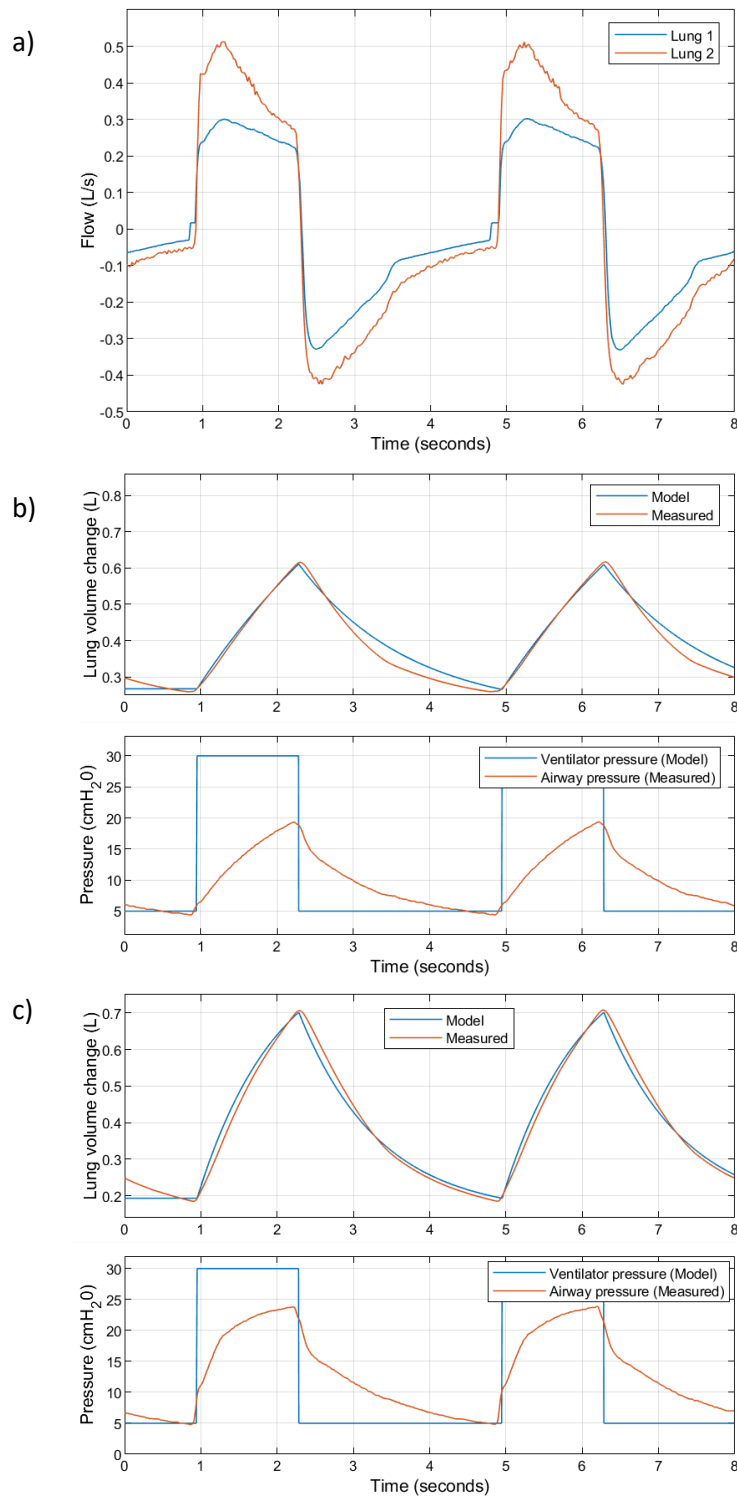

Figure 12. Test 3: $P_{insp}=25$ cmH₂O, adjustable flow restrictor. a) Measured airway flows b) Lung 1: modelled and measured volumes and pressures c) Lung 2: modelled and measured volumes and pressures

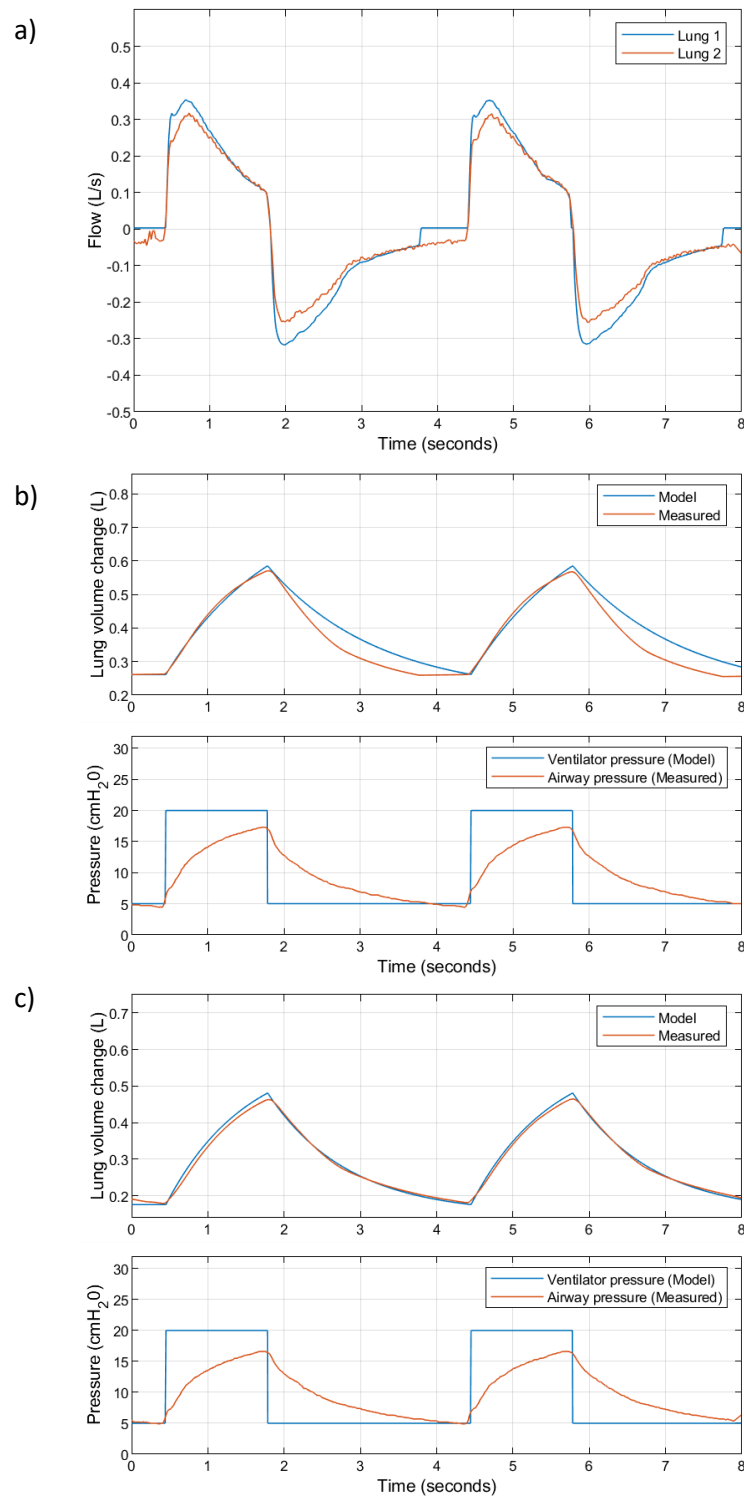

Figure 13. Test 4: P_{insp}=15 cmH₂O, no flow restrictor. a) Measured airway flows b) Lung 1: modelled and measured volumes and pressures c) Lung 2: modelled and measured volumes and pressures

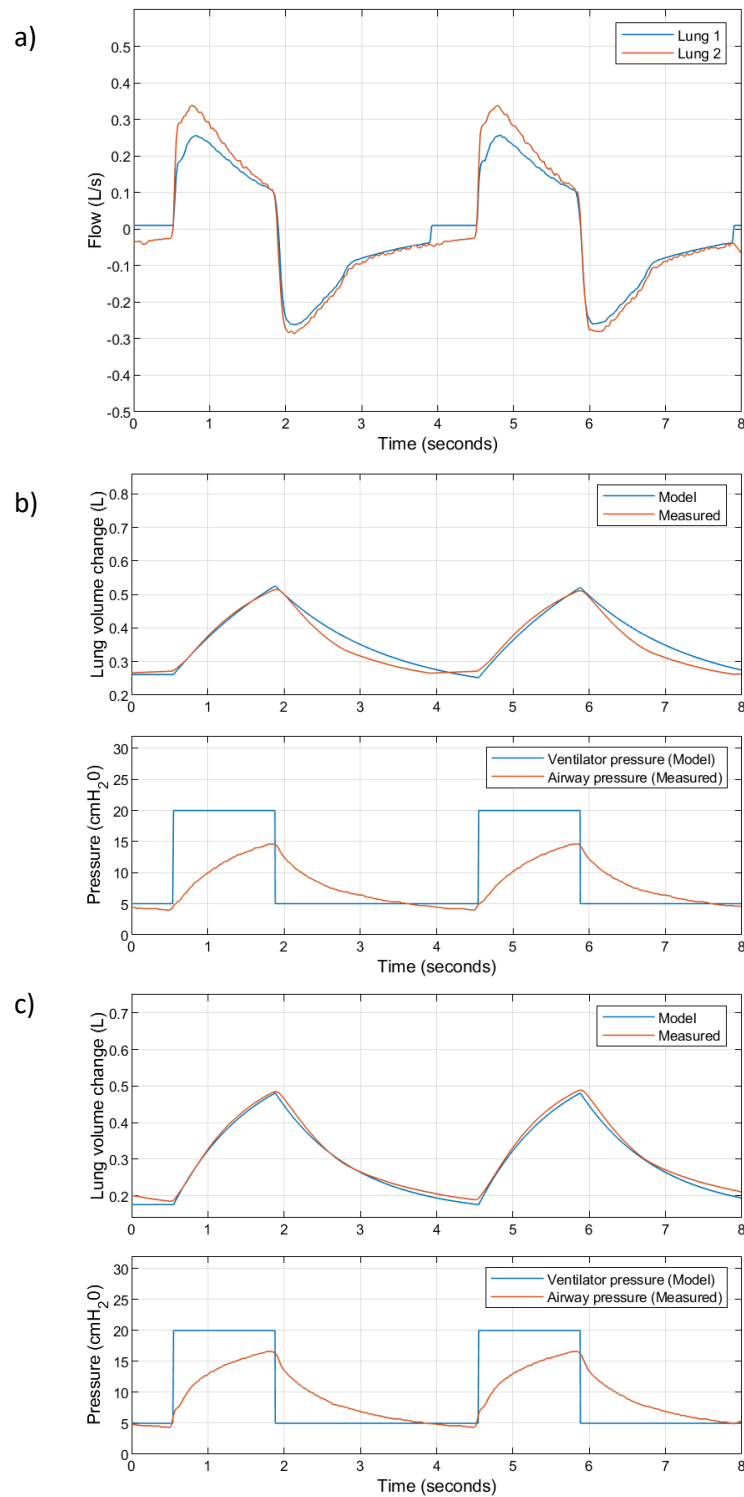

Figure 14. Test 5: P_{insp}=15 cmH₂O, fixed flow restrictor. a) Measured airway flows b) Lung 1: modelled and measured volumes and pressures c) Lung 2: modelled and measured volumes and pressures

5. Conclusions and further work

The University of Bath and the Royal United Hospital in Bath, UK, are investigating dual patient ventilation, where one ventilator is used to ventilate two patients simultaneously. To succeed, we believe it is essential to independently control the gas flow (tidal volume) that each patient receives. A possible solution is to use a flow restrictor in the line of a patient who would otherwise receive too much pressure or flow, resulting in barotrauma or volutrauma. Such a restrictor should ideally be adjustable. We have presented experimental results using a pair of test lungs showing that restricting the flow in one inspiration line does indeed reduce the tidal volume in the corresponding lung. Moreover, using a linear resistance-compliance network model, we have shown that the change of tidal volume can be predicted. In the five tests presented, the largest prediction error was 31 mL of tidal volume. In the form used, the model just needs an airway resistance and lung compliance estimate for each patient, and a resistance and compliance value for the ventilator tubing system. Likewise, an added flow restrictor should be characterised by a linear resistance i.e. a pressure drop proportional to flowrate. The good performance of the model is despite clear linearization errors for the two flow restrictors used in this study. All the parameter values used have been informed by individual component testing.

Some further observations on the results:

- 1) Non-return valves are used in the individual inspiration and expiration tubes, so four in total. The valves we used have a considerable resistance, 12 cmH₂O/(L/s), so contributing over half of the total flow path resistance (either inspiration or expiration) estimated to be 22 cmH₂O/(L/s). While this will mean the characteristics of the dual arrangement are markedly different from conventional single patient ventilation, the increased pressure loss within the flow path means that the airway flow and pressure will be less sensitive to changes in patient characteristics.
- 2) An unexpected result was that as the flow reduced to one test lung by the introduction of a flow restrictor, there was a small increase in flow to the other lung. For example, the most severe flow restrictor reduced tidal volume by 36% in the corresponding lung, but also caused the unaltered loop to provide 5% more volume to the other test lung. This is likely to be caused by the reduced pressure loss in the common part of the circuit at the ventilator, and effects within the ventilator itself.
- 3) Test lung 1 appears to have different time constants for inspiration and expiration, and the modelling approach would allow different inspiration and expiration airway resistances to be used to capture this and improve accuracy. As a general method however, minimising the number of parameters required is beneficial.

A key part of this contribution is that the model is simple to implement, for example as a spreadsheet. An example is provided at the link on the first page. This allows clinicians to estimate the flow restriction needed to match patient requirements. The challenge remains, however, to source a flow restrictor which is medically acceptable, and ideally adjustable. The 3D printed designs that are emerging need to be proven to be inert, sterilisable, and durable in the breathing system environment. The fixed restrictor used in this study – in fact a non-return valve – is medically approved, and provided around 10% differentiation between the two loops. Two or more could be used in series to provide a greater restriction, but an adjustable flow restrictor would be far easier to use.

Some other issues which should be investigated are:

- 1) The effectiveness of the non-return valves in preventing flows (however small) between patients, and whether four, two, or none at all are necessary.

- 2) The addition of sensors to give immediate feedback of the effect of flow restriction. There may be a shortage of ventilators, but providing pressure and flow sensing for both patients ought to be relatively straightforward.
- 3) The ability of a ventilator to maintain the specified pressure when the flow demands have doubled due to dual ventilation needs to be assured, and the effectiveness of the CO₂ scrubbing system.
- 4) A sensitivity analysis of tidal volume and other characteristics to changes in system parameters would be useful. For example, ventilator tubing compliance does not appear to be a significant factor, but this should be confirmed.

A team of academics at UoB, in collaboration with the RUH, are investigating some of these issues. For example, flow restrictor development is underway, and appropriate pressure and flow sensing systems have been prototyped. Ventilation characteristics are being studied with the help of physics-based simulation, using Simscape Gas Flow and Moist Air libraries (MathWorks, Natick, MA, USA), and Simcenter Amesim (Siemens, Plano, TX, USA) which grew out of our own Bathfp simulation tool [5]. This modelling work is supported by the experimental data set recently generated.

It should be noted that the Anesthesia Patient Safety Foundation (APSF) have recently recommended that ventilator sharing should not be undertaken. Some of the objections raised we are addressing in this work [4]. We recognise that no-one would choose to share a ventilator between two patients, but there may be some situations in the near future when there will be no choice. We also recognise the additional challenge this set-up will present to those caring for patients in these circumstances. We believe that manageability and safety mandates limiting the sharing to two patients and not more. Dual patient ventilation is a method of last resort.

References

- Arnal, J-M, Aude Garnero, Mathieu Saoli, and Robert L Chatburn. (2018) Parameters for Simulation of Adult Subjects During Mechanical Ventilation. *Respiratory Care*, Vol 63, No. 2.
- Carvalho, A.R., Zin, W.A. (2011). Respiratory system dynamical mechanical properties: Modelling in time and frequency domain. *Biophys Rev* 3, 71 <https://doi.org/10.1007/s12551-011-0048-5>
- Gattinoni, L., Silvia Coppola , Massimo Cressoni , Mattia Busana , Sandra Rossi , Davide Chiumello. (2020) Covid-19 Does Not Lead to a “Typical” Acute Respiratory Distress Syndrome. *AJRCCM Articles in Press*. Published March 30, 2020 as 10.1164/rccm.202003-0817LE
- Jones, M., (2002) Modelling of Anaesthetic Breathing Systems using Bath fp. PhD Thesis, University of Bath (draft).
- Magee, P. (2014) The mathematical modelling and clinical testing of low flow breathing systems. PhD Thesis, University of Bath
- Neyman, G., & Irvin, C. B. (2006) A single ventilator for multiple simulated patients to meet disaster surge. *Academic Emergency Medicine: Official Journal of the Society for Academic Emergency Medicine*, 13(11), 1246–1249. <https://doi.org/10.1197/j.aem.2006.05.009>

Paladino, L., Silverberg, M., Charchaflied, J. G., Eason, J. K., Wright, B. J., Palamidessi, N., Arquilla, B., Sinert, R., & Manoach, S. (2008) Increasing ventilator surge capacity in disasters: ventilation of four adult-human-sized sheep on a single ventilator with a modified circuit. *Resuscitation*, 77(1), 121–126
<https://doi.org/10.1016/j.resuscitation.2007.10.016>

Solís-Lemus, Jose, Edward Costar, Denis Doorly, Eric C. Kerrigan, Caroline H. Kennedy, Frances Tait, Steven Niederer, Peter E. Vincent and Steven E. Williams (2020) A Simulated Single Ventilator / Dual Patient Ventilation Strategy for Acute Respiratory Distress Syndrome During the COVID-19 Pandemic. medRxiv preprint doi: <https://doi.org/10.1101/2020.04.07.20056309>.

Tronstad, C., T. Martinsen, M. Olsen, L.A. Rosseland, F.J. Pettersen, Ø.G. Martinsen, J.O. Høgetveit, H. Kalvøy (2020) Splitting one ventilator for multiple patients – a technical assessment. Oslo University Hospital / University of Oslo.
https://www.mn.uio.no/fysikk/english/research/projects/bioimpedance/splitting_ventilator.pdf

Wilson AJ, Murphy CM, Brook BS, Breen D, Miles AW, Tilley DG. (2009) A computer model of the artificially ventilated human respiratory system in adult intensive care. *Med Eng Phys*. 2009 Nov;31(9):1118-33. Doi: 10.1016/j.medengphy.2009.07.009.

Websites

1. 'Columbia Protocol' <https://www.gnyha.org/wp-content/uploads/2020/03/Ventilator-Sharing-Protocol-Dual-Patient-Ventilation-with-a-Single-Mechanical-Ventilator-for-Use-during-Critical-Ventilator-Shortages.pdf>
Beitler et al. March 24, 2020 (version 3)
Columbia University College of Physicians & Surgeons / New York-Presbyterian Hospital
Ventilator Sharing Protocol: Dual-Patient Ventilation with a Single Mechanical Ventilator for Use during Critical Ventilator Shortages
2. <https://medium.com/@pinsonhannah/a-better-way-of-connecting-multiple-patients-to-a-single-ventilator-fa9cf42679c6> 'Differential Multiventilation'. Dr. Mergeay, M.D., Dr. Michiel Stiers, M.D., and Dr. Janssen, M.D., hospital Geel, Belgium.
3. https://sofia.medicalistes.fr/spip/IMG/pdf/aisys_cs2_user_s_reference_manual.pdf
GE Aisys CS2 Users' Reference Manual
4. <https://www.apsf.org/news-updates/joint-statement-on-multiple-patient-per-ventilator/>
Anesthesia Patient Safety Foundation's (APSF) recommendations against ventilator sharing
5. https://en.wikipedia.org/wiki/Simcenter_Amesim#cite_note-3

Appendix

A snapshot of a flow restrictor sizing spreadsheet

Calculation of inspiration restrictor resistance to alter patient ventilation characteristics				
Of use for ventilator sharing between patients		White fields are for data entry		
Ventilator settings. Ventilator must in Pressure Control mode				<i>Derived ventilator parameters</i>
Respiration rate (breaths / min)	15.0			Respiration period (s)
Inspiration to expiration time ratio (I/E)	0.5			I to E switching time within period (s)
Pinsp (inspiration pressure above PEEP, cmH2O)	25.0			Max ventilator pressure (cmH2O)
PEEP (cmH2O)	5.0			
Tubing system resistance (cmH2O/(L/s))	20.0			
Tubing system compliance (L/cmH2O)	0.0060			
Patient characteristics				
	A	B	C	D
Inspiration resistance, Ri (cmH2O/(L/s))	13.0	13.0	13.0	13.0
Expiration resistance, Re (cmH2O/(L/s))	13.0	13.0	13.0	13.0
Inspiration Compliance, Ci (L/cmH2O)	0.054	0.044	0.034	0.024
Expiration Compliance, Ce (L/cmH2O)	0.054	0.044	0.034	0.024
<i>Derived patient parameters</i>				
Patient inspiration time constant, RICI (s)	0.70	0.57	0.44	0.31
Patient expiration time constant, ReCe (s)	0.70	0.57	0.44	0.31
<i>Derived system parameters</i>				
Ventilation inspiration time constant (s)	1.90	1.57	1.24	0.91
Ventilation expiration time constant (s)	1.90	1.57	1.24	0.91
Steady end-inspiration lung volume (L)	1.62	1.32	1.02	0.72
Steady end-expiration lung volume (L)	0.27	0.22	0.17	0.12
Max lung volume, in addition to FRC (L)	1.045	0.903	0.753	0.587
Min lung volume, in addition to FRC (L)	0.461	0.345	0.238	0.145
Tidal volume (L)	0.584	0.557	0.515	0.442
Inspiration restriction to achieve a specified tidal volume				
Required tidal volume (L). Must be <= value above	0.442	0.442	0.442	0.442
New max lung volume, in addition to FRC (L)	0.856	0.761	0.670	0.587
New min lung volume, in addition to FRC (L)	0.414	0.319	0.228	0.145
New ventilation inspiration time constant (s)	2.925	2.292	1.634	0.913
Inspiration restrictor needed (cmH2O/(L/s))	17.04	14.39	9.81	0.03
OR inspiration added compliance needed (L/cmH2O)	0.051	0.036	0.020	0.000
Inspiration restriction to achieve the same tidal volume (row 32) with a higher Pinsp pressure				
Higher Pinsp (insp. pressure above PEEP, cmH2O)	30.00	30.00	30.00	30.00
New steady end-inspiration lung volume (L)	1.89	1.54	1.19	0.84
New ventilation inspiration time constant (s)	2.537	2.122	1.714	1.321
Inspiration restrictor needed (cmH2O/(L/s))	10.59	11.00	11.80	13.63

Note: 13 is median for normal lung, Arnal 2018

Note: same as inspiration often used

Note: 0.054 is median for normal lung, Arnal 2018

Note: same as inspiration often used

One breathing cycle, no restrictor

The graph plots Lung volume, above FRC (L) on the y-axis (0 to 1.2) against Time (s) on the x-axis (0 to 5). Four curves represent different patients: A (blue), B (orange), C (light blue), and D (red). All curves start at 0 at time 0 and rise to a peak before decaying towards a steady state. Patient A reaches the highest peak (~1.05 L) and takes the longest time to reach steady state (~4.5 s). Patient D reaches the lowest peak (~0.58 L) and reaches steady state the fastest (~2.5 s).