

1 **The impact of human behavioral adaptation**
2 **stratified by immune status on COVID-19 spread**
3 **with application to South Korea**

4 **Authors:** Sileshi Sintayehu Sharbayta^{1*}, Youngji Jo^{2*}, Jaehun Jung³, Bruno Buonomo⁴

Affiliations:

¹Department of Public Health Sciences, School of Medicine, University of Connecticut Health Center, Connecticut, USA

² Department of Public Health Sciences, School of Medicine, University of Connecticut Health Center, Connecticut, USA

³Department of Preventive Medicine, School of Medicine, Korea University, South Korea

⁴Department of Mathematics and Applications, University of Naples Federico II, via Cintia, I-80126 Naples, Italy

***Corresponding authors**

Youngji Jo: jo@uchc.edu

Sileshi Sintayehu Sharbayta: sharbayta@uchc.edu

Abstract

5 As the COVID-19 pandemic continues with ongoing variant waves and vaccination efforts, population-
6 level immunity and public risk perceptions have shifted. This study presents a behavioral transmission
7 model to assess how virus spread and care-seeking behavior differ based on individuals' immunity sta-
8 tus. We categorized the population into two groups: "partially immune" and "susceptible," which
9 influenced their response to vaccination and testing, as well as their prioritization of information re-
10 lated to disease prevalence and severity. Using COVID-19 data from South Korea (February 1, 2022
11 - May 31, 2022), we calibrated our model to explore these dynamics. Simulation results suggest that
12 increasing reactivity to information among partially immune individuals to the same level as suscep-
13 tible individuals could reduce peak active cases by 16%. Conversely, if partially immune individuals
14 shift their risk perception focus from prevalence (90% prevalence vs. 10% severity) to severity (90%
15 severity vs. 10% prevalence), the peak in active cases could increase by 50%. These findings highlight
16 the need for adaptive vaccination and testing strategies as public risk perceptions evolve due to prior
17 exposures and vaccinations. As new variant waves emerge in the post-pandemic endemic era, our
18 study offers insights into how immunity-based behavioral differences can shape future infection peaks.

19 **Subject class:** 92D30, 92-10, 37N25, 34A34

20 **Keywords:** COVID-19, vaccination, testing, information prioritization, behavioral adaptation, reactivity
21 to information

22 1 Introduction

23 COVID-19 increasingly appears likely to enter long-term circulation and become endemic, necessitating
24 regular vaccinations with updated vaccines, similar to seasonal influenza[1, 2]. Changes in risk percep-
25 tions during the pandemic affect behaviors, including testing and willingness to vaccinate [3]. Patterns of
26 COVID-19 transmission shape the subsequent patterns of behavioral responses to the disease and, in turn,
27 are shaped by such responses. Some models have been developed to help policymakers compare interven-
28 tions such as testing and vaccination [4, 5]. Such models, dependent on various uncertain assumptions,
29 attempt to forecast cases, deaths, and medical supply needs; predict the timing of peaks in cases; and
30 estimate if and when to expect additional waves or surges. Despite the rapid advancements in COVID-19
31 models and forecast tools, very few models [6, 7, 8] directly incorporate adaptive behavioral components
32 to account for changes in risk perceptions, protective behaviors, and compliance with interventions over
33 time, which ultimately influence transmission.

34
35 Compliance with testing and willingness to vaccinate significantly affect disease transmission dynamics
36 and can influence policy recommendations. Hence, modeling how voluntary testing compliance and vac-
37 cination willingness are influenced by individual immune status/history and available public information
38 (e.g., rumors on vaccine efficacy or level of prevalence/severity) is crucial. Coupling transmission models
39 of infectious diseases with models of behavior adaptation has been a growing field of research [9, 10, 11].
40 More specifically, an information index approach was recently employed in epidemic models to account
41 for the social behavior change due to available information related to the disease status in the population
42 [6, 8, 12, 13, 14]. This strategy takes into consideration how the information is distributed; the depen-
43 dence of human behavior not only on the current knowledge but also on the past state of the disease
44 in the population; and how long it takes for the information to reach the general public (information
45 delay). For example, vaccination behavior change due to available information about the prevalence has
46 been considered in a meningitis model[13]. In [14], the authors considered a general SISV (Susceptible-
47 Infectious-Susceptible-Vaccinated) model where transmission (social distancing compliance behavior) and
48 vaccination rate (vaccination decision) depend on prevalence and vaccination roll-out, respectively. Most
49 of these studies, however, often assume a homogeneous population where all individuals react similarly

50 to a single type of information, such as disease prevalence, without considering other critical factors like
51 immune status, severity, mortality rates, or healthcare system strain.

52

53 In this study, we develop a compartmental model to represent the transmission dynamics of COVID-19
54 structured by two different susceptible populations (naive vs. partially immune due to previous infection
55 or vaccination). We then incorporate the information index approach, where the individuals' compliance
56 of vaccination and testing is based on two different kinds of information, namely information about the
57 level of prevalence and severity of the disease. We also take into account the change of risk perception by
58 differing the weighting on information between prevalence and severity among people who are partially
59 immune and not immune (i.e., susceptible) [15, 16, 17].

60

61 The paper is organized as follows: we present the model formulation (Section 2), basic properties of
62 the model (Section 3), and model fitting and parameter estimation (Section 4). We then conduct various
63 numerical simulations (Section 5), which show the role of information-related parameters on the dynamics
64 of the disease. Finally, we discuss the model findings and implications (Section 6).

65 2 Model formulation

66 The entire population (N) is divided into fifteen distinct compartments according to individuals' infection
67 and vaccination status. We divide the transmission dynamics into two categories: primary dynamics,
68 which describes disease transmission for susceptible individuals, and secondary dynamics, which describes
69 transmission among partially immune individuals due to vaccination or previous infection. Each dynamic's
70 transmission is discussed below.

71

72 *(i) Primary and secondary dynamics*

73

74 In primary dynamics there are six compartments: susceptible (*i.e.*, non-immune) individuals (S_1), those
75 who are not yet infected and are susceptible to infection; Vaccinated (V_1), individuals who got vacci-
76 nated with primary series vaccination; Exposed (E_1), individuals who are infected but not yet infectious;
77 Asymptomatic (A_1), people who are infected but do not show symptoms of the disease; Symptomatic
78 people (I_1), those who are infected and show symptoms of the disease; Tested (I_{T1}), individuals who get

79 tested to COVID-19 and their result is positive. Individuals in S_1 class get infected at a rate of λ_1 (the
80 force of infection) and join the exposed class. People in the E_1 class either join the A_1 class at the rate of
81 $(1 - \tau)\epsilon$ or I_1 class at the rate of $\tau\epsilon$, where τ represents the proportion of exposed individuals who become
82 symptomatic and ϵ^{-1} is the latency period. Individuals in the A_1 and I_1 classes get tested for COVID-19
83 at the rate of ξT_1 and T_1 respectively and join the I_{T_1} class, where T_1 is the testing rate. Due to the illness
84 differences among individuals in A_1 and I_1 classes, we assumed their test seeking rates will be different.
85 Therefore, ξ measures the propensity for testing of individuals in the asymptomatic class relative to the
86 symptomatic class. In secondary dynamics, there are seven compartments. These are: susceptible (par-
87 tially immune) compartments, S_2 and S_3 , that contain people who have vaccination history and who have
88 vaccination or infection history respectively, Booster-vaccinated, (V_2); Exposed (E_2), these are individuals
89 infected but not infectious; Asymptomatic (A_2), individuals who are infectious but have no symptoms;
90 Symptomatic (I_2), infectious with symptoms; Tested (I_{T_2}), who are tested for COVID-19 and their result
91 is positive. It has been demonstrated that the immunity level acquired from prior infection, primary series
92 vaccination, and a combination of both (hybrid immunity) vary in their effectiveness against secondary
93 infection or hospitalization [18, 19]. Our study considers the immunity effectiveness remaining until six
94 months after the infection/vaccination based on the study [18], which we utilize to determine protection
95 levels against infection for immune people. Consequently, individuals in the S_2 , S_3 , and V_2 classes get
96 infected at the reduced rates of $(1 - \eta_2)\lambda_2$, $(1 - \eta_3)\lambda_2$ and $(1 - \eta_4)\lambda_2$, respectively, due to these differing
97 immunity levels. The parameters η_2 and η_3 measure the effectiveness of the immunity gained due to vac-
98 cination and prior infection, respectively, after 6 months, whereas η_4 represents the effectiveness of booster
99 vaccination. However, people who get the primary series vaccination, V_1 , can get infected at the rate of
100 $(1 - \eta_1)\lambda_2$, where η_1 measures the effectiveness of the first series vaccination. The transition from primary
101 dynamics to secondary dynamics is either from V_1 or recovery, R at the rate of ϕ . People in the S_2 and
102 S_3 classes get vaccinated at a rate of F_2 , this represents the booster vaccination. People in the E_2 class
103 either join the A_2 class at the rate of $(1 - \tau)\epsilon$ or the I_2 class at the rate of $\tau\epsilon$, where τ, ϵ are as explained
104 in primary dynamics. Individuals in A_2 and I_2 classes get tested for COVID-19 at the rate of ξT_2 and
105 T_2 , respectively, and join the I_{T_2} class, where T_2 is the testing rate and ξ measures the lower propensity
106 for testing of individuals in the A_2 compared to the I_2 class. People in A_1 , A_2 , I_1 , and I_2 classes recover
107 from the disease at the rate of ρ (assumed to be equal), and people in I_{T_1}, I_{T_2} recover at the rate of ρ_t
108 and join R , class. Individuals in I_{T_1} and I_{T_2} classes may progress and be hospitalized, joining the H
109 compartment at the rate of h_1 and h_2 respectively. Vaccination against COVID-19 helps prevent severe

110 illness, resulting in a lower hospitalization rate among individuals in the secondary dynamics ($h_2 < h_1$).
 111 Hospitalized individuals recover from the disease at the rate of ρ_h . Individuals in I_1, I_2 , and H classes die
 112 due to COVID-19 at rates d_1 and d_2 respectively. People are recruited into the Susceptible, S_1 , class by
 113 birth at a rate of π , and individuals in all compartments die naturally at rate μ . The schematic diagram
 114 of the model is shown in Figure 1. The infection, vaccination and testing rate formulations are explained
 115 in depth in the following sub-sections:

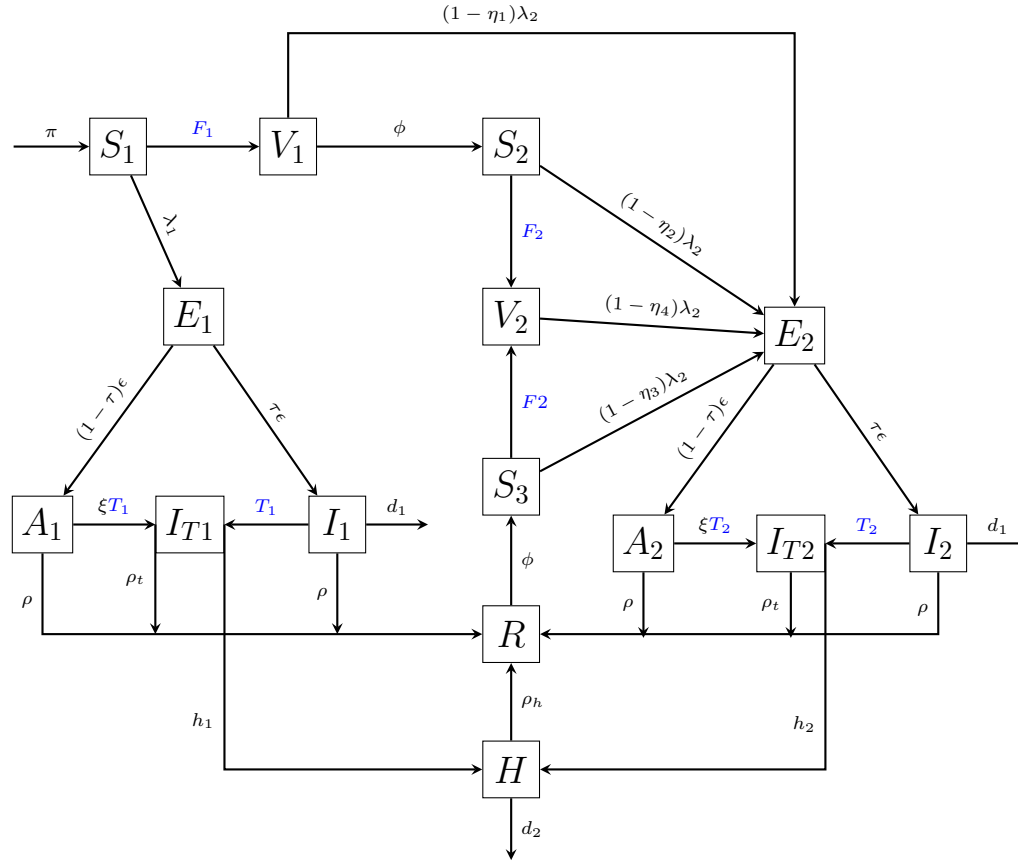

Figure 1: Transmission dynamics of COVID-19. The blue-colored parameters are information dependent parameters. F_1 is a primary series vaccination rate and F_2 is a booster vaccination rate. T_1 and T_2 are testing rates in primary and secondary dynamics respectively.

116 (ii) Force of infection

117

118 Due to immune differences, the transmission rate in primary and secondary dynamics is different [20, 21].
119 Given that mandatory quarantine measures are not commonly enforced nowadays, we assume that a
120 certain proportion of individuals who test positive and all hospital admissions will opt to self-quarantine
121 or isolate themselves, thus they don't contribute to the transmission [22]. With these assumptions, the
122 forces of infection are given by:

$$\lambda_1 = \beta_1 \frac{I_1 + I_2 + \psi(A_1 + A_2) + (1 - \delta)(I_{T1} + I_{T2})}{N - (H + \delta(I_{T1} + I_{T2}))}, \quad \lambda_2 = \beta_2 \frac{I_1 + I_2 + \psi(A_1 + A_2) + (1 - \delta)(I_{T1} + I_{T2})}{N - (H + \delta(I_{T1} + I_{T2}))}, \quad (1)$$

where N is the total population and is given by :

$$N = S_1 + S_2 + S_3 + V_1 + V_2 + E_1 + E_2 + A_1 + A_2 + I_1 + I_2 + H + I_{T1} + I_{T2} + R,$$

123 and β_1 and β_2 are the transmission rates in primary and secondary dynamics respectively, δ is percentage
124 of tested individuals who quarantine and ψ represents infectiousness modification of asymptomatic indi-
125 viduals.

126

127 *(iii) Vaccination and testing rates*

128

129 The vaccination and testing rates are both described by the sum of two rates: mandatory and voluntary
130 rates. First, the mandatory vaccination and testing rates represent the rates for the portion of the
131 population that will be vaccinated or tested regardless of the information. This term summarizes some
132 aspects of vaccine acceptance or test seeking of individuals that are strongly in favor of vaccines or advised
133 to get tested, or specific population groups (e.g., older age groups, teachers or health workers) for which
134 the vaccination or testing is mandatory or strongly recommended by the authorities. These rates are
135 represented by a constant rate. These constant rates are represented by F_{10} (mandatory primary series
136 vaccination rate), F_{20} (mandatory booster vaccination rate) and T_{10} (mandatory testing rate in primary
137 dynamics), T_{20} (mandatory testing rate in secondary dynamics), respectively. Second, the voluntary rate
138 is a rate for a portion of the population voluntarily choosing to be vaccinated or tested depending on
139 the level of disease prevalence and severity in the society. We use the information index to represent
140 the publicly available information or rumors about the prevalence and severity of the disease. We use
141 the reported number of people dead and hospitalized to represent the level of severity of the disease. In

142 these formulations, we made two assumptions: first, partially immune people have a lower perception
 143 of the risk of infection, and second, partially immune and susceptible people prioritize prevalence and
 144 severity information differently. The Holling type *II* function, (characterized by saturating, continuous,
 145 differentiable, and increasing function), is commonly used to represent the voluntary rate [8, 13]. Based
 146 on the above discussion, the vaccination and testing rates are given by:

$$F_1(\mathcal{V}, \mathcal{N}) = F_{10} + (F_{\max} - F_{10}) \left(\alpha_1 \frac{\tilde{D}\mathcal{V}}{1 + \tilde{D}\mathcal{V}} + (1 - \alpha_1) \frac{\tilde{B}\mathcal{N}}{1 + \tilde{B}\mathcal{N}} \right), \quad (2)$$

$$T_1(\mathcal{V}, \mathcal{N}) = T_{10} + (T_{\max} - T_{10}) \left(\alpha_1 \frac{D\mathcal{V}}{1 + D\mathcal{V}} + (1 - \alpha_1) \frac{B\mathcal{N}}{1 + B\mathcal{N}} \right), \quad (3)$$

148 and

$$F_2(\mathcal{V}, \mathcal{N}) = F_{20} + (F_{\max} - F_{20}) \left(\alpha_2 \frac{\theta\tilde{D}\mathcal{V}}{1 + \theta\tilde{D}\mathcal{V}} + (1 - \alpha_2) \frac{\theta\tilde{B}\mathcal{N}}{1 + \theta\tilde{B}\mathcal{N}} \right), \quad (4)$$

$$T_2(\mathcal{V}, \mathcal{N}) = T_{20} + (T_{\max} - T_{20}) \left(\alpha_2 \frac{\theta D\mathcal{V}}{1 + \theta D\mathcal{V}} + (1 - \alpha_2) \frac{\theta B\mathcal{N}}{1 + \theta B\mathcal{N}} \right), \quad (5)$$

150 where \tilde{D} , \tilde{B} , D , and B are positive factors that adjust the reactivity of individuals to the information in
 151 vaccination (\tilde{D} , and \tilde{B}) and testing (D and B) rates, F_{\max} and T_{\max} represent the maximum vaccination
 152 and testing rates, respectively, that can be achieved in the case of a high level of information coverage
 153 about the disease status (or high level of risk perception), θ represents the reduced reactivity to risk
 154 perception by individuals in the second dynamics relative to individuals in primary dynamics. The weight
 155 given by individuals to the prevalence information in primary and secondary dynamics is measured by α_1
 156 and α_2 , respectively. The corresponding complementary weights, $1 - \alpha_1$ and $1 - \alpha_2$, are assigned to the
 157 severity information. The variables \mathcal{V} and \mathcal{N} are the information indices that represents the information
 158 available to the public or rumors about the level of prevalence and severity, respectively and are given by
 159 the following delayed distributions:

$$\mathcal{V}(t) = \int_0^\infty g_1(t-x) a e^{-ax} dx, \quad (6)$$

160 and

$$\mathcal{N}(t) = \int_0^\infty g_2(t-x) a e^{-ax} dx, \quad (7)$$

161 where a represents the inverse of the average time delay for the information to reach the general public, and
162 the functions $g_1(t)$ and $g_2(t)$ represent people's perception of the risk of infection and the level of severity
163 of the disease, respectively (often called message functions). Perceived risk of infection and severity are
164 assumed to depend on the number of symptomatic individuals ($I_1 + I_2 + I_{T1} + I_{T2} + H$) and number of
165 hospitalized and dead people ($H + d_1(I_1 + I_2) + d_2H$) respectively. Thus, the message functions are given
166 by

$$\begin{aligned} g_1(t) &= \frac{k(I_1(t) + I_2(t) + I_{T1}(t) + I_{T2}(t) + H(t))}{N_0}, \\ g_2(t) &= \frac{k(H(t) + d_1(I_1(t) + I_2(t)) + d_2H(t))}{N_0}, \end{aligned} \quad (8)$$

167 where the quantity k represents information coverage. We define information coverage as the publicly
168 available information or rumors about the disease status [13, 14] and N_0 is the steady state population
169 when there is no disease and no disease-induced death (i.e., $N_0 = \frac{\pi}{\mu}$). Asymptomatic people are often
170 unreported and hidden from the public, therefore they are not included in information indices. The
171 formulation in equations (6) and (7) represents that the population's memory about the perceived risk is
172 fading exponentially. The term ae^{-at} is often known as the *exponential fading kernel* [23]. It represents
173 the weight given to the current and past values of the disease. Utilizing the *linear chain trick* method
174 [24], the integral equations (6) and (7) can be reduced into ordinary differential equations (ODEs), given
175 by

$$\begin{aligned} \dot{\mathcal{V}} &= a \left(k \frac{(I_1 + I_2 + I_{T1} + I_{T2} + H)}{N_0} - \mathcal{V} \right), \\ \dot{\mathcal{N}} &= a \left(k \frac{(H + d_1(I_1 + I_2) + d_2H)}{N_0} - \mathcal{N} \right), \end{aligned} \quad (9)$$

176 where the upper dot denotes the time derivative.

177 Based on the above discussions, the system under study is governed by the following non-linear ODEs.

$$\begin{aligned}
 \dot{S}_1 &= \pi - (\lambda_1 + F_1 + \mu)S_1, \\
 \dot{S}_2 &= \phi V_1 - ((1 - \eta_2)\lambda_2 + F_2 + \mu)S_2, \\
 \dot{S}_3 &= \phi R - ((1 - \eta_3)\lambda_2 + F_2 + \mu)S_3, \\
 \dot{V}_1 &= F_1 S_1 - \phi V_1 - (1 - \eta_1)\lambda_2 V_1 - \mu V_1, \\
 \dot{V}_2 &= F_2 S_2 + F_2 S_3 - (1 - \eta_4)\lambda_2 V_2 - \mu V_2, \\
 \dot{E}_1 &= \lambda_1 S_1 - (\epsilon + \mu)E_1, \\
 \dot{E}_2 &= \lambda_2((1 - \eta_1)V_1 + (1 - \eta_4)V_2 + (1 - \eta_2)S_2 + (1 - \eta_3)S_3) - (\epsilon + \mu)E_2, \\
 \dot{A}_j &= (1 - \tau)\epsilon E_j - \xi T_j A_j - (\rho + \mu)A_j, \\
 \dot{I}_j &= \tau \epsilon E_j - T_j I_j - (\rho + \mu + d_1)I_j, \\
 \dot{I}_{Tj} &= T_j(I_j + \xi A_j) - (\rho_t + \mu + h_1)I_{Tj}, \\
 \dot{H} &= h_1 I_{T1} + h_2 I_{T2} - \rho_h H - (d_2 + \mu)H \\
 \dot{R} &= \rho(A_1 + A_2 + I_1 + I_2) + \rho_t(I_{T1} + I_{T2}) + \rho_h H - (\phi + \mu)R, \\
 \dot{\mathcal{V}} &= a \left(\frac{k(I_1 + I_2 + I_{T1} + I_{T2} + H)}{N_0} - \mathcal{V} \right) \\
 \dot{\mathcal{N}} &= a \left(\frac{k(H + d_1(I_1 + I_2) + d_2 H)}{N_0} - \mathcal{N} \right),
 \end{aligned} \tag{10}$$

178 with initial conditions:

$$\begin{aligned}
 S_1(0) &> 0, S_2(0) \geq 0, S_3(0) \geq 0, V_j(0) \geq 0, E_j(0) \geq 0, A_j(0) \geq 0, I_j(0) \geq 0, I_{Tj} \geq 0, \\
 H(0) &\geq 0, R(0) \geq 0, \mathcal{V}(0) \geq 0, \mathcal{N}(0) \geq 0,
 \end{aligned} \tag{11}$$

179 where $j \in \{1, 2\}$.

180 3 Basic properties

181 In this section, we investigate the basic characteristics of the model (10), which include ensuring the
 182 positivity and boundedness of solutions, computing the disease-free equilibrium, and determining the re-
 183 production number.

184

185 (i) Positivity and boundedness of solutions

186

187 Positivity and boundedness of the solutions can be established in standard ways (see e.g., [25, 26]).

188

189 (ii) Disease-free equilibrium and the reproduction number

190

191 A disease-free equilibrium point is an equilibrium point at which there are no infected individuals in
192 the population (no disease). Setting all infected compartments of the system (10) to zero and solving the
193 reduced system of equations by equating to zero, we get the disease-free equilibrium point, denoted by
194 E^0 , and given by

$$E^0 = (S_1^0, S_2^0, S_3^0, V_1^0, V_2^0, I^0), \quad (12)$$

195 where

$$\begin{aligned} S_1^0 &= \frac{\pi}{F_{10} + \mu}, \\ S_2^0 &= \frac{\pi \phi F_{10}}{(F_{10} + \mu)(F_{20} + \mu)(\phi + \mu)}, \\ S_3^0 &= 0, \\ V_1^0 &= \frac{\pi F_{10}}{(F_{10} + \mu)(\phi + \mu)}, \\ V_2^0 &= \frac{\pi \phi F_{10} F_{20}}{\mu(F_{10} + \mu)(F_{20} + \mu)(\phi + \mu)}, \\ I^0 &= (E_1^0, E_2^0, A_1^0, A_2^0, I_1^0, I_2^0, I_{T1}^0, I_{T2}^0, H^0, R^0, D^0, \mathcal{V}^0, \mathcal{N}^0) = \mathbf{0}, \end{aligned}$$

196 where $\mathbf{0}$ represents a zero vector of dimension 1×13 .

197

198 The effective reproduction number is the expected number of new infections caused by an infectious
199 individual in a population where some individuals may no longer be susceptible (due to obtained immu-
200 nity from prior infection or vaccination) [27].

201 We used the next-generation matrix method to calculate the effective reproduction number for the model
202 (10). This method follows the following three steps (for detailed explanations, one can refer to [28, 29]):

203

Step I: We sort out the equations for infected compartments $(E_1, E_2, A_1, A_2, I_1, I_2, I_{T1}, I_{T2}, H)$ and split

the right-hand side of the equations as

$$\mathcal{F}_i - \mathcal{G}_i,$$

204 where \mathcal{F}_i represents the rate of appearance of new infections in compartment i and \mathcal{G}_i incorporates the
205 remaining terms representing the transition of people into and out of the compartments.

206

207 *Step II:* Determine the following matrices that are obtained by linearizing the equations in Step I and
208 evaluating at the disease-free equilibrium.

$$F = \left[\frac{\partial \mathcal{F}_i(E^0)}{\partial x_j} \right] \quad \text{and} \quad G = \left[\frac{\partial \mathcal{G}_i(E^0)}{\partial x_j} \right],$$

where x represents the infected compartments.

The next-generation matrix is defined as

$$FG^{-1}.$$

Step III: Find the reproduction number using

$$R_e = \rho(FG^{-1}),$$

209 where ρ is the spectral radius of the matrix and is defined as the maximum of the absolute values of the
210 eigenvalues of the matrix FG^{-1} .

211 Following the above steps, the effective reproduction number, R_e , is given by

$$R_e = [FI_p + FI_s], \tag{13}$$

212 where

213 FI_p and FI_s represents the effective reproduction number for primary dynamics and secondary dynamics,

214 respectively, and are given by

$$\begin{aligned}
 FI_p &= \frac{C_1 \epsilon}{\epsilon + \mu} \left[\underbrace{\frac{M_1(1-\delta)\tau T_{10} + M_2(1-\delta)(1-\tau)\xi T_{10}}{M_1 M_2 M_3}}_{\text{infection from tested but non-isolated}(I_{T1})} + \underbrace{\frac{\tau}{M_2}}_{\text{infection from symptomatic}(I_1)} + \underbrace{\frac{(1-\tau)\psi}{M_1}}_{\text{infection from asymptomatic}(A_1)} \right], \\
 FI_s &= \frac{C_2 \epsilon}{\epsilon + \mu} \left[\underbrace{\frac{M_5(1-\delta)\tau T_{20} + M_4(1-\delta)(1-\tau)\xi T_{20}}{M_4 M_5 M_6}}_{\text{infection from tested but non-isolated}(I_{T2})} + \underbrace{\frac{\tau}{M_4}}_{\text{infection from symptomatic}(I_2)} + \underbrace{\frac{(1-\tau)\psi}{M_5}}_{\text{infection from asymptomatic}(A_2)} \right],
 \end{aligned}$$

215 and,

$$\begin{aligned}
 C_1 &= \frac{\beta_1 S_1^0}{S_1^0 + S_2^0 + V_1^0 + V_2^0}, \\
 C_2 &= \frac{\beta_2}{S_1^0 + S_2^0 + V_1^0 + V_2^0} \left((1-\eta_2)S_2^0 + (1-\eta_1)V_1^0 + (1-\eta_4)V_2^0 \right), \\
 M_1 &= \rho + \mu + \xi T_{10}, \\
 M_2 &= \rho + d_1 + \mu + T_{10}, \\
 M_3 &= \rho_t + h_1 + \mu, \\
 M_4 &= \rho + d_1 + \mu + T_{20}, \\
 M_5 &= \rho + \mu + \xi T_{20}, \\
 M_6 &= \rho_t + h_2 + \mu.
 \end{aligned}$$

216 **Remark 1.** Note that:

- 217 • The basic reproduction number, i.e., the mean number of secondary cases a typical single infected
- 218 case will cause in a fully susceptible population in the absence of interventions, for the model (10)
- 219 can be found by setting the mandatory vaccination rates (F_{10} and F_{20}) and mandatory testing rates
- 220 (T_{10} and T_{10}) to zero.
- 221 • The parameters related to voluntary vaccination and testing (like, information coverage, information
- 222 delay time, reactivity to information, information prioritization and reduced level of reactivity by
- 223 immune individuals) don't appear in the effective reproduction formula. Hence, they will not affect
- 224 the threshold value ($R_e = 1$) in Theorem 1.

225 **Theorem 1.** The disease-free equilibrium, E^0 , of the model (10) is locally asymptotically stable if $R_e < 1$

226 *and unstable if $R_e > 1$.*

227 *Proof.* The proof follows from Theorem 2 in [29]. □

228 4 Model fitting and parameter estimation

229 In this section, we will discuss how we set the model's baseline parameter values. The parameter values in
230 the model are determined in two ways: first, using demographic and epidemiological data obtained from
231 Our World in Data [30] and previous research, which is mentioned as a reference in Table 1, and second,
232 by fitting the model to the Korean COVID-19 vaccination, incidence and mortality data collected during
233 the omicron variant wave with time period from February 01, 2022, to May 31, 2022. We will discuss the
234 details of each method in the following sections.

235

236 *(i) Values of known parameters and initial conditions for the model*

237

238 According to the data from Our World in Data, the estimated population of South Korea in 2022 is
239 $N(0) = 51815808$ (the initial population used in the simulation) and the life expectancy is 83 years [30].
240 Therefore, the daily natural death rate can be calculated as $\mu = \frac{1}{83 \times 365}$ and the daily birth rate is obtained
241 by $\pi = \mu \times N(0) = 1710$ [31]. The mandatory primary series vaccination rates and the maximum vacci-
242 nation rate are estimated from the data [30]. We estimated the maximum vaccination rate, F_{\max} , to be
243 the maximum proportion of daily vaccinated people given by: $F_{\max} = \frac{1382042}{51815808} = 0.027$. The mandatory
244 vaccination rate, F_{10} , is obtained by calculating the average of the daily proportion of vaccinated people
245 prior to the initial time for our simulation (February 01, 2022), under the assumption that this value
246 can represent the baseline vaccination rate (not influenced by the current level of omicron prevalence or
247 severity) before the omicron wave. Thus, we found $F_{10} = 0.0029$. We assumed a lower (10%) rate for
248 mandatory booster vaccination rate, $F_{20} = 0.9 * 0.0029 = 0.00261$, compared to the mandatory primary
249 series vaccination rate. We iteratively increased the mandatory testing rates, T_{10} and T_{20} starting from
250 0.0025 (average proportion of reported daily tested people prior to February 01, 2022), with the intention
251 of including the rate for people who can undergo testing at home, to achieve a best fit to the data. The
252 process resulted in $T_{10} = T_{20} = 0.03$. Assuming substantial number of people can get tested (both at home
253 and health centers) we fixed the value of T_{\max} to be 0.5. At the beginning of a vaccination campaign, the
254 cumulative number of vaccinated individuals is assumed to grow linearly. The values for reactivity factors

255 in vaccination, \tilde{D}, \tilde{B} (in primary dynamics, in secondary dynamics) are chosen so that the vaccination
256 rate can represent an initial linear growth. We accomplished such a choice by iteratively plotting the
257 vaccination rate for different randomly chosen values of \tilde{D} and \tilde{B} in the interval $[1, 20]$. The bounds of
258 the interval are arbitrarily set to include a reactivity value (2.5) used in the study [14]. Thus, we found
259 $\tilde{D} = \tilde{B} = 5$. We assumed a similar pattern for reactivity parameters in testing rates, so that $D = B = 5$.
260 The initial conditions are fixed by the data as follows: as of Feb 01, 2022, we assumed 85% of the total
261 population (44,365,186 out of 51,815,808) gained immunity from prior infection/vaccination and were
262 partially susceptible with waning immunity over time. Therefore, they were initially assigned to S_2 or
263 S_3 classes. Assuming a few of them get immunity through infection only [32], we distributed them as
264 about 90% are in S_2 and 10% in S_3 . Therefore, $S_2(0) = 40,000,000, S_3(0) = 4,365,186$. Based on the
265 initial population distribution (85% in secondary dynamics and 15% primary dynamics), we used the same
266 distribution for the initial conditions for infected and vaccinated compartments in both dynamics. For
267 example, from the data, the number of new vaccinated people on February 01, 2022 was 3,323. Therefore,
268 85% of these people are in V_2 (most of this is booster vaccination), and the remaining are in V_1 . That is,
269 $V_1(0) = 431$ and $V_2(0) = 2891$. Similarly, the initial conditions for tested compartments, which are daily
270 new cases, became $I_{T1}(0) = 2634$ and $I_{T2}(0) = 17632$. According to the study [33] it was assumed that
271 the number of exposed cases is 20 times the number of symptomatic cases. Therefore, the total number of
272 exposed people is assumed to be 405,339, which is distributed as $E_1(0) = 52,694$ and $E_2(0) = 352,645$.
273 According to the surveillance data of South Korea [32] 80% of exposed people become symptomatic and
274 20% become asymptomatic. Therefore, we set $A_1(0) = 0.2 * E_1(0) = 10,538, I_1(0) = 0.8 * E_1(0) = 42,155$
275 and $A_2(0) = 0.2 * E_2(0) = 70529, I_2(0) = 0.8 * E_2(0) = 282,116$. From Our World in Data, we used
276 the number people in the ICU on February 01, 2022 as an estimate for the initial population in the
277 hospital; therefore, $H(0) = 203$. The initial condition for the death compartment is, $D(0) = 15$, that is,
278 the number of death on February 01, 2022. We assumed recovered individuals to be $R(0) = 200$, more
279 than 10 times the number of deaths. This reflects that many more people recover from the disease after
280 experiencing mild illness due to their immunity. Finally, the rest of the population is placed in the S_1
281 compartment. *i.e.* $S_1(0) = N(0) - \sum_i Z_i(0)$, where Z_i represents all compartments in the model except S_1
282 and D . As for the information indices, we set their initial conditions at the equilibrium [14]: *i.e.*, $\mathcal{V}(0) =$
283 $k(I_1(0) + I_2(0) + I_{T1}(0) + I_{T2}(0) + H(0))/N_0$, $\mathcal{N}(0) = k(d_1(I_1(0) + I_2(0)) + d_2H(0) + H(0))/N_0$.

284

285 (ii) *Model fitting with South Korea COVID-19 data*

286

287 We fitted the model (10) to the cumulative daily cases, daily vaccination, and daily death data for the time
288 period from February 01, 2022 to May 31, 2022. We fit our model and conducted numerical simulations
289 to the highest peak of the omicron wave to evaluate how intervention scenarios and information param-
290 eters can influence the peak of the epidemic. The fitting process is accomplished by a Python built-in
291 curve fitting function called *curve_fit* (Nonlinear least squares optimization method) [34]. In general, this
292 method identifies the best parameter values by minimizing the sum of squared errors between the model
293 output and the data sets. For our model, there are four parameters to be estimated: transmission rates
294 in primary and secondary dynamics (β_1 and β_2), information coverage (k), and testing modification of
295 asymptomatic individuals (ξ).

296

297 The result of the fitting is displayed in Figure 2. The model best approximates the cumulative daily
298 cases (panel a) and slightly overestimates the death data (panel c). Although, the final cumulative death
299 data approximation is close to the observed data. The cumulative vaccination data follows some irregular
300 patterns as compared to the daily cases and death data. The model approximation to the cumulative
301 vaccination data changes over time (it slightly underestimates, or overestimates, panel b). The parameter
302 descriptions and their baseline values are displayed in Table 1.

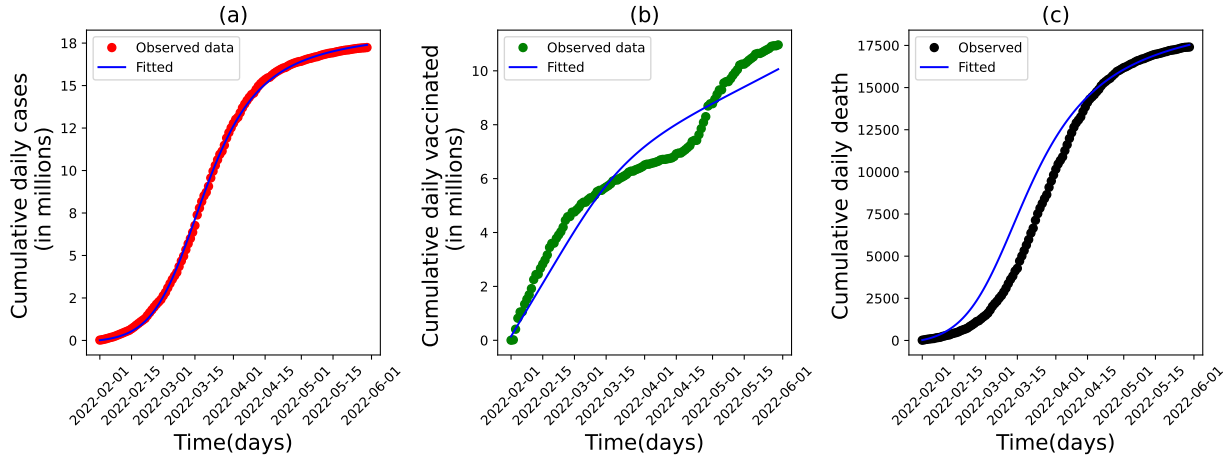

Figure 2: Result of the model fitting to South Korea’s COVID-19 epidemic data. The data represents the cumulative observed daily cases (in panel a), vaccination (in panel b) and death (in panel c). The time frame is from February 01, 2022 to May 31, 2022. The blue curve shows the approximation by the model (10). The approximation for a number of cases is obtained by adding a number of individuals in I_{T1} and I_{T2} classes (who are tested positive). Similarly, the estimated number of vaccinations is obtained by summing the number of individuals in V_1 and V_2 classes. The initial conditions used for daily cases, daily vaccination and daily death are $V_1(0) + V_2(0) = 3322$, $I_{T1}(0) + I_{T2}(0) = 20266$ and $D(0) = 15$, respectively.

303 In Figure 3, we displayed the time series of daily cases of observed data (green scattered points), the
 304 approximation by the model when voluntary vaccination and testing is considered (purple curve) and
 305 not considered (blue curve). The latter case is obtained by setting the reactivity parameter values to
 306 zero ($D = B = \tilde{D} = \tilde{B} = 0$). We call a result of the model a *responsive case (base case)*, when the
 307 vaccination and testing rates are ruled by both mandatory and voluntary rates (people’s vaccination
 308 choice is affected by the level of the disease status) and *unresponsive cases* when these rates are ruled
 309 only by the mandatory rates (level of prevalence or severity does not affect the individual’s vaccination
 310 and testing decision). The result in Figure 3 shows that the model best estimates the observed daily cases
 311 when voluntary vaccination and testing are considered. When the voluntary part is not considered, the
 312 model underestimates the number of daily cases. For instance, the peak of active is lower (by 33%) in
 313 the unresponsive case compared to the base case (responsive case) (*i.e.*, a peak decrease from 366280 to

314 246389).

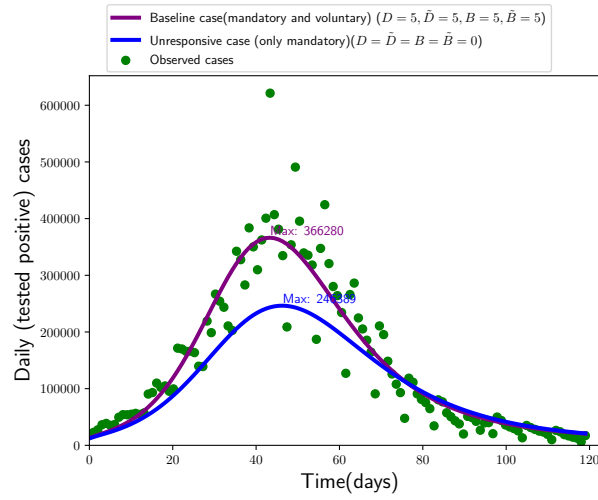

Figure 3: A comparison of observed daily cases (green scattered plot) with model approximation of daily cases when the vaccination and testing rates are ruled by both mandatory and voluntary rates (purple curve) and when these rates are ruled by only mandatory rate (blue curve).

Param.	Description	Baseline value	Reference
π	Recruitment rate to susceptible class	1710 indiv./day	See Sec. 4(i)
μ	Natural death rate	3.301×10^{-5}	See Sec. 4(i)
ϵ	Reciprocal of latency period	0.33	[35]
ψ	Reduced infection rate for asymptomatic class	0.5	[36, 31]
τ	Proportion of individual that become symptomatic	0.8	[32]
ρ	Recovery rate for symptomatic & asymptomatic class	1/14	[35]
ρ_t	Recovery rate for tested class	1/10	Assumed ($\rho_t > \rho$)
ρ_h	Recovery rate for hospitalized class	1/10	Assumed ($\rho_t = \rho_h$)
η_1	Primary series vaccine effectiveness	0.71	[19]
η_2	Primary series vaccine effectiveness after 6 months	0.41	[18]
η_3	Booster Vaccine effectiveness	0.85	[37]
η_4	Effectiveness of immunity due to prior infection after 6 months	0.46	[18]
ϕ	Transition from Recovery and primary vaccination classes to secondary dynamics	1/180	[18]
h_1	Hospitalization for tested class (primary dynamics)	0.0012	[38]
h_2	Hospitalization for tested class (secondary dynamics)	0.000312	[18]
F_{\max}	Maximum vaccination rate	0.027	See Sec. 4(i)

F_{10}	Mandatory vaccination in primary dynamics	0.0029	See Sec. 4(i)
F_{20}	Mandatory vaccination in secondary dynamics	0.00261	See Sec. 4(i)
T_{\max}	Maximum testing rate	0.5	See Sec. 4(i)
T_{10}	Mandatory testing in primary dynamics	0.03	See Sec. 4(i)
T_{20}	Mandatory testing in secondary dynamics	0.03	See Sec. 4(i)
a	Inverse of the average information delay time	0.33	Assumed
\tilde{D}	Reactivity factor to voluntary testing (primary dynamics)	5	See Sec. 4(i)
\tilde{B}	Reactivity factor to voluntary vaccination (primary dynamics)	5	See Sec. 4(i)
B	Reactivity factor to voluntary testing (secondary dynamics)	5	Assumed $B = \tilde{B}$
D	Reactivity factor to voluntary vaccination (secondary dynamics)	5	Assumed $D = \tilde{D}$
θ	Reduced reactivity to the information in secondary dynamics	0.5	Assumed
δ	Percentage of positively tested people who quarantine	80%	Assumed
$\alpha_i, i =$ 1, 2	Weight given to the information	0.5	Assumed
d_1	Disease-induced death rate for symptomatic class	0.000071	Iteratively chosen
d_2	Disease-induced death rate for hospitalized class	0.000073	Iteratively chosen
β_1	Transmission rate (primary dynamics)	0.67	Fitted
k	Information coverage	0.5046	Fitted
β_2	Transmission rate (secondary dynamics)	0.39	Fitted
ξ	Testing modification for asymptomatic class	0.99	Fitted

Table 1: Parameters with their description and baseline values.

315 With the parameter values in Table 1, the estimated value of the effective reproduction number is
 316 $R_e = 0.64$. This value is the sum of the effective reproduction number in primary dynamics and sec-
 317 ondary dynamics, being 0.07 and 0.57, respectively. The basic reproduction number is estimated to be
 318 8.43. This value falls in the interval [5.5, 24], which contains the basic reproduction values for omicron
 319 virus that are reported in different studies [39]. The effective reproduction number we found is smaller
 320 than the values reported in some other studies [40, 41]. In [40], the mean reproduction number for the
 321 omicron variant during the first local outbreak in South Korea was estimated to be 1.72. Another study
 322 [41] estimated the effective reproduction number for the omicron variant as 1.3 during the time period
 323 November 25, 2021 – January 08, 2022. A review paper [39] showed that the effective reproduction num-
 324 ber for omicron reported in different studies fall between 0.88 and 9.4. The variation in the reproduction

325 number across different studies can be attributed to several factors, such as the time and locations of
326 the studies, exposure patterns, vaccine coverage, and the levels of immunity in the affected populations
327 . In our model, a key reason for the low effective reproduction number is the initial population distri-
328 bution, where 85% of the population is initially immune, with vaccine efficacy ranging from 41% for the
329 primary series vaccination to 85% for booster vaccination. For instance, if the booster vaccination efficacy
330 decreases to 75% (10% lower than the base case, 85%), the effective reproduction number increases to
331 0.9989.

332

333 *(iii) Stability region for the disease-free equilibrium in (F_{10}, F_{20}) plane*

334

335 From a vaccination and testing perspective, the parameters that drive the effective reproduction number
336 are those related to the mandatory vaccination and testing rates $(F_{10}, F_{20}, T_{10}, T_{20})$. Thus, by varying
337 these rates, one can achieve the condition $R_e < 1$ (stability of the disease-free equilibrium). Since varying
338 the mandatory testing rates, T_{10} and T_{20} , does not modify R_e beyond one, we vary the mandatory
339 vaccination rates in primary dynamics (F_{10}) and secondary dynamics (F_{20}) here to depict their impact
340 on the stability region. The result is shown in Figure 4 where the shaded region is the region in which
341 $R_e > 1$ (showing instability of the disease-free equilibrium) and the non-shaded region is where $R_e < 1$
342 (showing stability of the disease-free equilibrium). One can set threshold values for these parameters, given
343 that the other parameter values in the model are kept constant. For example, when the first mandatory
344 vaccination rate - F_{10} in the primary dynamics is less than 0.0005 or the mandatory booster vaccination
345 rate - F_{20} is less than 0.00016, then $R_e > 1$ regardless of the wide variation of the primary series or
346 boosting vaccination rate, respectively. However, if $F_{10} > 0.00075$ and $F_{20} > 0.0002$, then the disease
347 spread can be controlled over time ($R_e < 1$). The boundary of the regions ($R_e = 1$) in the figure is where
348 the stability of the disease-free equilibrium changes.

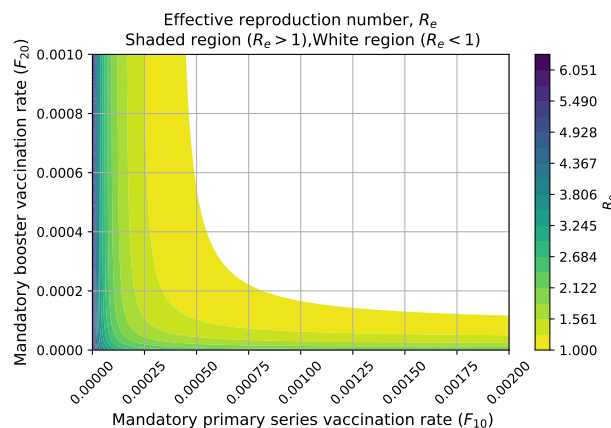

Figure 4: Value of the effective reproduction number R_e by varying the mandatory primary series vaccination rate, F_{10} and mandatory boosting vaccination rate, F_{20} . The shaded region is a region where $R_e > 1$ and the white region is where $R_e < 1$. Other parameter values are fixed to their baseline values, as in Table 1.

349 5 The role of behavior-related parameters

350 In this section, we perform numerical simulations to investigate the effect of parameters related to vol-
 351 untary vaccination and testing on the disease dynamics. Except the varying parameters in the plots, all
 352 other parameter values are fixed as in the Table 1.

354 (i) Impact of changes of information parameters on active cases peak

355
 356 Here, we address the effect of changes in information coverage, information delay and reactivity factors
 357 on active cases peak. Active cases indicate the number of infectious individuals who are not detected
 358 (tested), those are in A_1, A_2, I_1 and I_2 . Figure 5 illustrates that information coverage is the key driver
 359 among other parameters. The maximum active cases is more sensitive to the information delay when the
 360 information coverage is larger than the base line value ($> 51\%$). The minimum peak of active cases is
 361 attained when there is a higher information coverage ($k > 80\%$) and shorter time delay ($T \leq 3$ days), see
 362 Figure 5 panel (a). For example, when $k = 0.9$ and $T = 3$ days the peak of active cases is around 4.3
 363 million, where as when $k = 0.1$ and $T = 30$ days the peak is almost double as 8.2 million. In Figure 5

364 panels (b) and (c) we assumed reactivity to prevalence in vaccination, \tilde{D} , and testing, D to vary equally.
 365 A similar assumption is made for reactivity to severity parameters: in vaccination (\tilde{B}) and testing (B).
 366 The results in Figure 5 panels (b) and (c), show that the peak of active cases is more sensitive to an
 367 individual’s reactivity to information about prevalence than to information about severity. When people
 368 react to the prevalence, D/\tilde{D} is less than 5 (base value); increasing information coverage does not affect
 369 the active cases peak, Figure 5 panel (b). This demonstrates that prompt public response is an essential
 370 factor in addition to the government’s efforts to achieve high information coverage in a timely way to
 371 reduce the epidemic peak.

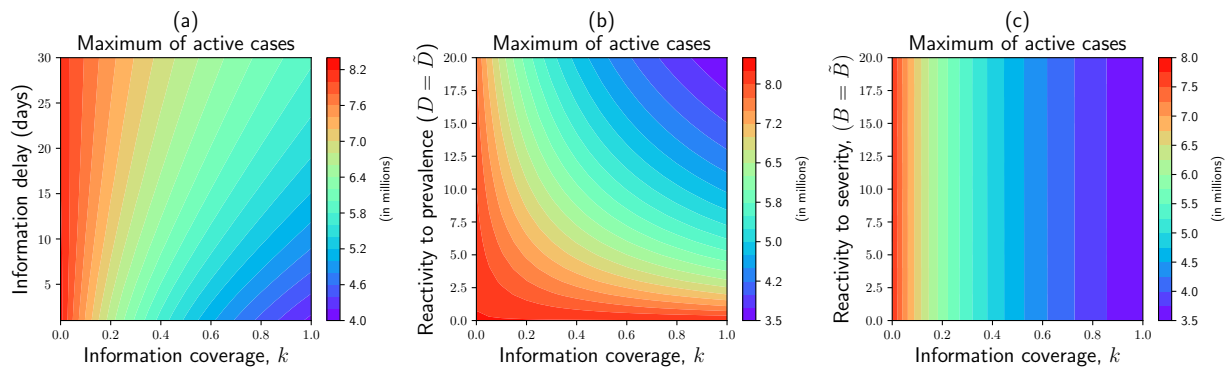

Figure 5: Contour plot for maximum (peak) of active cases by varying information coverage (k) with: information delay time ($\frac{1}{a}$ days), panel (a) , people’s reactivity to prevalence information (assumed to vary equally, $D = \tilde{D}$, in vaccination and testing rates), panel (b), reactivity to severity information (assumed to vary equally, $B = \tilde{B}$, in vaccination and testing rates), panel (c). Active cases represent a number of infectious individuals who are undetected (not tested) ($A_1 + A_2 + I_1 + I_2$).

372 (ii) *Impact of change in level of reactivity to the information by partially immune population on the dy-*
 373 *namics of active cases*

374

375 Here, we will explore how the reduction in reactivity to information among partially immune individuals,
 376 θ , compared to susceptible ones, impacts the dynamics of the disease, particularly the number of active
 377 cases. At its base line value, $\theta = 0.5$ (50% reduction), the active cases peak becomes 5.5 million, we call
 378 this as the base active case peak. The lowest active cases peak is achieved when partially immune people

379 react to information the same level as the susceptible ones ($\theta = 1$), which is 16% less than the base active
380 cases peak and 40% less than the active cases peak when partially immune people not reacting to the
381 information ($\theta = 0$), see Figure 6. When $\theta = 0.75$ (25% reactivity reduction by immune people compared
382 to the susceptible individuals), the peak decreases by 9% compared to the base case. In general, the
383 active cases peak lowers as partially immune people behave more similarly to non-immune persons (*i.e.*, θ
384 changes from 0 to 1).

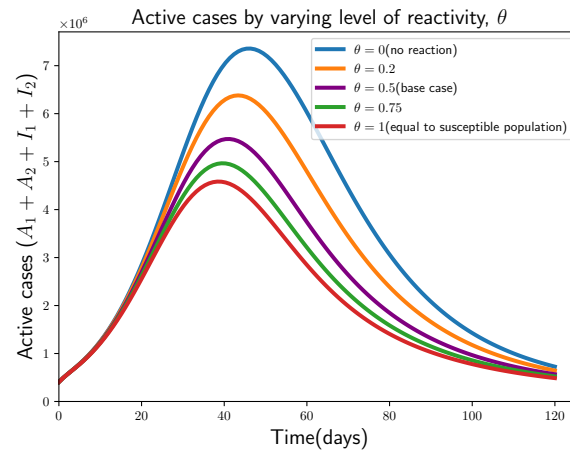

Figure 6: Time series of active cases, with varying levels of reactivity to the information by partially immune people (people in secondary dynamics) relative to susceptible (people in primary dynamics). The baseline value for the level of reactivity to information by susceptible individuals is 5.

385 (iii) *Impact of behavior adaptation between immune and susceptible populations on dynamics of vaccina-*
386 *tion and testing rates, and active cases.*

387

388 The compliance of individuals with protective measures may vary over the course of a pandemic [16, 17],
389 especially in scenarios where the disease persists despite widespread vaccination, as seen in the case
390 of COVID-19. In such circumstances, it becomes essential to analyze the dynamics by accounting for
391 behavioral disparities among sub-populations and their different risk perceptions. We accounted for the
392 disease status information (prevalence and severity) that can influence the sub-populations' (susceptible
393 and partially immune) risk perception and compliance with vaccination and testing (*i.e.*, susceptible

394 people may prioritize prevalence while partially immune people may prioritize the severity (representing
395 a change in risk perception [17]), and this phenomenon will impact their compliance to vaccination and
396 testing differently). We assessed the consequence of vaccination and testing rates and the epidemic burden
397 (number of active cases) by applying different weights (using α_1 and α_2 for prevalence and $1 - \alpha_1$ and
398 $1 - \alpha_2$ for severity, respectively) between two information (prevalence and severity) among the susceptible
399 and partially immune populations. We examine the following three scenarios to demonstrate the impact
400 of the weight individuals place on the information about prevalence or severity in the two dynamics, i.e.,
401 which information people care about when making a decision to be tested or vaccinated:

- 402 1. **Scenario 1 (base case):** Susceptible (in primary dynamics) and partially immune (in secondary
403 dynamics) people equally care about both severity and prevalence, given by $\alpha_1 = 0.5, \alpha_2 = 0.5$ (the
404 base case) for taking a decision to vaccinate or test regardless of their immune status.
- 405 2. **Scenario 2:** Both susceptible and partially immune people prioritize prevalence information, given
406 by $\alpha_1 = 0.9, \alpha_2 = 0.9$.
- 407 3. **Scenario 3:** Susceptible people prioritize prevalence information and partially immune people
408 prioritize severity, given by $\alpha_1 = 0.9, \alpha_2 = 0.1$.

409 The results of scenario 3 (Figure 7 panel c) show that vaccination and testing rates are the greatest,
410 while the vaccination and testing rates of the partially immune population are the lowest. As susceptible
411 populations rapidly become partially immune populations with the model simulations over time, the lower
412 vaccination and testing rates of partially immune populations (second dynamics) resulted in a higher (17%)
413 peak of active cases compared to the base case (scenario 1, Figure 7 panel a). On the other hand, the
414 results of scenario 2 (Figure 7 panel b) show that the vaccination and testing rates of both susceptible and
415 partially immune populations are slightly higher than the base case, as they react more from the preva-
416 lence signal to vaccination and testing than base case (90% vs 50%), resulting in a lower (22%) peak of
417 the active case than the base case. A shift in prioritization from prevalence to severity information among
418 partially immune individuals (from 90% prevalence and 10% severity to 90% severity and 10% prevalence)
419 while susceptible individuals remain at the same risk perception (90% prevalence and 10% severity) can
420 result in an increase of active cases peak by 50% (from 36 million to 44 million) compared to the case
421 where both (partially immune and susceptible individuals) have higher weight of prevalence than severity
422 (90% prevalence and 10% severity), comparing Figure 7 panel b and c (shift from scenario 2 to scenario 3).

423

424 We examined the above scenarios based on theoretical assumptions because there is a lack of data regarding
425 how people prioritize information for decisions. The numerical simulation results suggest that differences
426 in risk perceptions among sub-populations may result in different voluntary decisions to vaccination and
427 testing and levels of prevalence may peak consequently. Therefore, the overall epidemic burden is the result
428 of the relative size and distribution of sub-populations and their different risk perceptions and associated
429 care-seeking behaviors. A rise in epidemic can lead to increased voluntary care-seeking behaviors, which
430 can reduce the prevalence. This reduced prevalence can decrease voluntary care-seeking behavior, which
431 in turn can increase the prevalence. Such feedback loop in the model (10) can help us understand a
432 dynamic interplay between disease status and population behaviors. Future work should explore fitting
433 the proposed model to the course of epidemic waves with the seroprevalence and care seeking data from
434 survey, where participants are queried in different time periods of the pandemic about their immune
435 status, risk perception, and contact patterns or care seeking (vaccination and testing) behaviors. Such
436 data can be used to improve the estimates of some of the parameters in the behavior adaptation metrics
437 introduced in this paper.

It is made available under a [CC-BY-ND 4.0 International license](https://creativecommons.org/licenses/by-nd/4.0/).

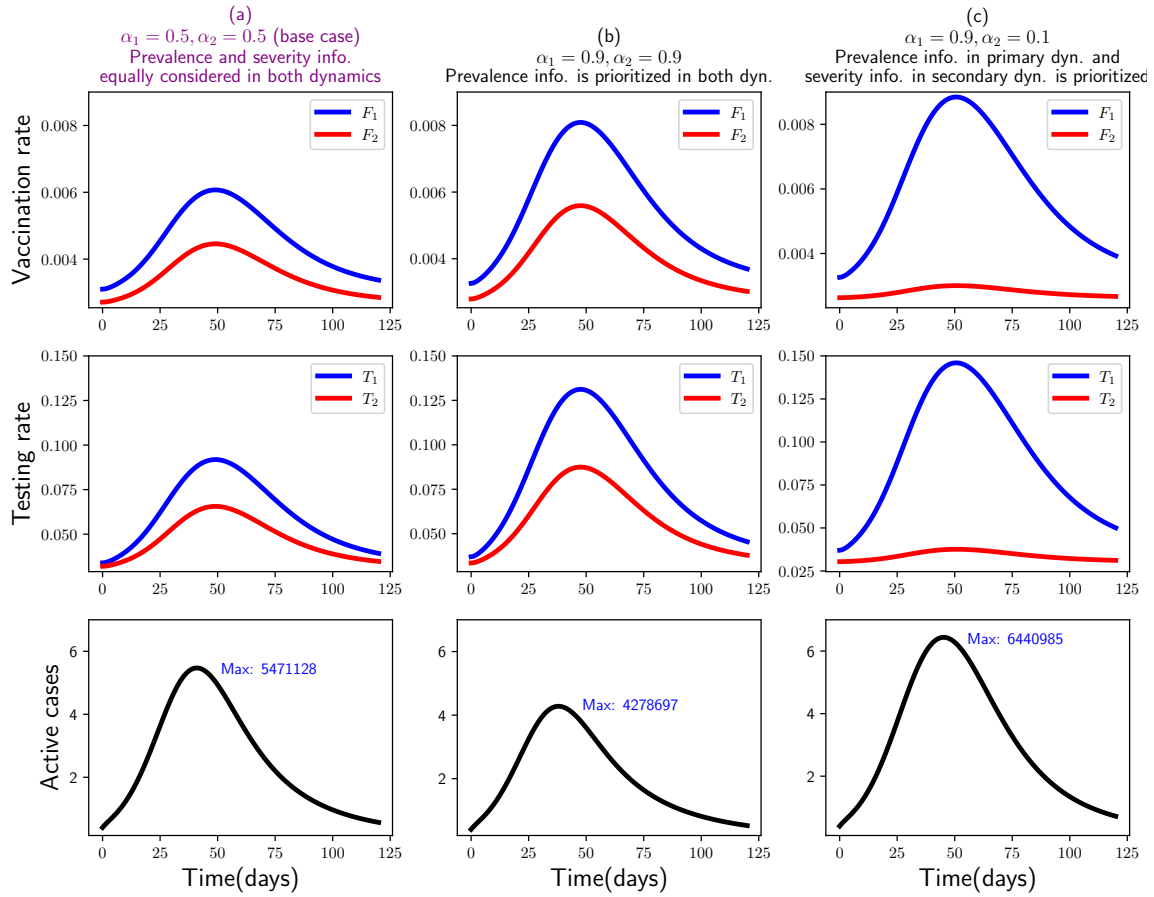

Figure 7: The dynamics of vaccination rate (in primary dynamics F_1 , in secondary dynamics F_2), first row, Testing rate (in primary dynamics T_1 , in secondary dynamics T_2), second row, and Active cases ($A_1 + A_2 + I_1 + I_2$), (third row) under three scenarios: first, people in both dynamics equally care about information regarding prevalence and severity, panel (a), second, people in both dynamics care about prevalence than severity information, panel (b), third, people in primary dynamics care about prevalence than severity whereas people in secondary dynamics care about severity than prevalence, panel (c). The parameters α_1 and α_2 indicates the weight given to the prevalence information in primary and secondary dynamics respectively. The remaining (complementary) weights $1 - \alpha_1$ and $1 - \alpha_2$ are assigned to severity information in the respective dynamics.

438 *(v) Sensitivity of cumulative incidence to parameters.*

439

440 In this subsection we conducted a comprehensive sensitivity analysis using a tornado plot, shown in Figure
441 8, to show the effect of some selected parameters on the cumulative incidence for a time period of four
442 months (February 01, 2022 – May 31, 2022). The selected parameters are classified as:- classical param-
443 eters: transmission rate, infectiousness of asymptomatic individuals, proportion of isolated individuals,
444 mandatory vaccination and testing rates, and the behavior related parameters: such as information cov-
445 erage, information delay, information prioritization, level of reduction in reactivity. For the sensitivity
446 analysis purpose, we set a low and high value for each of these parameters based on the baseline values.
447 The low and high values are fixed to be 50% less than the base values ($0.5 \times$ base value) and 50% higher
448 than the base value ($1.5 \times$ base value), respectively. In Figure 8 the vertical line at the center of the
449 tornado plot represents the cumulative incidence corresponding to the case where all parameter values
450 are fixed at their baseline value, as in Table 1. The effect of the parameters on the cumulative incidence
451 is represented by the length of the bars extending from the base case (center), depending on their low
452 and high values. The findings indicate that, out of all the parameters considered in this analysis, the
453 transmission rate in secondary dynamics, proportion of isolated individuals, and the testing rates are the
454 top drivers of cumulative incidence change, whereas behavioral parameters (such as reactivity to preva-
455 lence information, information coverage, reduced reactivity by partially immune people, and prevalence
456 information prioritization by immune people) also have a significant impact. Comparing the sensitivity
457 of parameters in the primary and secondary dynamics, the parameters in the secondary dynamics (e.g.,
458 Transmission rate secondary dynamics β_2 , prevalence prioritization by partially immune people, α_2) are
459 more sensitive to cumulative incidence than parameters in primary dynamics. This increased sensitivity
460 to parameters in secondary dynamics is due to the large proportion of the initial population in secondary
461 dynamics and the rapid progression from primary to secondary dynamics due to the model formulation.

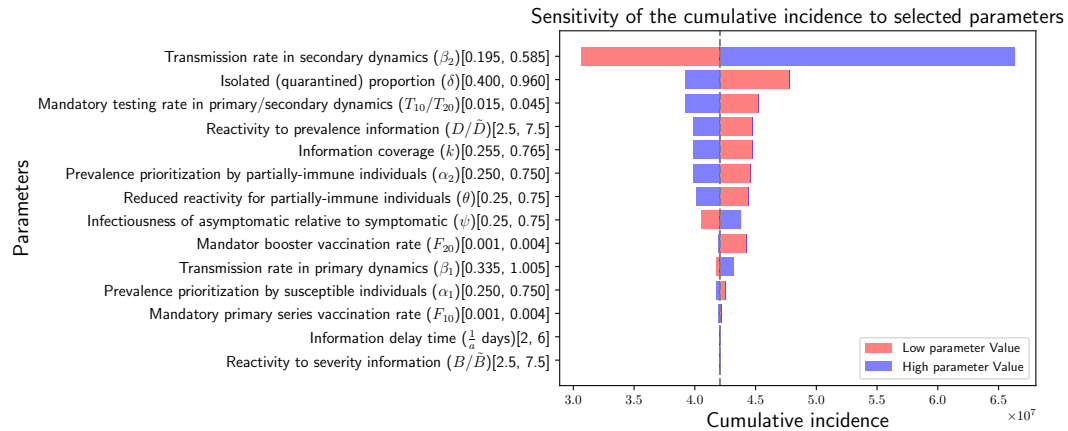

Figure 8: Tornado plot showing the sensitivity of parameters to cumulative incidence over four months (February 01, 2022 - May 31, 2022). The red and blue bars show the cumulative incidence corresponding to a low ($0.5 \times$ base value) and high ($1.5 \times$ base value) values of the parameters, respectively. The center vertical line represents the cumulative incidence when all parameters are fixed at their baseline values. The numbers in the closed bracket for each parameters show the low and high values used for sensitivity analysis: [low, high]. The baseline values for the parameters are as in the Table 1.

462 6 Discussion

463 In this study, we developed a novel behavior-epidemiology model representing the transmission of COVID-
 464 19 that takes into account the behavioral differences among people who are partially immune and those
 465 who are not-immune (susceptible) in seeking vaccination and testing [15, 16, 17]. The model outputs were
 466 fitted to observed cumulative COVID-19 cases, vaccination and mortality data during the Omicron wave
 467 (February 01, 2022 – May 31, 2022) in South Korea. Unlike other behavioral models that employ the
 468 information index approach with a single type of information such as disease prevalence [6, 8, 12, 13, 14],
 469 our model takes into account that people may have different risk perception (prevalence and severity) and
 470 behavior responses (vaccination and testing) across different subgroups by immune status. The overall
 471 impact on the prevalence peak in our behavioral model is the result from the non-linear relationship
 472 between the number of detected cases that can be information signals to promote voluntary vaccination
 473 and testing (decreasing prevalence) and the number of undetected cases that can keep contributing to the

474 transmission (increasing prevalence).

475

476 Our stability analysis shows that even the majority (85%) of the population is partially immune, if manda-
477 tory vaccination rates decrease below the threshold values (as shown in the yellow frontier line in Figure
478 4) R_e can be greater than one, and the impact of voluntary behavior parameters become more important.
479 For example, if $R_e = 3.17$ (obtained by setting $F_{10} = 10^{-4}$, $F_{20} = 10^{-6}$, reflecting almost no mandatory
480 booster vaccination (equivalent to 44 people getting mandatory booster vaccination per day, out of the
481 initial population in S_2 and S_3) and 600 daily mandatory primary series vaccination, out of the initial
482 number of people in S_1), the cumulative incidence becomes 43.7 million. This cumulative incidence can
483 be reduced by 20% to 53% by enhancing the voluntary vaccination and testing, which can be achieved
484 by increasing the behavior parameters related to the voluntary vaccination and testing rates from their
485 baseline value— For example, by increasing the level of reactivity of partially immune individuals from the
486 baseline value of 50% to 95% (showing an almost equal level of reactivity as the susceptible individuals),
487 the cumulative incidence can be reduced by 20% (35 million). In addition to this increment, if we increase
488 all other behavioral parameters related to voluntary vaccination and testing rates to some possible maxi-
489 mum value (information coverage (baseline 0.51), prevalence prioritization by susceptible people (baseline
490 0.5) to 0.95, reactivity to information (baseline 5) to 10) the cumulative incidence can be reduced by 53%
491 (20 million).

492

493 Our simulation results indicate that the peak number of active cases can be reduced by up to 16% when
494 partially immune individuals react to information at the same level as susceptible individuals. This is
495 in comparison to a scenario where partially immune individuals have a reduced reactivity to information
496 (50% of the reactivity level of susceptible individuals). This suggests that responsiveness to protective
497 measures by individual immune status can substantially influence the level of future incidence. The result
498 related to information prioritization by susceptible and partially immune individuals showed that over
499 time, if partially immune individuals prioritize severity over prevalence (altering their risk perception),
500 the peak of active cases can increase by up to 17% and 50% compared to when they equally (50% to preva-
501 lence and 50% to severity) prioritize both information (base case) and when they prioritize prevalence
502 over severity (90% to prevalence, 10% to severity), respectively. This result shows that when public risk
503 perception changes (e.g., toward severity over prevalence) over the course of the pandemic with multiple
504 variants of epidemic waves, the required target of mandatory vaccination or testing may change, and the

505 public health efforts to control disease may require additional endeavors to reduce the prevalence peak.
506 Furthermore, the variation in prevalence peak based on the risk perception by susceptible and partially
507 immune people underscores the need for further research into how these groups of people perceive disease-
508 related information.

509

510 The sensitivity analysis result show that the key drivers influencing cumulative incidence are the trans-
511 mission rate in secondary dynamics and the proportion of isolated (quarantined) individuals among those
512 tested. This demonstrates that non-pharmaceutical interventions such as social distancing and mask-
513 wearing remain important to control the spread of the virus besides ongoing testing and vaccination.
514 Moreover, the behavior-related parameters (i.e., reactivity to prevalence information, information cover-
515 age, and prevalence information prioritization) substantially contribute to cumulative incidence change,
516 even greater than the mandatory booster vaccination. These results suggest potential disease control
517 mechanisms in two aspects: one is from the government side by increasing information coverage (e.g., by
518 avoiding under reporting, which can be achieved by increasing case detection), and the other is from the
519 population side by an increased level of reactivity and risk perception among partially immune individ-
520 uals, comparable to that of susceptible people (which enhances the vaccination and testing rates among
521 immune people). In general, the sensitivity results suggest that, when the majority people are initially
522 immune, it is important to consider behavior-related parameters as they can influence total disease burden
523 more significantly than those other standard measures, for example, mandatory vaccination.

524

525 There may be various other metrics that could induce behavior changes during a pandemic like COVID-19.
526 For example, authors in a recent study [7] developed a behavioral epidemiology model aiming at assessing
527 the impact of human behavior changes due to factors such as disease-related information received from
528 members of the other group, the level of symptomatic transmission in the community, the proportion of
529 non-symptomatic individuals in the community, the level of publicly available disease-induced mortality
530 information, and fatigue with adherence to control and mitigation interventions in the community, on
531 compliance behavior. One of their results shows that disease-induced mortality has a more significant
532 impact on behavior change compared to the level of symptomatic transmission. This finding somewhat
533 contradicts the results from our model, where the influence of symptomatic infection (disease prevalence)
534 levels is a key driver to the peak of the active cases, rather than the influence of disease severity (measured
535 by the level of deaths and hospitalizations). This discrepancy might be attributed to, for example, the

536 fact that their study examined the impact of each different model output as described above as a signal
537 to change adherence behaviors among the susceptible population in the early stage of the pandemic (thus,
538 most people are susceptible yet) and fit the model to the relatively high mortality rate under the original
539 SARS-CoV-2 virus variant compared to the case during Omicron variants, which resulted in mortality
540 being a driving factor of adherence behavior. In our study, we accounted for behavior adaptation by the in-
541 dividual history of previous exposure and vaccination and explored differing individual reactivity and risk
542 perception/weight by the type of information (between prevalence and severity) and immune status and
543 fitted the model to data during the Omicron epidemic peak (of which the virus variants are characterized
544 by high transmission but low severity [42]). Overall, these findings can be complementary to understand
545 a population behavior dynamics in the early stage of the pandemic, where the adherence behavior of
546 susceptible populations can be a function of various aspects of model outputs, and in the later stage of a
547 pandemic, where care seeking behavior can differ by population immunity status and their risk perception.

548

549 Our study has some limitations. First, in the information index approach, there is a lack of enough empiric
550 data to validate the functional forms (in equations (2), (3), (4) and (5)) used for modeling information-
551 dependent vaccination and testing rates. Thus, we took several steps to address this issue: (i)- We
552 iteratively calibrated certain parameters, such as individuals' reactivity to prevalence or severity infor-
553 mation, to ensure that the voluntary vaccination or testing rates reflected the observed data with slower
554 initial growth for the cumulative number of vaccinated and tested individuals, which is typical at the start
555 of a vaccination or testing campaign [30]. (ii)- We also conducted various sensitivity analyses to examine
556 whether the results were robust by changing the input parameter values. Second, our model accounts for
557 the driving forces for vaccination and testing decisions driven by individuals' risk perceptions about the
558 disease status in the population. However, other factors can influence testing and vaccination decisions,
559 such as access to health care systems, testing procedures, perceptions or beliefs related to vaccine side
560 effects, knowledge of COVID-19 symptoms, etc. [43, 44, 45]. Further more, it is also possible that the
561 individual reactivity to prevalence and severity may differ by other individual characteristics such as age
562 group as well (besides the immune status); in other words, in communities where the majority of people
563 are young, severity information may not be as concerning since COVID-19 deaths predominantly affect
564 older individuals [46]. Conversely, if the majority of the population is old, the average weight of risk per-
565 ception in the population toward death may be greater than the infection. Indeed, it may not be possible
566 to parameterize all the possible factors and individual heterogeneity that influence willingness to test-

567 ing/vaccination and behaviors in a single model. Moreover, decision-makers are faced with the daunting
568 task of interpreting model predictions while simultaneously estimating how behavioral responses should
569 alter predictions. Despite the given complexities and uncertainties, these estimates might be enhanced by
570 explicitly modeling behavioral responses (i.e., willingness to vaccination as a function of risk and benefit
571 of vaccination) to interventions rather than simply adjusting any assumed constant parameters. Accord-
572 ingly, our study findings demonstrate the relatively significant impact of behavioral factors on the overall
573 cumulative incidences and thus emphasize the importance of future efforts to collect empiric data and
574 identify driving factors on risk perception and information prioritization among immune and susceptible
575 individuals. Incorporating these behavioral aspects into transmission models may become increasingly
576 useful and important as the epidemic continues and people's behaviors change.

577

578 In summary, this study contributes to the field of epidemiological modeling by illustrating the complex
579 interplay between information, human behavior, and immune status and their impact on disease trans-
580 mission. To our knowledge, our study is the first attempt to apply an information index with different
581 disease-relevant information (prevalence and severity) among people with different immune statuses and
582 to fit such a model to real-world data. Future studies may further evaluate interplay between various indi-
583 vidual status (immunity/age/care seeking history), vaccination, testing and disease transmission, aiming
584 at providing optimal intervention strategies under evolving circumstances.

585

586 **Data Accessibility:** Numerical simulations were carried out in Python using standard algorithms. We
587 utilized the 'odeint' solver from 'scipy.integrate' for integrating the model system and employed 'pyplot'
588 for figure visualization. All necessary details for reproducing the results are provided in Section 4. The
589 study relies on official COVID-19 data from South Korea, sourced from Our World in Data [30]. The
590 codes and data used are uploaded to Dryad [47]. Use the following links to access them

591 Reviewer URL: https://datadryad.org/stash/share/_vm4gFgQ9uxMAFnSbGYLsD41b915anwnPKsO6W0YhpU

592 DOI: <https://doi.org/10.5061/dryad.wpzgmsbxp>

593

594 **Competing interest:** We declare that we have no competing interests.

595

596 **Funding:** This research was funded by the Infectious Disease Medical Safety Project, supported by the
597 Ministry of Health & Welfare, Republic of Korea (Grant Number: HG22C0094).

598

599 **Acknowledgements.** S.S.S., Y.J. and J.J. gratefully acknowledge the financial support provided by
600 the Ministry of Health & Welfare, Republic of Korea, through the Infectious Disease Medical Safety
601 Project (Grant Number: HG22C0094). B.B. acknowledges the auspices of Italian National Group for
602 Mathematical Physics (GNFM) of the National Institute for Advanced Mathematics (INdAM). B. B. also
603 acknowledges the support of EU funding within the Next Generation EU–MUR PNRR Extended Part-
604 nership initiative on Emerging Infectious Diseases (Project No. PE00000007, INF-ACT) and PRIN 2020
605 project (No. 2020JLWP23) "Integrated Mathematical Approaches to Socio–Epidemiological Dynamics".
606 We appreciate constructive comments and detailed editorial support from Bernard L. Cook, PhD, at
607 UConn Health.

References

- [1] Stephen M Kissler, Christine Tedijanto, Edward Goldstein, Yonatan H Grad, and Marc Lipsitch. Projecting the transmission dynamics of SARS-CoV-2 through the postpandemic period. *Science*, 368(6493):860–868, 2020.
- [2] Megan Scudellari. How the pandemic might play out in 2021 and beyond. *Nature*, pages 22–25, 2020.
- [3] Raffaele Vardavas, Pedro Nascimento de Lima, Paul K Davis, Andrew M Parker, and Lawrence Baker. Modeling infectious behaviors: the need to account for behavioral adaptation in COVID-19 models. *Policy and complex systems*, 7(1):21, 2021.
- [4] Zeting Liu, Huixuan Zhou, Ningxin Ding, Jihua Jia, Xinhua Su, Hong Ren, Xiao Hou, Wei Zhang, and Chenzhe Liu. Modeling the effects of vaccination, nucleic acid testing, and face mask wearing interventions against COVID-19 in large sports events. *Frontiers in Public Health*, 10:1009152, 2022.
- [5] Janoś Gabler, Tobias Raabe, Klara Röhrle, and Hans-Martin von Gaudecker. The effectiveness of testing, vaccinations and contact restrictions for containing the COVID-19 pandemic. *Scientific Reports*, 12(1):8048, 2022.
- [6] Bruno Buonomo. Effects of information-dependent vaccination behavior on coronavirus outbreak: insights from a SIRI model. *Ricerche di Matematica*, 69:483–499, 2020.
- [7] Binod Pant, Salman Safdar, Mauricio Santillana, and Abba Gumel. Mathematical assessment of the role of human behavior changes on sars-cov-2 transmission dynamics. *medRxiv*, pages 2024–02, 2024.
- [8] Bruno Buonomo and Rossella Della Marca. Effects of information-induced behavioural changes during the COVID-19 lockdowns: the case of Italy. *Royal Society open science*, 7(10):201635, 2020.
- [9] Ousmane Koutou, Boureima Sangaré, et al. Mathematical analysis of the impact of the media coverage in mitigating the outbreak of COVID-19. *Mathematics and Computers in Simulation*, 205:600–618, 2023.

- [10] Ashraf Adnan Thirthar, Hamadjam Abboubakar, Aziz Khan, and Thabet Abdeljawad. Mathematical modeling of the COVID-19 epidemic with fear impact. *AIMS Math*, 8(3):6447–6465, 2023.
- [11] Chao Zuo, Fenping Zhu, and Yuting Ling. Analyzing COVID-19 vaccination behavior using an SEIRM/V epidemic model with awareness decay. *Frontiers in Public Health*, 10:817749, 2022.
- [12] Bruno Buonomo and Rossella Della Marca. Oscillations and hysteresis in an epidemic model with information-dependent imperfect vaccination. *Mathematics and Computers in Simulation*, 162:97–114, 2019.
- [13] Bruno Buonomo and Rossella Della Marca. A behavioural vaccination model with application to meningitis spread in Nigeria. *Applied Mathematical Modelling*, 125:334–350, 2024.
- [14] Bruno Buonomo, Rossella Della Marca, and Sileshi Sintayehu Sharbayta. A behavioral change model to assess vaccination-induced relaxation of social distancing during an epidemic. *Journal of Biological Systems*, 30(01):1–25, 2022.
- [15] Toki Bolt, Amanda Tufman, Laura Sellmer, Kathrin Kahnert, Pontus Mertsch, Julia Kovács, Diego Kauffmann-Guerrero, Dieter Munker, Farkhad Manapov, Christian Schneider, et al. Changes in behavior after vaccination and opinions toward mask wearing: Thoracic oncology patient-reported experiences during the COVID-19 pandemic. *Clinical Medicine Insights: Oncology*, 16:11795549221123618, 2022.
- [16] Rafael Goldszmidt, Anna Petherick, Eduardo B Andrade, Thomas Hale, Rodrigo Furst, Toby Phillips, and Sarah Jones. Protective behaviors against COVID-19 by individual vaccination status in 12 countries during the pandemic. *JAMA network open*, 4(10):e2131137, 2021.
- [17] Jayson S Jia, Yun Yuan, Jianmin Jia, and Nicholas A Christakis. Risk perception and behavior change after personal vaccination for COVID-19 in the USA. *PsyArXiv*, 2022.
- [18] Niklas Bobrovitz, Harriet Ware, Xiaomeng Ma, Zihan Li, Reza Hosseini, Christian Cao, Anabel Selemon, Mairead Whelan, Zahra Premji, Hanane Issa, et al. Protective effectiveness of previous SARS-CoV-2 infection and hybrid immunity against the omicron variant and severe disease: a systematic review and meta-regression. *The Lancet Infectious Diseases*, 2023.
- [19] Wongyeong Choi and Eunha Shim. Assessing the cost-effectiveness of annual COVID-19 booster vaccination in South Korea using a transmission dynamic model. *Frontiers in Public Health*, 11, 2023.
- [20] Ola Andersson, Pol Campos-Mercade, Armando N Meier, and Erik Wengström. Anticipation of COVID-19 vaccines reduces willingness to socially distance. *Journal of Health Economics*, 80:102530, 2021.
- [21] Michael Day. Covid-19: Stronger warnings are needed to curb socialising after vaccination, say doctors and behavioural scientists. *BMJ*, 372, 2021.
- [22] Abdul Aziz Seidu, John Elvis Hagan Jr, Edward Kwabena Ameyaw, Bright Opoku Ahinkorah, and Thomas Schack. The role of testing in the fight against COVID-19: Current happenings in Africa and the way forward. *International Journal of Infectious Diseases*, 98:237–240, 2020.

- [23] Norman MacDonald. *Biological Delay Systems: Linear Stability Theory*. Cambridge University Press, Cambridge, 1989.
- [24] Hal L Smith. *An introduction to delay differential equations with applications to the life sciences*, volume 57. Springer New York, 2011.
- [25] Shasha Gao, Pant Binod, Chidozie Williams Chukwu, Theophilus Kwofie, Salman Safdar, Lora Newman, Seoyun Choe, Bimal Kumar Datta, Wisdom Kwame Attipoe, Wenjing Zhang, et al. A mathematical model to assess the impact of testing and isolation compliance on the transmission of COVID-19. *Infectious Disease Modelling*, 8(2):427–444, 2023.
- [26] Md Abdul Hye, Md Haider Ali Biswas, Mohammed Forhad Uddin, and Md M Rahman. A mathematical model for the transmission of co-infection with COVID-19 and kidney disease. *Scientific Reports*, 14(1):5680, 2024.
- [27] Katelyn M Gostic, Lauren McGough, Edward B Baskerville, Sam Abbott, Keya Joshi, Christine Tedijanto, Rebecca Kahn, Rene Niehus, James A Hay, Pablo M De Salazar, et al. Practical considerations for measuring the effective reproductive number, R_t . *PLoS computational biology*, 16(12):e1008409, 2020.
- [28] Maia Martcheva. *An introduction to mathematical epidemiology*, volume 61. Springer, 2015.
- [29] Pauline Van den Driessche and James Watmough. Reproduction numbers and sub-threshold endemic equilibria for compartmental models of disease transmission. *Mathematical biosciences*, 180(1-2):29–48, 2002.
- [30] Our World in Data. South Korea: Coronavirus pandemic country profile, 2023. <https://ourworldindata.org/coronavirus/country/south-korea> [Accessed: March 20, 2024].
- [31] Fang Wang, Lianying Cao, and Xiaoji Song. Mathematical modeling of mutated COVID-19 transmission with quarantine, isolation and vaccination. *Math Biosci Eng*, 19:8035–8056, 2022.
- [32] Dong Hyun Kim. Community-based COVID-19 seroprevalence survey. *Policy Research Service Project Final Report*, 2023.
- [33] Olumuyiwa James Peter, Hasan S Panigoro, Afeez Abidemi, Mayowa M Ojo, and Festus Abiodun Oguntolu. Mathematical model of COVID-19 pandemic with double dose vaccination. *Acta biotheoretica*, 71(2):9, 2023.
- [34] Pralaya Samal. Curve fitting in Python: A complete guide, 2022. <https://www.askpython.com/python/examples/curve-fitting-in-python> [Accessed: January 17, 2024].
- [35] Youngji Jo, Sourya Shrestha, Munkhzul Radnaabaatar, Hojun Park, and Jaehun Jung. Optimal social distancing policy for COVID-19 control in Korea: a model-based analysis. *Journal of Korean Medical Science*, 37(23), 2022.
- [36] Subhas Kumar Ghosh and Sachchit Ghosh. A mathematical model for COVID-19 considering waning immunity, vaccination and control measures. *Scientific Reports*, 13(1):3610, 2023.
- [37] Jooha Oh, Catherine Apio, and Taesung Park. Mathematical modeling of the impact of omicron variant on the COVID-19 situation in South Korea. *Genomics & Informatics*, 20(2), 2022.

- [38] Institute for health metrics and evaluation: COVID-19 projections, 2023. <https://covid19.healthdata.org/republic-of-korea?view=cumulative-deaths&tab=trend> [Accessed: April 06, 2024].
- [39] Ying Liu and Joacim Rocklöv. The effective reproductive number of the omicron variant of sars-cov-2 is several times relative to delta. *Journal of travel medicine*, 29(3):taac037, 2022.
- [40] Dasom Kim, Sheikh Taslim Ali, Sungchan Kim, Jisoo Jo, Jun-Sik Lim, Sunmi Lee, and Sukhyun Ryu. Estimation of serial interval and reproduction number to quantify the transmissibility of SARS-CoV-2 omicron variant in south korea. *Viruses*, 14(3):533, 2022.
- [41] Eunha Shim, Wongyeong Choi, Donghyok Kwon, Taeyoung Kim, and Youngji Song. Transmission potential of the omicron variant of severe acute respiratory syndrome coronavirus 2 in South Korea, 25 November 2021–8 January 2022. In *Open forum infectious diseases*, volume 9, page ofac248. Oxford University Press, 2022.
- [42] Anis Karuniawati, Ayodhia Pitaloka Pasaribu, Gilbert Lazarus, Vera Irawany, Dwi Utomo Nusantara, Robert Sinto, Maulana Jamil Nasution, Muhammad Riza Lubis, Eka Nurfitri, Mutiara Mutiara, et al. Characteristics and clinical outcomes of patients with pre-delta, delta and omicron sars-cov-2 infection in indonesia (2020–2023): a multicentre prospective cohort study. *The Lancet Regional Health-Southeast Asia*, 22, 2024.
- [43] Olufemi Samuel Amoo, Bosun Tijani, Tochukwu Ifeanyi Onuigbo, Joy Isioma Oraegbu, Dorcas Njeri Kareithi, Josephine Chioma Obi, Esther Temilade Adeniji, Adenike Aderonke Dosunmu, Steven Karera, Temi Filani, et al. Factors affecting COVID-19 testing behaviours among the population in south western Nigeria. *International Journal of Public Health*, 67:1604993, 2022.
- [44] Younjung Kim, Christl A Donnelly, and Pierre Nouvellet. Drivers of SARS-CoV-2 testing behaviour: a modelling study using nationwide testing data in England. *Nature Communications*, 14(1):2148, 2023.
- [45] Dillon Van Rensburg, Alexandra K Adams, Georgina Perez, Sonia Bishop, Teresa Warne, Laurie Hassell, Thomas Quigley, Lorenzo Garza, Virgil Dupuis, Paul K Drain, et al. Factors influencing COVID-19 testing among Native Americans and Latinos in two rural agricultural communities: A qualitative study. *Frontiers in Public Health*, 11, 2023.
- [46] Statista Research Department. Age distribution of COVID-19 death cases South Korea 2023, by age group, 2024. <https://www.statista.com/statistics/1105080/south-korea-coronavirus-deaths-by-age/> [Accessed: May 20, 2024].
- [47] Sileshi Sintayehu Sharbayta, Youngji Jo, Jaehun Jung, and Bruno Buonomo. Data from: The impact of human behavioral adaptation stratified by immune status on covid-19 spread, Forthcoming 2024. Dryad Digital Repository <https://doi.org/10.5061/dryad.wpzgmsbxp>.