

1 **Immunogenicity and safety of DS-5670d, an mRNA-based**
2 **COVID-19 vaccine targeting omicron XBB.1.5: Results from a**
3 **phase 3, randomized, active-controlled study in adults and**
4 **children aged ≥ 12 years**

5

6 Ami Kawamoto¹, Masahiro Hashida¹, Katsuyasu Ishida¹, Kei Furihata², Aisaku Ota², Kaori

7 Takahashi¹, Sachiko Sakakibara¹, Takashi Nakano³, Fumihiko Takeshita¹

8

9 **1** R&D Division, Daiichi Sankyo Co., Ltd., Tokyo, Japan

10 **2** Global DX, Daiichi Sankyo Co., Ltd., Tokyo, Japan

11 **3** Department of Pediatrics, Kawasaki Medical School, Okayama, Japan

12

13 **Corresponding author**

14 Fumihiko Takeshita

15 1-16-13, Kitakasai, Edogawa-ku, Tokyo 134-0081, Japan

16 Tel: +81-3-3680-0151

17 Fax: +81-3-5696-7346

18 E-mail: fumihiko.takeshita@daiichisankyo.com

19

20 **Short title:** DS-5670d omicron XBB.1.5 COVID-19 vaccine immunogenicity and safety

21

22 **Abstract**

23 **Background**

24 Many people worldwide have now acquired immune responses against the severe acute
25 respiratory syndrome-coronavirus-2 (SARS-CoV-2) following previous vaccination and/or
26 infection. As a result, national vaccination programs are now implementing a simplified schedule
27 of single-dose administration and seasonal boosters. In this phase 3 non-inferiority study, we
28 assessed the immunogenicity and safety of a single dose of the lipid nanoparticle-messenger
29 ribonucleic acid vaccine DS-5670d, a monovalent composition for the 2023/24 season,
30 containing an omicron XBB.1.5-derived antigen.

31 **Methods and Findings**

32 Adults and children aged ≥ 12 years were stratified according to their history of both prior SARS-
33 CoV-2 infection plus prior coronavirus disease 2019 (COVID-19) vaccination (subpopulation A),
34 prior infection only (subpopulation B), prior vaccination only (subpopulation C), or no history of
35 either infection or vaccination (subpopulation D), and randomly assigned (1:1) to receive DS-
36 5670d or monovalent BNT162b2 omicron XBB.1.5. In the combined ABC subpopulations (DS-
37 5670d, $n = 362$ vs BNT162b2, $n = 363$), the adjusted geometric mean titer ratio of blood
38 neutralizing activity against SARS-CoV-2 (omicron XBB.1.5) was 1.218 (95% confidence
39 interval [CI], 1.059, 1.401) and the seroresponse rates were 87.3% (DS-5670d) and 82.9%
40 (BNT162b2) with an adjusted difference of 4.5% (95% CI, -0.70 , 9.71). Both results exceeded
41 prespecified non-inferiority margins and the study met the primary endpoint. Immunogenicity
42 data in the overall ABCD population also met non-inferiority criteria. There were no apparent
43 differences in immunogenicity according to age or sex, and analyses suggested that even
44 unvaccinated persons achieved an adequate immune response following a single dose of DS-
45 5670d. There were no major differences in the incidence or severity of adverse events between
46 the study vaccination groups.

47 **Conclusions**

48 A single dose of DS-5670d was immunogenically non-inferior to BNT162b2 and acceptably safe
49 in persons with or without a history of prior infection and/or vaccination.

50 **Trial Registration**

51 Japan Registry of Clinical Trials (jRCT2031230424)

52

53 **Key Words:** COVID-19, DS-5670d, immunogenicity, non-inferiority, Omicron XBB.1.5,
54 SARS-CoV-2

55

56 **Abbreviations:** AE, adverse event; COVID-19, coronavirus disease 2019; CI, confidence
57 interval; GMT, geometric mean titer; LNP, lipid nanoparticle; mRNA, messenger ribonucleic
58 acid; PPS, per protocol set; SAE, serious adverse event; SARS-CoV-2, severe acute respiratory
59 syndrome-coronavirus-2; SD, standard deviation.

60

61 **Author summary**

62 **Why was this study done?**

- 63
- 64 • The global emergency response against the coronavirus disease 2019 (COVID-19)
65 pandemic is now being superseded by annual immunization using an updated vaccine
66 composition to reduce the disease burden associated with newly emerging variants.
 - 67 • We conducted a comparative study of two newly authorized updated vaccine
68 compositions containing the antigen derived from omicron XBB.1.5, which was
69 recommended for the 2023/24 season.
 - 70 • We intended to assess the immunogenicity and safety of a single dose of DS-5670d
compared with BNT162b2 in Japanese adults and children aged ≥ 12 years.

71 **What did the researchers do and find?**

- 72 • In persons who had received prior vaccination, or who had previously had COVID-19, or
73 both, DS-5670d was non-inferior to BNT162b2 in terms of blood neutralizing activity and
74 seroresponse rates, and immune responses were not influenced by age or sex.
- 75 • Among unvaccinated persons, those who had been exposed to SARS-CoV-2 by prior
76 infection achieved an adequate immune response following a single dose of DS-5670d;
77 however, the group who had had no previous exposure at all was too small to properly
78 evaluate.
- 79 • There were no major differences in the frequency or severity of adverse events between
80 the study vaccination groups, and there were no DS-5670d-related serious adverse
81 events.

82 **What do these findings mean?**

- 83 • DS-5670d was immunogenically non-inferior to BNT162b2, which has already been
84 widely administered in Japan.
- 85 • There were no new critical safety concerns associated with DS-5670d, suggesting that it
86 could be a useful SARS-CoV-2 vaccine option.
- 87 • Taken together, the results from this study of DS-5670d and those from previous studies
88 evaluating other compositions of DS-5670, i.e., those containing antigens from different
89 strains of SARS-CoV-2, provide corroborating evidence that the DS-5670 vaccine
90 platform can be applied to produce effective and safe seasonal vaccines against future
91 emerging strains.

92

93 **Introduction**

94 Although coronavirus disease 2019 (COVID-19) no longer constitutes a global emergency, it
95 remains an ongoing threat to public health [1]. The emergence of novel escape variants of
96 severe acute respiratory syndrome-coronavirus-2 (SARS-CoV-2), plus waning protective
97 immunity over time, has led to a continuous need for the development, testing and authorization
98 of updated vaccine compositions [2, 3]. The initial roll-out of primary vaccination with
99 monovalent messenger ribonucleic acid (mRNA)-based vaccines such as BNT162b2
100 (Comirnaty, Pfizer-BioNTech) and mRNA-1273 (Spikevax, Moderna) targeting the original
101 Wuhan strain of SARS-CoV-2 [4] was initially followed by boosters with the same monovalent
102 composition, and then by bivalent boosters targeting both the original strain and omicron BA.4-5
103 [5, 6]. Immunization programs against COVID-19 have now moved away from emergency use
104 towards seasonal vaccination, to boost protective immune responses against emerging variants
105 of SARS-CoV-2 [1, 7]. In addition, a single-dose regimen is now recommended for most
106 recipients, as either a primary or booster vaccination [8, 9]. For the 2023/24 season, monovalent
107 vaccine compositions containing an antigen from the omicron XBB.1.5 strain were authorized
108 [10], while for 2024/25, vaccines containing an antigen from the JN.1 lineage have been
109 recommended [11, 12].

110 DS-5670 is a vaccine platform formulation based on mRNA encapsulated in lipid
111 nanoparticles (LNP-mRNA) [13], which can be applied to compositions containing antigens
112 derived from different strains of SARS-CoV-2. To date, several different compositions of DS-
113 5670, either monovalent or bivalent, have been clinically evaluated. DS-5670a, a monovalent
114 vaccine containing an antigen from the original strain, demonstrated a clinically acceptable
115 safety profile and favorable immune responses in adults [14], and was authorized in Japan for
116 use as a booster vaccination. DS-5670a/b, a bivalent vaccine containing antigens from both the
117 original strain and from omicron BA.4-5, was shown to be well-tolerated, induced broad

118 neutralization activity across omicron sub-lineages, and was immunogenetically non-inferior to
119 the bivalent composition of BNT162b2 containing corresponding original and omicron BA.4-5
120 antigens when administered as a booster vaccination in adults (Daiichi Sankyo Co., Ltd.; data
121 on file). DS-5670a/b also had a manageable safety profile and showed non-inferior
122 immunogenicity to bivalent BNT162b2 when administered as a booster to children aged 5–11
123 years [15].

124 In November 2023, a monovalent DS-5670 vaccine containing an antigen derived from
125 omicron XBB.1.5 (DS-5670d; Daichirona®, Daiichi Sankyo Co., Ltd.) was approved by the
126 Japanese Ministry for Health, Labour and Welfare as a booster COVID-19 vaccination [16], and
127 it was launched in December as part of the Japanese immunization program for the 2023/24
128 season. Herein, we report data from a phase 3 non-inferiority study conducted in adults and
129 children aged ≥ 12 years which aimed to evaluate the safety and immunogenicity of a single
130 dose of DS-5670d in those with or without history of prior infection and/or vaccination.

131

132 **Methods**

133 **Participants**

134 This study included adults and children aged ≥ 12 years enrolled from 15 sites across Japan (**S1**
135 **Table**). Written informed consent was obtained from each participant or their legal
136 representative prior to initiation of study procedures. Eligible participants were stratified into 4
137 subpopulations: (A) those with a history of both SARS-CoV-2 infection and COVID-19
138 vaccination, (B) those with a history of SARS-CoV-2 infection but without a history of COVID-19
139 vaccination, (C) those without a history of SARS-CoV-2 infection but with a history of COVID-19
140 vaccination, or (D) those without any history of SARS-CoV-2 infection or COVID-19 vaccination
141 prior to the date of informed consent. Prior infection was defined as a positive test result for

142 SARS-CoV-2 (either a reverse transcription-polymerase chain reaction test, other nucleic acid
143 detection test, or SARS-CoV-2 antigen test), or a diagnosis of COVID-19.

144 Key exclusion criteria were the presence of serious cardiovascular, renal, hepatic, blood,
145 neuropsychiatric or developmental disorder, thrombocytopenia, or coagulopathy; history of
146 vaccine-related seizures or epilepsy, or history of anaphylaxis or severe allergy due to
147 administration of food, drugs, cosmetics or vaccines; current or prior history of myocarditis or
148 pericarditis; or a previous diagnosis of immunodeficiency or a close relative with congenital
149 immunodeficiency. Persons who had tested positive for SARS-CoV-2 infection or were
150 diagnosed with COVID-19 within 3 months before the date of informed consent, or had
151 symptoms suggestive of SARS-CoV-2 infection at the time of informed consent, or who had a
152 positive SARS-COV-2 test at the time of eligibility evaluation were also ineligible for
153 participation.

154

155 **Study design, treatments, and blinding**

156 This was a phase 3 randomized, active-comparator, observer-blind, non-inferiority study
157 registered with the Japan Registry of Clinical Trials with the identifier jRCT2031230424. The
158 study was conducted in accordance with the Declaration of Helsinki, Good Clinical Practice
159 guidelines, and all national and regional ordinance, and was approved by the relevant ethical
160 committees at each study site.

161 The study design is shown in **Fig. 1A**. Participants were divided into subpopulations A–D
162 according to their prior infection/vaccination status. The members of each subpopulation were
163 then randomly assigned in a 1:1 ratio to receive either DS-5670d (60 µg of mRNA) or
164 monovalent BNT162b2 (containing an antigen from omicron XBB.1.5, 30 µg of mRNA). The
165 comparator BNT162b2 vaccine was supplied by the Japanese government to be used as the

166 study control. Random assignment was the responsibility of an independent statistician, and
167 vaccines were dispensed and administered intramuscularly into the deltoid region of the upper
168 arm by unblinded site personnel on day 1. Investigators were blinded to treatment, and
169 uploaded participant data via an interactive web response system. Participants and their legal
170 representatives, the study monitor and members of the study advisory board, sponsor and
171 collaborators, and personnel performing antibody titer determination were also blinded to
172 vaccine assignment.

173

174 **Fig. 1. (A) Study design and (B) CONSORT flow diagram of participant disposition**
175 **through the study.**

176 **A**

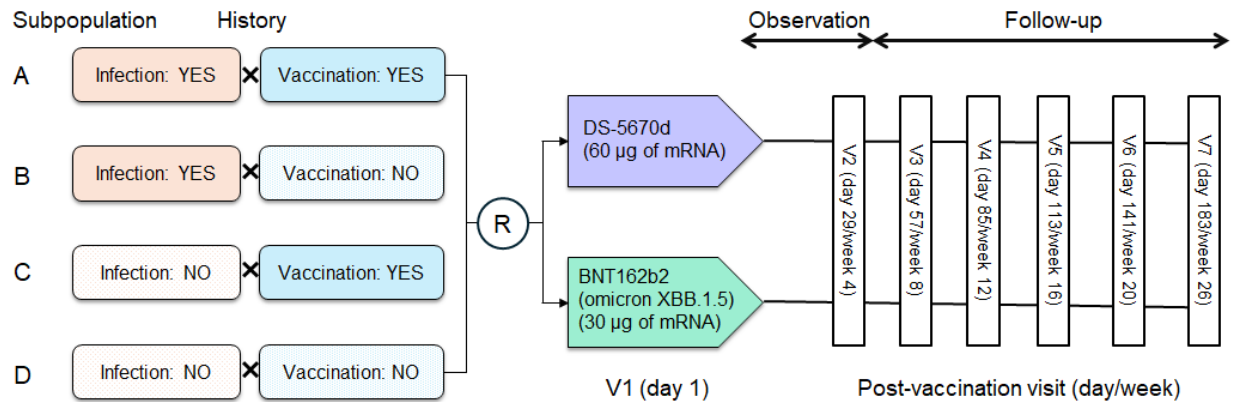

177

178

179 **B**

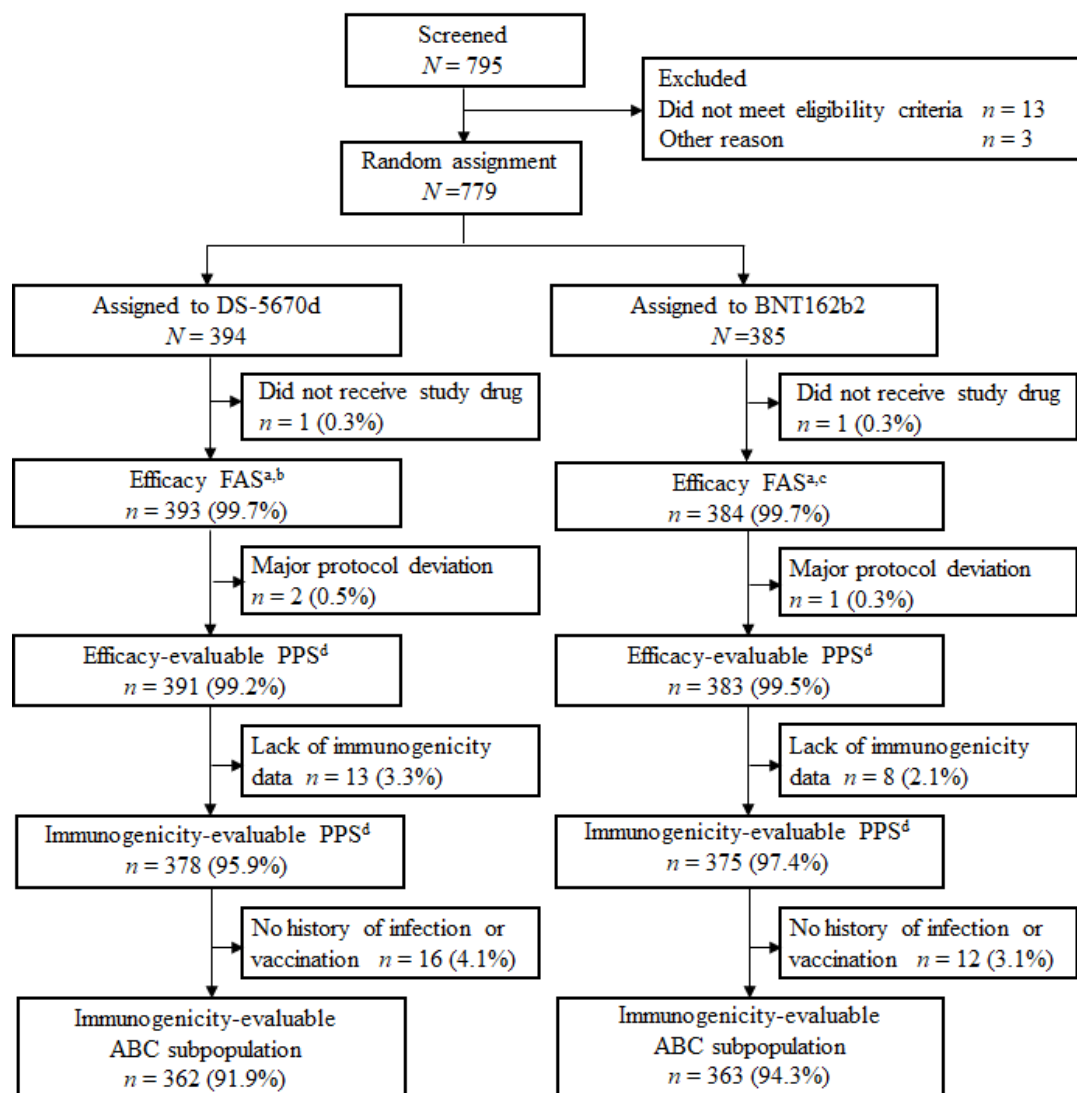

180

^aThe efficacy FAS and safety analysis sets were identical. ^bIncluded 147 (37.4%) in subpopulation A; 67 (17.0%) in subpopulation B; 163 (41.5%) in subpopulation C, and 16 (4.1%) in subpopulation D.

^cIncluded 139 (36.2%) in subpopulation A; 66 (17.2%) in subpopulation B; 167 (43.5%) in subpopulation C, and 12 (3.1%) in subpopulation D. ^dCombined ABCD subpopulation. FAS, full analysis set; PPS, per protocol set; R, random assignment.

181

182 The first participant was enrolled on 9 January 2024, the initial observation period lasted
183 for 4 weeks post-vaccination, and the follow-up period was planned to continue up to 26 weeks
184 post-vaccination. In the current manuscript, we report the results up to 4 weeks post-
185 vaccination.

186

187 **Assessments and outcomes**

188 The study objective was to verify the non-inferiority of DS-5670d to BNT162b2 in terms of
189 immunogenicity, and to evaluate safety.

190 A sequential procedure was followed for the immunogenicity analyses. First, non-
191 inferiority was tested for the combined ABC subpopulations; only if non-inferiority was confirmed
192 was testing continued for the combined ABCD subpopulation. The primary efficacy endpoint
193 was geometric mean titer (GMT) of blood neutralizing activity against SARS-CoV-2 (omicron
194 variant XBB.1.5) and seroresponse rate at day 29 (4 weeks) after study vaccine administration
195 in participants with any history of SARS-CoV-2 infection and/or vaccination (the combined ABC
196 subpopulation). The key secondary efficacy endpoint was blood neutralizing activity GMT and
197 seroresponse rate at day 29 after study vaccination in all study participants regardless of
198 infection or vaccination history (the combined ABCD subpopulation). The incidence of COVID-
199 19 (confirmed by the investigator based on a positive SARS-CoV-2 infection test plus any
200 COVID-19 symptoms) up to day 29 after study vaccination was also evaluated.

201 Safety endpoints included the occurrence of solicited adverse events (AEs), unsolicited
202 AEs, serious AEs (SAEs), and clinically relevant changes in laboratory values. AEs were coded
203 using the Medical Dictionary for Regulatory Activities version 26.1. Health status was recorded
204 in an electronic diary by participants or their representative. Solicited AEs (injection site events

205 [redness, swelling, induration, pain, warmth, and pruritus] and systemic events [fever, malaise,
206 headache, rash, and myalgia]) were collected up to day 8 post-administration, and unsolicited
207 AEs and SAEs up to day 29. Laboratory tests were performed pre-vaccination and at day 29
208 post-vaccination.

209

210 **Statistical analysis**

211 To confirm non-inferiority of DS-5670d versus BNT162b2 at day 29, the lower limit of the two-
212 sided 95% confidence interval (CI) of the GMT ratio was required to be above the non-inferiority
213 margin of 0.67, and the lower limit of the two-sided 95% CI for the difference in the
214 seroresponse rate was required to exceed -10% in favor of DS-5670d. Based on this, plus
215 taking into account anticipated dropout rates, the number of participants in the combined ABC
216 subpopulations required to power the immunogenicity non-inferiority comparison was 690 (of
217 whom 345 would receive DS-5670d and 345 would receive BNT162b2). Among these, 100
218 participants (50 per vaccine group) were required to be vaccine-naïve (i.e., included in
219 subpopulation B). No sample size requirement or limitation was set for subpopulation D as the
220 number of eligible participants for this group (no prior infection, no prior vaccination) was
221 considered likely to be small.

222 Immunogenicity analyses were conducted based on the treatment group to which each
223 participant was assigned; the primary analysis population was the immunogenicity-evaluable
224 per protocol set (PPS), which included participants who received a dose of study drug, had a
225 pre-administration and at least one post-administration immunogenicity measurement, and had
226 no protocol violations that could affect the immunogenicity evaluations. Safety analyses were
227 conducted based on the study drug that was actually administered. Unsolicited AEs were
228 evaluated using the safety analysis set, which included all participants who received at least one
229 dose of study drug; solicited AEs were evaluated in the solicited safety analysis set, which

230 included all participants in the safety analysis set for whom information on the occurrence of at
231 least one solicited AE was available.

232 Baseline participant characteristics were recorded descriptively as number (%), mean
233 (standard deviation [SD]), or median (range). For the calculation of adjusted GMT (and two-
234 sided 95% CI), a linear model was applied with common log transformed neutralizing titers as
235 the dependent variable, the study vaccine group as the independent variable, and the common
236 log transformed baseline titer and the categories of subpopulation as covariates. For the
237 adjusted seroresponse rate, the between-group difference (and two-sided 95% CI) was
238 calculated. The Mantel-Haenszel method was applied, and subpopulation was included as a
239 stratum. The COVID-19 incidence rate was calculated using the PPS as the number of cases
240 per 1000 person-years. Solicited AEs were recorded in an electronic diary by each participant or
241 their legal representative; the presence or absence of solicited AEs and their severity were
242 recorded up to 8 days post-vaccine administration, and any other (unsolicited) AEs were
243 recorded up to day 29. The number (%) of participants with events were calculated according to
244 the respective analysis set and tabulated. All statistical calculations were performed using SAS
245 software version 9.4 or later (SAS Institute, Inc., Cary, NC, USA).

246

247 **Results**

248 **Population**

249 A total of 779 participants were enrolled into the study, of whom 394 were assigned to receive
250 DS-5670d and 385 to receive BNT162b2 omicron XBB.1.5. The disposition and analysis
251 populations are presented in **Fig. 1B**. One participant in each group did not receive study
252 vaccination, so the safety analysis set included 393 participants in the DS-5670d group and 384

253 in the BNT162b2 group. Overall, the safety analysis set included 286 participants in
254 subpopulation A, 133 in subpopulation B, 330 in subpopulation C, and 28 in subpopulation D.

255 After exclusions due to major protocol deviations and lack of immunogenicity data, the
256 immunogenicity-evaluable PPS (combined subpopulations ABCD) included 378 participants in
257 the DS-5670d group and 375 in the BNT162b2 group. For the primary efficacy endpoint, the 28
258 participants in subpopulation D were excluded; thus, the immunogenicity-evaluable ABC
259 subpopulation comprised 362 in the DS-5670d group and 363 in the BNT162b2 group.

260 The demographics and baseline characteristics of participants are described in **Table 1**.

261 The median age of participants was 46.0 years (range 12–90 years), with the majority aged
262 between 18–65 years (644/777, 82.9%). Slightly more than half of participants were male
263 (425/777, 54.7%), and had a history of SARS-CoV-2 infection (419/777, 53.9%). Many
264 participants had received prior vaccination (616/777, 79.3%), with monovalent (original strain)
265 vaccines in 313 (40.3%) of participants and bivalent (original strain/omicronBA.4-5) vaccines in
266 275 (35.4%). Characteristics were generally similar across the study vaccine groups, and there
267 were no notable differences between the safety analysis set and the immunogenicity-evaluable
268 PPS.

269

270 **Table 1. Baseline demographics and clinical characteristics (safety analysis set).**

	DS-5670d (n = 393)	BNT162b2 (n = 384)	All participants (N = 777)
Age (years)			
Median (range)	47.0 (12, 90)	45.5 (12, 77)	46.0 (12, 90)
12–17	35 (8.9)	29 (7.6)	64 (8.2)
18–65	320 (81.4)	324 (84.4)	644 (82.9)

≥65	38 (9.7)	31 (8.1)	69 (8.9)
Male sex	214 (54.5)	211 (54.9)	425 (54.7)
Weight (kg), median (range)	62.2 (31, 127)	62.4 (35, 132)	62.4 (31, 132)
Height (cm), median (range)	165.2 (140, 185)	164.1 (147, 190)	164.6 (140, 190)
History of SARS-CoV-2 infection	214 (54.5)	205 (53.4)	419 (53.9)
Self-reported prior infection	181 (46.1)	171 (44.5)	352 (45.3)
Positive antibody test ^a	91 (23.2)	67 (17.4)	158 (20.3)
History of COVID-19 vaccination	310 (78.9)	306 (79.7)	616 (79.3)
Original strain	158 (40.2)	155 (40.4)	313 (40.3)
Original/omicron bivalent	141 (35.9)	134 (34.9)	275 (35.4)
Omicron strain XBB.1.5	11 (2.8)	17 (4.4)	28 (3.6)
Interval from last vaccination (months)			
Median (range)	15.7 (3, 34)	15.4 (3, 30)	15.6 (3, 34)
3–11	48 (12.2)	48 (12.5)	96 (12.4)
≥12	262 (66.7)	257 (66.9)	519 (66.8)
Subpopulation			
A	147 (37.4)	139 (36.2)	286 (36.8)
B	67 (17.0)	66 (17.2)	133 (17.1)
C	163 (41.5)	167 (43.5)	330 (42.5)
D	16 (4.1)	12 (3.1)	28 (3.6)

Both DS-5670d and BNT162b2 were monovalent vaccines against omicron XBB.1.5. Data are reported as *n* (%) unless otherwise stated. All participants (100%) were of Asian race. ^aN-antibody positivity was centrally confirmed by an immunochromatographic test kit (Rapidfields S+N IgG [RF-NC003]; Kurabo Industries Ltd., Osaka, Japan) on day 1 prior to study vaccination. COVID-19, coronavirus disease 2019; SARS-CoV-2, severe acute respiratory syndrome-coronavirus-2.

271

272 **Immunogenicity/efficacy**

273 In the primary analysis (combined ABC subpopulations), the adjusted GMT ratio of DS-5670d to
 274 BNT162b2 was 1.218 (95% CI, 1.059, 1.401). Seroresponse rates were 87.3% in the DS-5670d
 275 group and 82.9% in the BNT162b2 group; the adjusted difference was 4.5% (95% CI, -0.70,
 276 9.71). Both of these results exceeded the prespecified non-inferiority margins (**Table 2**), and the
 277 study met the primary endpoint.

278

279 **Table 2. Comparison of neutralizing activities against SARS-CoV-2 (omicron XBB.1.5.6) at**
 280 **day 29.**

	DS-5670d	BNT162b2
Primary analysis (immunogenicity-evaluable ABC subpopulation)	N = 362	N = 363
Adjusted GMT (95% CI) ^a	1691.877 (1527.122, 1874.405)	1388.927 (1253.021, 1539.573)
Adjusted GMT ratio (95% CI) ^a	1.218 (1.059, 1.401)	
Non-inferiority criterion: Met ^b		
Seroresponse rate (95% CI) ^c	87.3 (83.42, 90.54)	82.9 (78.65, 86.65)
Adjusted difference (95% CI) ^d	4.5 (-0.70, 9.71)	

Non-inferiority criterion: Met ^e		
Secondary analysis (immunogenicity-evaluable ABCD population)	N = 378	N = 375
Adjusted GMT (95% CI) ^a	1326.489 (1162.071, 1514.170)	119.097 (976.369, 1282.689)
Adjusted GMT ratio (95% CI) ^a	1.185 (1.025, 1.371)	
Non-inferiority criterion: Met ^b		
Seroresponse rate (95% CI) ^c	86.8 (82.94, 90.02)	83.2 (79.02, 86.84)
Adjusted difference (95% CI) ^d	3.7 (-1.39, 8.87)	
Non-inferiority criterion: Met ^e		

^aThe adjusted GMT/GMT ratio (DS-5670d vs. BNT162b2 omicron XBB.1.5) and 95% CI were calculated based on an analysis of covariance model with the change of the common log transformed titers as the explained variable, the study drug administration group as the exploratory variable, the common log transformed baseline titers, and the categories of sub-population as the covariates. ^bNon-inferiority criterion for GMT ratio: the lower limit of the 95% CI was required to exceed 0.67. ^cThe 95% CI was calculated based on the Clopper Pearson exact method. ^dThe seroresponse rate adjusted

difference (DS-5670d – BNT162b2 omicron XBB.1.5) was calculated using the Mantel-Haenszel method and the 95% CI was calculated based on the stratified Newcombe-Wilson score method (where the strata were the categories of sub-population, i.e., A, B, C, D). ^eNon-inferiority criterion for difference in seroresponse: the lower limit of the 95% CI of was required to exceed –10%. CI, confidence interval; GMT, geometric mean titer; SARS-CoV-2, severe acute respiratory syndrome-coronavirus-2.

281

282 In the secondary analysis (combined ABCD subpopulations), the adjusted GMT ratio
283 was 1.185 (95% CI, 1.025, 1.371), and the adjusted difference in seroresponse rate was 3.7%
284 (95% CI, –1.39, 8.87). Again, both results exceeded the prespecified non-inferiority margins
285 (**Table 2**).

286 An analysis of blood neutralizing activity and seroresponse according to key subgroups
287 (age group, sex, and subpopulation) is shown in **Fig. 2**. The GMT ratio tended to favor DS-
288 5670d in all patients with a history of vaccination, and also in those with infection history but
289 without a history of vaccination.

290

291 **Fig. 2. Forest plot of immunogenicity against SARS-CoV-2 (omicron XBB.1.5.6) at day 29**
292 **by subgroup for (A) observed GMT ratio of blood neutralizing activity^a and (B)**
293 **seroresponse rate^b (immunogenicity-evaluable PPS).**

294 **A**

295

It is made available under a [CC-BY 4.0 International license](https://creativecommons.org/licenses/by/4.0/).

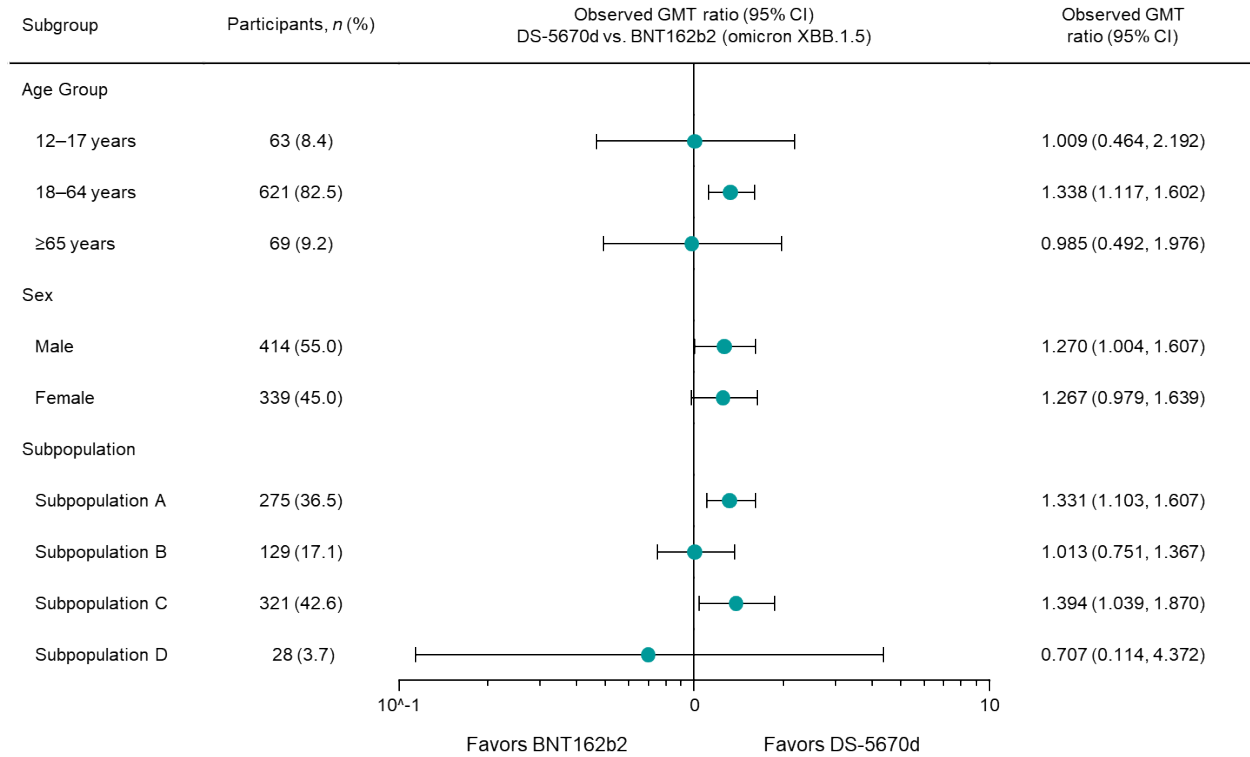

296

297 **B**

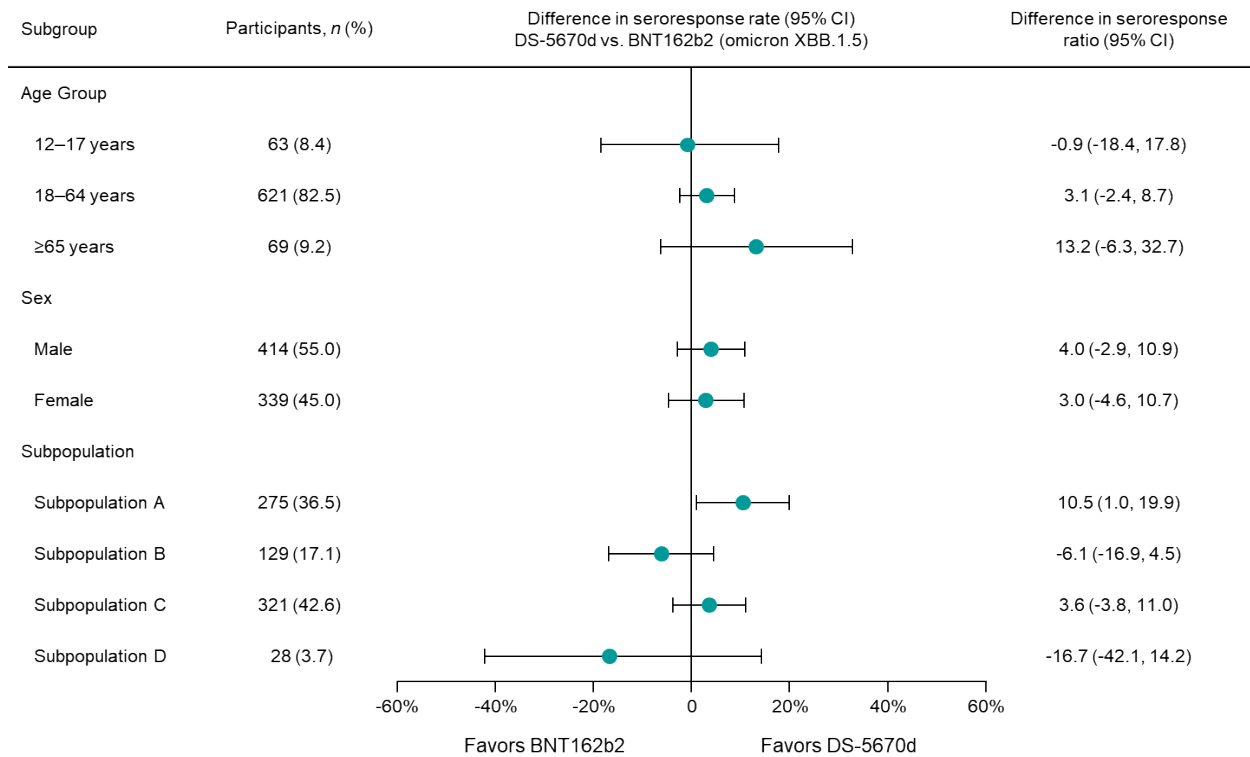

298

^aThe observed GMT ratio (DS-5670d vs. BNT162b2 omicron XBB.1.5) and 95% CI were calculated based on the Student's distribution of the mean difference in the log-transformed values then back transformed to the original scale for presentation. ^bThe seroresponse rate observed difference (DS-5670d – BNT162b2 omicron XBB.1.5) and 95% CI were calculated based on the Newcombe-Wilson score method. CI, confidence interval; PPS, per protocol set; SARS-CoV-2, severe acute respiratory syndrome-coronavirus-2.

299

300

301 The incidence rate of COVID-19 to day 29 after study vaccination is presented in **Fig. 3**.

302 Both study vaccines appeared to be effective in preventing the onset of COVID-19 during this

303 period, with two events reported in the DS-5670d group and three in the BNT162b2 group.

304

305 **Fig. 3. Incidence of investigator-confirmed COVID-19 (efficacy-evaluable PPS).**

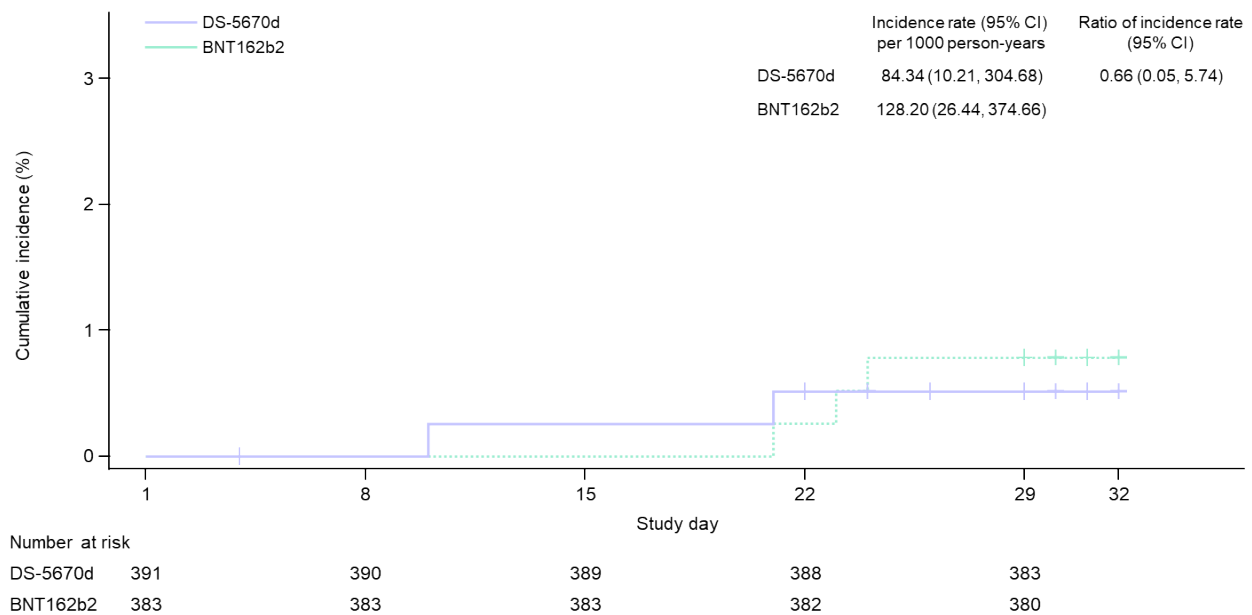

306

CI, confidence interval; PPS, per protocol set.

307

308

309 **Safety**

310 AEs occurring during the study are summarized in **Table 3**. The majority of participants
311 experienced at least one AE, with most AEs judged by the investigator to be vaccine-related.
312 There were very few serious AEs across the study vaccine groups; none of the serious AEs
313 were judged to be study vaccine-related.

314

315 **Table 3. Summary of AEs (safety analysis set).**

	DS-5670d (N = 393)	BNT162b2 (N = 384)
Participants with ≥1 solicited AE	365 (92.9)	348 (90.6)
Participants with ≥1 severe solicited AE	20 (5.1)	20 (5.2)
Participants with ≥1 solicited injection site AE	361 (91.9)	339 (88.3)
Participants with ≥1 severe solicited injection site AE	14 (3.6)	12 (3.1)
Participants with ≥1 solicited systemic AE	183 (46.6)	180 (46.9)
Participants with ≥1 severe solicited systemic AE	7 (1.8)	10 (2.6)
Participants with ≥1 unsolicited TEAE	77 (19.6)	74 (19.3)
Participants with ≥1 study vaccine-related unsolicited TEAE	32 (8.1)	14 (3.6)
Participants with ≥1 severe unsolicited TEAE	0	0
Participants with ≥1 serious TEAE	0	2 (0.5)
Participants with ≥1 study vaccine-related serious TEAE	0	0
Participants with TEAE leading to discontinuation	0	0

Participants with fatal TEAE	0	0
------------------------------	---	---

Data are shown as *n* (%). Solicited AEs were collected from the start of the study drug until day 8 after study vaccination. AE, adverse event; TEAE, treatment-emergent adverse event.

316

317

318

319

320

321

322

323

324

325

The majority of solicited AEs were mild or moderate in intensity (**Fig. 4**). The most frequently reported solicited injection site AE across both study vaccine groups was mild pain. Unsolicited treatment-emergent AEs (all causality and study vaccine-related) are described in **S2 Table**. Overall, there were no major differences in the incidence or severity of solicited or unsolicited AEs between the study vaccine groups.

Fig. 4. Solicited AEs (A) injection site AEs; (B) systemic AEs (safety analysis set).

A

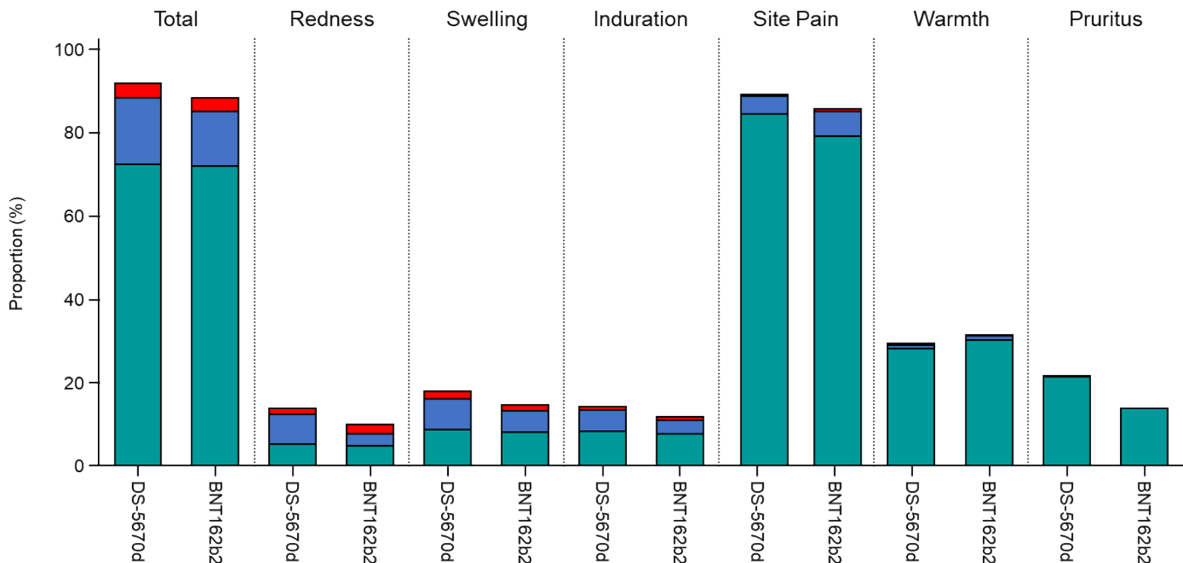

326

Total (%)		91.9%	88.3%	14.0%	9.9%	17.8%	14.6%	14.2%	12.0%	89.3%	85.7%	29.3%	31.5%	21.6%	13.8%
Severe	■	3.6%	3.1%	1.5%	2.1%	1.8%	1.3%	0.8%	1.0%	0.5%	0.5%	0.3%	0.3%	0%	0%
Moderate	■	16.0%	13.3%	7.1%	2.9%	7.4%	5.2%	5.1%	3.1%	4.3%	6.0%	0.8%	1.0%	0.3%	0%
Mild	■	72.3%	71.9%	5.3%	4.9%	8.7%	8.1%	8.4%	7.8%	84.5%	79.2%	28.2%	30.2%	21.4%	13.8%

327

328 **B**

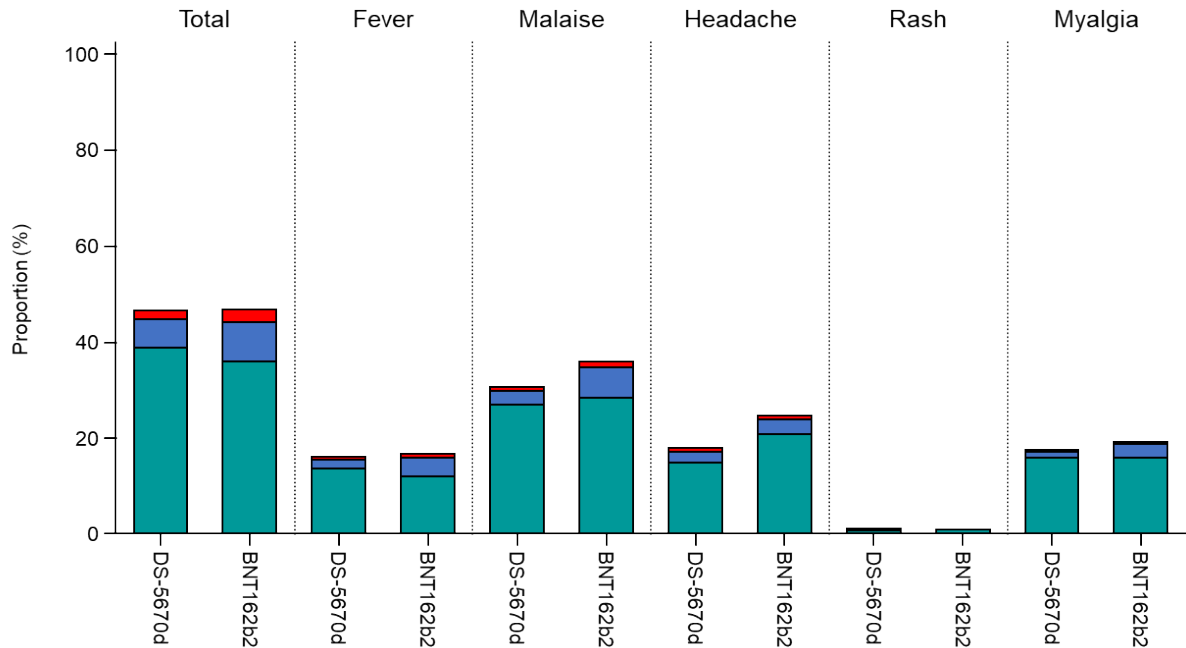

Total (%)		46.6%	46.9%	16.0%	16.7%	30.5%	35.9%	17.8%	24.7%	1.0%	1.0%	17.3%	19.0%
Severe	■	1.8%	2.6%	0.5%	0.8%	0.8%	1.3%	0.8%	0.8%	0%	0%	0.3%	0.3%
Moderate	■	5.9%	8.3%	1.8%	3.9%	2.8%	6.3%	2.3%	3.1%	0.3%	0%	1.3%	2.9%
Mild	■	38.9%	35.9%	13.7%	12.0%	27.0%	28.4%	14.8%	20.8%	0.8%	1.0%	15.8%	15.9%

329

AE, adverse event.

330

331

332 Discussion

333 In this study, non-inferior immunogenicity of a single dose of monovalent DS-5670d to
 334 BNT162b2 omicron XBB.1.5 was confirmed in participants aged ≥ 12 years, regardless of
 335 infection or vaccination history. Both the primary and secondary efficacy endpoints were met,
 336 with the non-inferiority criteria being met in both the combined ABC population (with any history
 337 of prior infection and/or vaccination), and in the overall PPS including participants without any

338 history of prior infection or vaccination. In the combined ABC subpopulation, the adjusted GMT
339 ratio (DS-5670d vs. BNT162b2) was 1.218 (95% CI, 1.059, 1.401), and the difference in the
340 seroresponse rate was 4.5 (95% CI, -0.70, 9.71), both of which exceeded the non-inferiority
341 margin.

342 In the analyses of immunogenicity by key demographic subgroups, there were no
343 apparent differences in GMTs or seroresponse rates according to age group or sex. In addition
344 to providing protective efficacy against severe COVID-19, infection-related death, and long
345 COVID in high risk populations such as older adults [17, 18], recent evidence clearly indicates
346 the benefits of COVID-19 vaccination for children and younger adults in terms of both their
347 mental and physical health [19]. In a country such as Japan, where adults aged ≥ 65 comprise
348 almost 30% of the population [20], continued vaccine coverage and infection prevention and
349 control measure remain essential to protect at-risk and frail individuals, and sustain medical and
350 social systems [21]. It is also important to achieve good immunogenicity in males, who typically
351 have lower antibody responses to vaccination compared with females [22, 23], and which may
352 impact the attainment of effective population immunity.

353 In the analyses of immunogenicity by subpopulation, the data suggested that even
354 participants without any history of vaccination (subpopulation B) could achieve an adequate
355 immune response with a single dose of DS-5670d. Such data emphasize the universality of DS-
356 5670d immunogenicity regardless of prior vaccination history. In terms of participants without
357 any history of infection or vaccination (subpopulation D), DS-5670d appears to be somewhat
358 less immunogenic at first glance, but it is difficult to draw definitive conclusions due to the small
359 number of participants available for evaluation. Overall, however, the participants enrolled in this
360 study are a reasonably accurate reflection of the current real-world situation, where most people
361 have now had a vaccination, or been infected, or both (i.e., comparable to the combined ABC
362 population), and the number of those who have never been infected or vaccinated is dwindling.

363 As such, the confirmation of non-inferiority of DS-5670d among both the ABC population and
364 the ABCD population suggests that future seasonal DS-5670 vaccines will make a significant
365 contribution to real-world public health in Japan.

366 The incidence of COVID-19 up to day 29 after study vaccination was low in both groups.
367 However, the duration of observation was too short, and continued follow-up would be
368 necessary before any inferences regarding the protective effects of DS-5670d can be made.

369 In terms of safety, there were no marked differences between the vaccine groups in the
370 incidence or severity of solicited or unsolicited AEs. In line with results of previous studies
371 evaluating different DS-5670 compositions, the most common solicited injection site AE was
372 injection site pain, with most events being mild or moderate in severity [14, 15]. The most
373 common solicited systemic AE in this study was malaise. This differed from the previously
374 published data for DS-5670a in adults, where myalgia was the most common solicited systemic
375 AE [14]. However, malaise was also the most common solicited systemic AE in studies of DS-
376 5670a/b in both adults (Daiichi Sankyo Co., Ltd., data on file) and children [15]. Both injection
377 site pain and malaise (or fatigue) are among the most frequently reported AEs among persons
378 receiving mRNA vaccines against COVID-19, and are not unique to DS-5670 vaccines [24, 25].
379 There were no serious treatment-emergent unsolicited AEs which were judged to be related to
380 study vaccine.

381 The main study limitation is the short duration of follow-up, which limits any conclusions
382 relating to the long-term safety of DS-5670d, or the ongoing protection it may offer against
383 COVID-19. In addition, the inclusion of only Asian patients may prevent generalization of the
384 results to other locations and races.

385 In summary, the results of this phase 3 randomized, active-comparator, observer-blind
386 study demonstrated the immunogenic non-inferiority of a single dose of DS-5670d regardless of
387 history of prior infection or vaccination status and confirmed the clinically acceptable safety

388 profile. Together with the data from previous DS-5670 clinical studies, these results contribute to
389 the growing evidence that this LNP-mRNA vaccine platform technology can be harnessed to
390 provide a significant contribution to public health via the production of COVID-19 vaccines in
391 future seasons.

392

393 **Supporting Information**

394 **S1 CONSORT Checklist.** Consolidated Standards of Reporting Trials (CONSORT) Checklist.

395 (PDF)

396 **S1 Text. Study protocol.** (PDF)

397 **S1 Table. Listing of study sites and investigators.** (PDF)

398 **S2 Table. Unsolicited AEs occurring in >1 participant in either group (safety analysis set).**

399 (PDF)

400

401 **Acknowledgments**

402 The authors extend their thanks to all the participants and legal representatives who took part in
403 the studies, and to the investigators and staff at the study sites for their support in conducting
404 the study. The authors also thank all members of the clinical study team for valuable advice and
405 support in the performance of this study. Finally, the authors thank Sally-Anne Mitchell, PhD, of
406 McCann Health CMC, for providing medical writing support, which was funded by Daiichi
407 Sankyo Co., Ltd.

408

409 **Funding:** This study was conducted by Daiichi Sankyo Co., Ltd. (Tokyo, Japan). The work to
410 develop and produce a vaccine against SARS-CoV-2 was funded and supported by the Ministry
411 of Health, Labour and Welfare (MHLW) and Japan Agency for Medical Research and
412 Development (AMED) under Grant Number JP21nf0101625, as part of the initiatives to combat
413 COVID-19.

414

415 **Data Availability Statement:** The data underlying this report will be made available upon
416 reasonable request.

417

418 **Competing Interests:** AK, MH, KI, KF, AO, KT, SS, and FT are employees of Daiichi Sankyo
419 Co., Ltd.; AO, KT, and SS hold stock in Daiichi Sankyo Co., Ltd. TN reports receiving
420 remuneration from Daiichi Sankyo Co., KM Biologics Co., Ltd., Meiji Seika Pharma Co., Ltd.,
421 Mitsubishi Tanabe Pharma Corporation, Moderna, Inc., and Sanofi K.K.

422

423 **References**

- 424 1. Ulrichs T, Rolland M, Wu J, Nunes MC, El Guerche-Seblain C, Chit A. Changing
425 epidemiology of COVID-19: Potential future impact on vaccines and vaccination
426 strategies. *Expert Rev Vaccines*. 2024;23(1):510-22. doi:
427 10.1080/14760584.2024.2346589. PMID: 38656834.
- 428 2. Titball RW, Bernstein DI, Fanget NVJ, Hall RA, Longet S, MacAry PA, et al. Progress with
429 COVID vaccine development and implementation. *NPJ Vaccines*. 2024;9(1):69. doi:
430 10.1038/s41541-024-00867-3. PMID: 38561358; PMCID: PMC10985065.
- 431 3. Dadras O, SeyedAlinaghi S, Karimi A, Shojaei A, Amiri A, Mahdiabadi S, et al. COVID-19
432 vaccines' protection over time and the need for booster doses; A systematic review. *Arch*
433 *Acad Emerg Med*. 2022;10(1):e53. doi: 10.22037/aaem.v10i1.1582. PMID: 36033989;
434 PMCID: PMC9397599.
- 435 4. Teo SP. Review of COVID-19 mRNA vaccines: BNT162b2 and mRNA-1273. *Journal of*
436 *Pharmacy Practice*. 2022;35(6):947-51. doi: 10.1177/08971900211009650. PMID:
437 33840294.
- 438 5. Goyal L, Zapata M, Ajmera K, Chaurasia P, Pandit R, Pandit T. A Hitchhiker's Guide to
439 worldwide COVID-19 vaccinations: A detailed review of monovalent and bivalent vaccine
440 schedules, COVID-19 vaccine side effects, and effectiveness against omicron and delta
441 variants. *Cureus*. 2022;14(10):e29837. doi: 10.7759/cureus.29837. PMID: 36204257;
442 PMCID: PMC9527088.
- 443 6. Chatzilena A, Hyams C, Challen R, Marlow R, King J, Adegbite D, et al. Relative vaccine
444 effectiveness of mRNA COVID-19 boosters in people aged at least 75 years during the
445 spring-summer (monovalent vaccine) and autumn-winter (bivalent vaccine) booster

- 446 campaigns: A prospective test negative case-control study, United Kingdom, 2022. Euro
447 Surveill. 2023;28(48):2300173. doi: 10.2807/1560-7917.ES.2023.28.48.2300173. PMID:
448 38037728; PMCID: PMC10690860.
- 449 7. Murray CJL, Piot P. The potential future of the COVID-19 pandemic: Will SARS-CoV-2
450 become a recurrent seasonal infection? JAMA. 2021;325(13):1249-50. doi:
451 10.1001/jama.2021.2828. PMID: 33656519.
- 452 8. US Food and Drug Administration. Coronavirus (COVID-19) update: FDA authorizes
453 changes to simplify use of bivalent mRNA COVID-19 vaccines; 18 April 2023. Available
454 from: [https://www.fda.gov/news-events/press-announcements/coronavirus-covid-19-](https://www.fda.gov/news-events/press-announcements/coronavirus-covid-19-update-fda-authorizes-changes-simplify-use-bivalent-mrna-covid-19-vaccines)
455 [update-fda-authorizes-changes-simplify-use-bivalent-mrna-covid-19-vaccines.](https://www.fda.gov/news-events/press-announcements/coronavirus-covid-19-update-fda-authorizes-changes-simplify-use-bivalent-mrna-covid-19-vaccines)
- 456 9. European Centre for Disease Prevention and Control, European Medicines Agency.
457 ECDC-EMA statement on updating COVID-19 vaccines composition for new SARS-CoV-2
458 virus variants; 6 June 2023. Available from:
459 [https://www.ema.europa.eu/system/files/documents/other/ecdc-](https://www.ema.europa.eu/system/files/documents/other/ecdc-ema_statement_on Updating COVID-19 vaccines composition for new SARS-CoV-2 virus variants_en.pdf)
460 [ema_statement_on Updating COVID-19 vaccines composition for new SARS-cov-](https://www.ema.europa.eu/system/files/documents/other/ecdc-ema_statement_on Updating COVID-19 vaccines composition for new SARS-CoV-2 virus variants_en.pdf)
461 [2_virus_variants_en.pdf.](https://www.ema.europa.eu/system/files/documents/other/ecdc-ema_statement_on Updating COVID-19 vaccines composition for new SARS-CoV-2 virus variants_en.pdf)
- 462 10. Regan JJ, Moulia DL, Link-Gelles R, Godfrey M, Mak J, Najdowski M, et al. Use of
463 updated COVID-19 vaccines 2023-2024 formula for persons aged ≥ 6 months:
464 Recommendations of the Advisory Committee on Immunization Practices - United States,
465 September 2023. MMWR Morb Mortal Wkly Rep. 2023;72(42):1140-6. doi:
466 10.15585/mmwr.mm7242e1. PMID: 37856366; PMCID: PMC10602621.
- 467 11. European Medicines Agency. News: ETF recommends updating COVID-19 vaccines to
468 target new JN.1 variant; 30 April 2024. Available from:

- 469 [https://www.ema.europa.eu/en/news/etf-recommends-updating-covid-19-vaccines-target-](https://www.ema.europa.eu/en/news/etf-recommends-updating-covid-19-vaccines-target-new-jn1-variant)
470 [new-jn1-variant.](https://www.ema.europa.eu/en/news/etf-recommends-updating-covid-19-vaccines-target-new-jn1-variant)
- 471 12. US Food and Drug Administration. Updated COVID-19 vaccines for use in the United
472 States beginning in Fall 2024; 5 June 2024. Available from: [https://www.fda.gov/vaccines-](https://www.fda.gov/vaccines-blood-biologics/updated-covid-19-vaccines-use-united-states-beginning-fall-2024)
473 [blood-biologics/updated-covid-19-vaccines-use-united-states-beginning-fall-2024.](https://www.fda.gov/vaccines-blood-biologics/updated-covid-19-vaccines-use-united-states-beginning-fall-2024)
- 474 13. Yabuta M, Takeshita F, Ueno S, Tanaka N, Yano T, Oe K, et al. Development of an
475 mRNA vaccine against COVID-19. *Trans Regulat Sci.* 2021;3(3):118-9. doi:
476 10.33611/trs.2021-020.
- 477 14. Toyama K, Eto T, Takazawa K, Shimizu S, Nakayama T, Furihata K, et al. DS-5670a, a
478 novel mRNA-encapsulated lipid nanoparticle vaccine against severe acute respiratory
479 syndrome coronavirus 2: Results from a phase 2 clinical study. *Vaccine.*
480 2023;41(38):5525-34. doi: 10.1016/j.vaccine.2023.07.012. PMID: 37586958.
- 481 15. Suzuki R, Suda M, Ishida K, Furihata K, Ota A, Takahashii K, et al. Booster vaccination
482 using bivalent DS-5670a/b is safe and immunogenic against SARS-CoV-2 variants in
483 children aged 5-11 years: A phase 2/3, randomized, active-controlled study. *Front*
484 *Immunol.* 2024;15:doi:10.3389/fimmu.2024.1445459. doi: 10.3389/fimmu.2024.1445459.
- 485 16. Daiichi-Sankyo. Press release: Daichirona® for intramuscular injection for booster
486 vaccination approved in Japan as omicron XBB.1.5-adapted monovalent mRNA vaccine
487 against COVID-19; 28 November 2023. Available from:
488 [https://www.daiichisankyo.com/files/news/pressrelease/pdf/202311/20231128_E.pdf.](https://www.daiichisankyo.com/files/news/pressrelease/pdf/202311/20231128_E.pdf)
- 489 17. Xu K, Wang Z, Qin M, Gao Y, Luo N, Xie W, et al. A systematic review and meta-analysis
490 of the effectiveness and safety of COVID-19 vaccination in older adults. *Front Immunol.*

- 491 2023;14:1113156. doi: 10.3389/fimmu.2023.1113156. PMID: 36936964; PMCID:
492 PMC10020204.
- 493 18. Mimura W, Ishiguro C, Terada-Hirashima J, Matsunaga N, Sato S, Kawazoe Y, et al.
494 Effectiveness of BNT162b2 against infection, symptomatic infection, and hospitalization
495 among older adults aged ≥ 65 years during the delta variant predominance in Japan: The
496 VENUS study. *J Epidemiol.* 2024;34(6):278-85. doi: 10.2188/jea.JE20230106. PMID:
497 37743530; PMCID: PMC11078592.
- 498 19. McGrew S, Taylor HA. Adolescents, parents, and COVID-19 vaccination - Who should
499 decide? *N Engl J Med.* 2022;386(2):e2. doi: 10.1056/NEJMp2116771. PMID: 34965336.
- 500 20. Japan Ministry of Internal Affairs and Communications. Statistics Topic No. 138: Japan's
501 elderly seen from statistics (Respect for the Aged Day); 18 September 2023. Available
502 from: https://www.stat.go.jp/data/topics/pdf/topi138_01.pdf.
- 503 21. Hasegawa T, Hirata K, Matsumoto K. Lessons from the COVID-19 pandemic: Strategies
504 and challenges for an aging society in Japan. *Public Administration and Policy: An Asia-*
505 *Pacific Journal.* 2023;26(1):21-35. doi: 10.1108/PAP-10-2022-0123.
- 506 22. Flanagan KL, Fink AL, Plebanski M, Klein SL. Sex and gender differences in the
507 outcomes of vaccination over the life course. *Annu Rev Cell Dev Biol.* 2017;33:577-99.
508 doi: 10.1146/annurev-cellbio-100616-060718. PMID: 28992436.
- 509 23. Ciarambino T, Barbagelata E, Corbi G, Ambrosino I, Politi C, Lavallo F, et al. Gender
510 differences in vaccine therapy: Where are we in COVID-19 pandemic? *Monaldi Arch*
511 *Chest Dis.* 2021;91(4):1669. doi: 10.4081/monaldi.2021.1669. PMID: 33840183.

- 512 24. Kouhpayeh H, Ansari H. Adverse events following COVID-19 vaccination: A systematic
513 review and meta-analysis. *Int Immunopharmacol.* 2022;109:108906. Epub 20220530. doi:
514 10.1016/j.intimp.2022.108906. PMID: 35671640; PMCID: PMC9148928.
- 515 25. Rabail R, Ahmed W, Ilyas M, Rajoka MSR, Hassoun A, Khalid AR, et al. The side effects
516 and adverse clinical cases reported after COVID-19 immunization. *Vaccines (Basel).*
517 2022;10(4):488. doi: 10.3390/vaccines10040488. PMID: 35455237; PMCID:
518 PMC9031559.
- 519

Fig. 1A

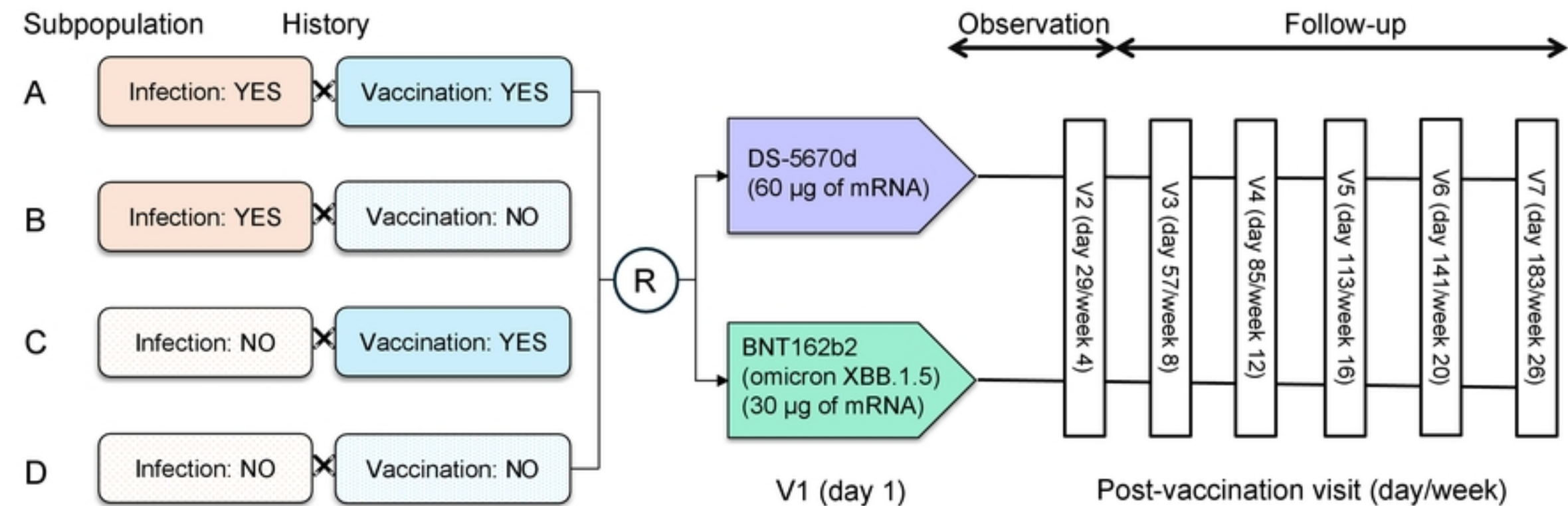

Fig. 1B

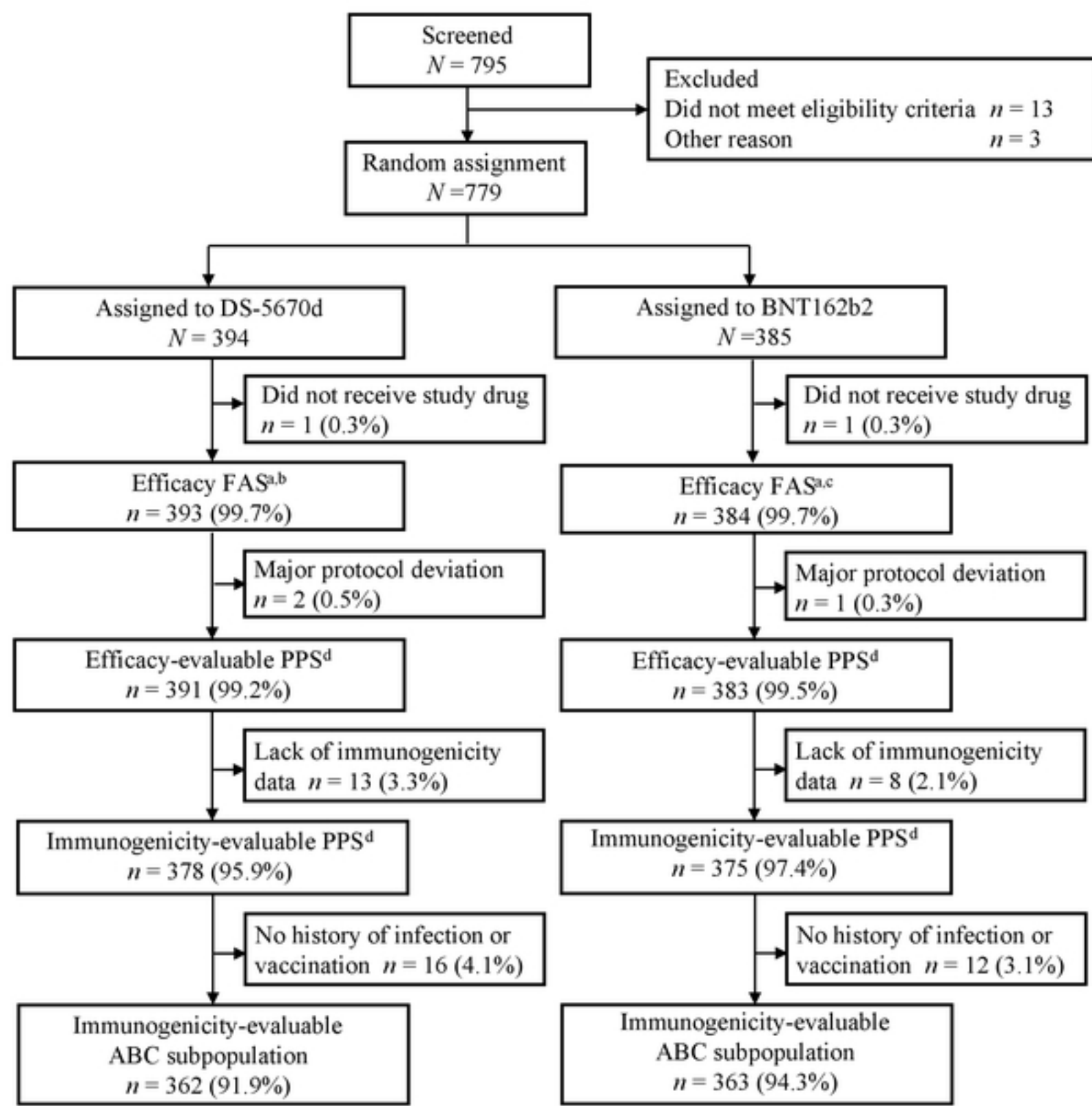

Fig. 2A

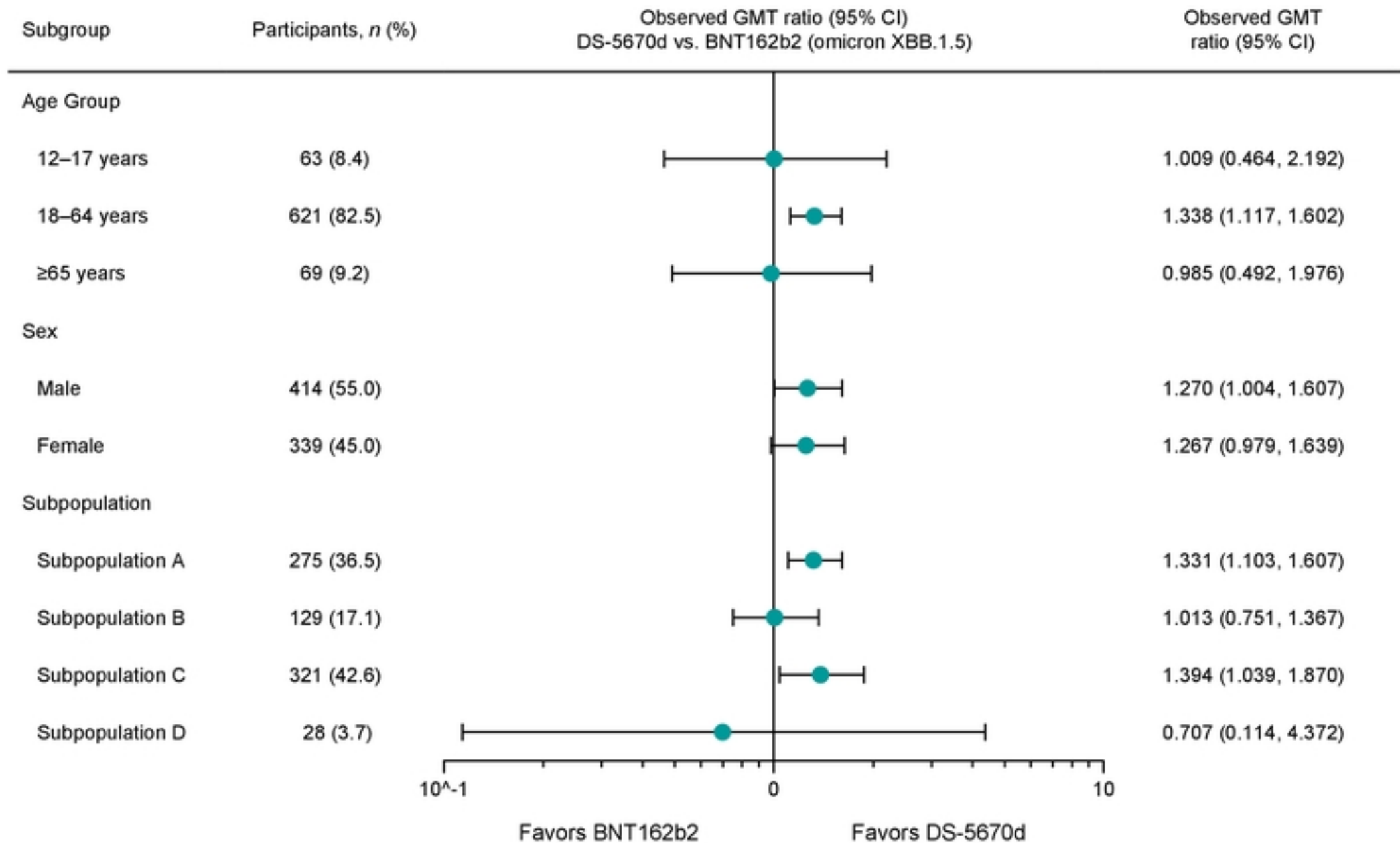

Fig. 2B

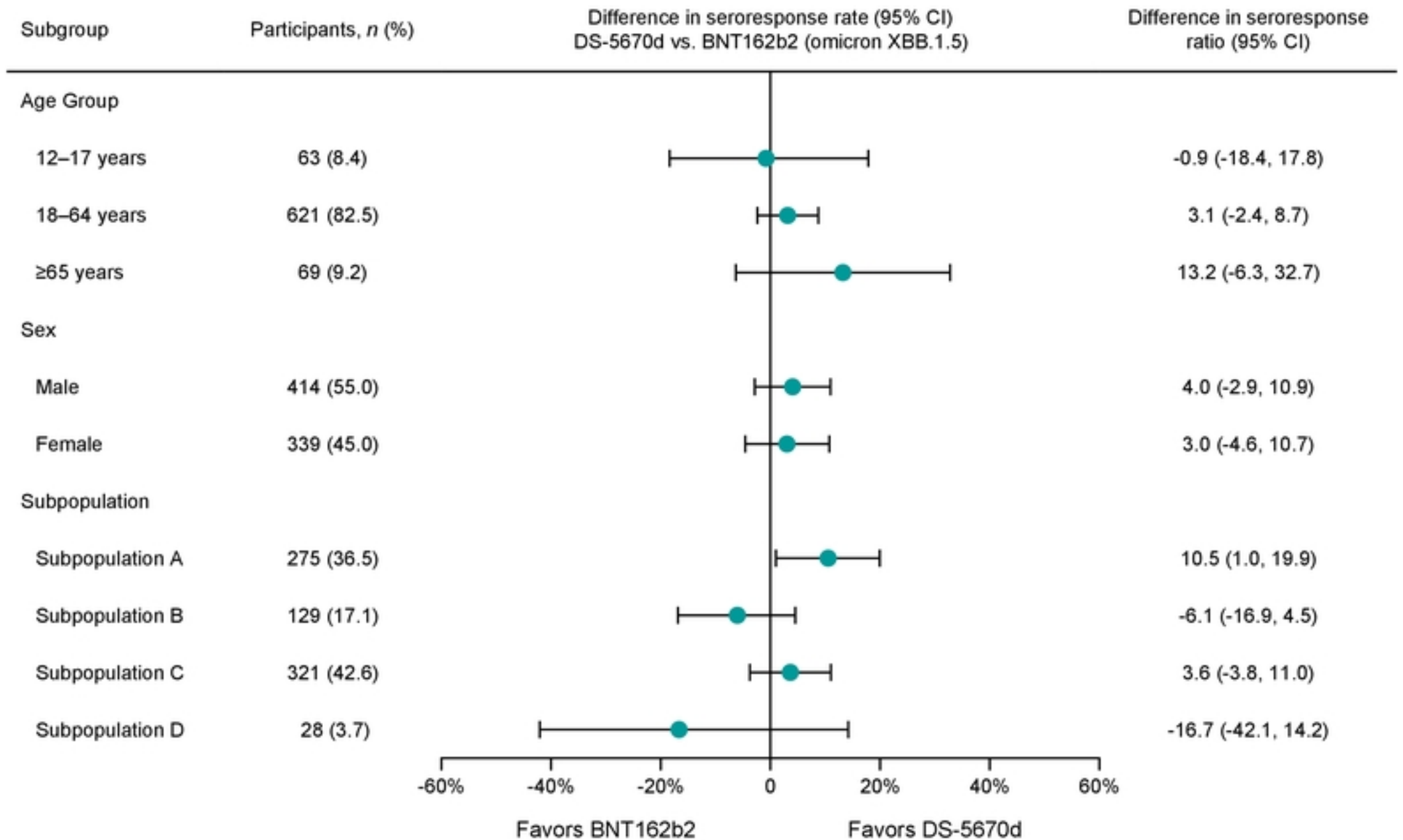

Fig. 3

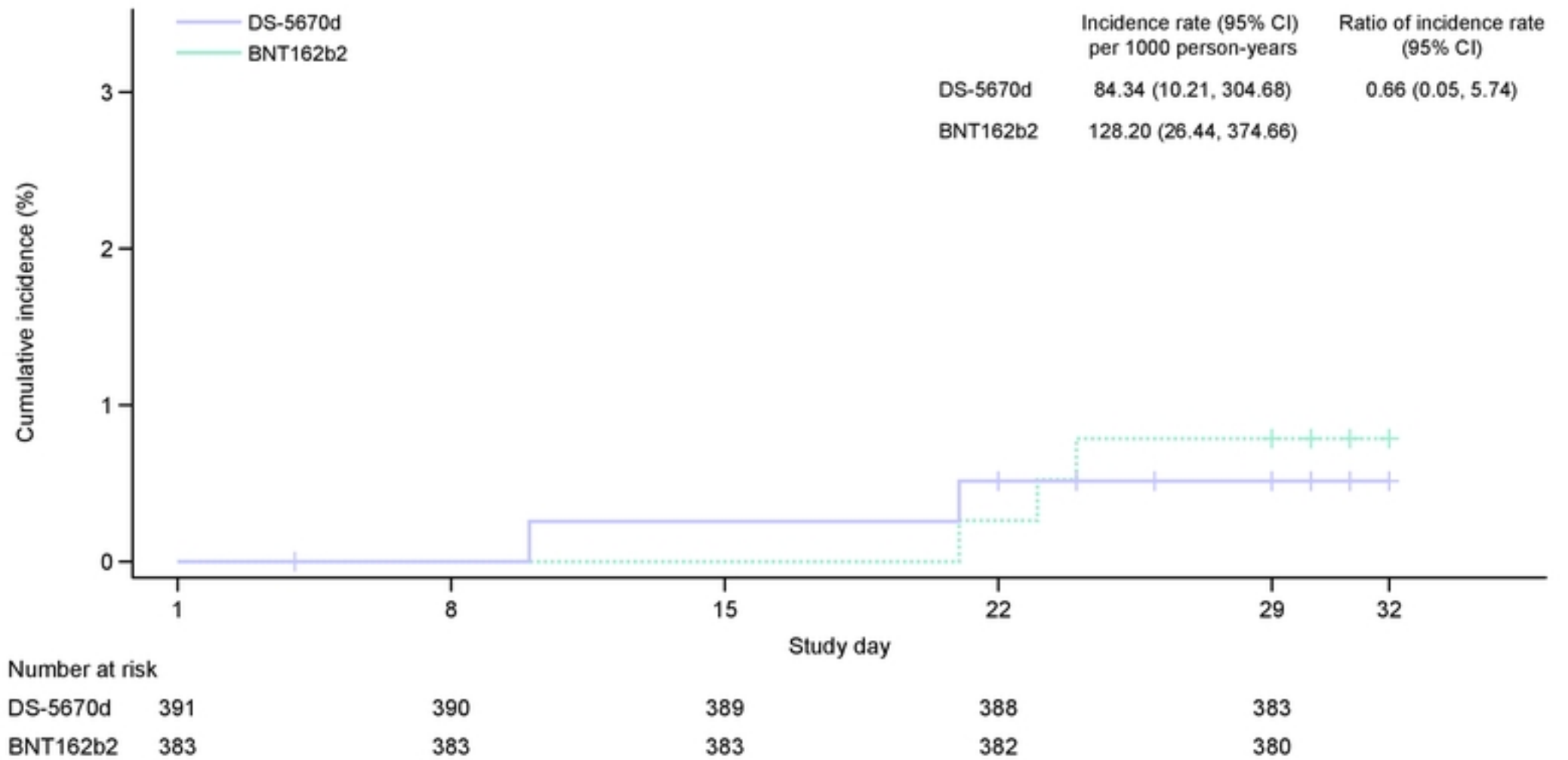
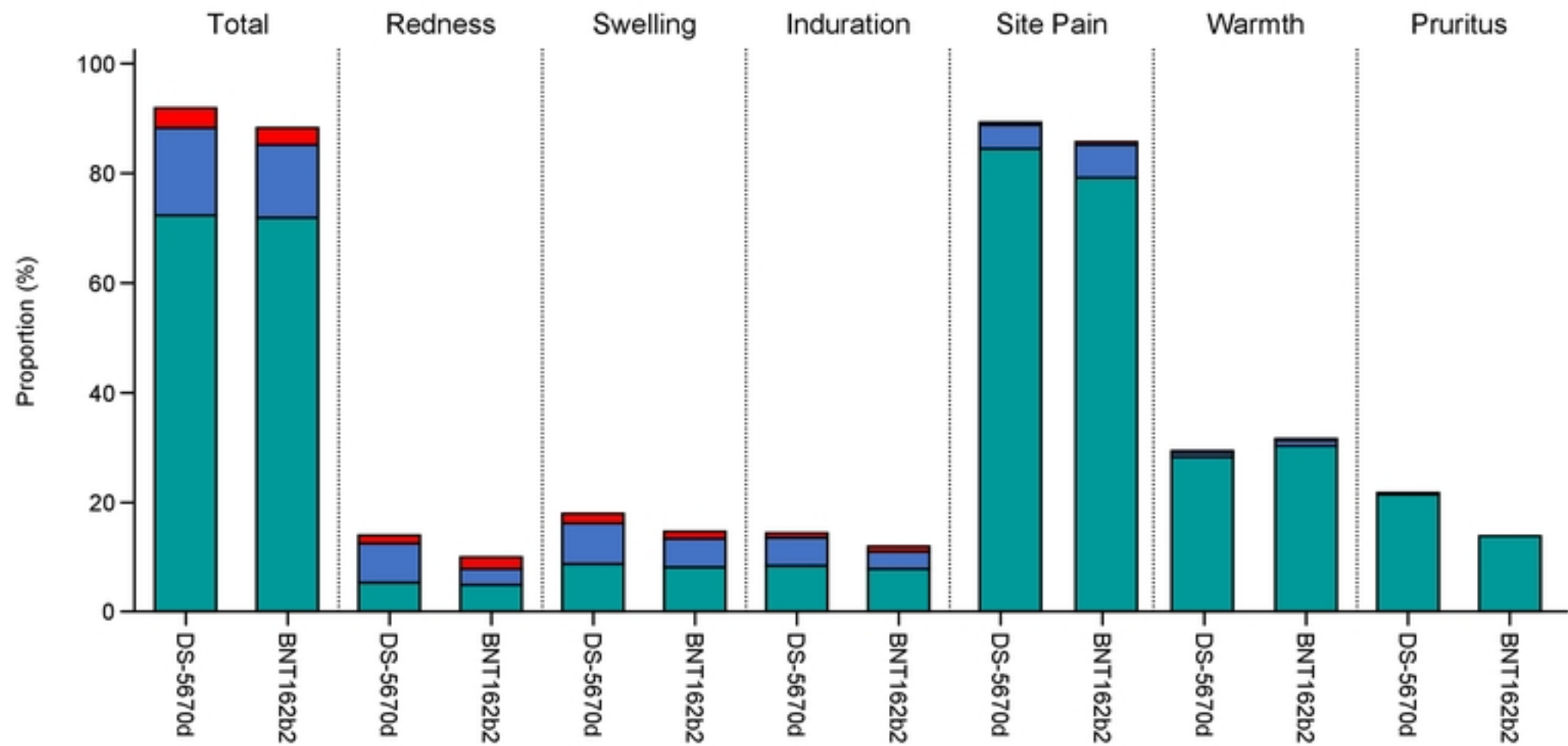

Fig. 4A





Total (%)	91.9%	88.3%	14.0%	9.9%	17.8%	14.6%	14.2%	12.0%	89.3%	85.7%	29.3%	31.5%	21.6%	13.8%
Severe 	3.6%	3.1%	1.5%	2.1%	1.8%	1.3%	0.8%	1.0%	0.5%	0.5%	0.3%	0.3%	0%	0%
Moderate 	16.0%	13.3%	7.1%	2.9%	7.4%	5.2%	5.1%	3.1%	4.3%	6.0%	0.8%	1.0%	0.3%	0%
Mild 	72.3%	71.9%	5.3%	4.9%	8.7%	8.1%	8.4%	7.8%	84.5%	79.2%	28.2%	30.2%	21.4%	13.8%

Fig. 4B



Total (%)	46.6%	46.9%	16.0%	16.7%	30.5%	35.9%	17.8%	24.7%	1.0%	1.0%	17.3%	19.0%
Severe ■	1.8%	2.6%	0.5%	0.8%	0.8%	1.3%	0.8%	0.8%	0%	0%	0.3%	0.3%
Moderate ■	5.9%	8.3%	1.8%	3.9%	2.8%	6.3%	2.3%	3.1%	0.3%	0%	1.3%	2.9%
Mild ■	38.9%	35.9%	13.7%	12.0%	27.0%	28.4%	14.8%	20.8%	0.8%	1.0%	15.8%	15.9%

Table 2

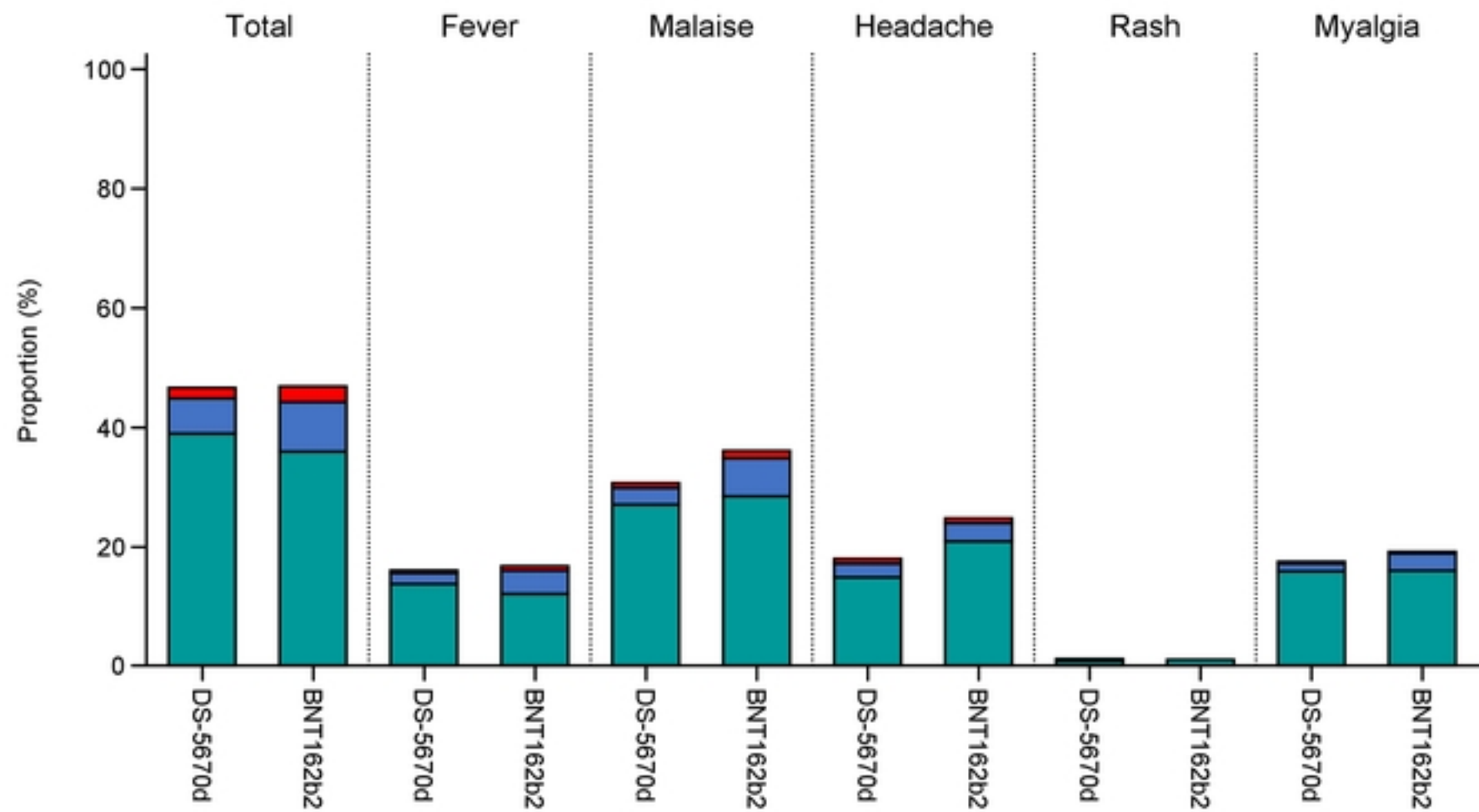