

1 Comprehensive analysis of key m6A RNA modification-related  
2 genes and immune infiltrates in hypertrophic cardiomyopathy

3 Xia Hu<sup>1</sup>, Bo Liang<sup>2</sup>

4 1. Shanghai Jiaotong University, Shanghai, China

5 2. Xinqiao Hospital ,Chongqing, China

6 Correspondence: Dr. Bo Liang

7

8 Abstract

9 Hypertrophic cardiomyopathy (HCM) is the most common inherited heart disease.  
10 We performed a comprehensive analysis to construct the correlation of m6A and  
11 immune in HCM. Two HCM datasets (GSE141910 and GSE160997) and m6A-  
12 related regulators were obtained from GEO and published articles, respectively.  
13 Differentially expressed m6A-related regulators were obtained. Random forest model  
14 and nomogram were conducted to assess the risk of HCM, and finally, the m6A  
15 subtype was constructed. Functional enrichment analysis was conducted. Protein-  
16 protein interaction network of differentially expressed genes between m6A subtypes  
17 was performed. Furthermore, we constructed the Hubgene-chemical network,  
18 Hubgene-microRNA network, and Hubgene-transcription factor network of the top 10  
19 hubgenes. Additionally, the immune subtype and hubgene subtype were constructed.  
20 PCR was performed to validate the m6A-related regulators. We obtained 20 m6A-  
21 related regulators in HCM. Among them, 8 m6A-related regulators differentially  
22 expressed (YTHDC1, HNRNPC, and FMR1 were up-regulated while YTHDC2, FTO,  
23 WTAP, IGF2BP2, and IGF2BP3 were down-regulated). FTO, FMR1, IGF2BP3,  
24 YTHDC1, and IGF2BP2 were the top 5 important m6A-related regulators and were  
25 used to conduct the nomogram. We obtained 329 differentially expressed genes in  
26 m6A subtype and these genes enriched HCM-related processes and pathways.  
27 Furthermore, we constructed the Hubgene-chemical network, Hubgene-microRNA

28 network, and Hubgene-transcription factor network of the top 10 hubgenes (NFKBIA,  
29 NFKB1, PSMA3, PSMC4, PSMA2, PSMA4, PSMD7, PSMD10, PSMD8, and  
30 PSMA6). And then we constructed an immune subtype based on the immune cell  
31 infiltration levels and hubgene subtype based on the expression of the top 10  
32 hubgenes. Finally, we verified the main results through experiments. In conclusion,  
33 we built a nomogram and identified 8 m6A-related regulators and 10 hubgenes, which  
34 were prominently associated with HCM. We found that m6A and the immune system  
35 may play a crucial role in the HCM. Accordingly, those genes and pathways might  
36 become therapeutic targets with clinical usefulness in the future.

37

38

39

40 **Keywords:** Hypertrophic cardiomyopathy; Epigenetics; N6-methyladenosine;  
41 Immune; Bioinformatics

## 42 1. Introduction

43 Hypertrophic cardiomyopathy (HCM) is the commonest primitive inherited disease of  
44 the myocardium[1], with an autosomal dominant pattern of inheritance and a  
45 worldwide prevalence of approximately one in 500 adult subjects[2, 3]. HCM is  
46 defined principally by left ventricular hypertrophy without increased cardiac afterload  
47 or another underlying pathophysiological etiology, and causes heart failure at any  
48 age[4]. A clinical diagnosis of HCM in adults can be established by imaging with 2D  
49 echocardiography or cardiovascular magnetic resonance[5]. According to the latest  
50 guidelines[2, 3], pharmacological therapy for HCM patients includes non-selective  
51 drugs such as  $\beta$ -blockers, cardiac-selective calcium antagonists, and disopyramide, to  
52 be used in symptomatic patients with obstruction of the left ventricular outflow tract.  
53 Current drugs are unable to address the pathophysiological mechanisms of left  
54 ventricular dysfunction in HCM and are not, therefore, effective in preventing  
55 arrhythmias or slowing down disease progression in HCM patients[1]. Novel  
56 allosteric inhibitors of myosin are being developed and clinically validated,  
57 specifically targeting HCM-related pathophysiological mechanisms, such as  
58 myocardial hypercontractility and altered energetics[6]. However, HCM is a  
59 heterogeneous disease that involves numerous sarcomere-independent morphological  
60 features, suggesting that the precise mechanisms of HCM have not been fully  
61 elucidated.

62 Epigenetic dysregulation is crucial for the pathological development of cardiovascular  
63 diseases[7, 8]. N6-methyladenosine (m6A) is the most common post-transcriptional  
64 modification of mRNA[9] and has recently attracted great attention. m6A influences a  
65 series of biological functions in cardiovascular diseases. m6A RNA modification  
66 mediates the atherogenic inflammatory cascades in vascular endothelium[10] and  
67 modulates endothelial atherogenic responses to disturbed flow in mice[11]. Age-  
68 related differences in m6A in response to acute myocardial ischemia/reperfusion  
69 injury[12] and m6A might play important roles in blood pressure regulation[13]. m6A

70 modification effectively improves the cardiac function and decreases the infarct size  
71 in acute myocardial infarction through tricarboxylic acid cycle-based metabolic  
72 reprogramming[14] and promotes miR-133a repression during cardiac development  
73 and hypertrophy via IGF2BP2[15]. In heart failure, FTO-dependent cardiac m6A  
74 methylome plays a functional importance in cardiac contraction[16] and m6A might  
75 be an interesting target for therapeutic interventions[17]. However, the role of m6A in  
76 HCM is largely unknown.

77 m6A RNA modification acts as a novel regulator in both innate and adaptive immune  
78 response[18, 19]. In acute myocardial infarction and aortic dissection, m6A is closely  
79 connected to immune cell infiltration[20, 21]. Previous study showed that the changes  
80 in the immune system engage in the HCM mechanisms[22, 23] and the systemic  
81 immune-inflammation index is a significant risk factor for all-cause mortality in HCM  
82 patients[24]. All these evidence supports immune response has a significant impact on  
83 the HCM biology and outcome. However, the crosstalk between m6A and immune  
84 response in HCM is poorly understood. In this study, we comprehensively evaluated  
85 the expression of m6A-related regulators and immune cell infiltration in HCM  
86 patients from two independent cohorts, constructed random forest model and  
87 nomogram, and further identified m6A and immune subtype (Figure 1).

88

## 89 2. Methods

### 90 2.1 Data collection

91 Two HCM datasets from GEO, namely GSE141910 and GSE160997[25], were  
92 obtained through the *GEOquery* package and details are shown in Table 1. All samples  
93 were pooled after removing batch effects (Figure S1), as described previously[26, 27].  
94 In addition, m6A-related regulators were extracted based on published literature.

### 95 2.2 m6A-related regulators in HCM

96 The chromosomal locations of m6A-related regulators were visualized using the  
97 *RCircos* package and the differential expression levels of m6A-related regulators  
98 between HCM patients and the controls were analyzed using the *limma* package.

99 Finally, linear regression analysis was used to explore the correlation between m6A  
100 writers and m6A erasers.

### 101 2.3 Construction of random forest model and nomogram

102 Random forest is a compositionally supervised learning method that can be viewed as  
103 an extension of decision tree[28]. We divided patients with HCM into the training  
104 cohort and the validation cohort by 7:3, and selected candidate m6A regulators from  
105 all m6A-related regulators to predict the occurrence of HCM. We built the random  
106 forest model in the training cohort with  $n_{trees} = 500$ , and then analyzed the  
107 importance of m6A-related regulators and evaluated the model with residual analysis  
108 and ROC curves on both training and validation cohorts.

109 We constructed a nomogram based on the top 5 candidate m6A regulators using the  
110 *rms* package to predict the prevalence of HCM patients. Calibration curve, decision  
111 curve analysis, and ROC curve were conducted to evaluate the nomogram, as  
112 described previously[29, 30]. Finally, we explored the correlation between top 5  
113 candidate m6A regulators and immune-related cell types.

### 114 2.4 m6A subtype construction

115 We used the *ConsensusClusterPlus* package[31] to identify the membership and  
116 number of clusters in datasets based on the expression of the top 5 m6A-related  
117 regulators. Then individuals were clustered into corresponding clusters. We further  
118 analyzed the expression of the top 10 hubgenes in corresponding clusters. The  
119 differentially expressed genes among clusters were analyzed using the *limma* package  
120 with a threshold of adjusted  $P < 0.05$  and  $|\log_2\text{Fold Change}| > 2$  and the *ggplot2*  
121 package[26] was used to visualization.

122 We used the *clusterProfiler* package[32] to perform gene ontology (including cellular  
123 component, molecular function, and biological process) and Kyoto Encyclopedia of  
124 Genes and Genomes enrichment analysis on differentially expressed genes with a  
125 threshold of  $P < 0.5$  and false discovery rate  $< 0.05$ . The specific Kyoto Encyclopedia  
126 of Genes and Genomes terms were visualized through the *Pathview* package[33].  
127 Gene sets of *c2.cp.v7.4.symbols.gmt*, which are curated from various sources,

128 including online pathway databases and the biomedical literature, were downloaded  
129 from Molecular Signatures Database[34] as background for gene set enrichment  
130 analysis[35]. Adjusted  $P < 0.05$  was considered statistically significant.

131 The STRING database[36] was used for protein-protein interaction analysis of  
132 differentially expressed genes, and those genes with a score greater than 0.6 were  
133 selected for later analysis. The *cytoHubba* plugin[37] in Cytoscape[38] was used to  
134 functionally enrich the cluster from the protein-protein interaction network to obtain  
135 the hubgenes. Furthermore, we constructed Hubgene-chemical network, Hubgene-  
136 microRNA network, and Hubgene-transcription factor network of the top 10  
137 hubgenes obtained based on the protein-protein interaction network.  
138 NetworkAnalyst[39] was used to build Hubgene-chemical network and Hubgene-  
139 chemical network, and miRTarBase[40] was used to build Hubgene-microRNA  
140 network. Cytoscape[38] was used for visualization.

## 141 2.5 Immune subtype construction

142 We calculated the immune cell infiltration levels using the *ssGSEA* function of the  
143 *GSEA* package to obtain the enrichment score for each immune-related cell type.  
144 Subtype classification was further constructed based on the enrichment score features  
145 of immune-related cell types using the *ConsensusClusterPlus* package[31]. Then  
146 individuals were clustered into corresponding clusters. The differentially expressed  
147 genes among clusters were analyzed using the *limma* package with a threshold of  
148 adjusted  $P < 0.05$  and  $|\log_2\text{Fold Change}| > 2$  and the *ggplot2* package[26] was used to  
149 visualization. We further analyzed the difference and correlation between top 10  
150 hubgenes and immune infiltration.

151 CIBERSORT is a method for characterizing cell composition of complex tissues from  
152 their gene expression profiles[41]. We obtained immune cell infiltration matrix by  
153 CIBERSORT with  $P < 0.05$  as threshold. The *ggplot2* package[26] and *corrplot*  
154 package were used to visualization. We further analyzed the correlation between top  
155 10 hubgenes and immune cells.

## 156 2.6 Hubgene subtype construction

157 Subtype classification was constructed based on the expression of top 10 hubgenes  
158 using the *ConsensusClusterPlus* package[31]. Then individuals were clustered into  
159 corresponding clusters. We further analyzed the expression of top 10 hubgenes in  
160 corresponding clusters.

## 161 2.7 Experimental Validation

162 The 8-week-old C57BL/6J mice were obtained from Vital River (Beijing, China) and  
163 all animal experiments were reviewed and approved by the Experimental Animal  
164 Center of Zhengzhou University (Zhengzhou, China) (ZZU-LAC20220311[23]). We  
165 conducted transverse aortic constriction (TAC) to build the myocardial hypertrophy  
166 model[42]. A total of 12 male mice were divided into the Sham group (N = 6) and the  
167 TAC group (N = 6). After four weeks of TAC, the mice were sacrificed after  
168 transthoracic echocardiography for the following experiments. Histomorphological  
169 changes in the heart were determined by HE and WGA staining according to our  
170 previous protocol[43, 44]. The mRNA expression of atrial natriuretic peptide (Anp),  
171 brain natriuretic peptide (Bnp), myosin heavy chain 7 (Myh7), Hnrnpc, Fmr1, and Fto  
172 in the heart tissue was quantified by real-time quantitative polymerase chain reaction  
173 assay according to our previous protocol[43, 44]. The primer sequences are listed in  
174 Table S1.

175

## 176 2.8 Statistical analysis

177 The experimental data are expressed as the mean and standard deviation and were  
178 analyzed by Prism (version 9.5.0, GraphPad, CA, USA) with a t test and one-way  
179 analysis of variance if applicable.  $P < 0.05$  was considered statistically significant.

180 All data processing and analysis were completed through R (version 4.1.0) with  
181 independent Student t test, Mann Whitney U test (Wilcoxon rank sum test), Chi  
182 square test or Fisher exact test, if applicable. All  $P < 0.05$  bilaterally was considered  
183 statistically significant.

### 184 3. Results

#### 185 3.1 m6A-related regulators in HCM

186 We obtained 20 m6A-related regulators in HCM. Among them, there were 6 writers  
187 (METTL3, ZC3H13, METTL14, CBLL1, WTAP, and RBM15), 2 erasers (FTO and  
188 ALKBH5), and 12 readers (YTHDC1, YTHDC2, ELAVL1, YTHDF1, LRPPRC,  
189 YTHDF2, FMR1, YTHDF3, HNRNPC, HNRNPA2B1, IGF2BP2, and IGF2BP3).  
190 The chromosomal locations of 20 m6A-related regulators were shown in Figure 2A.  
191 A total of 8 m6A-related regulators differentially expressed, YTHDC1, HNRNPC,  
192 and FMR1 were up-regulated in HCM and YTHDC2, FTO, WTAP, IGF2BP2, and  
193 IGF2BP3 were down-regulated in HCM (Figure 2B&C). Through linear regression  
194 analysis, we found that the expression of CBLL1, ZC3H13, METTL3, and METTL14  
195 was highly positively correlated with FTO ( $P < 0.05$ ,  $< 0.0001$ ,  $< 0.0001$ , and  $<$   
196  $0.0001$ , respectively), the expression of RBM15 was highly negatively correlated with  
197 FTO ( $P < 0.0001$ ), and the expression of CBLL1 and METTL14 was highly  
198 negatively correlated with ALKBH5 ( $P < 0.001$  and  $< 0.01$ , respectively) (Figure 2D).

199

#### 200 3.2 Random forest model and nomogram

201 In the training cohort, we build the random forest model (Figure 3A). FTO, FMR1,  
202 IGF2BP3, YTHDC1, and IGF2BP2 were top 5 important m6A-related regulators in  
203 HCM (Figure 3B). The residual plots in the training and validation cohorts were  
204 shown in Figure 3C&D ( $P < 0.0001$  and  $< 0.001$ , respectively). Moreover, The ROC  
205 curves indicated that the model performed well (AUC = 1 and 0.86 in the training and  
206 validation cohorts, respectively) (Figure 3E).

207

208 We constructed a nomogram based on top 5 important m6A-related regulators in  
209 HCM (Figure 4A) and calibration curve, decision curve analysis, and ROC curve  
210 showed that the performance of nomogram was acceptable (Figure 4B~D).

211



212 Correlation analysis showed that FMR1 and T cells follicular helper, FTO and B cells  
213 naïve, Monocytes, T cells CD8, T cells regulatory (Tregs), IGF2BP2 and Dendritic  
214 cells resting, T cells gamma delta, T cells regulatory (Tregs), IGF2BP3 and Dendritic  
215 cells activated, Dendritic cells resting, T cells gamma delta, YTHDC1 were strongly  
216 correlated with T cells CD8 (Figure 4-1).

217

### 218 3.3 m6A subtype construction

219 When  $k = 2$ , the classification was reliable and stable (Figure 5A~F). Among 10  
220 hubgenes, NFKB1, PSMC4, PSMA4, PSMA2, and PSMA6 were dys-regulated in  
221 ClusterA and ClusterB ( $P < 0.001$ ,  $< 0.01$ ,  $< 0.001$ ,  $< 0.01$ , and  $< 0.001$ , respectively)  
222 (Figure 5). Therefore, we divided the samples into ClusterA and ClusterB. Further, we  
223 obtained 329 differentially expressed genes (154 genes were up-regulated and 175  
224 genes were down-regulate) (Figure 5G&H).

225

226 Through enrichment analysis of 329 differentially expressed genes, we found that  
227 homophilic cell adhesion via plasma membrane adhesion molecules, positive  
228 regulation of necrotic cell death, respiratory electron transport chain, glycosylation,  
229 necrotic cell death, regulation of necrotic cell death, energy derivation by oxidation of  
230 organic compounds, mitochondrial ATP synthesis coupled electron transport, cellular  
231 response to osmotic stress, and positive regulation of amino acid transport were  
232 enriched in biological process; endocytic vesicle lumen, autolysosome, respiratory  
233 chain complex, Golgi cis cisterna, haptoglobin-hemoglobin complex, mitochondrial  
234 respirasome, mitochondrial respiratory chain complex IV, hemoglobin complex,  
235 Golgi cisterna membrane, and ficolin-1-rich granule membrane were enriched in  
236 cellular component; Rac GTPase binding, fibronectin binding, inorganic anion  
237 transmembrane transporter activity, intramolecular transferase activity,  
238 phosphotransferases, haptoglobin binding, RAGE receptor binding, pre-mRNA  
239 intronic binding, copper ion binding, oxygen binding, and oxygen carrier activity,  
240 were enriched in molecular function (Figure 6A). Calcium signaling pathway,

241 Sphingolipid metabolism, Gastric acid secretion, Leukocyte transendothelial  
242 migration, Neuroactive ligand-receptor interaction, Malaria, and Proximal tubule  
243 bicarbonate reclamation were enriched in Kyoto Encyclopedia of Genes and Genomes  
244 (Figure 6B). Calcium signaling pathway and Leukocyte transendothelial migration  
245 were visualized in Figure 6C&D. Through gene set enrichment analysis, pathways  
246 related to infection, oxidative stress, immunity, and amino acid metabolism were  
247 enriched (Figure 6E).

248

249 Through protein-protein interaction analysis of 329 differentially expressed genes, we  
250 obtained a network consisting of 143 genes and 184 connections (Figure 7A). Next,  
251 we got sub-networks consisting of the top 20 and 10 genes (Figure 7B&C).

252

253 Furthermore, we constructed Hubgene-chemical network, Hubgene-microRNA  
254 network, and Hubgene-transcription factor network of the top 10 hubgenes. Hubgene-  
255 chemical network included 574 nodes (10 hubgenes and 564 chemicals) and 837  
256 edges (Figure 8A), Hubgene-microRNA network included 131 nodes (9 hubgenes and  
257 121 microRNAs) and 132 edges (Figure 8B), Hubgene-transcription factor network  
258 included 181 nodes (10 hubgenes and 171 transcription factors) and 284 edges (Figure  
259 8C).

260

### 261 3.4 Immune subtype construction

262 When  $k = 2$ , the classification was reliable and stable (Figure 9A~D). Therefore, we  
263 divided the samples into ImmuClusterA and ImmuClusterB. Further, we obtained 50  
264 differentially expressed genes (15 genes were up-regulated and 35 genes were down-  
265 regulated) (Figure 9E). Among top 10 hubgenes, NFKB1, PSMD10, and PSMA6  
266 negatively correlated with most immune cell infiltration and PSMC4 and PSMA4  
267 positively correlated with most immune cell infiltration (Figure 9F). Interestingly,  
268 NFKB1, PSMD10, PSMA6, PSMC4, and PSMA4 were dys-regulated in

269 ImmuClusterA and ImmuClusterB ( $P < 0.001$ ,  $< 0.01$ ,  $< 0.001$ ,  $< 0.01$ , and  $< 0.01$ ,  
270 respectively) (Figure 9G), suggesting these genes may be immune-related targets.

271

272 We used the CIBERSORT algorithm to analyze the proportion of immune subsets in  
273 patients with HCM, and constructed a map of 22 immune cells in HCM (Figure 10A)  
274 and the correlation of 22 immune cells (Figure 10B). We analyzed the correlation  
275 between top 10 hubgenes and immune cells, and found that NFKB1 was negatively  
276 correlated with CD8<sup>+</sup> T cells and T regulatory cells (Figure 10 C&D), PSMA4 was  
277 negatively correlated with B naïve cells and positively correlated CD8<sup>+</sup> T cells  
278 (Figure 10E&F), PSMA6 was negatively correlated with mast cells and T regulatory  
279 cells (Figure 10 G&H), PSMC4 was positively correlated T follicular helper cells and  
280 negatively correlated with T gamma delta cells (Figure 10 I&J), PSMD7 and PSMD8  
281 were negatively correlated with T gamma delta cells (Figure 10 K&L) PSMD10 was  
282 negatively correlated with and T regulatory cells (Figure 10 M).

283

### 284 3.5 Hubgene subtype construction

285 When  $k = 2$ , the classification was reliable and stable (Figure 11A~E). We divided the  
286 samples into GeneClusterA and GeneClusterB. And through principal component  
287 analysis, it was found that the classification was significantly different (Figure 11F).  
288 Among 10 hubgenes, NFKB1, PSMA4, and PSMA6 were dys-regulated between  
289 GeneClusterA and GeneClusterB ( $P < 0.001$ ,  $< 0.01$ , and  $< 0.001$ , respectively)  
290 (Figure 11G).

291

### 292 3.6 Experimental Validation

293

294 Relative mRNA levels of hypertrophy marker genes (ANP, BNP, and MYH7) and  
295 Hnrnpc, Fmr1, Fto in heart tissues from mice at four weeks after sham operations or  
296 TAC surgery (n=6). For statistical analysis, nonparametric statistical analysis was  
297 performed using the Mann-Whitney test for two groups.

## 298 4. Discussion

299 HCM is mainly caused by the mutations in sarcomere genes[45]. Relevant genetic  
300 testing has been recommended by guidelines and has promoted the diagnosis of HCM  
301 to a certain extent. However, more and more studies show that the clinical  
302 characteristics observed in patients with HCM is not all caused by abnormal  
303 sarcomeric proteins[2, 46, 47]. Therefore, it is necessary to explore alternative  
304 molecular mechanisms of HCM and identify more valuable biomarkers by utilizing  
305 contemporary methods to analyze biological complexity[48]. Here, we firstly  
306 identified 20 m6A-related regulators in HCM and constructed the m6A, immune, and  
307 hubgene subtypes. Finally, the key findings were validated the molecular biology  
308 experiments.

309 m6A is required for the formation of a nuclear body mediated by phase separation that  
310 maintains mRNA stability[49]. YTHDC1 mediates export of methylated mRNA from  
311 the nucleus to the cytoplasm and knockdown of YTHDC1 results in an extended  
312 residence time for nuclear m6A-containing mRNA, with an accumulation of  
313 transcripts in the nucleus and accompanying depletion within the cytoplasm[50].  
314 YTHDC2 is a powerful endogenous ferroptosis inducer and targets SLC3A2 and  
315 SLC7A11[51, 52]. HNRNPC is attributed to the function of controlling the  
316 endogenous double-stranded RNA and the downstream interferon response[53].  
317 Sequence-specific mRNAs instruct FMR1-ribonucleoprotein granules to undergo a  
318 dynamic phase switch, thus contributing to maternal mRNA decay. FTO mediated the  
319 m6A level of LINC00022 and MALAT to promote the tumorigenesis[54, 55].  
320 WTAP-guided m6A modification contributes to the progression of hepatocellular  
321 carcinoma via the HuR-ETS1-p21/p27 axis[56]. IGF2BP2/3 m6A promotes  
322 vasculogenic mimicry in colorectal cancer via PI3K/AKT and ERK1/2 signaling[57]  
323 and attenuates the detrimental effect of irradiation on lung adenocarcinoma[58]. Here,  
324 we found that these m6A-related regulators were differentially expressed in HCM.  
325 Moreover, we illustrated the correlations of certain m6A-related regulators. Then we

326 built the high-fidelity random forest model and used the top 5 important m6A-related  
327 regulators in HCM (namely FTO, FMR1, IGF2BP3, YTHDC1, and IGF2BP2) to  
328 construct the nomogram, which is a good predictor for the risk of HCM. According to  
329 the expression of these 5 m6A-related regulators, we constructed the m6A subtype.  
330 Based on the 329 differential genes of the two subtypes, we enriched many biological  
331 processes and signaling pathways known to be associated with HCM. Activation of  
332 CaMK-signaling pathway may be involved in the pathophysiology of HCM[59]. Post-  
333 translational activation of the CaMKII pathway is specific to sarcomere mutation-  
334 positive HCM, whereas sarcoplasmic endoplasmic reticular calcium ATPase 2  
335 abundance and sarcoplasmic reticulum  $Ca^{2+}$  uptake are depressed in both sarcomere  
336 mutation-positive and -negative HCM[60]. HCM is characterized by enhanced  
337 oxidative stress, which achieves its highest values in the presence of LVOT  
338 obstruction in HCM patients[61] and reducing oxidative stress can be a viable  
339 therapeutic approach to attenuating the severity of cardiac dysfunction in HCM and  
340 prevent its progression[62]. Importantly, we also enriched oxidative stress-related  
341 signaling pathways. After protein-protein interaction of 329 differentially expressed  
342 genes, Hubgene-chemical network, Hubgene-microRNA network, and Hubgene-  
343 transcription factor network of the top 10 hubgenes among 329 differentially  
344 expressed genes were sequentially constructed, which not only provide ideas for the  
345 pathogenesis of HCM, but also give insights into the treatment of HCM.

346 m6A is closely connected to immune cell infiltration[20, 21] and the immune system  
347 engage in the HCM mechanisms[22, 23]. After m6A subtype, we constructed immune  
348 subtype according to the immune cell infiltration levels. We demonstrated the  
349 correlation of some differential genes with immune cell infiltration and various  
350 immune cells, which further deepens the understanding of immunity in the occurrence  
351 and development of HCM. And then hubgene subtype classification was constructed  
352 based on the expression of top 10 hubgenes and NFKB1, PSMA4, and PSMA6 were  
353 dys-regulated between hubgene subtypes.

354 This study establishes a clinically accessible model for predicting HCM risk through  
355 bioinformatics analysis using transcriptome datasets of HCM patients and healthy  
356 controls, and furthers the understanding of the molecular mechanisms of m6A and  
357 immunity in HCM. Nonetheless, our study still has some limitations and inadequacies.  
358 Firstly, although we used different datasets for the analysis, because this was a  
359 reanalysis based on the existing data, we could not fully obtain more pathological,  
360 clinical and prognostic information of the dataset, which led us to build a risk model  
361 later, rather than provide more evidence for treatment or prognosis. In addition, we  
362 constructed different networks, which have a certain role in promoting the  
363 pathogenesis and clinical treatment of HCM. Although we have carried out biological  
364 experiments to verify important results, most of the results we obtained are based on  
365 computer analysis. Many basic experiments and clinical experiments are warranted to  
366 validate our findings.

## 367 5. Conclusion

368 The systematic analysis of the transcriptional profiles of HCM and exploration of the  
369 potential underlying molecular mechanisms led to the identification of m6A, immune  
370 and hubgene subtype of HCM. Based on these, a risk assessment model of HCM was  
371 developed that brings a novel understanding to the current understanding of HCM.

## 372 Abbreviations

373

374 .

## 375 Declarations

### 376 Ethics approval and consent to participate

377 All animal experiment was conducted in accordance with the internationally accepted  
378 principles for laboratory animal use and care and was reviewed and approved by the  
379 Experimental Animal Center of Zhengzhou University (Zhengzhou, China) (ZZU-  
380 LAC20220311[23]). Our study is reported in accordance with the Animal Research:  
381 Reporting of *in vivo* Experiments guidelines.

382 Consent for publication

383 Not applicable.

384 Availability of data and materials

385 All data generated or analyzed during this study are included in this published article

386 and its supplementary information files.

387 Competing interests

388 Not applicable.

389 Funding

390 This work was partly funded by.

391 Authors contributions

392 BL and NG conceived, designed, and planned the study. BL and NG acquired and

393 analyzed the data. BL completed the experiments. BL and NG interpreted the results.

394 BL drafted the manuscript and NG contributed to the critical revision of the

395 manuscript. All authors read and approved the final manuscript.

396 Acknowledgments

397 We are grateful to all research scientists who participated in the aforementioned

398 databases.

399 References

- 400 1. Palandri C, Santini L, Argirò A, Margara F, Doste R, Bueno-Orovio A,  
401 Olivotto I, Coppini R: **Pharmacological Management of Hypertrophic  
402 Cardiomyopathy: From Bench to Bedside.** *Drugs* 2022, **82**(8):889-912.
- 403 2. Ommen SR, Mital S, Burke MA, Day SM, Deswal A, Elliott P, Evanovich LL,  
404 Hung J, Joglar JA, Kantor P *et al*: **2020 AHA/ACC Guideline for the  
405 Diagnosis and Treatment of Patients With Hypertrophic Cardiomyopathy:  
406 A Report of the American College of Cardiology/American Heart  
407 Association Joint Committee on Clinical Practice Guidelines.** *Circulation*  
408 2020, **142**(25):e558-e631.
- 409 3. Elliott PM, Anastasakis A, Borger MA, Borggrefe M, Cecchi F, Charron P,  
410 Hagege AA, Lafont A, Limongelli G, Mahrholdt H *et al*: **2014 ESC  
411 Guidelines on diagnosis and management of hypertrophic  
412 cardiomyopathy: the Task Force for the Diagnosis and Management of  
413 Hypertrophic Cardiomyopathy of the European Society of Cardiology  
414 (ESC).** *European heart journal* 2014, **35**(39):2733-2779.
- 415 4. Covella M, Rowin EJ, Hill NS, Preston IR, Milan A, Opotowsky AR, Maron  
416 BJ, Maron MS, Maron BA: **Mechanism of Progressive Heart Failure and**

- 417           **Significance of Pulmonary Hypertension in Obstructive Hypertrophic**  
418           **Cardiomyopathy.** *Circ Heart Fail* 2017, **10**(4):e003689.
- 419    5.    Ommen SR, Semsarian C: **Hypertrophic cardiomyopathy: a practical**  
420           **approach to guideline directed management.** *Lancet (London, England)*  
421           2021, **398**(10316):2102-2108.
- 422    6.    Geisterfer-Lowrance AA, Christe M, Conner DA, Ingwall JS, Schoen FJ,  
423           Seidman CE, Seidman JG: **A mouse model of familial hypertrophic**  
424           **cardiomyopathy.** *Science (New York, NY)* 1996, **272**(5262):731-734.
- 425    7.    Pagiatakis C, Di Mauro V: **The Emerging Role of Epigenetics in**  
426           **Therapeutic Targeting of Cardiomyopathies.** *Int J Mol Sci* 2021,  
427           **22**(16):8721.
- 428    8.    Takeda Y, Demura M, Yoneda T, Takeda Y: **DNA Methylation of the**  
429           **Angiotensinogen Gene, AGT, and the Aldosterone Synthase Gene,**  
430           **CYP11B2 in Cardiovascular Diseases.** *Int J Mol Sci* 2021, **22**(9):4587.
- 431    9.    Liu C, Gu L, Deng W-J, Meng Q-C, Li N, Dai G, Yu S, Fang H: **N6-**  
432           **Methyladenosine RNA Methylation in Cardiovascular Diseases.** *Frontiers*  
433           *in cardiovascular medicine* 2022, **9**:887838.
- 434    10.   Chien C-S, Li JY-S, Chien Y, Wang M-L, Yarmishyn AA, Tsai P-H, Juan C-  
435           C, Nguyen P, Cheng H-M, Huo T-I *et al*: **METTTL3-dependent N(6)-**  
436           **methyladenosine RNA modification mediates the atherogenic**  
437           **inflammatory cascades in vascular endothelium.** *Proc Natl Acad Sci U S A*  
438           2021, **118**(7):e2025070118.
- 439    11.   Li B-C, Zhang T, Liu M-X, Cui Z, Zhang Y-H, Liu M, Liu Y, Sun Y, Li M,  
440           Tian Y *et al*: **RNA N(6)-methyladenosine modulates endothelial**  
441           **atherogenic responses to disturbed flow in mice.** *eLife* 2022, **11**:e69906.
- 442    12.   Su X, Shen Y, Jin Y, Kim I-M, Weintraub NL, Tang Y: **Aging-Associated**  
443           **Differences in Epitranscriptomic m6A Regulation in Response to Acute**  
444           **Cardiac Ischemia/Reperfusion Injury in Female Mice.** *Front Pharmacol*  
445           2021, **12**:654316.
- 446    13.   Mo X-B, Lei S-F, Zhang Y-H, Zhang H: **Examination of the associations**  
447           **between m(6)A-associated single-nucleotide polymorphisms and blood**  
448           **pressure.** *Hypertension research : official journal of the Japanese Society of*  
449           *Hypertension* 2019, **42**(10):1582-1589.
- 450    14.   Cheng P-K, Han H-K, Chen F-L, Cheng L, Ma C, Huang H, Chen C, Li H,  
451           Cai H, Huang H *et al*: **Amelioration of acute myocardial infarction injury**  
452           **through targeted ferritin nanocages loaded with an ALKBH5 inhibitor.**  
453           *Acta biomaterialia* 2022, **140**:481-491.
- 454    15.   Qian B-H, Wang P, Zhang D-H, Wu L: **m6A modification promotes miR-**  
455           **133a repression during cardiac development and hypertrophy via**  
456           **IGF2BP2.** *Cell Death Discov* 2021, **7**:157-157.
- 457    16.   Mathiyalagan P, Adamiak M, Mayourian J, Sassi Y, Liang Y, Agarwal N, Jha  
458           D, Zhang S, Kohlbrenner E, Chepurko E *et al*: **FTO-Dependent N(6)-**



- 459           **Methyladenosine Regulates Cardiac Function During Remodeling and**  
460           **Repair.** *Circulation* 2019, **139**(4):518-532.
- 461    17.    Zhang B-J, Xu Y-M, Cui X-T, Jiang H, Luo W, Weng X, Wang Y, Zhao Y,  
462           Sun A, Ge J: **Alteration of m6A RNA Methylation in Heart Failure With**  
463           **Preserved Ejection Fraction.** *Frontiers in cardiovascular medicine* 2021,  
464           **8**:647806.
- 465    18.    Shulman Z, Stern-Ginossar N: **The RNA modification N(6)-**  
466           **methyladenosine as a novel regulator of the immune system.** *Nature*  
467           *immunology* 2020, **21**(5):501-512.
- 468    19.    Wang Y-N, Yu C-Y, Jin H-Z: **RNA N(6)-Methyladenosine Modifications**  
469           **and the Immune Response.** *Journal of immunology research* 2020,  
470           **2020**:6327614.
- 471    20.    Liang C-Z, Wang S, Zhang M, Li T: **Diagnosis, clustering, and immune cell**  
472           **infiltration analysis of m6A-related genes in patients with acute**  
473           **myocardial infarction-a bioinformatics analysis.** *Journal of thoracic*  
474           *disease* 2022, **14**(5):1607-1619.
- 475    21.    Yin F-X, Zhang H, Guo P-P, Wu Y, Zhao X, Li F, Bian C, Chen C, Han Y,  
476           Liu K: **Comprehensive Analysis of Key m6A Modification Related Genes**  
477           **and Immune Infiltrates in Human Aortic Dissection.** *Frontiers in*  
478           *cardiovascular medicine* 2022, **9**:831561.
- 479    22.    Kardaszewicz B, Rogala E, Tendera M, Kardaszewicz P, Jarzab J:  
480           **Circulating immune complexes in hypertrophic cardiomyopathy and**  
481           **ischemic heart disease.** *Kardiologia polska* 1991, **34**(1):21-24.
- 482    23.    Lüscher TF: **An update on cardiomyopathies: immune-mediated diseases,**  
483           **sarcoidosis, and peripartum and hypertrophic cardiomyopathies during**  
484           **pregnancy.** *European heart journal* 2017, **38**(35):2635-2638.
- 485    24.    Wang Z-Q, Ruan H-Y, Li L-Y, Wei X, Zhu Y, Wei J, Chen X, He S:  
486           **Assessing the relationship between systemic immune-inflammation index**  
487           **and mortality in patients with hypertrophic cardiomyopathy.** *Upsala*  
488           *journal of medical sciences* 2021, **126**.
- 489    25.    Maron BA, Wang R-S, Shevtsov S, Drakos SG, Arons E, Wever-Pinzon O,  
490           Huggins GS, Samokhin AO, Oldham WM, Aguib Y *et al*: **Individualized**  
491           **interactomes for network-based precision medicine in hypertrophic**  
492           **cardiomyopathy with implications for other clinical pathophenotypes.** *Nat*  
493           *Commun* 2021, **12**(1):873-873.
- 494    26.    Zhou J-G, Liang B, Jin S-H, Liao H-L, Du G-B, Cheng L, Ma H, Gaipl US:  
495           **Development and Validation of an RNA-Seq-Based Prognostic Signature**  
496           **in Neuroblastoma.** *Front Oncol* 2019, **9**:1361.
- 497    27.    Zhou J-G, Liang B, Liu J-G, Jin S-H, He S-S, Frey B, Gu N, Fietkau R, Hecht  
498           M, Ma H *et al*: **Identification of 15 lncRNAs Signature for Predicting**  
499           **Survival Benefit of Advanced Melanoma Patients Treated with Anti-PD-1**  
500           **Monotherapy.** *Cells* 2021, **10**(5):977.

- 501 28. Kainuma A, Ning Y, Kurlansky PA, Wang AS, Latif F, Sayer GT, Uriel N,  
502 Kaku Y, Naka Y, Takeda K: **Predictors of one-year outcome after cardiac**  
503 **re-transplantation: Machine learning analysis.** *Clinical transplantation*  
504 2022:e14761.
- 505 29. Lu W-C, Chen H, Liang B, Ou C-P, Zhang M, Yue Q, Xie J: **Integrative**  
506 **Analyses and Verification of the Expression and Prognostic Significance**  
507 **for RCN1 in Glioblastoma Multiforme.** *Front Mol Biosci* 2021, **8**:736947.
- 508 30. Zhang M-W, Chen H, Liang B, Wang X-Z, Gu N, Xue F-Q, Yue Q-Y, Zhang  
509 Q-Y, Hong J-S: **Prognostic Value of mRNAsi/Corrected mRNAsi**  
510 **Calculated by the One-Class Logistic Regression Machine-Learning**  
511 **Algorithm in Glioblastoma Within Multiple Datasets.** *Front Mol Biosci*  
512 2021, **8**:777921.
- 513 31. Wilkerson MD, Hayes DN: **ConsensusClusterPlus: a class discovery tool**  
514 **with confidence assessments and item tracking.** *Bioinformatics* 2010,  
515 **26**(12):1572-1573.
- 516 32. Yu G-C, Wang L-G, Han Y, He Q-Y: **clusterProfiler: an R package for**  
517 **comparing biological themes among gene clusters.** *Omics : a journal of*  
518 *integrative biology* 2012, **16**(5):284-287.
- 519 33. Luo W-J, Brouwer C: **Pathview: an R/Bioconductor package for pathway-**  
520 **based data integration and visualization.** *Bioinformatics* 2013, **29**(14):1830-  
521 1831.
- 522 34. Liberzon A, Birger C, Thorvaldsdóttir H, Ghandi M, Mesirov JP, Tamayo P:  
523 **The Molecular Signatures Database (MSigDB) hallmark gene set**  
524 **collection.** *Cell Syst* 2015, **1**(6):417-425.
- 525 35. Subramanian A, Tamayo P, Mootha VK, Mukherjee S, Ebert BL, Gillette MA,  
526 Paulovich A, Pomeroy SL, Golub TR, Lander ES *et al*: **Gene set enrichment**  
527 **analysis: a knowledge-based approach for interpreting genome-wide**  
528 **expression profiles.** *Proc Natl Acad Sci U S A* 2005, **102**(43):15545-15550.
- 529 36. Szklarczyk D, Gable AL, Nastou KC, Lyon D, Kirsch R, Pyysalo S, Doncheva  
530 NT, Legeay M, Fang T, Bork P *et al*: **The STRING database in 2021:**  
531 **customizable protein-protein networks, and functional characterization of**  
532 **user-uploaded gene/measurement sets.** *Nucleic acids research* 2021,  
533 **49**(D1):D605-D612.
- 534 37. Chin C-H, Chen S-H, Wu H-H, Ho C-W, Ko M-T, Lin C-Y: **cytoHubba:**  
535 **identifying hub objects and sub-networks from complex interactome.**  
536 *BMC systems biology* 2014, **8 Suppl 4**(Suppl 4):S11.
- 537 38. Shannon P, Markiel A, Ozier O, Baliga NS, Wang JT, Ramage D, Amin N,  
538 Schwikowski B, Ideker T: **Cytoscape: a software environment for**  
539 **integrated models of biomolecular interaction networks.** *Genome Res* 2003,  
540 **13**(11):2498-2504.
- 541 39. Zhou G-Y, Soufan O, Ewald J, Hancock REW, Basu N, Xia J-G:  
542 **NetworkAnalyst 3.0: a visual analytics platform for comprehensive gene**

- 543 **expression profiling and meta-analysis.** *Nucleic acids research* 2019,  
544 **47(W1):W234-w241.**
- 545 40. Huang H-Y, Lin Y-C-D, Li J, Huang K-Y, Shrestha S, Hong H-C, Tang Y,  
546 Chen Y-G, Jin C-N, Yu Y *et al*: **miRTarBase 2020: updates to the**  
547 **experimentally validated microRNA-target interaction database.** *Nucleic*  
548 *acids research* 2020, **48(D1):D148-D154.**
- 549 41. Newman AM, Liu CL, Green MR, Gentles AJ, Feng W, Xu Y, Hoang CD,  
550 Diehn M, Alizadeh AA: **Robust enumeration of cell subsets from tissue**  
551 **expression profiles.** *Nat Methods* 2015, **12(5):453-457.**
- 552 42. Rockman HA, Ross RS, Harris AN, Knowlton KU, Steinhelper ME, Field LJ,  
553 Ross J, Jr., Chien KR: **Segregation of atrial-specific and inducible**  
554 **expression of an atrial natriuretic factor transgene in an in vivo murine**  
555 **model of cardiac hypertrophy.** *Proc Natl Acad Sci U S A* 1991, **88(18):8277-**  
556 **8281.**
- 557 43. Liang B, Zhang X-X, Li R, Gu N: **Guanxin V protects against ventricular**  
558 **remodeling after acute myocardial infarction through the interaction of**  
559 **TGF- $\beta$ 1 and Vimentin.** *Phytomedicine* 2022, **95:153866.**
- 560 44. Liang B, Zhang X-X, Li R, Zhu Y-C, Tian X-J, Gu N: **Guanxin V alleviates**  
561 **acute myocardial infarction by restraining oxidative stress damage,**  
562 **apoptosis, and fibrosis through the TGF- $\beta$ 1 signalling pathway.**  
563 *Phytomedicine* 2022, **100:154077.**
- 564 45. van der Velde N, Huurman R, Hassing HC, Budde RPJ, van Slegtenhorst MA,  
565 Verhagen JMA, Schinkel AFL, Michels M, Hirsch A: **Novel Morphological**  
566 **Features on CMR for the Prediction of Pathogenic Sarcomere Gene**  
567 **Variants in Subjects Without Hypertrophic Cardiomyopathy.** *Frontiers in*  
568 *cardiovascular medicine* 2021, **8:727405.**
- 569 46. Bos JM, Will ML, Gersh BJ, Kruisselbrink TM, Ommen SR, Ackerman MJ:  
570 **Characterization of a phenotype-based genetic test prediction score for**  
571 **unrelated patients with hypertrophic cardiomyopathy.** *Mayo Clinic*  
572 *proceedings* 2014, **89(6):727-737.**
- 573 47. Neubauer S, Kolm P, Ho CY, Kwong RY, Desai MY, Dolman SF,  
574 Appelbaum E, Desvigne-Nickens P, DiMarco JP, Friedrich MG *et al*: **Distinct**  
575 **Subgroups in Hypertrophic Cardiomyopathy in the NHLBI HCM**  
576 **Registry.** *Journal of the American College of Cardiology* 2019, **74(19):2333-**  
577 **2345.**
- 578 48. Zheng X-F, Liu G-Y, Huang R-N: **Identification and Verification of**  
579 **Feature Immune-Related Genes in Patients With Hypertrophic**  
580 **Cardiomyopathy Based on Bioinformatics Analyses.** *Frontiers in*  
581 *cardiovascular medicine* 2021, **8:752559.**
- 582 49. Cheng Y-M, Xie W, Pickering BF, Chu KL, Savino AM, Yang X, Luo H,  
583 Nguyen DT, Mo S, Barin E *et al*: **N(6)-Methyladenosine on mRNA**

- 584 **facilitates a phase-separated nuclear body that suppresses myeloid**  
585 **leukemic differentiation.** *Cancer cell* 2021, **39**(7):958-972.e958.
- 586 50. Roundtree IA, Luo G-Z, Zhang Z-J, Wang X, Zhou T, Cui Y, Sha J, Huang X,  
587 Guerrero L, Xie P *et al*: **YTHDC1 mediates nuclear export of N(6)-**  
588 **methyladenosine methylated mRNAs.** *eLife* 2017, **6**:e31311.
- 589 51. Ma L-F, Chen T-X, Zhang X, Miao Y, Tian X, Yu K, Xu X, Niu Y, Guo S,  
590 Zhang C *et al*: **The m(6)A reader YTHDC2 inhibits lung adenocarcinoma**  
591 **tumorigenesis by suppressing SLC7A11-dependent antioxidant function.**  
592 *Redox biology* 2021, **38**:101801.
- 593 52. Ma L-F, Zhang X, Yu K-K, Xu X, Chen T, Shi Y, Wang Y, Qiu S, Guo S, Cui  
594 J *et al*: **Targeting SLC3A2 subunit of system X(C)(-) is essential for m(6)A**  
595 **reader YTHDC2 to be an endogenous ferroptosis inducer in lung**  
596 **adenocarcinoma.** *Free radical biology & medicine* 2021, **168**:25-43.
- 597 53. Wu Y-S, Zhao W-W, Liu Y, Tan X, Li X, Zou Q, Xiao Z, Xu H, Wang Y,  
598 Yang X: **Function of HNRNPC in breast cancer cells by controlling the**  
599 **dsRNA-induced interferon response.** *The EMBO journal* 2018,  
600 **37**(23):e99017.
- 601 54. Cui Y-B, Zhang C-Y, Ma S-S, Li Z, Wang W, Li Y, Ma Y, Fang J, Wang Y,  
602 Cao W *et al*: **RNA m6A demethylase FTO-mediated epigenetic up-**  
603 **regulation of LINC00022 promotes tumorigenesis in esophageal**  
604 **squamous cell carcinoma.** *Journal of experimental & clinical cancer*  
605 *research : CR* 2021, **40**(1):294.
- 606 55. Tao L, Mu X-Y, Chen H-G, Jin D, Zhang R, Zhao Y, Fan J, Cao M, Zhou Z:  
607 **FTO modifies the m6A level of MALAT and promotes bladder cancer**  
608 **progression.** *Clinical and translational medicine* 2021, **11**(2):e310.
- 609 56. Chen Y-H, Peng C-H, Chen J-R, Chen D, Yang B, He B, Hu W, Zhang Y, Liu  
610 H, Dai L *et al*: **WTAP facilitates progression of hepatocellular carcinoma**  
611 **via m6A-HuR-dependent epigenetic silencing of ETS1.** *Molecular cancer*  
612 2019, **18**(1):127.
- 613 57. Liu X, He H-J, Zhang F-W, Hu X, Bi F, Li K, Yu H, Zhao Y, Teng X, Li J *et*  
614 *al*: **m6A methylated EphA2 and VEGFA through IGF2BP2/3 regulation**  
615 **promotes vasculogenic mimicry in colorectal cancer via PI3K/AKT and**  
616 **ERK1/2 signaling.** *Cell death & disease* 2022, **13**(5):483.
- 617 58. Hao C-C, Xu C-Y, Zhao X-Y, Luo J-N, Wang G, Zhao L-H, Ge X, Ge X-F:  
618 **Up-regulation of VANGL1 by IGF2BPs and miR-29b-3p attenuates the**  
619 **detrimental effect of irradiation on lung adenocarcinoma.** *Journal of*  
620 *experimental & clinical cancer research : CR* 2020, **39**(1):256.
- 621 59. Chen P, Li Z, Nie J, Wang H, Yu B, Wen Z, Sun Y, Shi X, Jin L, Wang D-W:  
622 **MYH7B variants cause hypertrophic cardiomyopathy by activating the**  
623 **CaMK-signaling pathway.** *Science China Life sciences* 2020, **63**(9):1347-  
624 1362.

- 625 60. Helms AS, Alvarado FJ, Yob J, Tang VT, Pagani F, Russell MW, Valdivia  
626 HH, Day SM: **Genotype-Dependent and -Independent Calcium Signaling**  
627 **Dysregulation in Human Hypertrophic Cardiomyopathy**. *Circulation* 2016,  
628 **134**(22):1738-1748.
- 629 61. Dimitrow PP, Undas A, Wołkow P, Tracz W, Dubiel JS: **Enhanced oxidative**  
630 **stress in hypertrophic cardiomyopathy**. *Pharmacological reports : PR* 2009,  
631 **61**(3):491-495.
- 632 62. Hassoun R, Budde H, Zhazykbayeva S, Herwig M, Sieme M, Delalat S,  
633 Mostafi N, Gömöri K, Tangos M, Jarkas M *et al*: **Stress activated signalling**  
634 **impaired protein quality control pathways in human hypertrophic**  
635 **cardiomyopathy**. *International journal of cardiology* 2021, **344**:160-169.

## 636 Tables

637 Table 1. Details of datasets.

638

## 639 Figure legends

640 Figure 1. Flow chart of this study.

641 Figure 2. The landscape of m6A-related regulators in HCM. A. The chromosomal  
642 locations of 20 m6A-related regulators. B. Heatmap of expression of 20 m6A-related  
643 regulators. C. Histogram of expression of 20 m6A-related regulators. \* $P < 0.05$ , \*\* $P$   
644  $< 0.01$ , \*\*\* $P < 0.001$ . D. The correlation between writers and erasers.

645 Figure 3. Random forest model construction. A. Model was built in the training cohort.  
646 B. Importance of m6A-related regulators based on the model. C. Residual plot  
647 showing the distribution of residuals in the training cohort. D. Residual plot showing  
648 the distribution of residuals in the validation cohort. E. The ROC curves showing the  
649 accuracy of the model in the training and validation cohorts.

650 Figure 4. Construction of the nomogram. A. Construction of the nomogram based on  
651 top 5 important m6A-related regulators in HCM. B. Calibration curve. C. decision  
652 curve analysis. D. ROC curve.

653 Figure 4-1. Correlation between top 5 candidate m6A regulators and immune-related  
654 cell types.

655 Figure 5. m6A subtype construction based on the expression of top 5 m6A-related  
656 regulators. A. Matrix heatmap for  $k = 2$ . B. Matrix heatmap for  $k = 3$ . C. Matrix  
657 heatmap for  $k = 4$ . D. Consistent cumulative distribution function plot. This figure  
658 allows a user to determine at what number of clusters,  $k$ , the cumulative distribution  
659 function reaches an approximate maximum, thus consensus and cluster con dence is at  
660 a maximum at this  $k$ . E. Delta area plot. The delta area score (y-axis) indicates the  
661 relative increase in cluster stability. F. Tracking plot. This plot provides a view of  
662 item cluster membership across different  $k$  and enables a user to track the history of  
663 clusters relative to earlier clusters. G. Heatmap for differentially expressed genes. H.  
664 Volcano plot for differentially expressed genes. I. Difference analysis of top 10  
665 hubgene in m6A subtype classification.

666 Figure 6. Functional enrichment of 329 differentially expressed genes. A. Top 10  
667 gene ontology terms. B. Top 7 Kyoto Encyclopedia of Genes and Genomes terms. C.  
668 Visualization of Calcium signaling pathway. D. Visualization of Leukocyte  
669 transendothelial migration. E. Gene set enrichment analysis terms.

670 Figure 7. Protein-protein interaction network. A. Protein-protein interaction network  
671 among those genes with a score greater than 0.6. B. Protein-protein interaction  
672 network of top 20 hubgenes. C. Protein-protein interaction network of top 10  
673 hubgenes.

674 Figure 8. Networks of the top 10 hubgenes. A. Hubgene-chemical network. B.  
675 Hubgene-microRNA network. C. Hubgene-transcription factor network.

676 Figure 9. Immune subtype construction. A. Matrix heatmap for  $k = 2$ . B. Matrix  
677 heatmap for  $k = 3$ . C. Consistent cumulative distribution function plot. This figure  
678 allows a user to determine at what number of clusters,  $k$ , the cumulative distribution  
679 function reaches an approximate maximum, thus consensus and cluster con dence is at  
680 a maximum at this  $k$ . D. Delta area plot. The delta area score (y-axis) indicates the  
681 relative increase in cluster stability. E. Heatmap for differentially expressed genes. F.

682 The correlation between top 10 hubgenes and immune-related cell types. G.  
683 Histogram of expression of top 10 hubgenes.  $**P < 0.01$ ,  $***P < 0.001$ .

684 Figure 10. CIBERSORT immune cell infiltration analysis and correlation analysis  
685 between hubgene and immune cells. A. Barplot showing the proportions of 22  
686 immune cells in a sepsis sample. The column in the figure is a sample. B. Correlation  
687 heat map of 22 immune cells infiltration. Blue indicated positive correlation, red  
688 indicated negative correlation, the darker the color, the stronger the correlation. C.  
689 The correlation between NFKB1 and CD8<sup>+</sup> T cells. D. The correlation between  
690 NFKB1 and T regulatory cells. E. The correlation between PSMA4 and B naïve cells.  
691 F. The correlation between PSMA4 and CD8<sup>+</sup> T cells. G. The correlation between  
692 PSMA6 and mast cells. H. The correlation between PSMA6 and T regulatory cells. I.  
693 The correlation between PSMC4 and T follicular helper cells. J. The correlation  
694 between PSMC4 and T gamma delta cells. K. The correlation between PSMD7 and T  
695 gamma delta cells. L. The correlation between PSMD8 and T gamma delta cells. M.  
696 The correlation between PSMD10 and T regulatory cells.

697 Figure 11. Hubgene subtype construction. A. Matrix heatmap for  $k = 2$ . B. Matrix  
698 heatmap for  $k = 3$ . C. Consistent cumulative distribution function plot. This figure  
699 allows a user to determine at what number of clusters,  $k$ , the cumulative distribution  
700 function reaches an approximate maximum, thus consensus and cluster con dence is at  
701 a maximum at this  $k$ . D. Delta area plot. The delta area score (y-axis) indicates the  
702 relative increase in cluster stability. E. Tracking plot. This plot provides a view of  
703 item cluster membership across different  $k$  and enables a user to track the history of  
704 clusters relative to earlier clusters. F. Principal component analysis. G. Difference  
705 analysis of top 10 hubgenes in hubgene subtype classification.

706

707 Additional files

708 Table S1. Primer sequences.

709 Figure S1. Datasets collation. A. All samples were pooled before removing batch  
710 effects. B. All samples were pooled after removing batch effects.



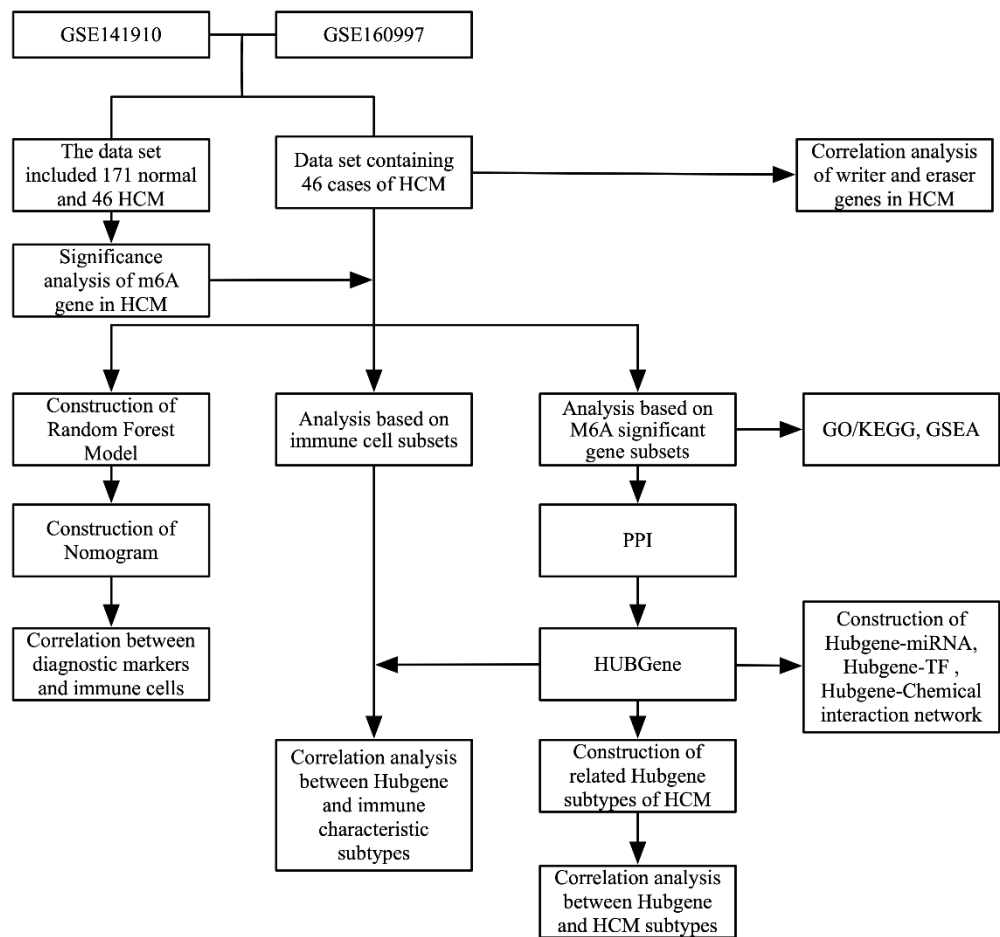

A

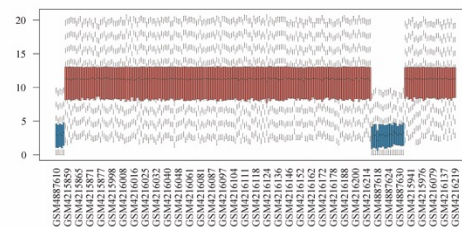

B

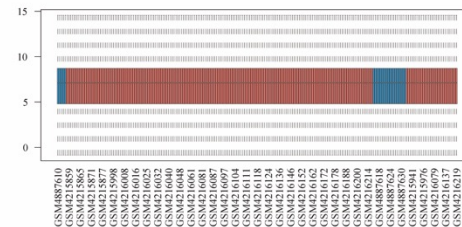



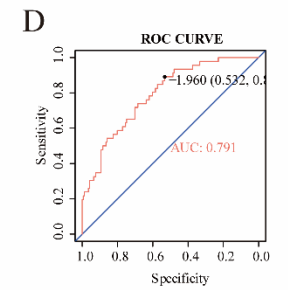
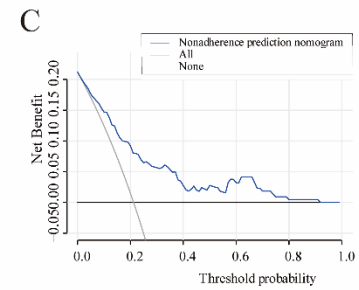
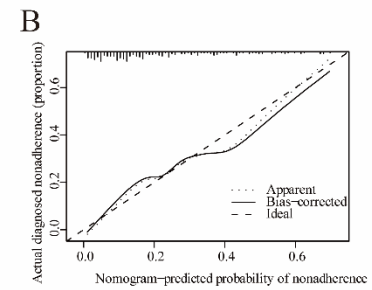
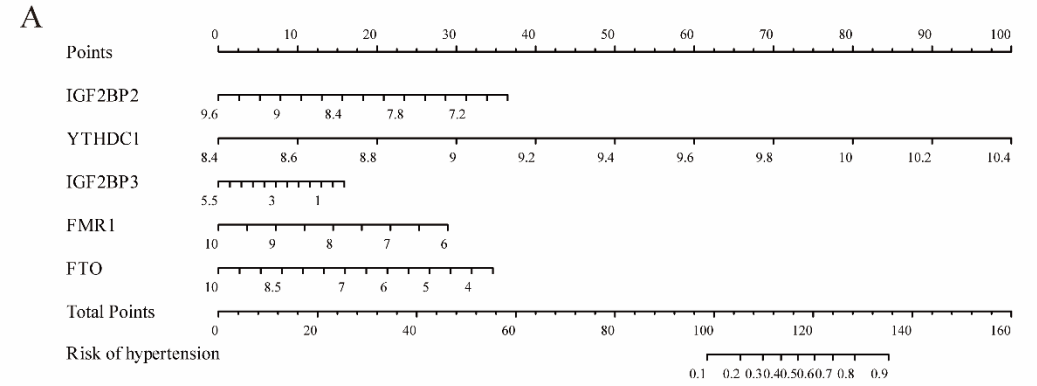
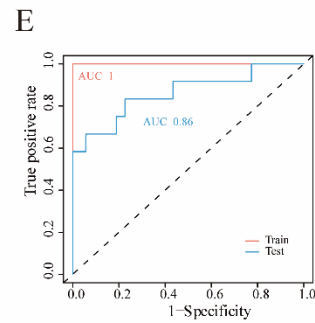
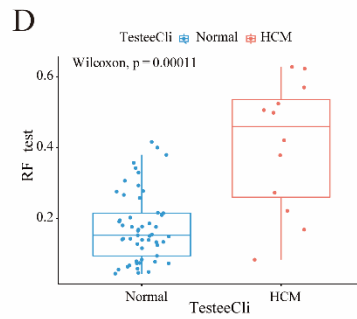
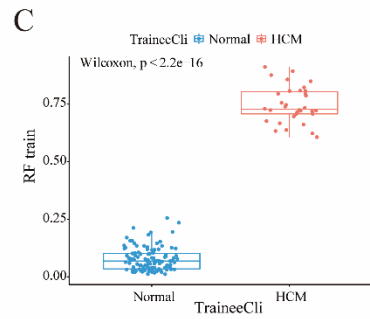
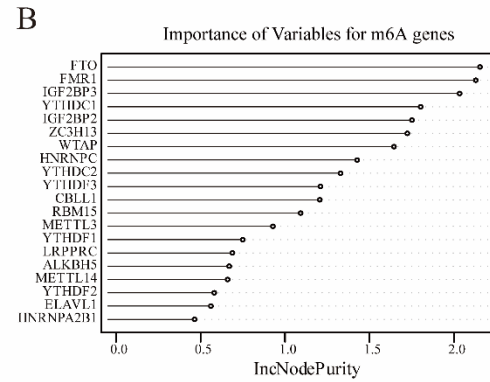
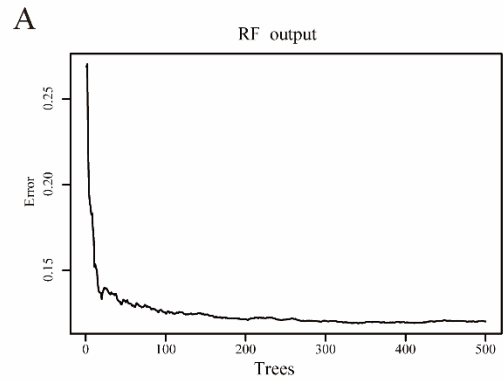

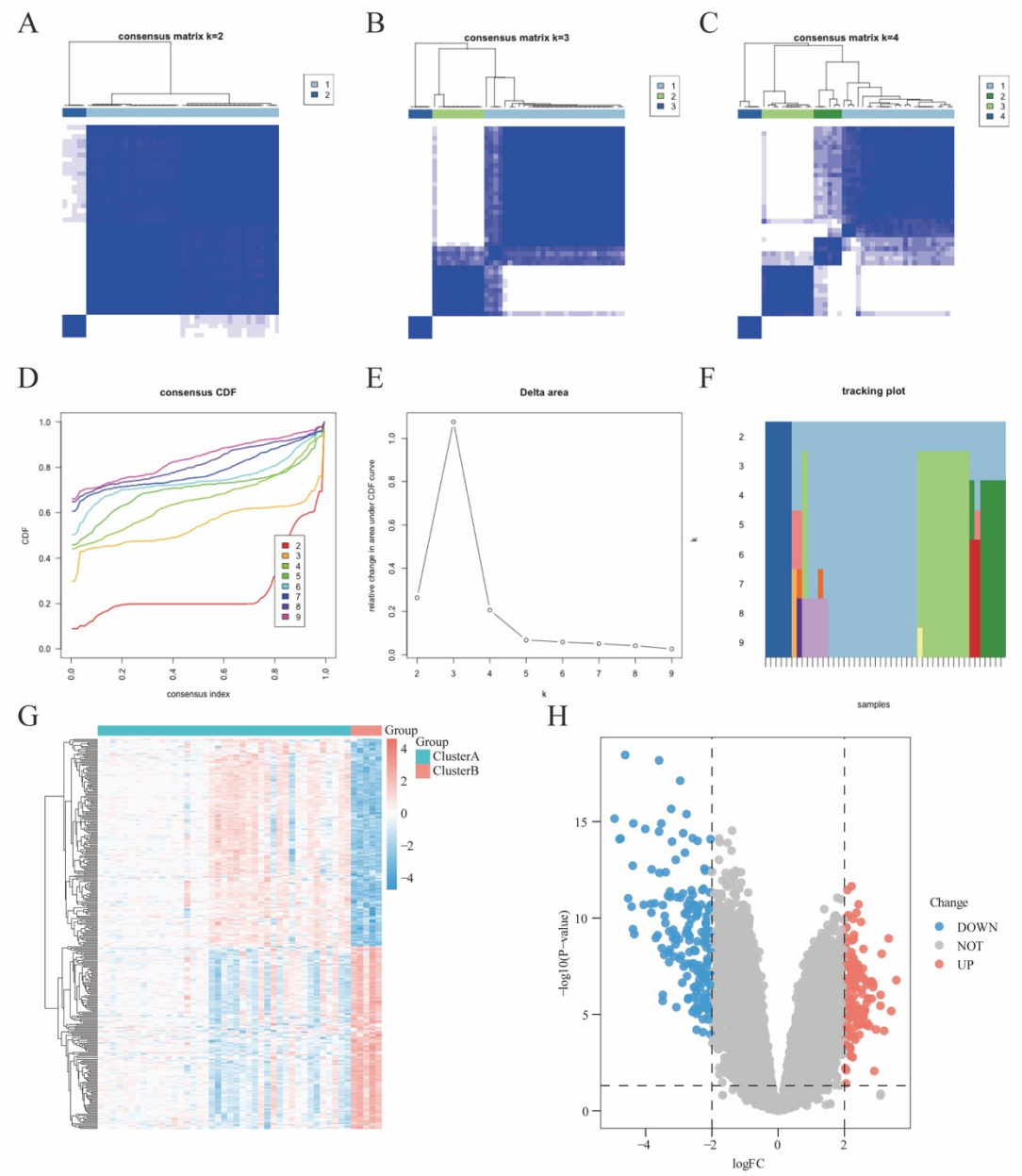
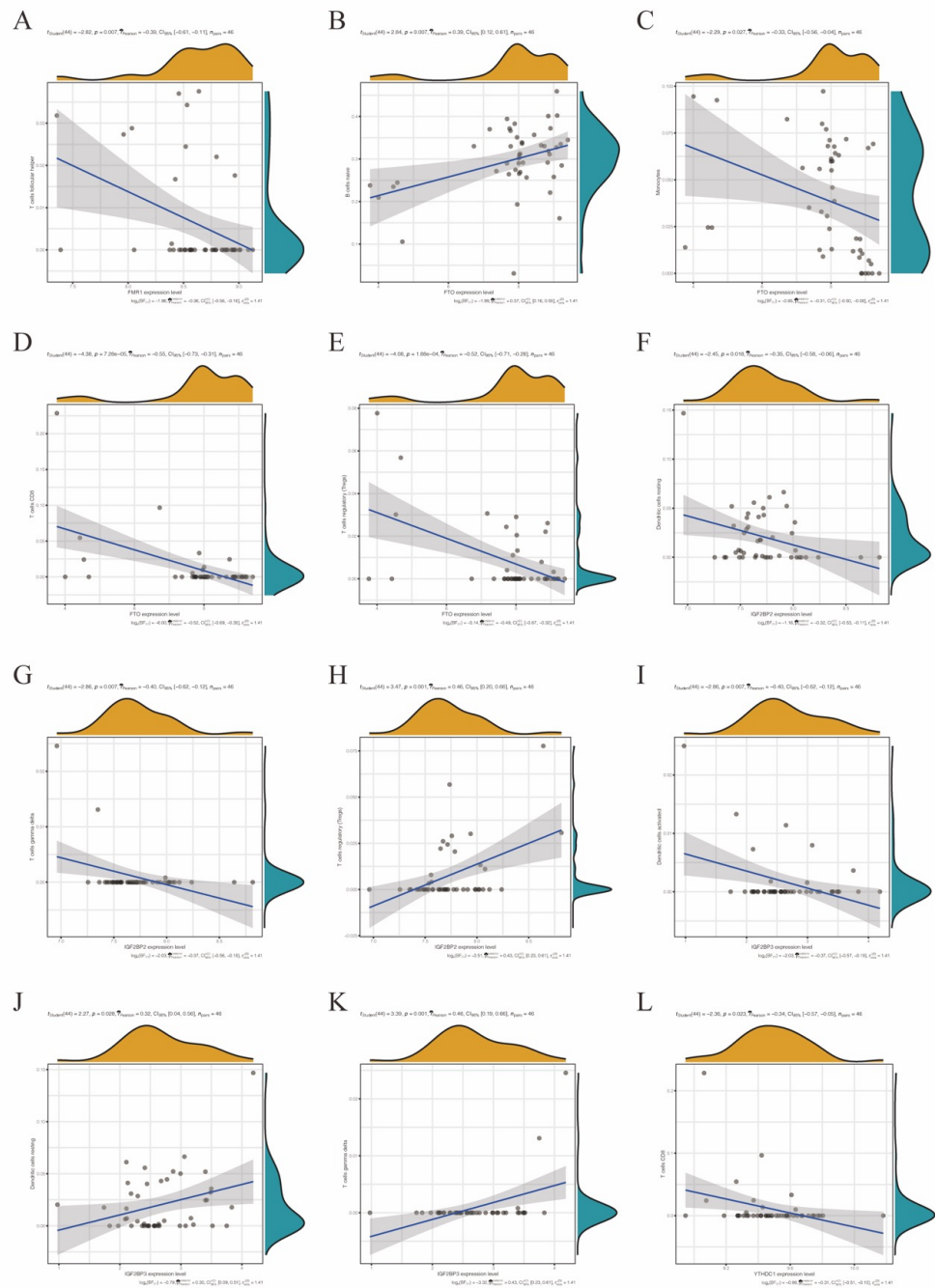

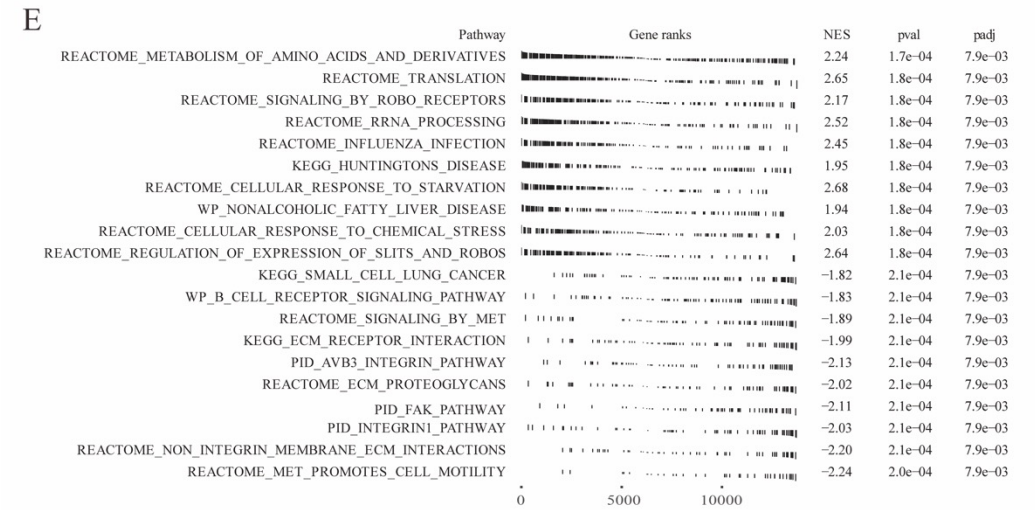
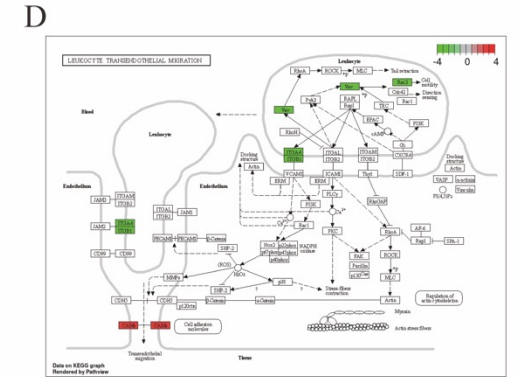
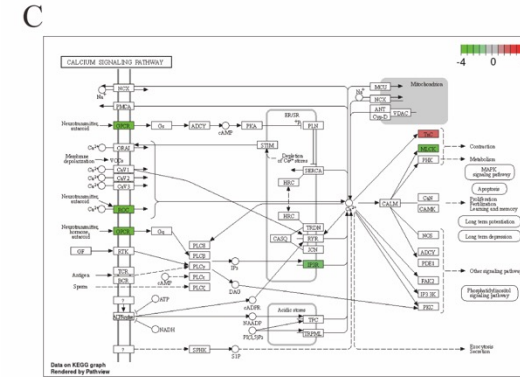
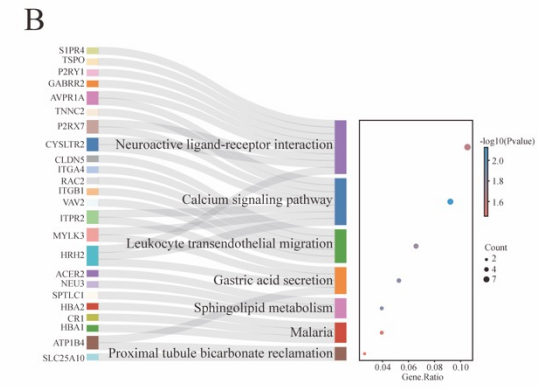
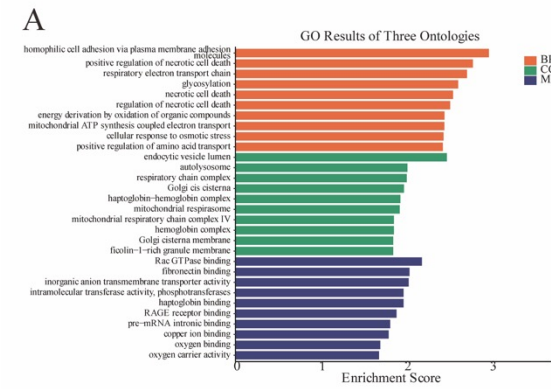
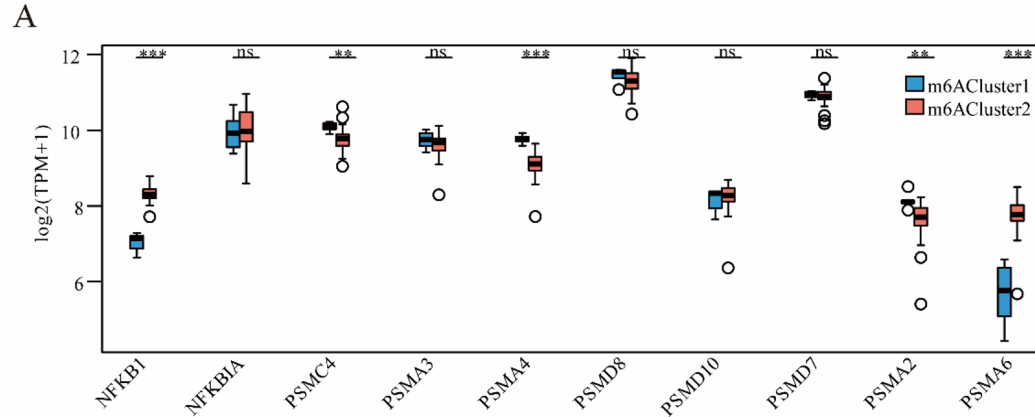

A

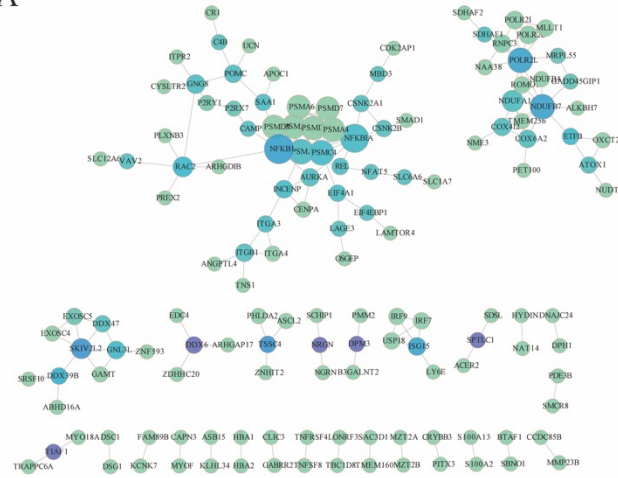

B

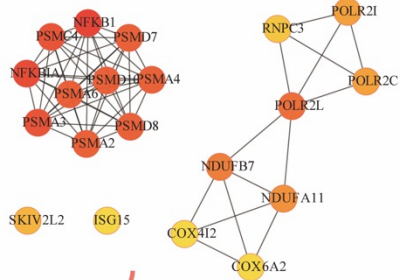

C

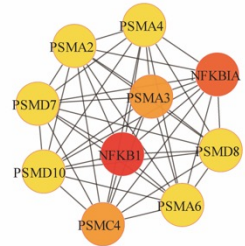

A

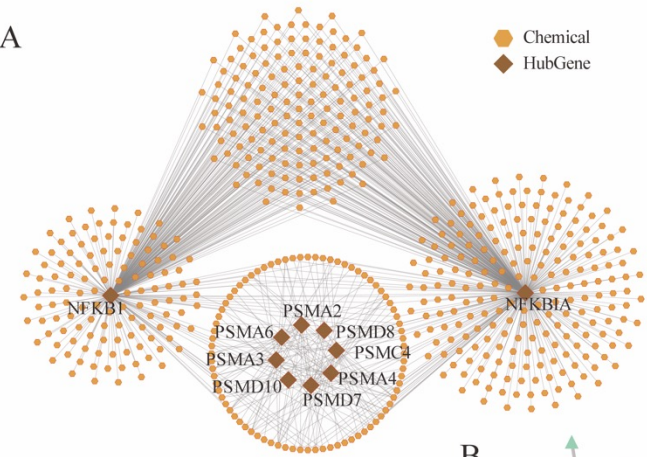

B

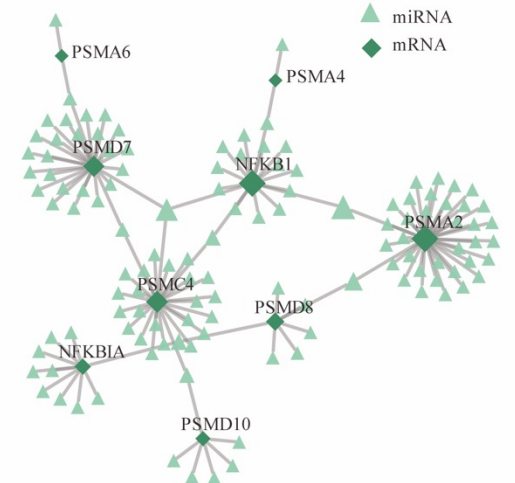

C

