

# Coupled stack-up volume RF coils for low-field open MR imaging

Yunkun Zhao<sup>1</sup>, Aditya A Bhosale<sup>1</sup>, Xiaoliang Zhang<sup>1,2\*</sup>

<sup>1</sup>Department of Biomedical Engineering, State University of New York at Buffalo, Buffalo, NY,  
United States

<sup>2</sup>Department of Electrical Engineering, State University of New York at Buffalo, Buffalo, NY,  
United States

\*Corresponding author:

Xiaoliang Zhang, Ph.D.

Department of Biomedical Engineering

State University of New York at Buffalo

Bonner Hall 215E

Buffalo, NY, 14226

U.S.A.

Email: [xzhang89@buffalo.edu](mailto:xzhang89@buffalo.edu)

**Word Count:** 3,542

**Number of figures and tables:** 10 figures and 1 table

## 22 **Abstract**

23 **Background:** Low-field open magnetic resonance imaging (MRI) systems, typically operating at  
24 magnetic field strengths below 1 Tesla, has greatly expanded the accessibility of MRI technology  
25 to meet a wide range of patient needs. However, the inherent challenges of low-field MRI, such  
26 as limited signal-to-noise ratios and limited availability of dedicated radiofrequency (RF) coils,  
27 have prompted the need for innovative coil designs that can improve imaging quality and  
28 diagnostic capabilities.

29 **Purpose:** In response to these challenges, we introduce the coupled stack-up volume coil, a  
30 novel RF coil design that addresses the shortcomings of conventional birdcage in the context of  
31 low-field open MRI.

32 **Methods:** The proposed coupled stack-up volume coil design utilizes a unique architecture that  
33 optimizes both transmit/receive efficiency and RF field homogeneity and offers the advantage of  
34 a simple design and construction, making it a practical and feasible solution for low-field MRI  
35 applications. This paper presents a comprehensive exploration of the theoretical framework,  
36 design considerations, and experimental validation of this innovative coil design.

37 **Results:** We demonstrate the superior performance of the coupled stack-up volume coil in  
38 achieving 47.7% higher transmit/receive efficiency and 68% more uniform magnetic field  
39 distribution compared to traditional birdcage coils in electromagnetic simulations. Bench tests  
40 results show that the B1 field efficiency of coupled stack-up volume coil is 57.3% higher  
41 compared with that of conventional birdcage coil.

42 **Conclusions:** The proposed coupled stack-up volume coil outperforms the conventional birdcage  
43 coil in terms of B1 efficiency, imaging coverage, and low-frequency operation capability. This  
44 design provides a robust and simple solution to low-field MR RF coil design.

45

46 **Keywords**

47 RF Coil, volume coil, low-field, stack-up coil, multimodal RF coil, head MR imaging

## 48 **1. Introduction**

49 Magnetic resonance imaging (MRI) (1,2) has evolved into an indispensable tool for clinical  
50 diagnosis and basic biomedical research (3-5), offering non-invasive and high-resolution  
51 visualization of anatomical structures (6-9), physiological processes (10-12), and functional (13-  
52 15) and metabolic (16-19) information within the human body. While high-field MRI (20-22) has  
53 demonstrated a significant SNR gain (23-25) and dominated the field (26-28), low-field MRI  
54 (below 1 Tesla) (29-32) has garnered significant attention in recent years due to its unique  
55 advantages and clinical utility (33,34), as well as recent advances in artificial intelligence (35-38).  
56 The appeal of low-field open MRI lies in its capacity to cater to a diverse patient population,  
57 including those with claustrophobia, obesity, and pediatric patients, who may find conventional  
58 closed-bore MRI systems challenging or uncomfortable (39).

59 Low-field MRI systems, characterized by magnetic field strengths below 1 Tesla, have gained  
60 significant attention due to their affordability, improved safety profile, and increased accessibility  
61 (40). However, the shift to lower magnetic field strengths introduces challenges, particularly the  
62 inherently lower signal-to-noise ratio (SNR) (41,42). This reduction in SNR can compromise  
63 image resolution and hinder the detection of subtle anatomical or pathological details,  
64 underscoring the need for innovative solutions to maintain high imaging quality in low-field MRI.

65 Open MRI systems are generally low-field systems, offering a spacious, open architecture that  
66 enhances patient comfort and accessibility. These systems are especially beneficial for certain  
67 patient populations, including those with claustrophobia, obesity, or pediatric patients, who may  
68 find conventional closed-bore MRI systems challenging. Additionally, the open design facilitates  
69 a broader range of imaging scenarios, such as interventional procedures and imaging of larger  
70 anatomical regions, making them a versatile tool in clinical practice. However, while these benefits

71 are significant, they also introduce specific challenges that must be addressed, particularly in the  
72 context of maintaining image quality at lower field strengths.

73

74 Central to the success of any MRI system is the radiofrequency (RF) coil (43-45), a crucial  
75 component responsible for transmitting and receiving MR signals during the imaging process. The  
76 design and performance of the RF coil play a pivotal role in image quality, signal strength, noise  
77 level, and overall diagnostic accuracy (46-49). In the context of low-field open MRI, the current  
78 RF coil configurations face the challenge of limited RF field (B<sub>1</sub> field) transmit/receive efficiency  
79 and field homogeneity, particularly along coil axis. To bridge this gap and harness the full potential  
80 of low-field open MRI systems, we introduce a coupled stack-up volume coil, a novel RF coil  
81 design specifically tailored for head imaging at a Larmor frequency of 21.3 MHz to address these  
82 challenges. Previous designs of stack-up coils have primarily focused on achieving decoupling  
83 between the individual coils to minimize interference and optimize performance. In contrast, our  
84 design intentionally allows the coils to be strongly coupled with each other, which enhances the  
85 overall B<sub>1</sub> field efficiency and homogeneity within the imaging volume. To investigate and  
86 demonstrate the proposed design, we have taken the 0.5T as an example field strength and designed  
87 and constructed a prototype coupled stack-up volume coil operating in the 20 MHz range. This  
88 RF coil design can significantly improve RF field efficiency and also enhance the field  
89 homogeneity along the coil axis (i.e. imaging coverage), ultimately elevating the performance of  
90 low-field open MRI systems. The proposed design of the coupled stack-up coil was analyzed using  
91 full-wave electromagnetic (EM) simulation and tested on the workbench with standard RF  
92 measurement procedures. The performance is further validated through a comparison study with a  
93 standard birdcage coil (46,50).

94

## 95 **2. Methods**

### 96 **2.1 EM Simulation**

97 Finite difference time-domain simulation software CST Studio Suite (Dassault Systèmes, Paris,  
98 France) was used to obtain numerical results of the proposed designs. Figure 1A shows the layout  
99 of the coupled stack-up volume coil. The coupled stack-up volume coil design consists of a stack  
100 of seven identical and individual coils, meticulously arranged to create a cylindrical imaging area  
101 with dimensions of 300 mm in diameter and 300 mm in length. Each coil unit is equipped with a  
102 60 pF capacitance capacitor, carefully selected to optimize its resonance characteristics at the  
103 desired Larmor frequency of 21 MHz. The coil is driven via the central coil element in this stack  
104 configuration, which provides efficient RF signal transmission and reception throughout the  
105 imaging volume. The spacing between these individual coils was carefully arranged based on the  
106 observation that in uniformly spaced coil arrays, the magnetic field strength tends to be weaker at  
107 the sides of the coil compared to the center. To address this, we adjusted the gaps so that they are  
108 smaller at the sides and larger at the center, thereby enhancing the field strength at the coil's edges.  
109 The precise gap distances were determined through a process of trial and error, involving multiple  
110 simulations and iterative adjustments, until the optimal configuration for maximum field efficiency  
111 and homogeneity was achieved. The circuit diagram and coil spacing are shown in Figure 1B.  
112 Based on the number of coils, there are four resonant modes for the coupled stack-up coil, and the  
113 lowest resonant mode is used for imaging because it has the highest field strength efficiency. A  
114 traditional 8-leg low-pass birdcage coil and a 7-turn solenoid coil, both with the same size as the  
115 coupled stack-up coil, have also been built for comparison. In a comparison study, a cylindrical

116 oil phantom ( $\sigma$ (conductivity) = 0 S/m  $\epsilon_r$ (relative permittivity) = 2.33, diameter = 20 cm,  
117 length = 30 cm) was placed centrally along the axis of the coils, with the entire volume of the  
118 phantom considered as the region of interest (ROI) for field strength and distribution evaluation.  
119 Scattering parameters and B1 field efficiency map were used to evaluate the performance of the  
120 stacked coils in coupling and imaging. To determine the performance of the proposed design under  
121 more realistic conditions, the coupled stack-up volume coil and birdcage coil were simulated on  
122 the human model Gustav for head imaging. Material properties of the human model at 21 MHz  
123 were taken from CST Studio Suite. All magnetic and electric field plots were normalized to 1 W  
124 accepted power, meaning that the field strength values were divided by the square root of the  
125 accepted power to ensure consistent comparison across different scenarios.

## 126 **2.2 Bench Test Model Assembly**

127 Figure 2A shows photographs and dimensions of bench test models of the coupled stack-up  
128 volume coil and birdcage coil. The bench test models have the same dimensions as the simulation  
129 model. The electrical track of the coupled stack-up volume coil was built using 6.35 mm-wide  
130 copper tape and mounted on a 3D-printed polylactide acid frame. Due to the width of the 3D-  
131 printed frame, the inner diameter is 260 mm and 40 mm shorter than the simulation mode. The  
132 imaging resonant frequency was tuned to 21 MHz and matched to 50 ohms by careful selection of  
133 the capacitance value on each individual coil. We used 7 identical fixed tuning capacitors with 39  
134 pF capacitance. One capacitor with 330 pF connected in parallel to the feeding line was employed  
135 for impedance matching. Except for three coils located at the center and two sides, the remaining  
136 four coils are movable, and their position may be adjusted to achieve a homogenous B-field under  
137 different imaging objects. Most areas of the coil are hollow and can also be used to alleviate  
138 claustrophobia in patients.

139 For comparison, a low-pass birdcage coil has also been made. The birdcage coil model has  
140 the same dimensions as its simulation model and the coupled stack-up volume coil. It was built  
141 using 6.35 mm-wide copper tape on a cardboard structure. The birdcage coil has 8 legs with 8  
142 tuning capacitors and was tuned to 21 MHz and matched to 50 ohms by tuning capacitors and a  
143 matching circuit.

144

### 145 **2.3 3-D Magnetic and Electric Field Mapping**

146 A sniffer positioning system combined with a magnetic and electric field measurement setup,  
147 shown in Figure 3, was used to visualize the B and E field distribution in the bench test. The system  
148 consists of a Genmitsu PROVerXL 4030 router (SainSmart, Lenexa, United States) as a  
149 positioning system, a Keysight E5061 Vector Network Analyzer (Keysight, Santa Rosa, United  
150 States) for data reception and analysis, and a B/E field sniffer to receive field strength data. The  
151 positioning system was programmed to measure the B or E field strength at a level above the coils  
152 with a data step of 0.5 mm. The design of the B and E field sniffers is also shown in Figure 3. The  
153 B field sniffer is a coaxial cable loop that can measure the magnetic flux flow through the center  
154 of the loop, and the E field sniffer is a coaxial cable with the outer conductor and medium removed  
155 at the tip. During the measurement, the coil assembly is connected to port 1 of the VNA, and the  
156 sniffer is connected to port 2. The S21 value is recorded by the VNA, and the final field strength  
157 is calculated using the following equation:

158

$$159 \quad \log(B) = \frac{1}{20} * (P_{out} - X - 20 * \log(F)) \quad (1)$$

160



161 Where  $B$  is the magnetic flux density in Tesla,  $F$  is the frequency of the received signal in  
162 megahertz,  $P_{out}$  is the probe output power into 50 ohms in dBm, and  $X$  is a scale factor from  
163 calibration. The calibration was taken place using the result from the magnetostatics method and  
164 finite-difference time-domain (FDTD) method on a 5cm diameter circular RF coil with one tuning  
165 and one matching capacitor and built with 16 AWG copper wire. Three calculation results were  
166 used, including the numerical solution and analytical solution of the Biot-Savart law:

167

$$168 \quad B(r) = a_z \frac{\mu_0 I b^2}{2(z^2 + b^2)^{3/2}} \quad (2)$$

169

170 The Biot-Savart law is used to find the magnetic flux density at a point on the axis of a circular  
171 loop of radius  $b$  that carries a direct current  $I$  to verify the magnetic field. The result from FDTD  
172 methods generated by the electromagnetic simulation model from simulation software CST Studio  
173 Suite has been used to verify electric measurement results. All three calculated and simulated  
174 results verified our measurement system is correct and accurate.

175

## 176 **3. Results**

### 177 **3.1 Simulated Resonant Frequency and Field Distribution**

178 Simulated scattering parameters versus frequency of the stacked coils are shown in Figure 4A.  
179 As shown in the figure, strong coupling is created between the coils, resulting in split resonant  
180 peaks. Four resonant frequencies were generated, with the lowest frequency at 21 MHz and the  
181 highest at 37.6 MHz. Figure 4B presents the normalized field distribution for four different  
182 resonant modes of the coupled stack-up volume coil. Among these modes, only the lowest mode

183 exhibits the strongest B1 field efficiency and a uniform field direction, making it the most suitable  
184 for MR imaging applications. The other modes show less efficient and less uniform field  
185 distributions, which are not ideal for imaging purposes. For mode 1, the unloaded Q factor is  
186 381.41 and loaded Q is 51.06. Figure 5 shows simulated Y-Z, X-Z, and X-Y plane B field  
187 efficiency maps inside phantom generated by coupled stack-up volume coils, in which both planes  
188 are at the center of the axis. A set of the multiple X-Y plane slices with different distances from  
189 the phantom center B field efficiency maps inside the phantom generated by coupled stack-up  
190 volume coil has also been shown. The simulation result shows the coupled stack-up volume coil  
191 has great field homogeneity, which can be used for MR imaging.

192

### 193 **3.2 Measured Scattering Parameters and Field Distribution**

194 Figure 6A shows that the S-parameter vs. frequency plots of the coupled stack-up coil are in  
195 good agreement with the simulation results. Four resonant modes with 20.1 MHz, 28.2 MHz, 31.8  
196 MHz, and 34.4 MHz were formed. Figure 6B shows the B field efficiency distribution map on the  
197 Y-Z plane measured with a 3-D magnetic field mapping system. Coupled stack-up volume coil  
198 shows significant homogeneity and strong B field efficiency on the Y-Z plane and is in accordance  
199 with the simulation result, which also indicates that the simulation results are accurate and reliable.

200

### 201 **3.3 Field Distribution and Efficiency Evaluation**

202 To comprehensively evaluate the performance of our proposed design, we compared three  
203 different coil setups: the coupled stack-up volume coil, the equal gap coupled coil, and a 7-turn  
204 solenoid coil. Each configuration was designed with the same dimensions to ensure a fair  
205 comparison. The coupled stack-up volume coil was designed with variable gaps between the

206 individual coils to enhance field homogeneity, while the equal gap coupled coil features evenly  
207 spaced coils along its length. The solenoid coil, commonly used in low-field MRI due to its ability  
208 to generate a uniform magnetic field along the B1 direction, was included as a benchmark.

209 Figure 7A shows the simulation models of the equal gap coupled coil and the solenoid coil. In  
210 Figure 7B, the simulated B1 field efficiency comparison is presented, while Figure 7C shows the  
211 simulated E field efficiency comparison. Figure 7D provides a 1-D profile of the field efficiency  
212 along the dashed line in Figure 7B. The results indicate that the equal-gap coupled coil and the  
213 solenoid coil exhibit relatively similar B1 field efficiencies, with both showing strong efficiency  
214 at the center of the coil. However, the coupled stack-up volume coil, while slightly lower in field  
215 efficiency at the center, demonstrates superior field homogeneity across the imaging area. This  
216 advantage in homogeneity makes the coupled stack-up volume coil more adaptable for real-world  
217 applications, where varying the layout of the coils can further optimize performance.

218 In terms of E field efficiency, which generally correlates with noise in SNR calculations, the  
219 coupled stack-up volume coil significantly outperforms the solenoid coil, exhibiting much lower  
220 E field values. This suggests that the coupled coil design could potentially generate less noise in  
221 actual imaging, leading to improved image quality and overall performance in low-field MRI  
222 systems.

223 To further validate our findings, we conducted additional simulations with a CST Studio bio-  
224 model loaded into the coils. Figure 8A presents the simulated B1 field efficiency comparison,  
225 while Figure 8B shows the simulated E field efficiency comparison. Finally, Figure 8C illustrates  
226 the simulated specific absorption rate (SAR) comparison between the different coil setups. The  
227 results from the bio-model simulations are consistent with those obtained using the oil phantom.  
228 The coupled stack-up volume coil continues to demonstrate superior field homogeneity compared

229 to the solenoid and equal gap coupled coils. In terms of E field efficiency, the coupled stack-up  
230 volume coil maintains significantly lower values, reinforcing its potential to reduce noise and  
231 enhance image quality in actual imaging scenarios.

232 Moreover, the SAR comparison in Figure 8C highlights a critical advantage of the coupled  
233 stack-up volume coil: it exhibits significantly lower SAR levels compared to the solenoid coil.  
234 This suggests that the coupled stack-up volume coil not only offers better homogeneity and lower  
235 noise but also ensures safer operation by minimizing power deposition, making it particularly  
236 suitable for prolonged imaging sessions in clinical applications.

237 Figure 9 compares the simulated B1 field efficiency between the coupled stack-up coil and  
238 birdcage coil on three different planes with the B1 field efficiency distribution map. Table 1 also  
239 compares the relative standard deviation and average B1 field efficiency of the B1 field strength  
240 inside the phantom between the field generated by the coupled stack-up coil, solenoid coil, and  
241 birdcage coil. The result shows that the coupled stack-up coil has significantly higher B1 field  
242 efficiency and B1 field homogeneity compared with the birdcage coil. With an average of 10.82  
243  $\mu\text{T}/\sqrt{W}$  throughout the entire volume of the phantom, which serves as the region of interest  
244 (ROI), the B1 field efficiency of the coupled stack-up volume coil is 47.6% higher than the average  
245 B1 field efficiency of birdcage coil. As for homogeneity, the standard deviation of B1 field  
246 generated by the coupled stack-up volume coil is also 218.75% lower than that of the birdcage  
247 coil. Figure 10 shows the comparison of the simulated B1 field efficiency between the coupled  
248 stack-up volume coil and conventional birdcage coil with human head bio model as load. At around  
249 21MHz, the B1 field distributions of both coils are not significantly affected by the load, with the  
250 B1 field distribution inside the human phantom remaining essentially consistent with that when an

251 oil phantom is used inside the coil. The B1 field efficiency of the coupled stack-up volume coil  
252 still significantly exceeds that of the birdcage coil.

253 Figure 11 compares the B1 field efficiency of the bench test model of the coupled stack-up  
254 volume coil and birdcage coil. The measured B1-field efficiency distribution is shown in Figures  
255 9A and 9B. The measured magnetic field efficiency plot is consistent with the simulation results.  
256 Figures 9C and 9D show the B1 field efficiency plot at the center line along the X-Z plane, Y-Z  
257 plane, and X-Y plane. Not only does the coupled stack-up volume coil have higher B field  
258 efficiency, but the rate of decreasing of the B1 field from the center to the sides of the birdcage  
259 coil is much higher. The B field efficiency of the coupled stack-up volume coil, with the highest  
260 field efficiency of  $11.48 \mu\text{T}/\sqrt{W}$ , only reduces by 11.4% when reaching the edge of the coil with  
261 a minimum value of  $10.20 \mu\text{T}/\sqrt{W}$ . On the other side, the B1 field efficiency of the birdcage coil  
262 decreases by 49.20% from a maximum field efficiency of  $7.30 \mu\text{T}/\sqrt{W}$  at the center to a minimum  
263 of  $3.73 \mu\text{T}/\sqrt{W}$  at two edges. The B1 field efficiency of the coupled stack-up volume coil is 57.30%  
264 higher compared with the birdcage coil. The measured result validates that the coupled stacked  
265 coil has a strong and homogeneous field within the imaging area compared with the birdcage coil.  
266

### 267 **3.5 Effect of Increasing the Number of Rings**

268 Figure 12 illustrates the impact of increasing the number of rings in the coupled stack-up volume  
269 coil on B1 field efficiency. Similar to the solenoid coil, the B1 field efficiency increases as the  
270 number of rings is increased. However, due to the width of the copper tape used to form the rings,  
271 it becomes increasingly challenging to find sufficient space to adjust the gaps between the rings.  
272 This limitation makes it more difficult to achieve a homogeneous field distribution, highlighting a  
273 trade-off between field efficiency and field homogeneity as the number of rings is increased.

## 274 **4. Discussion**

275 Critical to the success of the coupled stack-up volume coil design is the meticulous  
276 arrangement of its individual coils or resonant elements. The magnetic field strength at each  
277 coronal plane within the phantom should be most affected by the coil closest to it. By moving the  
278 coupled coil closer to the edge of the phantom where the B1 field strength is weaker, the local B1  
279 field can be improved to match the B1 field strength at the center of the coil, thus improving the  
280 overall field homogeneity.

281 In the realm of low-field open MRI systems at 0.5 Tesla, the pursuit of enhanced image quality,  
282 diagnostic accuracy, and patient comfort has led to innovative approaches and technologies. This  
283 study has introduced the coupled stack-up volume coil, a novel RF coil design engineered to  
284 address the challenges inherent in 0.5T open MRI systems, particularly with respect to  
285 transmit/reception efficiency and field homogeneity. Through a research framework encompassing  
286 electromagnetic simulations and benchtop characterizations, we have illuminated the substantial  
287 advantages offered by this innovative coil design.

288 The adjustable nature of the coupled stack-up volume RF coil design could significantly  
289 enhance the versatility and performance of low-field MRI systems. By improving B1 field  
290 efficiency and homogeneity, this coil design addresses some of the inherent challenges associated  
291 with low-field imaging, such as lower signal-to-noise ratios. Moreover, the principles of this coil  
292 could be adapted to create flexible body coils, which are increasingly important in modern MRI  
293 applications. Flexible coils can conform better to the patient's anatomy, leading to improved image  
294 quality and patient comfort. The ability to adjust the coil for different body parts would make it a  
295 versatile tool in clinical settings, particularly for imaging anatomically complex regions or for use  
296 in scenarios where patient movement is a concern. This adaptability could further extend the

297 clinical applications of low-field MRI, making it a more viable option in various diagnostic  
298 scenarios.

299 Despite the advancements introduced by the coupled stack-up volume RF coil, several  
300 challenges remain. One of the primary challenges is the need to further optimize the coil for  
301 different body parts and imaging scenarios, particularly in the context of flexible designs.  
302 Additionally, while the current design demonstrates significant improvements in field efficiency  
303 and homogeneity, there is still room for further enhancement, particularly in reducing the  
304 complexity of the design without sacrificing performance. Future design approaches might explore  
305 the integration of advanced materials or novel coil geometries to further improve the coil's  
306 adaptability and efficiency. Moreover, conducting extensive in vivo testing and developing more  
307 robust models for predicting coil performance across a range of conditions will be critical for  
308 advancing the clinical utility of these designs.

## 309 **5. Conclusion**

310 In conclusion, the coupled stack-up volume coil is successfully designed, constructed, and  
311 tested for low-field MR imaging. The proposed work represents a transformative development in  
312 the field of low-field MRI, particularly open MRI. Its innovative design, carefully arranged coil  
313 spacing, and optimized capacitance parameters converge to deliver a solution that outperforms the  
314 conventional birdcage coil in the aspects of B1 field efficiency, imaging coverage, and easy design  
315 and construction. It not only addresses the challenges posed by low-field MRI but also enhances  
316 its capabilities. The ability to achieve superior transmit/receive efficiency and field homogeneity  
317 positions this design as a promising avenue for advancing low-field MRI's diagnostic precision  
318 and clinical utility.

## 319 **Acknowledgments**

320 This work is supported in part by the NIH under a BRP grant U01 EB023829 and by the State  
321 University of New York (SUNY) under SUNY Empire Innovation Professorship Award.

322

## 323 **References**

- 324 1. Lauterbur PC. Image Formation by Induced Local Interaction: Examples employing Nuclear  
325 Magnetic Resonance. *Nature* 1973;241:190-1.
- 326 2. Garroway AN, Grannell PK, Mansfield P. Image formation in NMR by a selective irradiative  
327 process. *J Phys C: Solid State Phys* 1974;7:L457-L62.
- 328 3. Ugurbil K, Adriany G, Andersen P, Chen W, Garwood M, et al. Ultrahigh field magnetic  
329 resonance imaging and spectroscopy. *Magn Reson Imaging* 2003;21:1263-81.
- 330 4. Adriany G, Van de Moortele PF, Wiesinger F, Moeller S, Strupp JP, et al. Transmit and  
331 receive transmission line arrays for 7 Tesla parallel imaging. *Magn Reson Med* 2005;53:434-45.
- 332 5. Zhang J, Tan Q, Yin H, Zhang X, Huan Y, et al. Decreased gray matter volume in the left  
333 hippocampus and bilateral calcarine cortex in coal mine flood disaster survivors with recent  
334 onset PTSD. *Psychiatry Res* 2011;192:84-90.
- 335 6. Qi S, Mu YF, Cui LB, Zhang J, Guo F, et al. Anomalous gray matter structural networks in  
336 recent onset post-traumatic stress disorder. *Brain Imaging Behav* 2018;12:390-401.
- 337 7. Wei Z, Chen Q, Han S, Zhang S, Zhang N, et al. 5T magnetic resonance imaging: radio  
338 frequency hardware and initial brain imaging. *Quant Imaging Med Surg* 2023;13:3222-40.
- 339 8. Li Y, Chen Q, Wei Z, Zhang L, Tie C, et al. One-Stop MR Neurovascular Vessel Wall  
340 Imaging With a 48-Channel Coil System at 3 T. *IEEE Trans Biomed Eng* 2020;67:2317-27.
- 341 9. Meng Y, Mo Z, Hao J, Peng Y, Yan H, et al. High-resolution intravascular magnetic  
342 resonance imaging of the coronary artery wall at 3.0 Tesla: toward evaluation of atherosclerotic  
343 plaque vulnerability. *Quant Imaging Med Surg* 2021;11:4522-9.
- 344 10. Aranguren XL, McCue JD, Hendrickx B, Zhu XH, Du F, et al. Multipotent adult progenitor  
345 cells sustain function of ischemic limbs in mice. *J Clin Invest* 2008;118:505-14.
- 346 11. Zhu XH, Qiao H, Du F, Xiong Q, Liu X, et al. Quantitative imaging of energy expenditure in  
347 human brain. *Neuroimage* 2012;60:2107-17.
- 348 12. Liu LP, Cui LB, Zhang XX, Cao J, Chang N, et al. Diagnostic Performance of Diffusion-  
349 weighted Magnetic Resonance Imaging in Bone Malignancy: Evidence From a Meta-Analysis.  
350 *Medicine (Baltimore)* 2015;94:e1998.
- 351 13. Ogawa S, Lee TM, Kay AR, Tank DW. Brain magnetic resonance imaging with contrast  
352 dependent on blood oxygenation. *Proc Natl Acad Sci U S A* 1990;87:9868-72.
- 353 14. Zhu X, Zhang X, Tang S, Ogawa S, Ugurbil K, et al. Probing fast neuronal interaction in the  
354 human ocular dominate columns based on fMRI BOLD response at 7 Tesla. *Proceedings of the*  
355 *9th Annual Meeting of ISMRM, Glasgow, Scotland; 2001.*



- 356 15. Kwong KK, Belliveau JW, Chesler DA, Goldberg IE, Weisskoff RM, et al. Dynamic  
357 magnetic resonance imaging of human brain activity during primary sensory stimulation. Proc  
358 Natl Acad Sci U S A 1992;89:5675-9.
- 359 16. Du F, Cooper AJ, Thida T, Sehovic S, Lukas SE, et al. In vivo evidence for cerebral  
360 bioenergetic abnormalities in schizophrenia measured using <sup>31</sup>P magnetization transfer  
361 spectroscopy. JAMA Psychiatry 2014;71:19-27.
- 362 17. Kurhanewicz J, Vigneron DB, Ardenkjaer-Larsen JH, Bankson JA, Brindle K, et al.  
363 Hyperpolarized (<sup>13</sup>C) MRI: Path to Clinical Translation in Oncology. Neoplasia 2019;21:1-16.
- 364 18. Dafni H, Larson PE, Hu S, Yoshihara HA, Ward CS, et al. Hyperpolarized <sup>13</sup>C spectroscopic  
365 imaging informs on hypoxia-inducible factor-1 and myc activity downstream of platelet-derived  
366 growth factor receptor. Cancer Res 2010;70:7400-10.
- 367 19. Zhu XH, Zhang Y, Tian RX, Lei H, Zhang N, et al. Development of (<sup>17</sup>O) NMR approach  
368 for fast imaging of cerebral metabolic rate of oxygen in rat brain at high field. Proc Natl Acad  
369 Sci U S A 2002;99:13194-9.
- 370 20. Ugurbil K, Garwood M, Ellermann J, Hendrich K, Hinke R, et al. Imaging at high magnetic  
371 fields: initial experiences at 4 T. Magn Reson Q 1993;9:259-77.
- 372 21. Zhou X, Cofer GP, Suddarth SA, Johnson GA. High-field MR microscopy using fast spin-  
373 echoes. Magn Reson Med 1993;30:60-7.
- 374 22. Abduljalil AM, Kangarlu A, Zhang X, Burgess RE, Robitaille P-ML. Acquisition of Human  
375 Multislice MR Images at 8 Tesla. Journal of Computer Assisted Tomography 1999;23.
- 376 23. Hoult DI. Sensitivity and power deposition in a high-field imaging experiment. J Magn  
377 Reson Imaging 2000;12:46-67.
- 378 24. Qiao H, Zhang X, Zhu X-H, Du F, Chen W. In vivo <sup>31</sup>P MRS of human brain at  
379 high/ultrahigh fields: a quantitative comparison of NMR detection sensitivity and spectral  
380 resolution between 4 T and 7 T. Magnetic Resonance Imaging 2006;24:1281-6.
- 381 25. Ugurbil K. Magnetic resonance imaging at ultrahigh fields. IEEE Trans Biomed Eng  
382 2014;61:1364-79.
- 383 26. Ladd ME, Bachert P, Meyerspeer M, Moser E, Nagel AM, et al. Pros and cons of ultra-high-  
384 field MRI/MRS for human application. Progress in Nuclear Magnetic Resonance Spectroscopy  
385 2018;109:1-50.
- 386 27. Qi S, Mu Y, Liu K, Zhang J, Huan Y, et al. Cortical inhibition deficits in recent onset PTSD  
387 after a single prolonged trauma exposure. Neuroimage Clin 2013;3:226-33.
- 388 28. Duyn JH. The future of ultra-high field MRI and fMRI for study of the human brain.  
389 Neuroimage 2012;62:1241-8.
- 390 29. Liu Y, Leong ATL, Zhao Y, Xiao L, Mak HKF, et al. A low-cost and shielding-free ultra-  
391 low-field brain MRI scanner. Nat Commun 2021;12:7238.
- 392 30. Kladny B, Gluckert K, Swoboda B, Beyer W, Weseloh G. Comparison of low-field (0.2  
393 Tesla) and high-field (1.5 Tesla) magnetic resonance imaging of the knee joint. Arch Orthop  
394 Trauma Surg 1995;114:281-6.
- 395 31. Sepponen RE, Sipponen JT, Sivula A. Low field (0.02 T) nuclear magnetic resonance  
396 imaging of the brain. J Comput Assist Tomogr 1985;9:237-41.
- 397 32. Marques JP, Simonis FFJ, Webb AG. Low-field MRI: An MR physics perspective. J Magn  
398 Reson Imaging 2019;49:1528-42.
- 399 33. Webb A, O'Reilly T. Tackling SNR at low-field: a review of hardware approaches for point-  
400 of-care systems. MAGMA 2023;36:375-93.

- 401 34. Yuen MM, Prabhat AM, Mazurek MH, Chavva IR, Crawford A, et al. Portable, low-field  
402 magnetic resonance imaging enables highly accessible and dynamic bedside evaluation of  
403 ischemic stroke. *Sci Adv* 2022;8:eabm3952.
- 404 35. Yang Q, Zhang H, Xia J, Zhang X. Evaluation of magnetic resonance image segmentation in  
405 brain low-grade gliomas using support vector machine and convolutional neural network. *Quant*  
406 *Imaging Med Surg* 2021;11:300-16.
- 407 36. Li H, Liang Z, Zhang C, Liu R, Li J, et al. SuperDTI: Ultrafast DTI and fiber tractography  
408 with deep learning. *Magn Reson Med* 2021;86:3334-47.
- 409 37. Huang W, Yang H, Liu X, Li C, Zhang I, et al. A Coarse-to-Fine Deformable Transformation  
410 Framework for Unsupervised Multi-Contrast MR Image Registration with Dual Consistency  
411 Constraint. *IEEE Trans Med Imaging* 2021;40:2589-99.
- 412 38. Man C, Lau V, Su S, Zhao Y, Xiao L, et al. Deep learning enabled fast 3D brain MRI at  
413 0.055 tesla. *Sci Adv* 2023;9:ead19327.
- 414 39. Kimberly WT, Sorby-Adams AJ, Webb AG, Wu EX, Beekman R, et al. Brain imaging with  
415 portable low-field MRI. *Nat Rev Bioeng* 2023;1:617-30.
- 416 40. Campbell-Washburn AE, Keenan KE, Hu P, Mugler JP, 3rd, Nayak KS, et al. Low-field  
417 MRI: A report on the 2022 ISMRM workshop. *Magn Reson Med* 2023;90:1682-94.
- 418 41. Hoult DI, Richards RE. The signal-to-noise ratio of the nuclear magnetic resonance  
419 experiment. *J Magn Reson* 1976;24:71-85.
- 420 42. Li Y, Pang Y, Vigneron D, Glenn O, Xu D, et al. Investigation of multichannel phased array  
421 performance for fetal MR imaging on 1.5T clinical MR system. *Quant Imaging Med Surg*  
422 2011;1:24-30.
- 423 43. Li Y, Yu B, Pang Y, Vigneron DB, Zhang X. Planar quadrature RF transceiver design using  
424 common-mode differential-mode (CMDM) transmission line method for 7T MR imaging. *PLoS*  
425 *One* 2013;8:e80428.
- 426 44. Rutledge O, Kwak T, Cao P, Zhang X. Design and test of a double-nuclear RF coil for (1)H  
427 MRI and (13)C MRSI at 7T. *J Magn Reson* 2016;267:15-21.
- 428 45. Chen Q, Xie G, Luo C, Yang X, Zhu J, et al. A Dedicated 36-Channel Receive Array for  
429 Fetal MRI at 3T. *IEEE Trans Med Imaging* 2018;37:2290-7.
- 430 46. Wang C, Li Y, Wu B, Xu D, Nelson SJ, et al. A practical multinuclear transceiver volume  
431 coil for in vivo MRI/MRS at 7 T. *Magn Reson Imaging* 2012;30:78-84.
- 432 47. Pang Y, Xie Z, Li Y, Xu D, Vigneron D, et al. Resonant Mode Reduction in Radiofrequency  
433 Volume Coils for Ultrahigh Field Magnetic Resonance Imaging. *Materials (Basel)* 2011;4:1333-  
434 44.
- 435 48. Subburaj K, Pang Y, Scott S, Amirbekian B, Souza RB, et al. A Flexible Microstrip  
436 Transceiver Coil for Imaging Flexed Human Knee Joints at 7 Tesla. *Proc Intl Soc Mag Reson*  
437 *Med* 2011;19:3821.
- 438 49. Pang Y, Xie Z, Xu D, Kelley DA, Nelson SJ, et al. A dual-tuned quadrature volume coil with  
439 mixed  $\lambda/2$  and  $\lambda/4$  microstrip resonators for multinuclear MRSI at 7 T. *Magn Reson*  
440 *Imaging* 2012;30:290-8.
- 441 50. Hayes CE, Edelstein WA, Schenck JF, Mueller OM, Eash M. An Efficient, Highly  
442 Homogeneous Radiofrequency Coil for Whole-Body NMR Imaging at 1.5 T. *Journal of*  
443 *Magnetic Resonance* 1985;63:622-8.

444

445

## 446 Figure legends

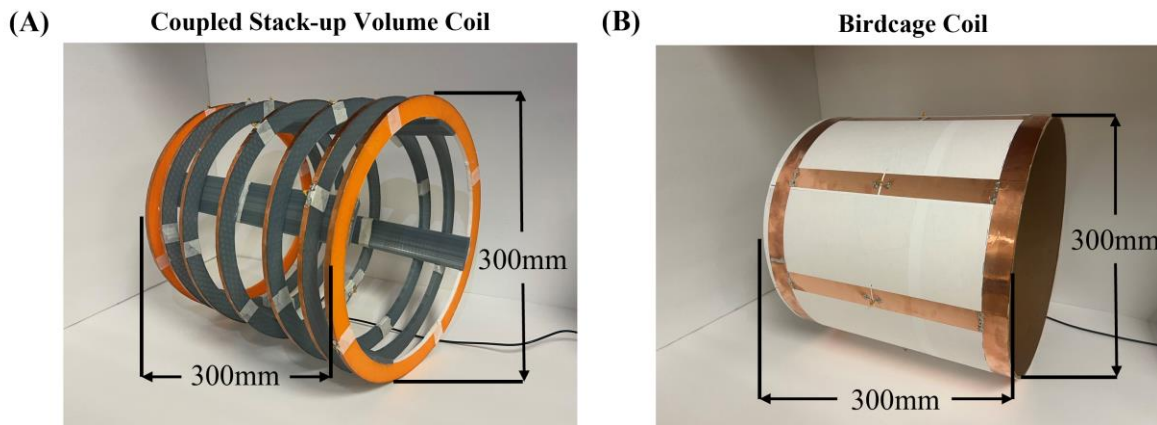

447

448 **Figure 1.** (A) Simulation model of coupled stack-up volume coil. (B) Circuit diagram of coupled

449 stack-up volume coil. The distance between individual coils has been labeled in the figure.

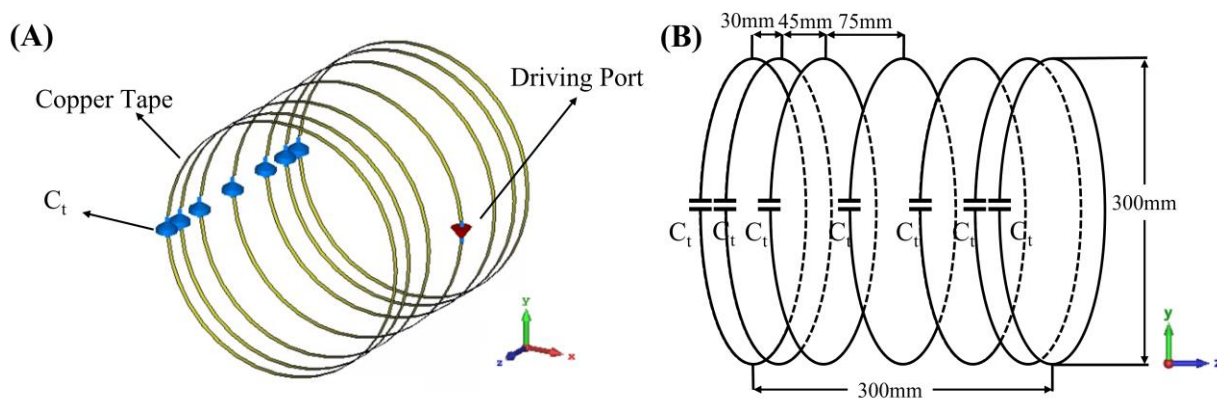

450

451 **Figure 2.** A photograph (A) of the bench test coupled stack-up volume coil model for imaging at

452 0.5T, corresponding resonant frequency of 21 MHz. For comparison, a custom-built 21 MHz low-

453 pass birdcage coil (B) was used in this paper.

(A)

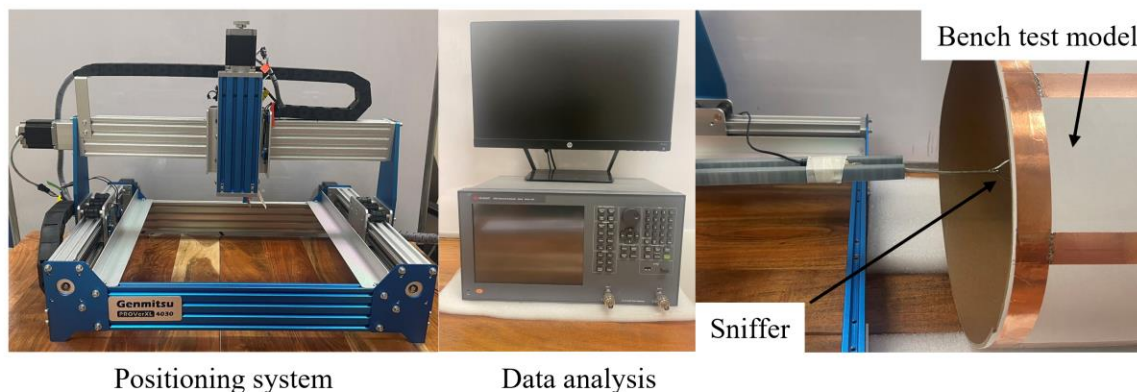

(B)

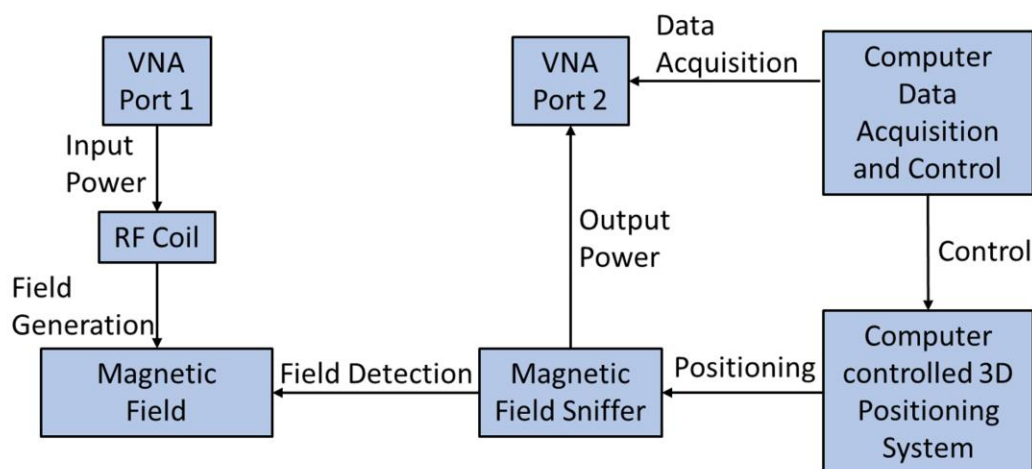

454

455 **Figure 3.** (A) Experimental setup of the sniffer-positioning system combined magnetic field  
456 measurement for the coupled stack-up volume coil. The FOV of the measuring system is 200 mm  
457 \* 150 mm \* 80 mm, and the resolution is 0.5 mm \* 0.5 mm. (B) Data processing flow for the 3-D  
458 magnetic field mapping system.

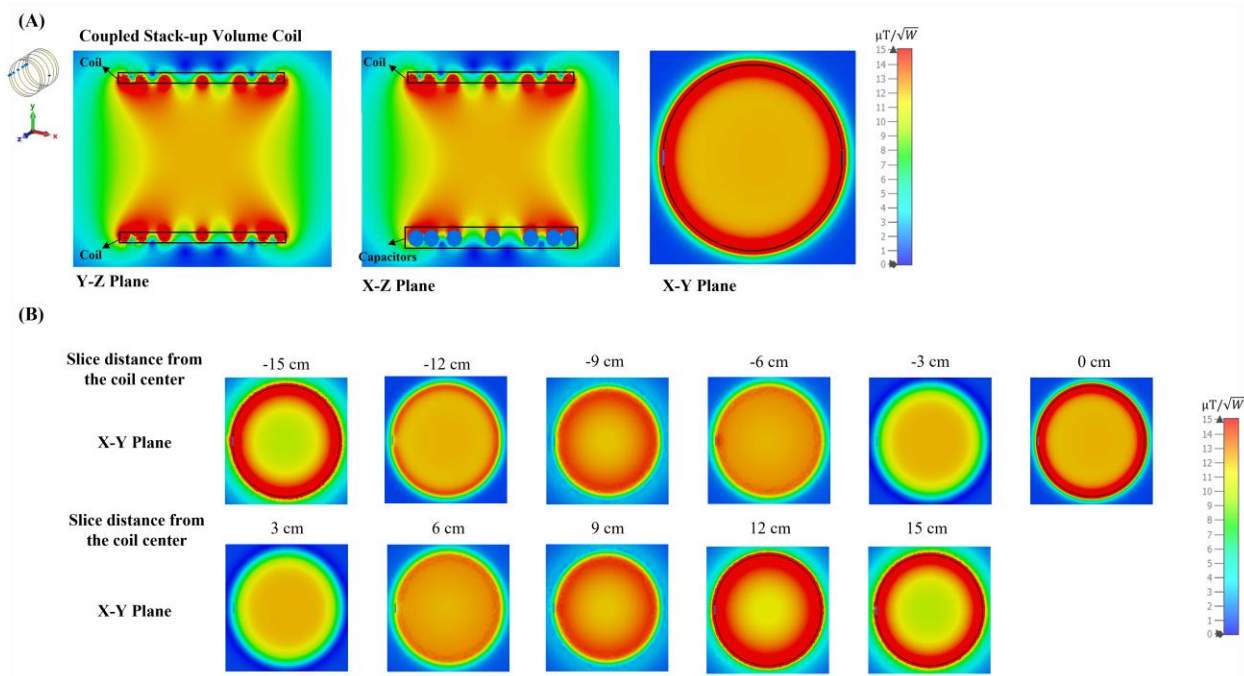

459

460 **Figure 4.** (A) Simulated S11 vs. frequency of the coupled stack-up volume coils. (B) Normalized

461 B1 field distribution for each mode.

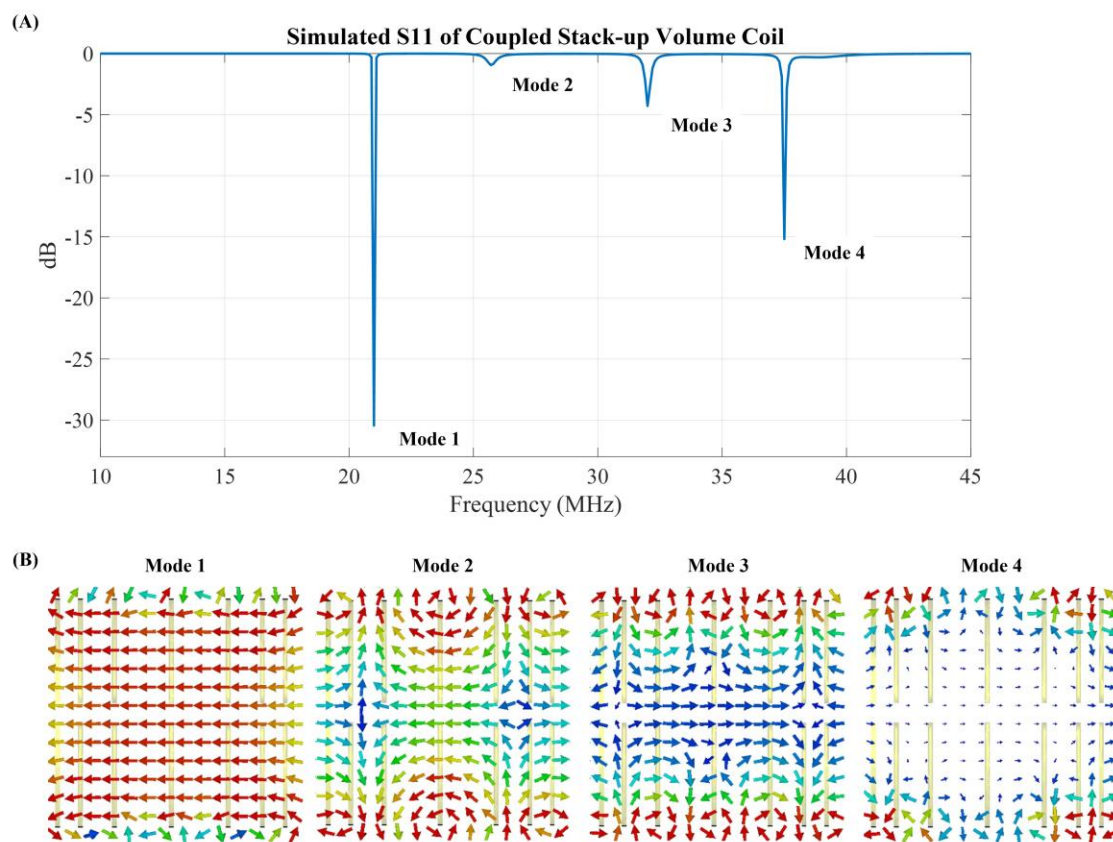

462  
463 **Figure 5.** (A) Simulated unloaded Y-Z, X-Z, and X-Y plane B field efficiency maps inside oil  
464 phantom generated by coupled stack-up volume coils. Both planes are at the center of the axis. (B)  
465 A set of the multiple X-Y plane slices with different distances from the phantom center B field  
466 efficiency maps inside the phantom generated by coupled stack-up volume coil.

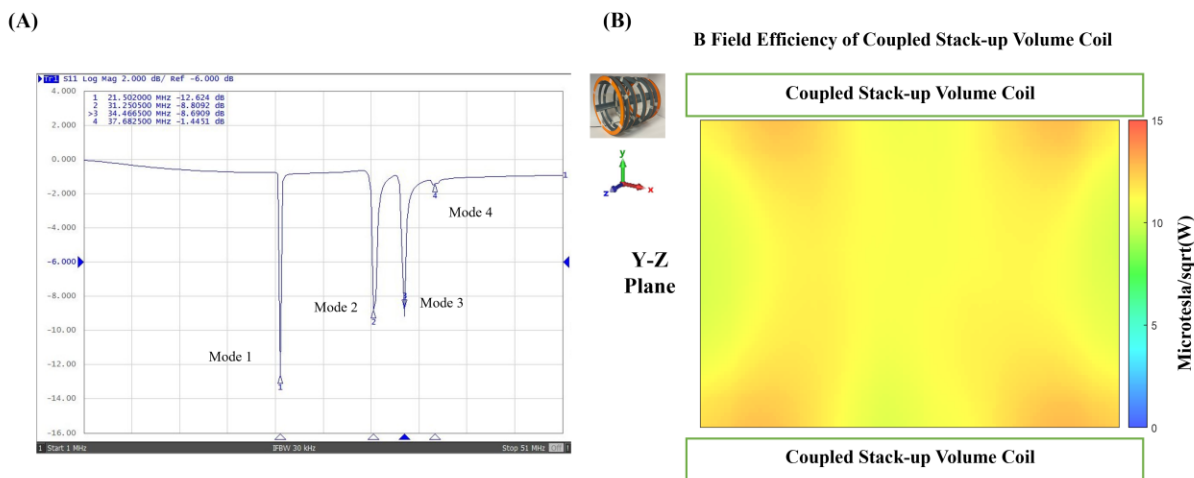

467  
 468 **Figure 6.** (A) Scattering parameters vs. frequency of the bench test model of coupled stack-up  
 469 volume coils. (B) Measured unloaded B field efficiency maps on the Y-Z plane of coupled stack-  
 470 up volume coil.

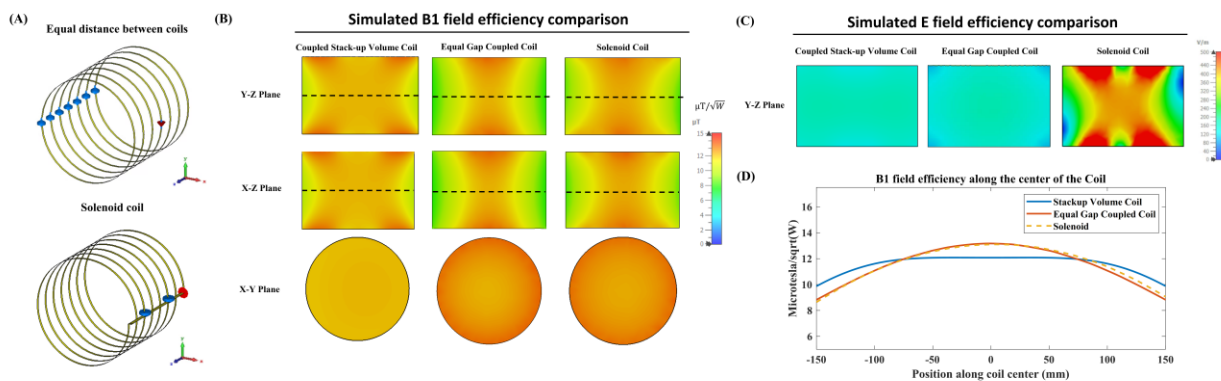

471  
 472 **Figure 7.** (A) Simulation models of the equal gap coupled coil and the 7-turn solenoid coil. (B)  
 473 Simulated unloaded B1 field efficiency comparison among the coupled stack-up volume coil, the  
 474 equal gap coupled coil, and the solenoid coil. (C) Simulated unloaded E field efficiency  
 475 comparison between the three coils. (D) 1-D profile of the field efficiency along the center line of  
 476 the coils (dashed line in Figure 7B), showing the field distribution along the coil axis.

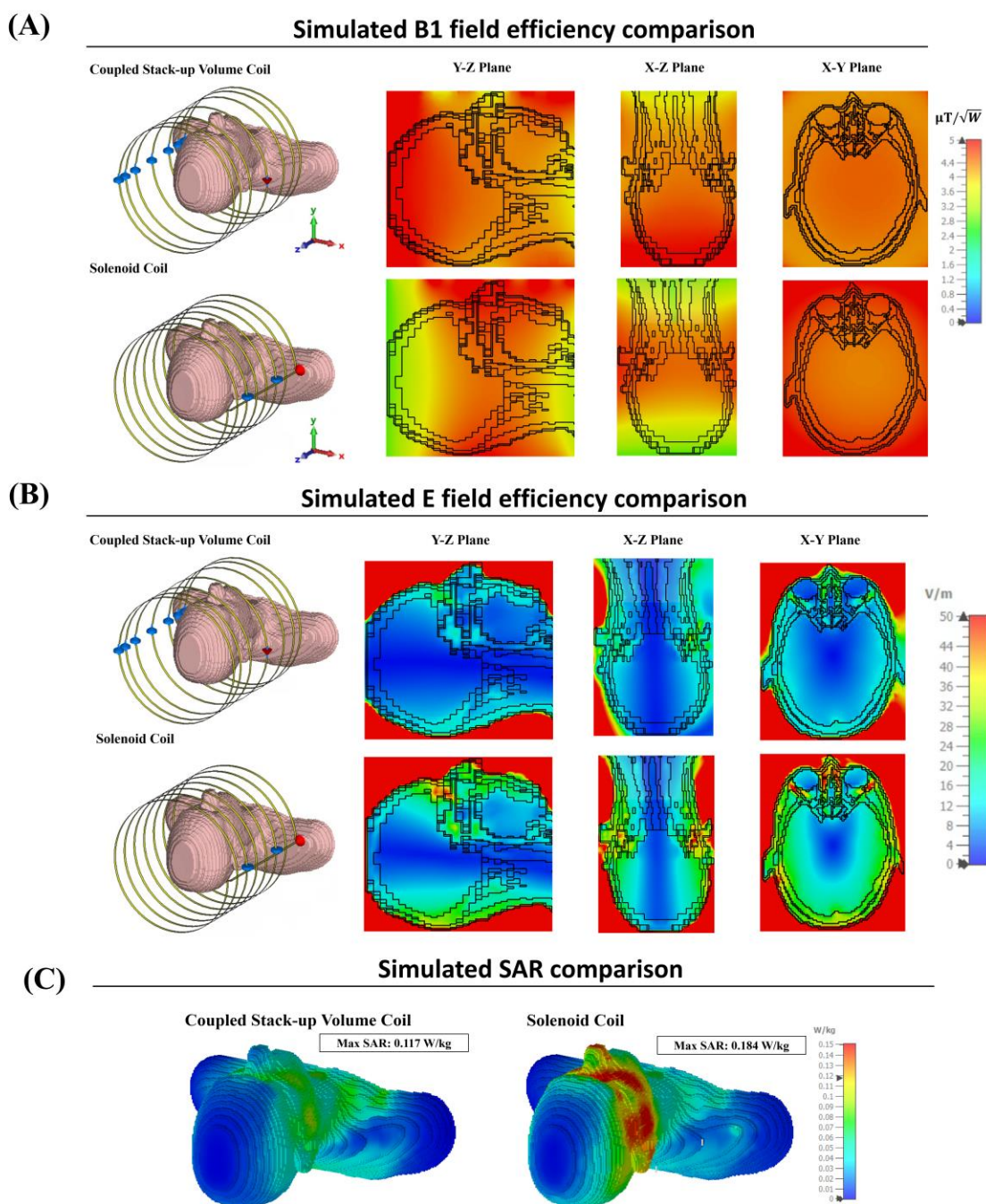

477  
478 **Figure 8.** (A) Simulated loaded B1 field efficiency comparison with a CST Studio bio-model  
479 loaded into the coils. (B) Simulated loaded E field efficiency comparison with the bio-model. (C)  
480 Simulated SAR comparison between the three coils.



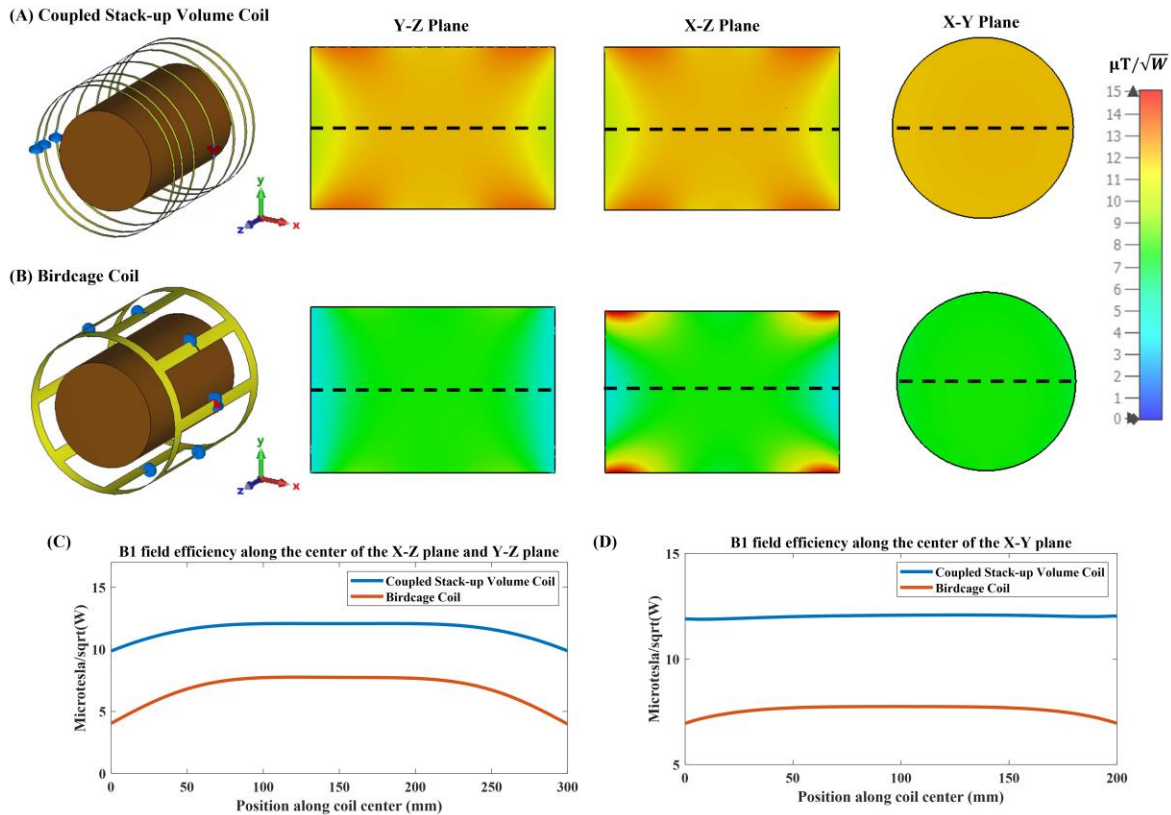

481  
 482 **Figure 9.** Simulated B1 efficiency and field distribution in three orthogonal planes: Comparison  
 483 between the (A) proposed coupled stack-up volume coil and the (B) birdcage coil loaded with  
 484 an oil phantom. (C) 1-D profiles of the simulated B1 fields plotted along the axis of the coils, i.e.  
 485 the dashed lines indicated in Y-Z plane and X-Z plane in inset (A) and (B). (D) 1-D profiles of the  
 486 simulated B1 fields of the coils plotted along the dashed lines shown in X-Y plane in inset (A)  
 487 and (B).

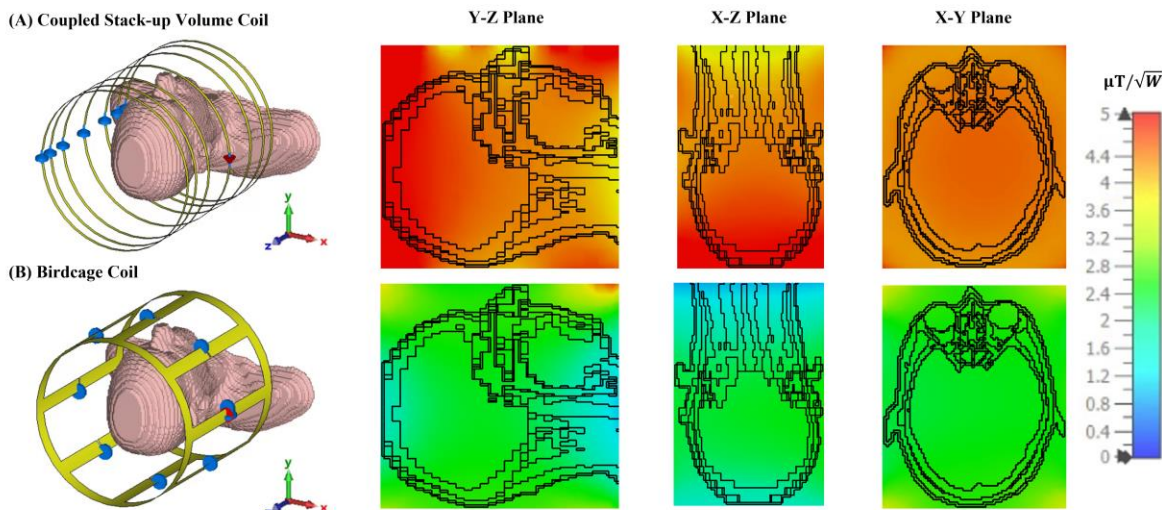

488  
 489 **Figure 10.** Simulated B1 efficiency and field distribution in three orthogonal planes: Comparison  
 490 between the (A) proposed coupled stack-up volume coil and the (B) birdcage coil loaded with a  
 491 human head phantom.

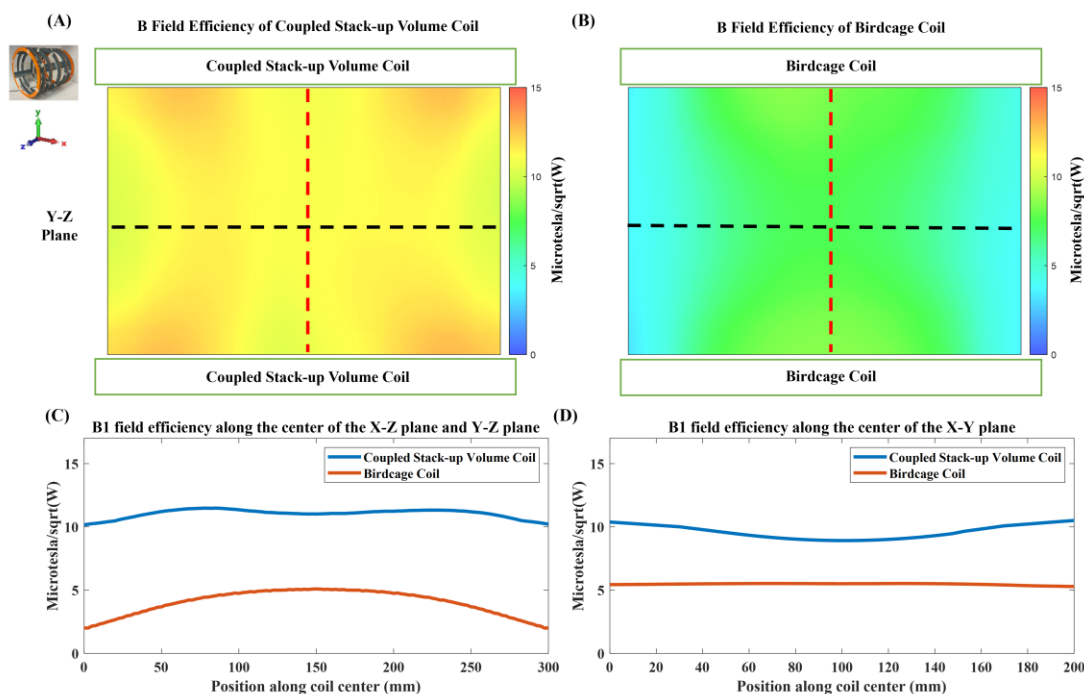

492

493 **Figure 11.** Measured unloaded B1 fields of the proposed coupled stack-up volume coil (A) and  
 494 the same-sized birdcage coil (B). 1D profiles of B1 fields of the two coils plotted along the center  
 495 line of the X-Z plane and Y-Z plane (black dashed lines in (A) and (B)) are shown in (C). 1D  
 496 profiles of B1 fields of the two coils plotted along the center line of the X-Y plane (red dashed  
 497 lines in (A) and (B)) are shown in (D). These results demonstrate the improved B1 efficiency and  
 498 homogeneity of the coupled stack-up volume coil over the birdcage coil at 0.5T.

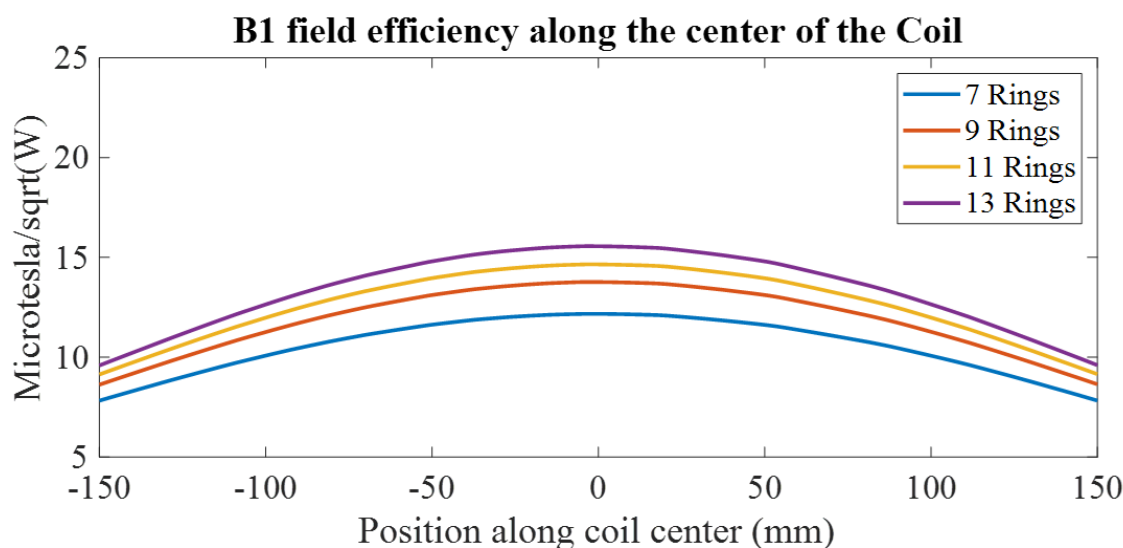

499 **Figure 12.** 1-D profile comparison of the B1 field efficiency for the coupled stack-up volume coil  
 500 with an increased number of rings.  
 501  
 502

### 503 Tables

	Coupled Stack-up Volume Coil	Solenoid Coil	Birdcage Coil
Average B Field Efficiency ( $\mu T/\sqrt{W}$ )	10.82	10.48	7.33
Field Homogeneity (Relative standard deviation)	4.81%	10.02%	15.30%

504

505 **Table 1.** Simulated average B1 field efficiency and standard deviation inside the phantom of  
506 coupled stack-up volume coil, solenoid coil, and birdcage coil. The average B field efficiency and  
507 relative standard deviation are calculated by the simulation result inside the phantom. Field  
508 efficiency is collected and analyzed in a 2.5 mm step size inside the phantom.  
509