

17 **ABSTRACT**

18 Partners resemble each other on many traits, such as health and education. The traits are usually
19 studied one by one in data from established couples and with potential participation bias. We
20 studied all Norwegian parents who had their first child between 2016 and 2020 (N=187,926) and the
21 siblings of these parents. We analysed grade point averages at age 16 (GPA), educational attainment
22 (EA), and medical records with diagnostic data on 10 mental and 10 somatic health conditions
23 measured 10 to 5 years before childbirth. We found stronger partner similarity in mental (median
24 $r=0.14$) than in somatic health conditions (median $r=0.04$), with ubiquitous cross-trait correlations for
25 mental health conditions (median $r=0.13$). GPA correlated 0.43 and EA 0.47 between partners. High
26 GPA or EA was associated with better mental (median $r=-0.16$) and somatic (median $r=-0.08$) health
27 in partners. Elevated correlations for mental health (median $r=0.25$) in established couples indicated
28 convergence. Analyses of siblings and in-laws revealed deviations from direct assortment, suggesting
29 instead indirect assortment based on related traits. Adjusting for GPA and EA reduced partner
30 correlations in health with 30-40%. This has implications for the distribution of risk factors among
31 children, for genetic studies, and for studies of intergenerational transmission.

32

33 **Keywords:** Assortative mating, educational attainment, mental health, somatic health, cross-trait
34 assortment

35

36

37 INTRODUCTION

38 Assortative mating, the non-random matching of partners, is commonly studied from the perspective
39 of social inequalities. Strong assortment for educational attainment (EA) is well-documented across
40 disciplines ¹, and partners often resemble each other in mental and somatic health conditions ^{2,3}.
41 Recently, there has been a revived interest in matching across traits ⁴. This is important, because
42 people do not choose their partners based on one phenotype at a time but holistically. We build
43 upon the well-established links between educational attainment and health ^{5,6} and investigate
44 assortative mating patterns within and between these interconnected phenomena in population-
45 wide data. This provides insight into the clustering of education and health within families.

46
47 A comprehensive catalogue of partner correlations, based on the UK Biobank, presented partner
48 similarity in 133 phenotypes, including EA and symptoms of mental disorders ¹. However, previous
49 studies are with few exceptions ² limited to cohort samples with healthy volunteer selection bias ⁷.
50 Issues related to selective non-participation are amplified in studies of couples, as both partners
51 need to participate. In addition, partner correlations are usually assessed at arbitrary relationship
52 stages and may therefore reflect convergence in addition to initial matching, leaving it unclear to
53 what degree partners are similar in mental health at the time of couple formation. Another line of
54 research investigates correlations between partners' genetic risk for mental disorders. Assortment
55 based on heritable mental disorders should lead to genetic correlations between partners, and since
56 the genes are determined before the couples are formed, correlations should be independent of
57 convergence. These studies report null findings for mental disorders ^{8,9}, except for schizophrenia ¹⁰.
58 Such findings could imply that mental health does not influence partner selection. Despite a century
59 of research on assortative mating, it is still questioned whether there is "really assortative mating on
60 the liability to psychiatric disorders" ¹¹. Even less is known about assortment for somatic health.
61 Good somatic health is a desired trait in partners ¹², but it is unclear how similar partners are in
62 somatic compared to mental health. Our first aim was therefore to assess partner similarity in
63 education and mental and somatic health using population-wide prospective data.

64
65 Cross-trait assortment refers to non-random matching across different traits in the two partners ¹³.
66 Due to the competition for mates and attractiveness trade-offs, one should expect partner
67 correlations to arise across different generally attractive traits, such as income and body mass ¹⁴. The
68 econometric research on cross-trait assortment has centred on such trade-offs ^{14,15}, whereas the
69 genetic research has seen cross-trait assortment as a source of genetic correlations ^{4,16}. Assortment
70 across traits can lead to correlations between genetic ⁴ and environmental influences on different
71 traits ¹⁷, which in turn can contribute to comorbidity and familial clustering of multiple disorders ¹⁸.

72 Beyond genuine increases in correlations between genetic liabilities, cross-trait assortment can also
73 violate assumptions and bias genome-wide association and Mendelian randomization studies ¹⁹.
74 However, we are not aware of any studies examining cross-trait assortment for education and health
75 phenotypes in representative samples. Addressing this gap, our second aim was to determine the
76 degree of cross-trait assortment for education and a broad selection of health conditions.

77

78 Partner similarity can arise from several potentially co-occurring processes. In Figure 1, we outline
79 these processes and the role they play in the present paper. First, *direct assortment (or primary*
80 *phenotypic assortment)* means that partners resemble each other in a trait because the observed
81 trait influences partner selection (panel A). Direct assortment is a sufficient explanation for partner
82 similarity in height ²⁰⁻²². Second, *indirect assortment (also called secondary assortment)* refers to
83 similarity in a trait resulting from selection on a correlated trait, which may be unknown (panel B) or
84 known (panel C). For instance, similarity in a specific mental disorder could arise from assortment on
85 psychiatric vulnerability. If one trait, such as attractiveness, underlies assortment for multiple other
86 traits, cross-trait assortment can be observed for these other traits. Direct assortment on an
87 imperfectly measured phenotype can statistically resemble indirect assortment on an unobserved
88 phenotype ²⁰. In such cases, assortment may be said to be direct for the trait of interest, but indirect
89 for the indicator. Third, *social stratification (or social homogamy)* refers to individuals selecting each
90 other based on environmental proximity, which incidentally make them similar in the phenotype of
91 interest (panel D). Social stratification has been found to play a small to moderate role in partner
92 similarity in EA ²³⁻²⁵. Fourth, *convergence* refers to partners becoming more similar over time, either
93 because they influence each other or because they share environments (panel E). Convergence has
94 been found for lifestyle choices such as alcohol consumption and exercise ²⁶. Convergence is not a
95 form of assortment, but an alternative explanation of partner similarity.

96

97 Each mechanism has different genetic and environmental consequences and can bias genetic ^{18,21}
98 and intergenerational studies in different ways. The optimal adjustment for assortative mating
99 depends on the underlying process, which is often unknown. Direct assortment on the observed
100 variable is typically assumed, although several studies have found deviations from direct assortment
101 for EA ^{20,21,25} and one study found deviations from direct assortment in 29 of 51 studied traits ²⁷. We
102 have previously shown that adding siblings data can inform on mechanisms ²⁰. Our third aim was
103 therefore to determine whether partner resemblance across a range of health phenotypes is
104 consistent with direct assortment.

105

106 Assortative mating related to EA could be particularly important. EA relates to most health conditions
107 and has higher partner similarity than most other traits ^{1,28}. Assortative mating based on EA could
108 lead to partner similarity in health phenotypes due to indirect assortment. Assortment based on EA is
109 also a potential explanation for cross-trait correlations between different health conditions, when
110 both conditions are related to EA. However, high EA is achieved in adulthood, potentially after
111 meeting a partner, and may be influenced by convergence. Therefore, assortment may not take
112 place on EA itself, but its precursors. We here additionally use grade point average (GPA) at age 16 as
113 an early precursor of EA. Our fourth aim was to determine to what degree assortment on health
114 phenotypes is indirect via assortment on EA or its early indicator, GPA.

115

116 In summary, we analysed educational and medical records for the parents of all first-born children
117 born between 2016 and 2020 to parents living in Norway. Our approach had four key advantages:
118 Population-wide data with no participation bias, early assessment, comprehensive phenotype data
119 from primary care, and data from siblings as well as partners. First (aim 1), we studied partner
120 similarity in education, mental, and somatic health conditions. To limit the role of convergence, we
121 observed health 10 to 5 years before couples had their first child. We found positive partner
122 correlations for all conditions, which were higher for mental than for somatic health conditions.
123 Correlations were higher in established couples, indicating convergence. Second (aim 2), we found
124 widespread cross-trait assortment. Education in one partner was linked with mental health in the
125 other partner and assortment across different mental health conditions were widespread. Third (aim
126 3), by analysing correlations among siblings and siblings-in-law, we found frequent deviations from
127 direct assortment. As we deal with convergence by design, deviations from direct assortment must
128 be due to either indirect assortment or social stratification. Fourth (aim 4), we explored whether
129 partner resemblance in health could be explained by assortment on GPA or EA. Adjusting for both
130 partners' GPA or EA reduced correlations in health with 30-40%.

131

132 **RESULTS**

133 Descriptive statistics

134 Our study was based on the complete Population Register of Norway. We defined as partners all
135 pairs of opposite-sex individuals registered as parents for the first time between 2016 and 2020
136 (187,926 individuals in 93,963 couples). We examined 10 mental and 10 somatic health conditions in
137 primary care records. These were measured 5 to 10 years before a couple had their first child to
138 minimize effects of convergence. Women were on average 19.61 and men 21.96 years old at the
139 start of the observational period. GPA was observed at age 16 and EA at age 30 or in 2020 for
140 younger individuals.

141
142 Table 1 presents the prevalence of the mental and somatic health conditions, as well as conditional
143 prevalence rates among relatives of affected individuals. Partners, siblings, and in-laws of affected
144 individual generally had heightened risks of having the same conditions. Figure 2 illustrates these
145 prevalence rates among females and males with unaffected and affected partners. Those with an
146 affected partner were more likely to have the condition themselves, although the strength of this
147 association varied considerably by condition. The within-individual correlations for the educational
148 outcomes and the 20 health conditions are presented in Supplemental Figure S1. Mental health
149 conditions exhibited stronger inter-correlations and also demonstrated larger associations with
150 education than did the somatic health conditions. Within-person associations from logistic regression
151 analyses are presented as odds ratios in Supplemental Figure S2.

152
153 Partner correlations within mental and somatic health conditions (aim 1)

154 Figure 3 shows in dark blue the partner correlations in educational outcomes and 20 health
155 phenotypes (10 mental and 10 somatic) observed 5 to 10 years prior to the couple's first child. This
156 prospective analysis revealed positive partner correlations for all the included traits, ranging from
157 0.02 (allergic rhinitis) to 0.56 (substance use disorder). Notably, all the mental health conditions had
158 higher partner correlations than all the somatic health conditions. The median partner correlation
159 was 0.14 for mental health conditions and 0.04 for somatic health conditions. GPA correlated 0.43
160 and EA correlated 0.47 between partners.

161
162 Cross-sectional assessment yields higher within-trait correlations than prospective assessment

163 To address the potential impact of convergence, we also conducted a cross-sectional analysis of the
164 10 mental and 10 somatic health conditions from 2015 to 2019, when the couples were likely already
165 established. These cross-sectional analyses disregard the timing of childbirth. Figure 3 contrasts
166 these cross-sectional correlations (shown in red) with the prospective correlations. The correlations
167 between partners' mental health conditions increased notably from a median of 0.14 in prospective
168 analyses to a median correlation of 0.25 in cross-sectional analyses ($\Delta-2LL = 211.40$, $\Delta df=10$, $p <$
169 $1.00e-99$). For somatic health conditions, the increases were more modest, from 0.04 to 0.06 ($\Delta-2LL$
170 $= 63.05$, $\Delta df = 10$, $p = 9.55e-10$). Supplemental Tables S2-S3 and Supplemental Figures S4-S9 provide
171 complete results for the cross-sectional assessment.

172
173 Partner correlations across different mental and somatic health conditions (aim 2)

174 Returning to the prospective analyses, we investigated partner correlations across educational,
175 mental, and somatic phenotypes. We found that partner correlations were ubiquitous across

176 different mental health conditions. Figure 4 illustrates the partners correlations within and across all
177 22 phenotypes, whereas Table 2 summarises median correlations for different categories of
178 phenotypes. EA and GPA correlated 0.66 within individuals, implying that 56% of the variance in EA
179 was not shared with GPA. Yet, the associations of either GPA or EA with health conditions were
180 remarkably similar. Higher GPA or EA was generally associated with a lower risk of most health
181 conditions in the partner, except for acne, allergic rhinitis, and naevus/mole which had negligible
182 associations in the other direction. These conditions were also related to higher education or better
183 grades within individuals (see Supplemental Figure S1).

184
185 The median correlations between education and mental health conditions in the partner was -0.16 to
186 -0.17, depending on sex and the educational outcome. All mental health conditions were associated
187 with all other mental health conditions in the partner, indicating widespread cross-trait assortment.
188 The median partner correlation across different mental health conditions was 0.13, close to the
189 within-phenotype correlation of 0.14. In contrast, most somatic conditions showed little to no
190 relation to mental health conditions in partners, with a few exceptions (median correlation 0.03), and
191 the cross-trait correlation for somatic conditions was minimal with a median at 0.01. Table 2 presents
192 median correlations within and between different phenotype categories for the cross-sectional
193 analyses. In the cross-sectional analyses, most cross-trait correlations were marginally higher,
194 between 0.01 to 0.03, compared to the prospective analyses. We did not observe any noteworthy
195 differences in the correlations between male and female traits. Supplemental Figure S3 presents the
196 within and across trait associations as odds ratios. Results were similar to the correlation analyses
197 and indicated widespread cross-trait associations for educational outcomes and mental health
198 conditions.

199
200 Testing if associations are in line with direct assortment (aim 3)
201 We then explored whether the partner correlations were in line with direct assortment on the
202 observed traits. Under direct assortment, the correlation between indirectly related individuals, such
203 as siblings-in-law, should equate the product of the correlations that connect them, in this case
204 partners and siblings. Among the 187,926 parents in our sample, 156,335 had a sibling, resulting in
205 an equal number of sibling-in-law observations. The probability of having university education
206 depended not only on the partner's education, but also the partner's sibling's educational level.
207 When the partner did not have university education, 44.5% had university education if the partner's
208 sibling had university education, but only 28.1% if the partner's sibling did not. Conversely, when the
209 partner did have university education, these numbers were 75.5% and 60.6%, depending on the
210 partner's sibling's education.

211
212
213
214
215
216
217
218
219
220
221
222
223
224
225
226
227
228
229
230
231
232
233
234
235
236
237
238
239
240
241
242
243
244
245

We statistically tested whether siblings-in-law correlation matched the expectation under direct assortment. Table 3 presents the correlations for partners, siblings, and siblings-in-law in all the 22 traits, as well as the ‘in-law inflation factor’, which compares the observed in-law correlations to those predicted under direct assortment. It was calculated by dividing the observed correlations between siblings-in-law by the product of the sibling and partner correlations. This was above 1.00 for 20 of 22 phenotypes, indicating that direct assortment cannot account for the observed correlations. False discovery rate adjusted p-values indicated statistically significant deviations from direct assortment at the $\alpha=0.05$ level for GPA, EA, 3 mental health conditions, and 4 somatic health conditions. Logistic regression presented in Supplemental Table S1 indicated independent associations with siblings-in-law for the two educational outcomes, 5 mental and 4 somatic health conditions, after accounting for partner associations. This concurs with deviations from direct assortment.

Indirect assortment on health via assortment on educational attainment (aim 4)

We proceeded to test whether assortment on GPA or EA could drive partner similarity in health. Figure 3 shows the residual partner correlations after adjustments for GPA (in base blue) or EA (in green). The partner correlation in EA adjusted for GPA was twice as strong ($r=0.29$) as the partner correlation in GPA adjusted for EA ($r=0.15$), suggesting that EA is more strongly related to assortment than GPA is. For mental disorders, the median partner correlations were reduced from 0.14 to 0.11 after adjustment for GPA (down 21.6%) and to 0.10 after EA adjustment (down 31.0%). The median partner correlation for somatic disorders was already low at 0.04, and remained at 0.04 (down 12.0%) after adjustment for GPA and was reduced to 0.03 (down 29.1%) after adjustment for EA.

Assortment on GPA or EA could also influence cross-trait partner correlations. Table 2 summarizes the median correlations and Figure 5 and Figure 6 provide the complete correlation matrices after adjustment for GPA and EA, respectively. The median partner correlation between different mental health conditions was reduced from 0.13 to 0.08 (down 32.2%) after adjustment for GPA and to 0.07 after adjustment for EA (down 41.1%). The median partner correlation between different somatic disorders was stable at 0.01.

DISCUSSION

Studying the complete set of first-time Norwegian parents, we found positive partner correlations in GPA, EA, and all analysed mental and somatic health conditions, observed from 10 to 5 years before the birth of a couple’s first child. The initial similarity and later convergence were larger for mental

246 than somatic health conditions. We also observed ubiquitous cross-trait correlations for mental
247 health conditions, which in prospective analyses were approximately as large as the within-trait
248 correlations. The pattern of correlations between relatives indicated deviations from direct
249 assortment on several of the observed phenotypes. Although partner correlations could be partially
250 explained as by-products of assortment related to education, this cannot be a primary explanation of
251 partner correlations in mental health.

252

253 Mental health in early adulthood associates with partner selection

254 Our study expands on previous research by including the whole population, studying diagnosed
255 health conditions, and contrasting the importance of mental versus somatic health conditions. To
256 minimize the influence of convergence, we examined young adults before parenthood and typically
257 before partnership formation. We demonstrate that partners resemble each other in mental health
258 before they are likely to have met. As far as we are aware, partner resemblance in mental health
259 assessed before couple formation has previously only been found for self-reported symptoms in a
260 cohort study²⁹. Our prospective analyses and use of proper diagnoses indicate that there is
261 assortment on the liability to mental disorders, as questioned by Yengo¹¹. The lack of correlations
262 between partners' polygenic indices in previous studies is likely due to limited discovery samples and
263 small effects of each causal variant, giving the polygenic indices low predictive value for mental
264 health conditions. An alternative explanation is that overrepresentation of healthy and well-
265 educated individuals in cohort studies restricts the range and downwardly bias partner correlations.
266 For example, we observed a partner correlation of 0.48 for EA, compared to 0.42 in a Norwegian
267 cohort²⁰. However, for mental health, our estimates of correlations between partners-to-be was
268 slightly lower (median $r=0.13$) than in a cohort study assessing global mental health among future
269 partners ($r=0.16$)²⁹. Our study indicated that mental health conditions were more strongly related to
270 partner selection than somatic health conditions common in young adulthood. This is not surprising,
271 given that mental health is linked with marriage and fertility³⁰ and could indicate desirability to
272 potential partners.

273

274 Partner correlations in mental health were considerably higher at the end than at the start of the
275 observational period. This highlights that studies on established couples can typically only inform on
276 correlations, and that convergence needs to be addressed before interpreting correlations as
277 indicative of assortment^{2,16}. This increase does not necessarily reflect mutual influences or shared
278 experiences; it could also be that partner selection is based on vulnerabilities to mental disorders
279 that manifest as diagnosable conditions later in life (indirect assortment). We observed a change in

280 resemblance from 10 to 5 years before childbirth until the years surrounding childbirth in the same
281 couples – the increased resemblance may be even more pronounced among older couples.

282

283 Assortment across mental health conditions is ubiquitous

284 The cross-trait correlations for different mental health conditions in the two partners were almost as
285 strong as within-trait correlations (median $r=0.14$ vs 0.13). Hence, individuals tend to mate with
286 partners who share similarly good or poor mental health, with the specific type of health condition
287 being subordinate. Such results align with assortment on perceived attractiveness, itself influenced
288 by both mental and educational traits. Thus, the partner correlations observed across different traits
289 likely reflect indirect assortment. Our results differ from a study that found assortment primarily on
290 symptoms of specific disorders⁸. However, that study used data on established couples, which,
291 according to our results, have increases in within-trait correlations.

292

293 The positive manifold across mental health conditions in partners can in the next generation increase
294 genetic correlations between traits; not because the same set of genes are associated with different
295 traits, but because genetic liabilities to different traits co-occur in the same individuals⁴. This can
296 contribute to the frequently observed “p-factor”³¹. In addition, cross-trait assortment can easily lead
297 to bias in genetic studies, as unmeasured genetic variants can be related to measured variants as
298 well as the outcome of interest. This can inflate estimates in genome-wide association studies and
299 violate the exclusion criteria in Mendelian randomization studies¹⁹. In the presence of cross-trait
300 assortment, the results of such studies should be interpreted with caution.

301

302 Individuals with better grades or higher education were less likely to have partners with mental and
303 somatic health conditions. This suggests a trade-off between different attractive traits in partners,
304 indicating competition for healthy partners rather than matching on similarity. Nevertheless, the
305 remarkably high correlation for substance use disorder could indicate genuinely different lifestyle
306 preferences. Modelling of variations in preferences may be vital to fully understand cross-trait
307 assortment^{3,32}. There was little assortment across different somatic conditions or across mental and
308 somatic conditions. Still, most correlations were positive, and mostly so among those involving
309 various types of pain, possibly reflecting the mental aspect of pain. Regardless of genetic
310 consequences, the widespread cross-trait assortment could enhance negative consequences for
311 children, as they may be influenced by both low education and poor mental health in their parents
312 ^{33,34}.

313

314 Partner correlations are generally inconsistent with direct assortment

315 When accounting for assortative mating to avoid bias, studies make assumptions about the
316 mechanisms involved. Typically, they assume direct assortment on the observed variables^{35,36}. Our
317 results challenge this notion. The siblings-in-law correlations exceeded those expected under direct
318 assortment, suggesting that direct assortment is not a sufficient explanation for partner resemblance
319 and that studies relying on this assumption can be biased. Deviations from direct assortment has
320 previously been reported for EA^{20,24,25,37}. We extended this observation to GPA and a range of health
321 conditions. Our results align with another study that observed deviations from direct assortment in
322 29 of 51 traits²⁷, mainly different traits than those studied here.

323
324 Although the phenotypic model could be falsified, the underlying mechanisms remain elusive. Both
325 indirect assortment and social stratification³⁸ could increase in-law correlations disproportionately
326 and explain our observations. In any case, partner resemblance is not solely due to assortment based
327 on the observed phenotypes. Whether parts of the partner correlations in mental health are due to
328 causal influences on partner choice remains to be determined. Identifying the traits that actively
329 determine assortment is an important question for future studies. It might be more strongly related
330 to general vulnerability to psychopathology³¹ than to specific disorders. Due to the strong cross-trait
331 assortment, such causal effects may be more plausible at the level of general mental health, rather
332 than for specific diagnoses. A previous study indicated that partner similarity in many traits was
333 driven by assortment on a few key traits³⁸, but it did not include mental disorders. Future studies
334 may explore whether partner resemblance across many traits can be more parsimoniously explained
335 by assortment on one or a small number of dimensions.

336
337 Indirect assortment need not be based on symmetric assortment on a manifest phenotype.
338 Measurement error can be indistinguishable from indirect assortment on an unknown trait.
339 Assortment may then be said to be direct for the true values of a trait, but indirect for an imperfect
340 indicator. As measurement error is widespread and relatively easy to estimate, accounting for
341 measurement error could improve future studies on assortment. Indirect assortment could also be
342 related to impression management, whereby partner selection could take place on successful
343 misrepresentations of one's characteristics. This should, however, not influence sibling correlations.
344 Finally, correlations in trait preferences among siblings can increase correlations between distant
345 affines, such as co-siblings-in-law³². Hence, models of preferences may be needed to fully
346 understand similarities in wider family networks.

347

348 Assortment leads to correlations between all genetic and environmental influences in one partner
349 and those in the other. When parental traits leave a mark on their children through vertical
350 transmission, this assortment leads to an intertwining of genetics and environment in the children.
351 This can substantially increase gene-environment correlations in the child generation, which again
352 increases the genetic similarity between partners⁹ (formula S1.8). If there is indirect assortment, the
353 partner similarity in assorted factors will be larger than indicated by the observed variables, and the
354 intergenerational consequences can be underestimated. Intergenerational studies therefore need to
355 carefully model indirect assortment. Regardless of mechanism and possible genetic consequences of
356 assortative mating¹⁸, the potential social consequences of partnership composition could remain.

357

358 Assortment on educational attainment partially explains health similarity

359 Given the known correlation between education and health status, one should expect a partner with
360 higher education to, on average, also enjoy better health. Indeed, when we adjusted for both
361 partners' GPA or EA, partner correlations within and across mental disorders were reduced. Hence,
362 similarity in mental health could to some degree be by-products of on education or its precursors.
363 Nevertheless, correlations within and across mental disorders remained significant, indicating that
364 these were not solely by-products of assortment based on education. Hence, mental health is related
365 to partner selection independently of observed education. Partner correlations within and across
366 different somatic health conditions were close to zero both before and after these adjustments.

367

368 It must be noted that EA was not measured prospectively; at the young age of approximately 20
369 years, many individuals are yet to obtain their highest education. Individuals can select partners
370 based on the traits that that exist at this age and that lead to later EA, in which case the adjustment
371 is defensible. However, it is also possible that the adjustment for EA is an overadjustment because
372 one's own or the partner's health could influence education. Using GPA as an alternative indicator of
373 educational potential reduces this issue because it is typically achieved before partners meet.
374 However, each partner's mental health could have influenced their own GPA, meaning that the true
375 assortment on mental disorders could in principle be slightly larger than indicated by our study. GPA
376 was somewhat less strongly linked to the partner's health than EA was. This could suggest that traits
377 that influence EA are more important for mate choice than traits influencing GPA. Interestingly,
378 siblings were more similar in GPA than EA, but this was reversed in partners. Cognitive abilities and
379 conscientiousness influence both GPA and EA, but there could be differences in ambitions, achieved
380 status, or social background. Roughly half of the variance in EA was not shared with GPA, indicating
381 that there are important differences between the two.

382

383 The current study indicates, as do also previous studies ^{20,25}, that the strong partner resemblance in
384 EA is due to even stronger resemblance in an unobserved factor. This was also the case for GPA.
385 Assortment for EA and GPA was itself indirect; therefore, unidentified factors must exist that
386 contribute to partner similarity in education as well as in health. This aligns with a previous study that
387 chain-linked in-laws and inferred far greater partner similarity in latent (unidentified) advantages
388 than in the observed level of education ²⁵. Our inclusion of GPA early in life is novel, however, it did
389 not capture these latent factors any better than EA. Future research could try to identify traits that
390 account for the sorting process and understand how they relate to partner similarity across observed
391 traits. This may include social status more broadly defined or health in childhood.

392

393 Limitations

394 This study has some limitations that one should consider when interpreting the findings. First, the
395 medical records are proxies for actual health conditions, as not all individuals with health issues seek
396 medical care. This prevented the study of conditions below the threshold of medical attention. This
397 issue is reduced as the tetrachoric correlations model these thresholds. Also, our use of primary care
398 data captures a larger proportion of cases than specialist care data alone ³⁹, which has been used in
399 previous studies ². This further mitigates potential biases. We could only study somatic conditions
400 that were common among parents-to-be in young adulthood. The results are not necessarily
401 representative for other somatic health conditions; in particular, assortment on rare health
402 conditions is unknown. This also prevented the study of health conditions with a higher average age
403 of onset, such as cardiometabolic conditions and cancers. However, conditions that develop after
404 couple formation cannot directly influence its composition. Second, our focus on parents of children
405 born in Norway between 2016 and 2020 could limit the generalizability to other populations or time
406 periods. Third, we cannot rule out that some partners had already influenced each other at the start
407 of the observational period in early adulthood. Nevertheless, the prospective nature of our study is a
408 major advancement over previous studies, and the comparison with cross-sectional data emphasizes
409 the impact of this analytic decision. The gap of 5 years between the end of health observation and
410 the birth of the first child exceeds the median duration of relationships, suggesting that most couples
411 were unacquainted during the health observation period. Fourth, we used tetrachoric correlations,
412 based on the assumption of an underlying normally distributed liability. Whereas this could be
413 reasonable for mental health conditions, some somatic health conditions are binary in their nature,
414 such as fractures. This could lead to an over-estimation of partner correlations. However, this would,
415 if anything, make the difference between mental and somatic health conditions larger. In addition,
416 this did not affect the tests of direct assortment (Supplemental Scripts S1-S2), and results were
417 consistent in logistic regression.

418

419 Conclusion

420 In conclusion, this study provides evidence for assortative mating patterns across GPA, EA, and 20
421 health conditions, up to 10 years before partners had their first child in data without participation
422 bias. Among the health conditions, mental health conditions were particularly strongly related to
423 partner selection. We observed vast cross-trait assortment for mental health conditions, indicating
424 that individuals match on overall mental health, rather than on specific health conditions. The link
425 with education might indicate trade-offs for overall attractiveness. This questions assumptions in
426 genetic designs and could have consequences for the distribution of risk factors among children. In
427 general, partner resemblance could not be explained with direct assortment, however, GPA or EA
428 could only to a moderate degree account for partner similarity in mental health. The use of
429 prospective data ensured that partner resemblance was not merely due to convergence, and the
430 comparison with cross-sectional data indicates that studies without prospective data do not precisely
431 reflect assortative mating. Indirect assortment appears the best explanation for partner similarity,
432 raising important questions on mate choice and complicating modelling of partner similarity.

433

434 **METHODS**

435 Sample and design

436 The Population Register of Norway consisted of 8,589,458 individuals born between 1855 and 2020
437 who were alive and living in Norway after 1964. We combined this with information on publicly
438 funded health care, available from 2006 to 2019. We defined a couple as the two registered parents
439 of a child and studied all opposite-sex parent-pairs who had their first child born between 2016 and
440 2020. This led to observation of 93,963 couples and 187,926 parents. Only opposite-sex parents were
441 included in the sample, as partner similarity in same-sex couples warrants separate studies. We
442 included only couples who were both registered as living in Norway for the 10 to 5 years prior to the
443 child's birth. For each parent, we drew a random full-sibling. Among the 187,926 parents, 156,335
444 had a sibling, hence, we also had data on an equal number of pairs of siblings-in-law. In 65,902 cases,
445 both partners had siblings.

446

447 We observed health of the parents from 10 to 5 years prior to the birth of their child. For instance,
448 for a child born in January 2016, we observed health from January 2006 to December 2010, whereas
449 for a child born in December 2020, we observed health from December 2010 to November 2015. The
450 five-year lag between health observations of parents and the child's birth was intended to limit the
451 influence of convergence on the results, by measuring them early in the relationship. Although some
452 parents will have known each for longer, the duration of the sexual relationships with the father

453 before the first pregnancy had a median of 4 years (first quartile: 2 years; third quartile: 6 years)
454 among 31,651 mothers in the Norwegian Mother, Father, and Child Cohort Study (original data
455 analyses, a general description of the sample has been provided previously⁴⁰). To study convergence,
456 we additionally observed health in the last five years available, from 2015 to 2019 for all couples
457 regardless of when they had their first child. This is around the time they had their first child. The
458 mean birth year was 1988 for mothers and 1986 for fathers. Mothers were on average 29.61 and
459 fathers 31.96 years old when they had their first child (19.61 and 21.96 at the start of the
460 observational period).

461

462 Ethics

463 The study was approved by The Regional Committees for Medical and Health Research Ethics,
464 Southern and Eastern Norway (project #2018/434).

465

466 Measures

467 *Educational attainment*

468 Educational attainment was available in eight categories, ranging from “no education” to “Ph.D.”,
469 coded according to the Norwegian Classification of Education. We used educational attainment at
470 age 30 or the highest educational attainment at the end of the observational period as a continuous
471 variable after recoding it into years of completed education.

472

473 *Grade point average*

474 Norwegian students are evaluated at the end of compulsory education, usually the year they turn 16.
475 The Grade Point Average (GPA) is calculated as the average of all final-year teacher evaluated grades
476 and externally graded exams. The GPA is used for ranking students applying for admission to upper
477 secondary education. Students therefore have an incentive to perform well. We standardized the
478 GPA score (mean=0, SD=1) within each birth year cohort to adjust for grade inflation. Even the lowest
479 grades go into the GPA score, also those that would not be considered passing at a higher level of
480 education. This means that nearly all students have a valid GPA. GPA was available for individuals
481 born in 1985 or later. In total 77.4% of mothers (n=72,727) and 64.3% of fathers (n=60,412) had
482 valid GPA scores. GPA was used as a continuous variable.

483

484 *Mental and somatic health*

485 All persons who legally reside in Norway are members of the National Insurance Scheme and
486 assigned a general practitioner. General practitioners and other health service providers, such as
487 emergency rooms, send billing information to a governmental organization along with a diagnosis or

488 reason for the visit in order to receive reimbursements. Due to economic incentives, it is unlikely that
489 health visits go unreported. Diagnostic information is coded according to the International
490 Classification of Primary Care (ICPC-2)⁴¹. The ICPC-2 contains both diagnoses and complaints. Linkage
491 between data sources is possible via the unique national identity number.

492

493 We analysed 20 health conditions, of which 10 were mental health conditions. These covered a
494 broad spectre of mental health conditions, corresponded to well-known conditions, and were
495 sufficiently common to be analysed in both sexes. These analysed conditions were Depressive
496 disorder, Anxiety disorders, Phobia/compulsive disorder, Acute stress reaction, Sleep disturbance,
497 Alcohol use disorders, Substance use disorders, Hyperkinetic disorder (ADHD), Psychotic disorders,
498 and Personality disorder. Likewise, we analysed 10 somatic health conditions. They were selected for
499 their diversity in covering different health issues and for being sufficiently prevalent in both sexes in
500 our sample of young adults who later became parents. The included conditions were Headaches,
501 Neck/back symptom/complaint, Abdominal pain/cramps general, Fractures, Acne, Injury
502 musculoskeletal, Asthma, Allergic rhinitis, Laceration/cut, Naevus/mole. If at least one entry with the
503 code was present between 10 and 5 years before the birth of the first child, the person was defined
504 as having the condition. The ICPC-2 codes included in each condition are listed in Table 1.

505

506 Statistical analyses

507 We first described the prevalence of the health conditions by relationship type (partners, siblings,
508 siblings-in-law). We then calculated correlations between partners (aim 1) while adjusting for birth
509 year. We used OpenMx to estimate the correlations using Full Information Maximum Likelihood
510 (FIML), thereby using all available data, whether complete or incomplete. Adjustments were made by
511 adding the definition variables with slopes to means of the models. For the binary variables (all
512 except GPA and EA), we used a liability threshold model. Hence, we used tetrachoric correlations for
513 associations involving binary health outcomes, polyserial correlations for the associations involving
514 GPA or EA and binary health outcomes, and Pearson correlations for associations involving only GPA
515 and/or EA. We then estimated associations between different phenotypes in the two partners (aim
516 2) in a corresponding manner.

517

518 We then calculated correlations between siblings and siblings-in-law and compare these to the
519 partner correlations to test whether the results were consistent with direct assortment on the
520 observed traits (aim 3). Under direct assortment, the correlation for siblings-in-law (r_{inlaw}) equals
521 the product of the correlations for partners ($r_{partner}$) and siblings ($r_{sibling}$). We have elaborated on
522 this and provided supporting simulations previously²⁰. By testing if the observed correlations

523 adhered to this pattern, we can detect deviations from direct assortment. We define an in-law
 524 inflation factor (IIF) as the ratio of the correlation between siblings-in-law to the expectation under
 525 direct assortment

526

$$527 \quad IIF = \frac{r_{inlaw}}{r_{sibling} * r_{partner}}$$

528

529 Figure 7 displays four processes that can lead to partner similarity and allows path tracing expected
 530 correlations, and hence IIF, in the different scenarios. We here consider their implications in
 531 isolation, although combinations of the mechanisms are possible. Direct assortment (panel A of
 532 Figure 7) assumes that partnerships are based on the observed phenotype. By applying path tracing
 533 rules allowing for co-paths³⁶ to Figure 7, one can see that $r_{partner} = m$, $r_{sibling} = r_s$, and $r_{inlaw} =$
 534 mr_s . Hence, $IIF = \frac{r_{inlaw}}{r_{partner} * r_{sibling}} = \frac{mr_s}{m * r_s} = 1$, and deviations from 1.00 are not consistent with direct

535 assortment. For simplicity, we assume unit variance. Social stratification (panel B of Figure 7)

536 influences all individuals to the same degree, and in isolation leads to $r_{partner} = q^2$, $r_{sibling} = q^2$,

537 $r_{inlaw} = q^2$, and $IIF = \frac{r_{inlaw}}{r_{partner} * r_{sibling}} = \frac{q^2}{q^2 * q^2} = \frac{1}{q^2}$. Hence, $q \neq 0$ leads to an IIF above 1.00 ($|q| <$

538 1). With indirect assortment (panel C of Figure 7), partners are similar due to assortment based on
 539 an unknown (latent) phenotype. Siblings are similar in the same latent phenotype (r_s) and may share
 540 additional similarity ($E = (1 - a^2)r_e$). In isolation, indirect assortment gives $r_{partner} = a^2\mu$,

541 $r_{sibling} = a^2r_s + E$, $r_{inlaw} = a^2\mu r_m$, and $IIF = \frac{r_{inlaw}}{r_{partner} * r_{sibling}} = \frac{a^2\mu r_m}{a^2\mu * (a^2r_m + E)} = \frac{1}{a^2 + \frac{E}{r_m}}$. When there

542 is not a residual correlation between siblings ($r_e=0$), this reduces to $IIF = \frac{1}{a^2}$, which is always ≥ 1.00

543 as long as $-1 < a < 1$. A large value for E reduces IIF, which will be 1.00 if $r_e=r_m$, and possibly

544 below 1.00 if $r_e > r_m$. However, we consider large values for E to be rare, because it is residualized on

545 the component of a trait that matters to other individuals through mate selection and is further

546 reduced by measurement error. Convergence (panel D of Figure 7) can refer to two processes

547 increasing partner similarity. Shared environments exclusively influence partner correlations (n^2),

548 whereas mutual influences primarily influence partner correlations ($2xa$) while having a smaller

549 effect on in-law correlations ($xr_s a$). Because convergence primarily influence partner correlations, it

550 will increase the denominator and reduce IIF. We do not consider convergence here further, as we

551 deal with by design.

552

553 In sum, an IIF above 1.00 can be explained by both social stratification and indirect assortment,

554 although we cannot distinguish between these processes without additional data. This is a topic for

555 future research. Supplemental Script S3 illustrates the calculation of IIF when several mechanisms co-
556 exist. We tested whether a model assuming direct assortment as the sole source of partner similarity
557 had worse fit to the data than a model with correlations estimated independently for each
558 relationship type, with no assumptions on the source of similarity. We conducted a likelihood-ratio
559 test with 1 degree of freedom. Among couples where both partners had a sibling, the sibling-in-law
560 relations at each side of the family were modelled with the same correlation, whereas the co-sibling-
561 in-law correlations were estimated freely. All models were adjusted for mean sex differences. We
562 accounted for multiple testing and obtained False Discovery Rate (FDR) adjusted p-values using the
563 Benjamini-Hochberg method with the *p.adjust()* function in R.

564
565 The tetrachoric correlations rely on an underlying normal distribution. If the underlying distribution is
566 left-skewed, the tetrachoric correlations can become overestimated. The product of correlations is
567 pivotal for testing deviations from direct assortment. We therefore conducted simulations to
568 determine whether left-skewness affected the product of the correlations (Supplemental Scripts S2
569 and S3). This was not the case. Hence, if the Pearson correlations $r_{ab} * r_{bc} = r_{ac}$ for continuously
570 non-normally distributed variables, then $r'_{ab} * r'_{bc} = r'_{ac}$ holds true for their dichotomized tetrachoric
571 counterparts, even if the individual tetrachoric correlations are overestimated.

572
573 To obtain residual partner correlations after accounting for similarity in education (aim 4), we
574 additionally adjusted the above models for either GPA or EA. This is equivalent to fitting a structural
575 equation model (SEM) to the illustration in panel D of Figure 1, where A_1 and A_2 represent the traits
576 of interest and B_1 and B_2 represent the two partners' education. This does not impose any
577 assumptions on why traits are correlated within an individual. All analyses were run with the health
578 conditions measured prospectively 10 to 5 years before parenthood and again cross-sectionally with
579 health observed in 2015-2019. Using the prospective data, we also estimated the associations
580 between partners, siblings, and siblings-in-law as odds ratios using multiple logistic regression,
581 adjusting for each individual's phenotype. The adjusted association with the siblings-in-law's
582 phenotype tests direct assortment, reasoning that if assortment is based on the phenotype, then the
583 siblings-in-law's phenotype should not relate to the index person's trait once we account for the
584 partner's phenotype.

585

586 **ACKNOWLEDGEMENTS**

587 This work is part of the REMENTA and PARMENT projects and was supported by the Research Council
588 of Norway (#300668 and #334093, respectively). The Research Council of Norway supported RC,
589 NHE, and EY (#288083 and #336078). This work was performed on the TSD (Tjeneste for Sensitive

590 Data) facilities, owned by the University of Oslo, operated and developed by the TSD service group at
591 the University of Oslo, IT-Department (USIT). This work was partly supported by the Research Council
592 of Norway through its Centres of Excellence funding scheme, project number 262700. The project
593 was co-funded by the European Union (ERC, BIOSFER, 101071773). Views and opinions expressed are
594 however those of the author(s) only and do not necessarily reflect those of the European Union or
595 the European Research Council. Neither the European Union nor the granting authority can be held
596 responsible for them. This work was supported by the National Institute of Mental Health R01 Grants
597 MH130448 and MH100141 (MCK).

598

599 **DATA AVAILABILITY STATEMENT**

600 The data for this study encompass educational outcomes and primary care records for entire cohorts
601 of the Norwegian population. Researchers can access the data by application to the Regional
602 Committees for Medical and Health Research Ethics and the data owners (Statistics Norway and the
603 Norwegian Directorate of Health). The authors cannot share these data with other researchers due
604 to the sensitive nature and potential for identification. However, other researchers can contact the
605 authors if they have questions concerning the data or overlapping research projects.

606 **REFERENCES**

- 607 1. Horwitz, T. B., Balbona, J. V., Paulich, K. N. & Keller, M. C. Evidence of correlations between
608 human partners based on systematic reviews and meta-analyses of 22 traits and UK Biobank
609 analysis of 133 traits. *Nat. Hum. Behav.* **7**, 1568–1583 (2023).
- 610 2. Nordsletten, A. E. *et al.* Patterns of Nonrandom Mating Within and Across 11 Major Psychiatric
611 Disorders. *JAMA Psychiatry* **73**, 354–361 (2016).
- 612 3. Conroy-Beam, D. *et al.* Assortative mating and the evolution of desirability covariation. *Evol.*
613 *Hum. Behav.* **40**, 479–491 (2019).
- 614 4. Border, R. *et al.* Cross-trait assortative mating is widespread and inflates genetic correlation
615 estimates. *Science* **378**, 754–761 (2022).
- 616 5. Nordmo, M. *et al.* The educational burden of disease: a cohort study. *Lancet Public Health* **7**,
617 e549–e556 (2022).
- 618 6. Kinge, J. M. *et al.* Association of Household Income With Life Expectancy and Cause-Specific
619 Mortality in Norway, 2005–2015. *JAMA* **321**, 1916 (2019).
- 620 7. Fry, A. *et al.* Comparison of Sociodemographic and Health-Related Characteristics of UK Biobank
621 Participants With Those of the General Population. *Am. J. Epidemiol.* **186**, 1026–1034 (2017).
- 622 8. Ayorech, Z. *et al.* The structure of psychiatric comorbidity without selection and assortative
623 mating. *Transl. Psychiatry* **14**, 1–9 (2024).
- 624 9. Sunde, H. F. *et al.* Genetic similarity between relatives provides evidence on the presence and
625 history of assortative mating. *Nat. Commun.* **15**, 2641 (2024).
- 626 10. Jepsen, O. H. *et al.* Genetic assortative mating for schizophrenia and bipolar disorder. *Eur.*
627 *Psychiatry* 1–24 (2022) doi:10.1192/j.eurpsy.2022.2304.
- 628 11. Yengo, L. Mate choice through a genomic lens. *Nat. Rev. Genet.* 1–1 (2023) doi:10.1038/s41576-
629 023-00605-w.
- 630 12. Tybur, J. M. & Gangestad, S. W. Mate preferences and infectious disease: theoretical
631 considerations and evidence in humans. *Philos. Trans. R. Soc. B Biol. Sci.* **366**, 3375–3388 (2011).
- 632 13. Fisher, R. A. XV.—The Correlation between Relatives on the Supposition of Mendelian
633 Inheritance. *Trans. R. Soc. Edinb.* **52**, 399–433 (1918).
- 634 14. Chiappori, P.-A., Oreffice, S. & Quintana-Domeque, C. Fatter Attraction: Anthropometric and
635 Socioeconomic Matching on the Marriage Market. *J. Polit. Econ.* **120**, 659–695 (2012).
- 636 15. Becker, G. S. A Theory of Marriage: Part I. *J. Polit. Econ.* **81**, 813–846 (1973).
- 637 16. Maes, H. H. *et al.* Assortative mating for major psychiatric diagnoses in two population-based
638 samples. *Psychol. Med.* **28**, 1389–1401 (1998).

- 639 17. Cloninger, C. R., Rice, J. & Reich, T. Multifactorial Inheritance with Cultural Transmission and
640 Assortative Mating II. A General Model of Combined Polygenic and Cultural Inheritance. *Am. J.*
641 *Hum. Genet.* **31**, 176–198 (1979).
- 642 18. Plomin, R., Krapohl, E. & O'Reilly, P. F. Assortative Mating—A Missing Piece in the Jigsaw of
643 Psychiatric Genetics. *JAMA Psychiatry* **73**, 323 (2016).
- 644 19. Brumpton, B. *et al.* Avoiding dynastic, assortative mating, and population stratification biases in
645 Mendelian randomization through within-family analyses. *Nat. Commun.* **11**, 3519 (2020).
- 646 20. Torvik, F. A. *et al.* Modeling assortative mating and genetic similarities between partners,
647 siblings, and in-laws. *Nat. Commun.* **13**, 1108 (2022).
- 648 21. Robinson, M. R. *et al.* Genetic evidence of assortative mating in humans. *Nat. Hum. Behav.* **1**,
649 0016 (2017).
- 650 22. Keller, M. C., Medland, S. E. & Duncan, L. E. Are Extended Twin Family Designs Worth the
651 Trouble? A Comparison of the Bias, Precision, and Accuracy of Parameters Estimated in Four
652 Twin Family Models. *Behav. Genet.* **40**, 377–393 (2010).
- 653 23. Gonggrijp, B. M. A. *et al.* The mechanism of assortative mating for educational attainment: a
654 study of Finnish and Dutch twins and their spouses. *Front. Genet.* **14**, (2023).
- 655 24. Reynolds, C. A., Baker, L. A. & Pedersen, N. L. Multivariate Models of Mixed Assortment:
656 Phenotypic Assortment and Social Homogamy for Education and Fluid Ability. *Behav. Genet.* **30**,
657 455–476 (2000).
- 658 25. Collado, M. D., Ortuño-Ortín, I. & Stuhler, J. Estimating Intergenerational and Assortative
659 Processes in Extended Family Data. *Rev. Econ. Stud.* **90**, 1195–1227 (2023).
- 660 26. Ask, H., Rognum, K., Torvik, F. A., Røysamb, E. & Tambs, K. Non-Random Mating and
661 Convergence Over Time for Alcohol Consumption, Smoking, and Exercise: The Nord-Trøndelag
662 Health Study. *Behav. Genet.* **42**, 354–365 (2012).
- 663 27. Xia, C., Canela-Xandri, O., Rawlik, K. & Tenesa, A. Evidence of horizontal indirect genetic effects
664 in humans. *Nat. Hum. Behav.* **5**, 399–406 (2021).
- 665 28. Baker, L. A., Treloar, S. A., Reynolds, C. A., Heath, A. C. & Martin, N. G. Genetics of educational
666 attainment in Australian twins: Sex differences and secular changes. *Behav. Genet.* **26**, 89–102
667 (1996).
- 668 29. Ask, H., Idstad, M., Engdahl, B. & Tambs, K. Non-random Mating and Convergence Over Time for
669 Mental Health, Life Satisfaction, and Personality: The Nord-Trøndelag Health Study. *Behav.*
670 *Genet.* **43**, 108–119 (2013).
- 671 30. Power, R. A. *et al.* Fecundity of Patients With Schizophrenia, Autism, Bipolar Disorder,
672 Depression, Anorexia Nervosa, or Substance Abuse vs Their Unaffected Siblings. *JAMA Psychiatry*
673 **70**, 22–30 (2013).

- 674 31. Lahey, B. B. *et al.* Is there a general factor of prevalent psychopathology during adulthood? *J.*
675 *Abnorm. Psychol.* **121**, 971–977 (2012).
- 676 32. Eaves, L. The use of twins in the analysis of assortative mating. *Heredity* **43**, 399–409 (1979).
- 677 33. Nordmo, M. *et al.* The association between parental internalizing disorders and child school
678 performance. *Npj Sci. Learn.* **8**, 1–6 (2023).
- 679 34. Kinge, J. M. *et al.* Parental income and mental disorders in children and adolescents: prospective
680 register-based study. *Int. J. Epidemiol.* **50**, 1615–1627 (2021).
- 681 35. Bulmer, M. G. *The Mathematical Theory of Quantitative Genetics*. (Oxford University Press).
- 682 36. Balbona, J. V., Kim, Y. & Keller, M. C. Estimation of Parental Effects Using Polygenic Scores.
683 *Behav. Genet.* **51**, 264–278 (2021).
- 684 37. Okbay, A. *et al.* Polygenic prediction of educational attainment within and between families from
685 genome-wide association analyses in 3 million individuals. *Nat. Genet.* **54**, 437–449 (2022).
- 686 38. Sjaarda, J. & Kutalik, Z. Partner choice, confounding and trait convergence all contribute to
687 phenotypic partner similarity. *Nat. Hum. Behav.* 1–14 (2023) doi:10.1038/s41562-022-01500-w.
- 688 39. Torvik, F. A. *et al.* Diagnostic and genetic overlap of three common mental disorders in
689 structured interviews and health registries. *Acta Psychiatr. Scand.* **137**, 54–64 (2018).
- 690 40. Magnus, P. *et al.* Cohort Profile Update: The Norwegian Mother and Child Cohort Study (MoBa).
691 *Int. J. Epidemiol.* **45**, 382–388 (2016).
- 692 41. *ICPC-2-R: International Classification of Primary Care*. (Oxford University Press, Oxford ; New
693 York, 2005).
- 694

TABLES AND FIGURES

Table 1. List of ICPC-2 codes for the mental and somatic health condition, prevalence in the sample (including education), and prevalence among partners and relatives of affected individuals, 10 to 5 years before the birth of the first child.

Variable	ICPC-2 codes	Index		Partner of affected		Sibling of affected		In-law of affected	
		n	%	n	%	n	%	n	%
University education		93,303	49.84	64,110	68.89	48,682	61.23	46,001	58.16
Grade Point Average among top 20%		26,824	20.15	8,058	37.43	7,654	42.38	5,085	32.38
Substance use disorders	P18, P19	3,006	1.60	524	17.43	184	8.75	127	5.76
Hyperkinetic disorder	P81	4,840	2.58	412	8.51	518	14.67	157	4.25
Personality disorder	P80	877	0.47	20	2.28	13	2.03	<10	
Psychotic disorders	P72, P98, P73	1,420	0.76	44	3.10	47	4.22	18	1.58
Depressive disorder	P76	17,086	9.09	2,378	13.92	2,098	15.92	1,457	10.63
Acute stress reaction	P02	14,288	7.60	1,512	10.58	1,617	14.59	978	8.46
Sleep disturbance	P06	10,109	5.38	834	8.25	698	8.87	484	5.95
Anxiety disorder	P74	6,584	3.50	372	5.65	399	7.84	218	4.15
Alcohol use disorders	P15, P16	3,344	1.78	110	3.29	82	3.18	53	1.99
Phobia/compulsive disorder	P79	2,697	1.44	66	2.45	69	3.20	39	1.78
Neck/back symptom/complaint	L01, L02, L03	35,247	18.76	7,620	21.62	6,155	21.98	5,382	18.71
Injury musculoskeletal	L81	16,043	8.54	1,742	10.86	1,546	11.80	1,219	9.22
Fractures	L72, L73, L74, L75, L76	13,489	7.18	1,188	8.81	1,007	9.10	823	7.46

Variable	ICPC-2 codes	Index		Partner of affected		Sibling of affected		In-law of affected	
		n	%	n	%	n	%	n	%
Naevus/mole	S82	20,382	10.85	2,366	11.61	2,591	15.02	1,853	10.79
Acne	S96	11,145	5.93	790	7.09	1,108	11.80	563	6.04
Laceration/cut	S18	19,170	10.20	1,916	9.99	1,886	11.81	1,611	10.16
Headaches	N89, N90, N01, N95	25,716	13.68	3,226	12.54	3,366	16.26	2,842	13.40
Abdominal pain/cramps general	D01	30,338	16.14	4,354	14.35	4,348	17.96	3,780	15.16
Asthma	R96	12,593	6.70	916	7.27	1,422	13.87	742	7.11
Allergic rhinitis	R97	18,943	10.08	2,030	10.72	2,455	15.53	1,542	9.72

Table 2. Median correlations (r) and median standard errors (SE) within and across traits in different categories.

Trait in female	Trait in male	Within or across traits	Prospective, adjusted for age	Prospective, adjusted for age	Prospective, adjusted for age and GPA	Prospective, adjusted for age and educational attainment	Cross-sectional, adjusted for age			
			Median r	Median SE	Median r	Median SE	Median r	Median SE	Median r	Median SE
EA	EA	Within	0.47	0.00	0.29	0.00	–	–	0.47	0.00
EA	GPA	Across	0.44	0.00	–	–	–	–	0.44	0.00
GPA	EA	Across	0.43	0.00	–	–	–	–	0.43	0.00
GPA	GPA	Within	0.43	0.00	–	–	0.15	0	0.43	0.00
EA	Mental	Across	-0.17	0.01	-0.09	0.01	–	–	-0.19	0.01
Mental	EA	Across	-0.16	0.01	-0.08	0.01	–	–	-0.17	0.01
GPA	Mental	Across	-0.16	0.01	–	–	-0.05	0.01	-0.19	0.01
Mental	GPA	Across	-0.16	0.01	–	–	-0.03	0.01	-0.16	0.01
EA	Somatic	Across	-0.09	0.01	-0.04	0.01	–	–	-0.10	0.01
Somatic	EA	Across	-0.08	0.01	-0.04	0.01	–	–	-0.10	0.01
GPA	Somatic	Across	-0.08	0.01	–	–	-0.01	0.01	-0.10	0.01
Somatic	GPA	Across	-0.06	0.01	–	–	-0.01	0.01	-0.09	0.01
Mental	Mental	Within	0.14	0.02	0.11	0.02	0.10	0.02	0.25	0.01
Mental	Mental	Across	0.13	0.02	0.08	0.02	0.07	0.02	0.16	0.02
Mental	Somatic	Across	0.03	0.02	0.02	0.02	0.01	0.02	0.05	0.01
Somatic	Mental	Across	0.03	0.02	0.02	0.02	0.01	0.02	0.05	0.01
Somatic	Somatic	Within	0.04	0.01	0.04	0.01	0.03	0.01	0.06	0.01
Somatic	Somatic	Across	0.01	0.01	0.01	0.01	0.01	0.01	0.02	0.01

Note: GPA=Grade point average; EA=educational attainment.

Table 3. Correlations between relatives in educational outcomes and 10 mental and 10 somatic health conditions 10 to 5 years before a couple had their first child, including 95% confidence intervals, along with tests of deviations from direct assortment. Adjusted for sex and year of birth.

Variable	r(partner)	r(sibling)	r(inlaw)	Inlaw inflation factor (IIF)*	Deviation from direct assortment, p-value**
Educational attainment	0.48 [0.47, 0.48]	0.40 [0.40, 0.40]	0.29 [0.28, 0.29]	1.50	<1.00e-99
Grade point average	0.42 [0.42, 0.43]	0.52 [0.52, 0.53]	0.29 [0.29, 0.30]	1.33	<1.00e-99
Substance use disorders	0.54 [0.51, 0.57]	0.37 [0.34, 0.40]	0.27 [0.23, 0.30]	1.32	0.902
Hyperkinetic disorder	0.24 [0.20, 0.27]	0.43 [0.40, 0.45]	0.10 [0.07, 0.13]	0.97	0.279
Personality disorder	0.21 [0.11, 0.32]	0.18 [0.09, 0.26]	0.10 [0.00, 0.20]	2.70	0.902
Psychotic disorders	0.21 [0.13, 0.28]	0.21 [0.16, 0.26]	0.04 [-0.04, 0.11]	0.84	1.78e-04
Depressive disorder	0.16 [0.15, 0.18]	0.23 [0.21, 0.24]	0.07 [0.06, 0.09]	1.91	0.015
Acute stress reaction	0.11 [0.09, 0.13]	0.25 [0.24, 0.27]	0.05 [0.04, 0.07]	1.93	0.112
Sleep disturbance	0.11 [0.08, 0.13]	0.15 [0.13, 0.17]	0.04 [0.02, 0.06]	2.34	0.279
Anxiety disorder	0.11 [0.07, 0.14]	0.20 [0.17, 0.22]	0.04 [0.01, 0.07]	1.85	0.235
Alcohol use disorders	0.10 [0.06, 0.15]	0.14 [0.10, 0.18]	0.05 [0.00, 0.10]	3.43	0.554
Phobia/compulsive disorder	0.09 [0.03, 0.15]	0.13 [0.09, 0.17]	0.03 [-0.02, 0.08]	2.64	1.60e-09
Neck/back symptom	0.08 [0.07, 0.09]	0.13 [0.12, 0.14]	0.05 [0.04, 0.06]	4.34	1.68e-04
Injury musculoskeletal	0.08 [0.06, 0.09]	0.13 [0.12, 0.15]	0.05 [0.03, 0.06]	4.61	0.033
Fractures	0.07 [0.05, 0.09]	0.09 [0.07, 0.11]	0.03 [0.01, 0.05]	4.61	0.902
Naevus/mole	0.06 [0.04, 0.07]	0.14 [0.13, 0.16]	0.01 [-0.01, 0.02]	1.11	0.235
Acne	0.04 [0.02, 0.07]	0.21 [0.20, 0.23]	0.02 [0.00, 0.04]	2.66	0.162
Laceration/cut	0.04 [0.02, 0.06]	0.07 [0.06, 0.09]	0.02 [0.00, 0.03]	5.76	0.003
Headaches	0.04 [0.02, 0.06]	0.11 [0.10, 0.13]	0.03 [0.01, 0.04]	5.90	0.003
Abdominal pain	0.03 [0.02, 0.05]	0.10 [0.09, 0.12]	0.02 [0.01, 0.04]	6.92	0.235

Asthma	0.02 [0.00, 0.04]	0.23 [0.21, 0.24]	0.02 [-0.00, 0.04]	3.92	0.235
Allergic rhinitis	0.02 [0.00, 0.04]	0.19 [0.17, 0.20]	0.01 [-0.00, 0.03]	3.79	0.166

Notes: * IIF is expected to equal 1.00 under direct assortment. Deviations from 1.00 can be due to indirect assortment and social stratification, whereas we deal with convergence by design. ** The p-value arises from comparing a constrained model, where in-law correlation is the product of partner and sibling correlations, to an unconstrained model with independent estimates for each relationship type. A low p-value signifies a poor fit for direct assortment. The p-values are adjusted for false discovery rate using the Benjamini-Hochberg method.

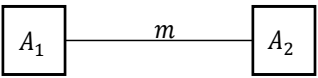
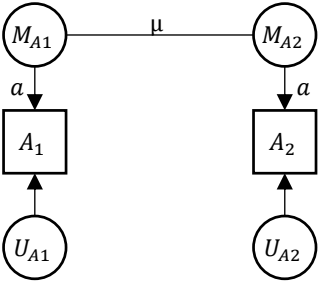
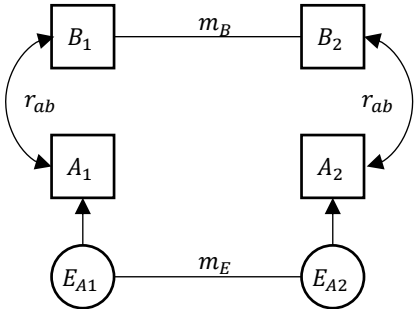
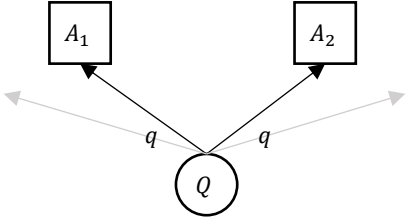
<p>A) Direct assortment</p> 	<p>Direct assortment, also referred to as primary phenotypic assortment, refers to partner similarity (m) due to selection conditional on the observed trait. In this paper, we test for deviations from direct assortment.</p>
<p>B) Indirect assortment based on unknown trait</p> 	<p>Indirect assortment, also referred to as secondary assortment, refers to the situation that partners resemble each other in a focal trait (A) due to assortment in correlated traits. The identity of the correlated traits may or may not be known to the researcher. When it is not known, it may be treated as a latent variable, and its role be deduced from correlational systems. Assortment may take place directly on an unidentified or composite phenotype M_A, but the researcher only observes A. When the assorted phenotype is unknown, variance in a trait can be separated into mated (M_A) and non-mated (U) variance, and the association between M_A and A can be estimated. This requires additional information, such as data on siblings-in-law or co-siblings-in-law. If measurement error is not taken care of, assortment on a phenotype measured with error is indistinguishable from indirect assortment based on an unknown trait. For example, assortment may be direct for depression, but indirect for a low-quality screening instrument. In this paper, indirect assortment is one of two possible explanations of deviations from direct assortment.</p>
<p>C) Indirect assortment based on known trait</p> 	<p>With information on traits correlated with the focal trait, the degree of indirect assortment can be explicitly modelled. In the depiction, assortment on trait A is thought to be secondary to assortment on trait B. The assignment of traits as A and B depends on theory, as the model cannot statistically distinguish between them. For example, partners may be similar in their level of depression due to assortment on neuroticism. The residual mating (m_E) is an upper bound estimate of direct assortment because indirect assortment may also take place on additional traits. In this paper, we test to what degree similarity in health can be secondary to assortment on education.</p>
<p>D) Social stratification</p> 	<p>Social stratification (Q) refers to partner selection taking place within constrained sections of the population. For example, regions could have varying levels of educational attainment, without the education itself influencing partner choice. This is the non-genetic equivalent to population stratification and is one of the meanings of the term “social homogamy” in the literature. In this paper, social stratification is one of two possible explanations of deviations from direct assortment.</p>

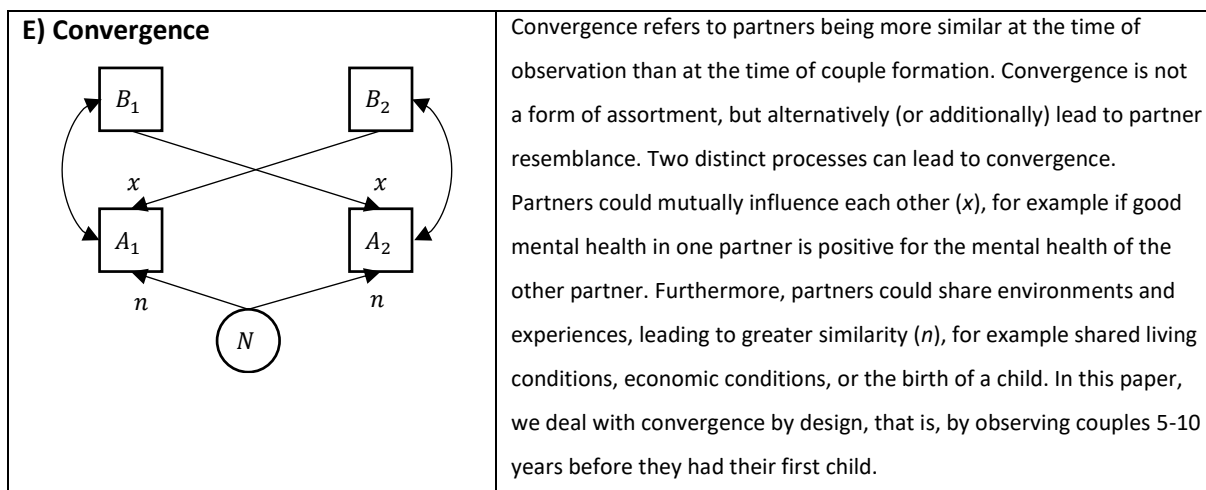

Figure 1. Conceptual representations of mechanisms of similarity between partner 1 and 2 in trait

A. Several mechanisms could co-exist, and the list does not include complex multivariate assortment.

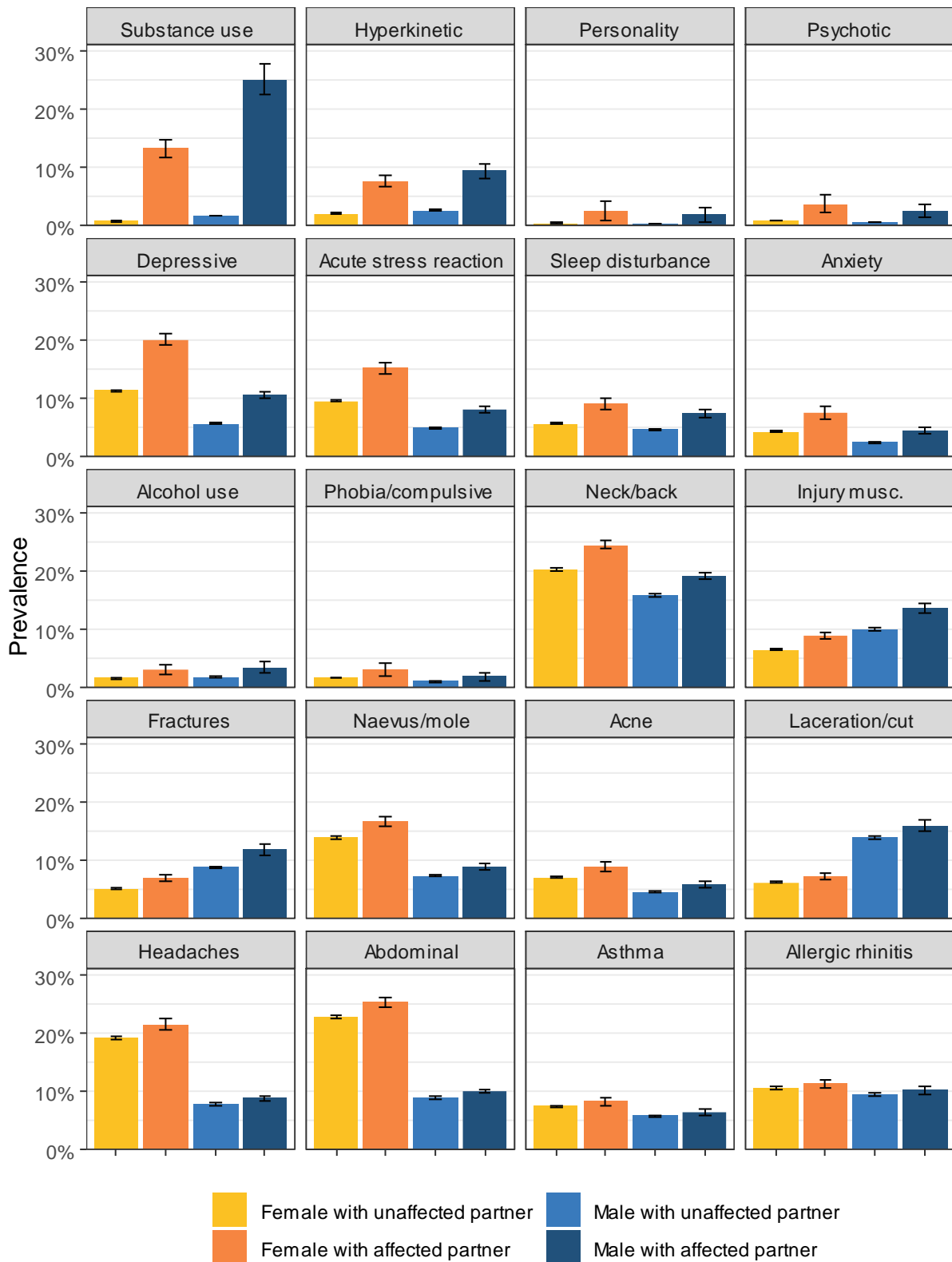

Figure 2. Prevalence of 10 mental and 10 somatic health conditions among males and females with unaffected and affected partners, 10 to 5 years before a couple had their first child. Including 95% confidence intervals.

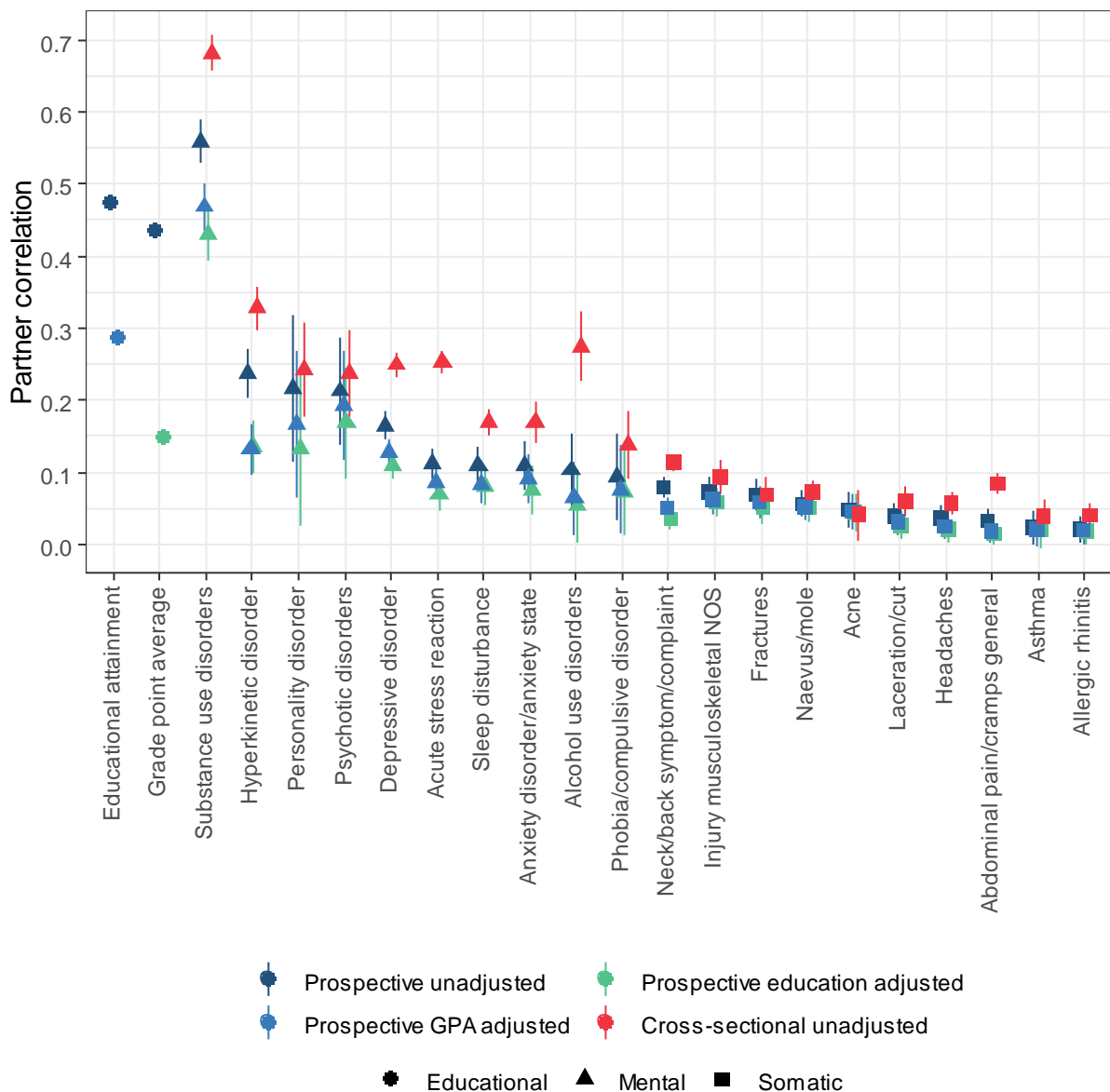

Figure 3. Correlations between female and male partners for educational outcomes and 10 mental health and 10 somatic health phenotypes 10 to 5 years before they had their first child and cross-sectionally in 2015-2019.

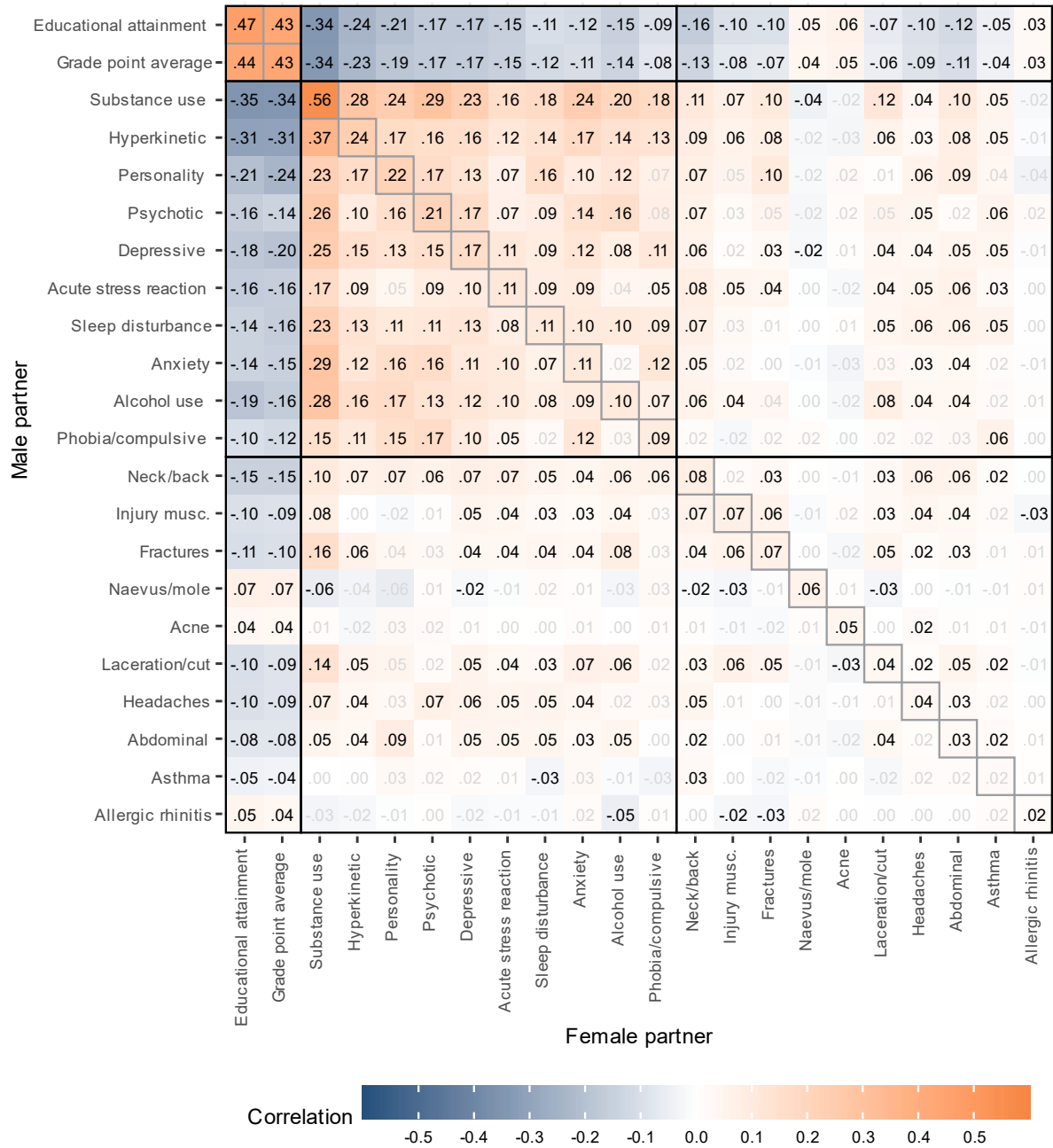

Figure 4. Within and across-trait partner correlations for educational outcomes, 10 mental health conditions, and 10 somatic health conditions, 10 to 5 years before first child. Adjusted for age. Correlations shown in black have p-values < 0.05 after adjusting for the false discovery rate.

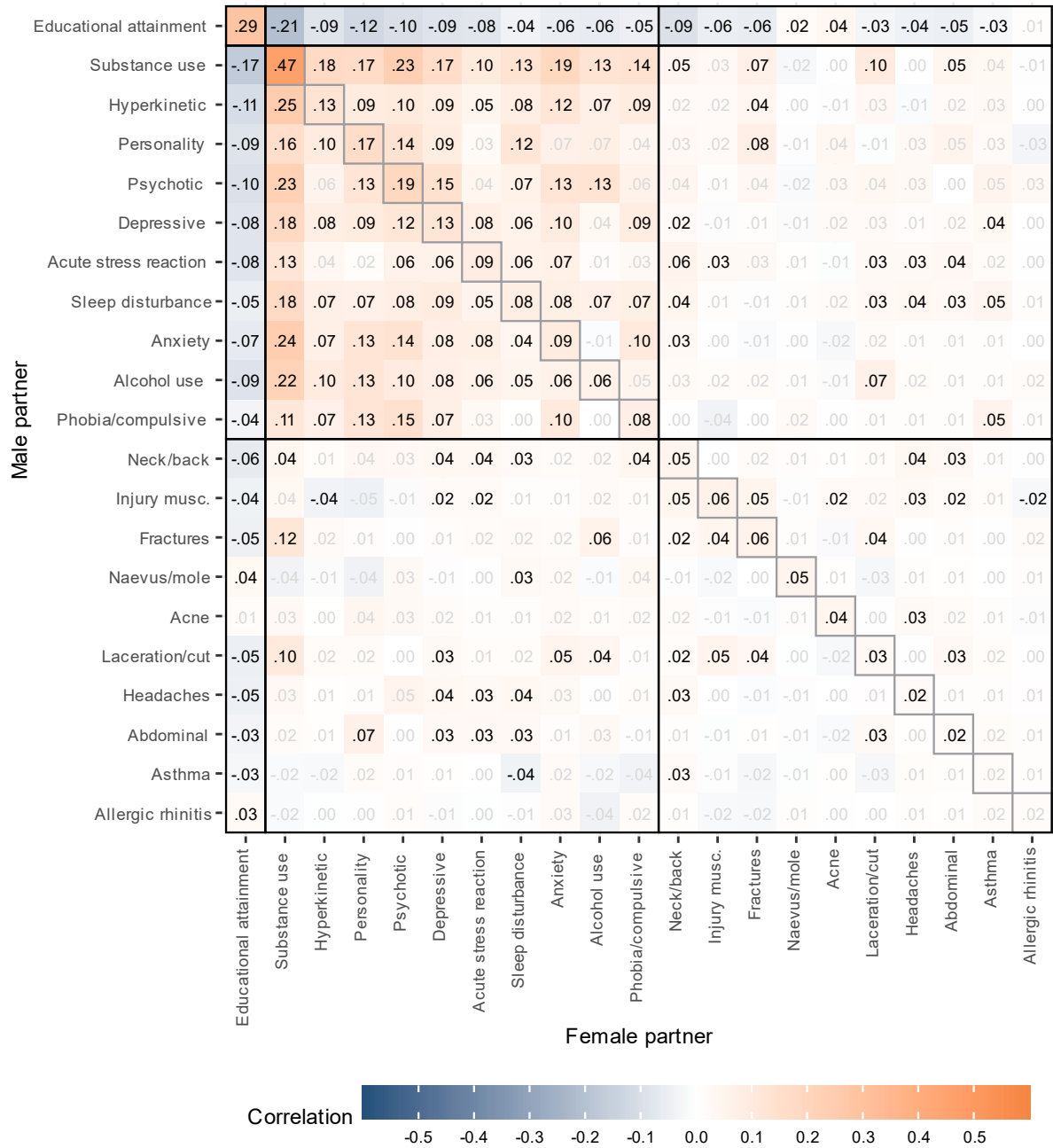

Figure 5. Within and across-trait partner correlations for 10 mental health conditions, and 10 somatic health conditions, 10 to 5 years before first child. Adjusted for age and grade point average. Correlations shown in black have p-values < 0.05 after adjusting for the false discovery rate.

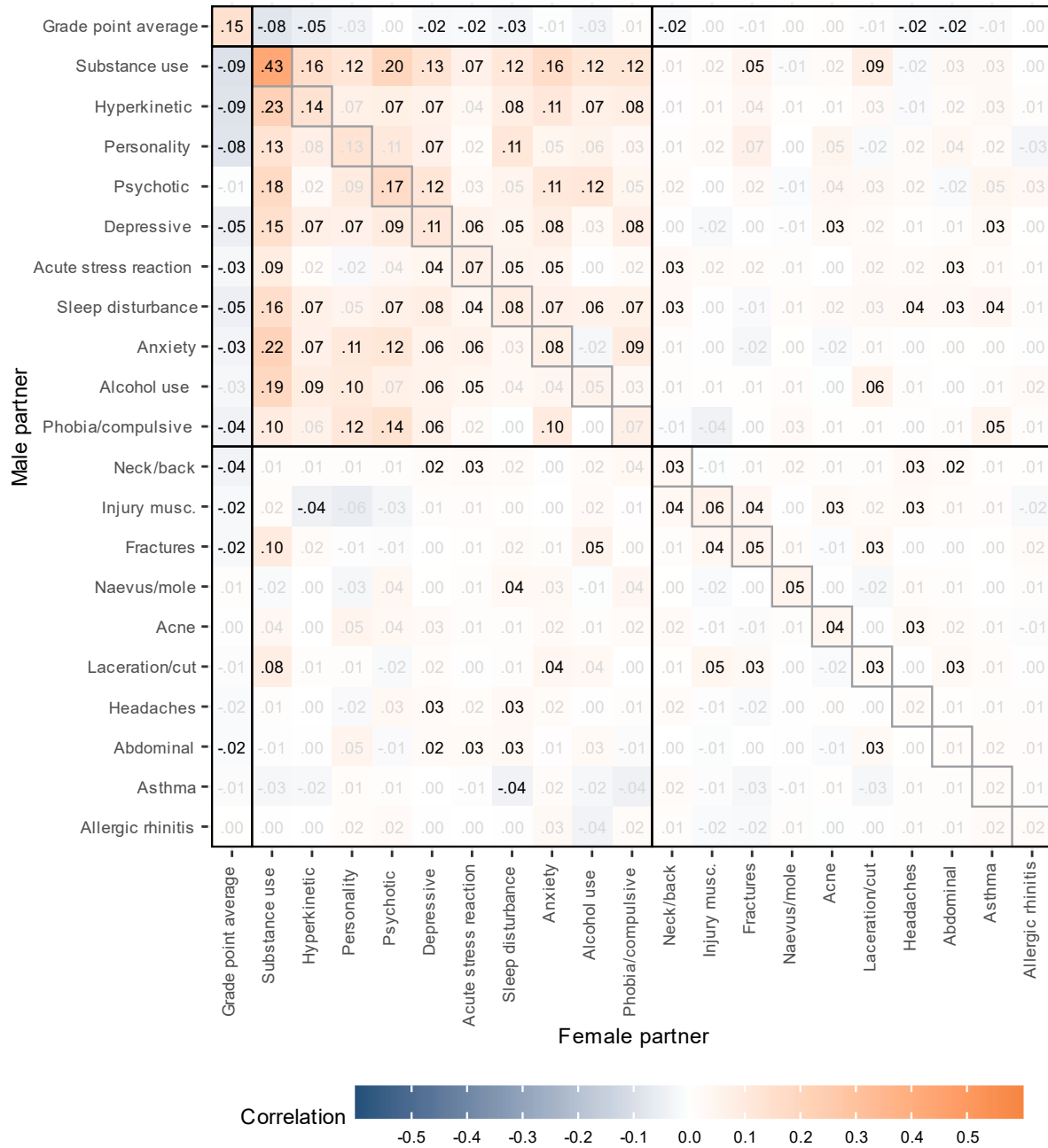

Figure 6. Within and across-trait partner correlations for 10 mental health conditions, and 10 somatic health conditions, 10 to 5 years before first child. Adjusted for age and educational attainment. Correlations shown in black have p-values < 0.05 after adjusting for the false discovery rate.

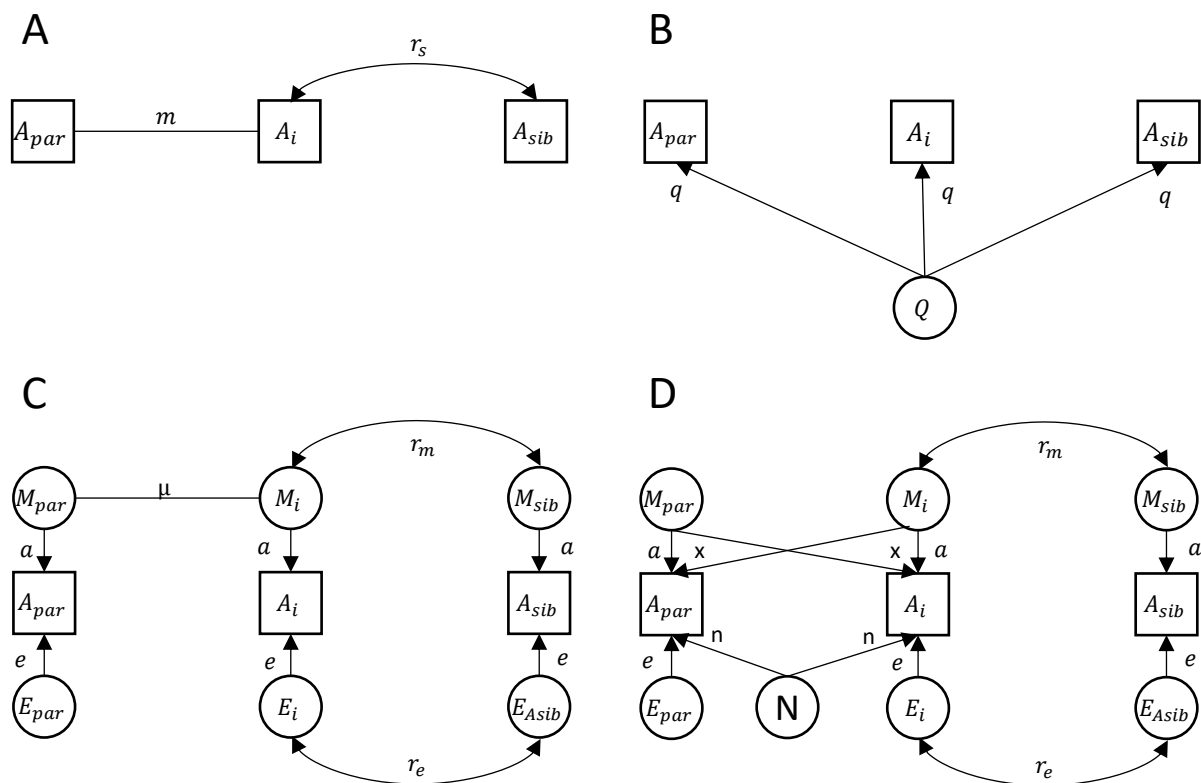

Figure 7. Four mechanisms of partner similarity and expected correlations between partners, siblings, and siblings-in-law. A_i is the index person's phenotype, A_{par} is their partner's phenotype, and A_{sib} is their sibling's phenotype. Panel A illustrates direct assortment. Panel B illustrates social stratification. Panel C illustrates indirect assortment. Panel D illustrates convergence by shared environments (N) or mutual influences (x). Unit variance can be assumed for simplicity.