

1 **Optimization of nutritional strategies using a mechanistic computational model in**
2 **prediabetes: Application to the J-DOIT1 study data**

3

4 Julia H. Chen^{1, #a}, Momoko Fukasawa², Naoki Sakane^{3*}, Akiko Suganuma³, Hideshi Kuzuya³,
5 Shikhar Pandey¹, Paul D'Alessandro¹, Sai Phanindra Venkatapurapu¹, Gaurav Dwivedi¹

6

7 ¹ PricewaterhouseCoopers LLP, 301 Grant Street, Suite 4500, Pittsburgh, PA, 15219, USA

8 ² PwC Consulting LLC, Otemachi One Tower, 1-2-1 Otemachi, Chiyoda-ku, Tokyo, 100-0004,
9 Japan

10 ³ Division of Preventive Medicine, Clinical Research Institute, National Hospital Organization
11 Kyoto Medical Center

12 ^{#a} Current Address: COTA Healthcare, 609 Greenwich St, 4th Floor
13 New York, NY 10014

14

15 *** Corresponding author**

16 E-mail: nsakane@gf6.so-net.ne.jp

17

18

19 **Abstract**

20 Lifestyle interventions have been shown to prevent or delay the onset of diabetes; however,
21 inter-individual variability in responses to such interventions makes lifestyle recommendations
22 challenging. We analyzed the Japan Diabetes Outcome Intervention Trial-1 (J-DOIT1) study
23 data using a previously published mechanistic simulation model of type 2 diabetes onset and
24 progression to understand the causes of inter-individual variability and to optimize dietary
25 intervention strategies at an individual level. J-DOIT1, a large-scale lifestyle randomized
26 intervention study, involved 2607 subjects with a 4.2-year median follow-up period. We selected
27 112 individuals from the J-DOIT1 study and calibrated the mechanistic model to each
28 participant's body weight and HbA1c time courses. We evaluated the relationship of
29 physiological (e.g., insulin sensitivity) and lifestyle (e.g., dietary intake) parameters with
30 variability in outcome. Finally, we used simulation analyses to predict individually optimized
31 diets for weight reduction. The model predicted individual body weight and HbA1c time courses
32 with a mean (\pm SD) prediction error of 1.0 kg (\pm 1.2) and 0.14% (\pm 0.18), respectively. Individuals
33 with the most and least improved biomarkers showed no significant differences in model-
34 estimated energy balance. A wide range of weight changes was observed for similar model-
35 estimated caloric changes, indicating that caloric balance alone may not be a good predictor of
36 body weight. The model suggests that a set of optimal diets exists to achieve a defined weight
37 reduction, and this set of diets is unique to each individual. Our diabetes model can simulate
38 changes in body weight and glycemic control as a result of lifestyle interventions. Moreover, this
39 model could help dietitians and physicians to optimize personalized nutritional strategies
40 according to their patients' goals.

41

42 **Introduction**

43 In the National Diabetes Statistics Report 2020 [1] from the Centers for Disease Control and
44 Prevention (CDC), it was estimated that about 34.2 million people (~10.5% of the US
45 population) are diabetic, accounting for \$237 billion in direct medical expenses and \$90 billion
46 in indirect medical costs. Globally, diabetes is now considered an epidemic, affecting more than
47 420 million individuals (~6% of the world's population) [2] and can lead to various
48 complications [3]. Although lifestyle factors, such as diet composition, exercise, and sleep, play
49 an important role in type 2 diabetes (T2D) development [4–6], the response to similar lifestyle
50 changes varies dramatically among individuals [7]. This inter-individual variability could be due
51 to pathophysiological differences among individuals [8], differences in the physiological
52 response to dietary or exercise intervention [9], and other factors [7]. Therefore, it is desirable to
53 develop a framework for designing individualized strategies to achieve defined health goals
54 targeted toward preventing or delaying the onset of diabetes. However, a limited understanding
55 of the causes of inter-individual variability makes it challenging to design individualized
56 interventions, e.g., diet plans, for diabetes prevention.

57
58 Precision nutrition aims to prevent and manage chronic diseases by tailoring dietary
59 interventions or recommendations considering the individual's genetic background, metabolic
60 profile, gut microbiome, and environmental exposure. Currently, the field of precision nutrition
61 is faced with challenges such as the high cost of genomics and metabolomics technologies, and
62 lack robust and reproducible results in studies on precision nutrition [10,11]. In contrast to
63 precision nutrition, there are general strategies that do no attempt to individualize dietary
64 recommendations, such as low-carbohydrate or low-fat diets. Several studies have shown the

65 effectiveness of both low-fat and low-carbohydrate diets for weight control and reduction of
66 cardiovascular risk [12–16]. The US Diabetes Prevention Program (DPP) [4] and Finnish
67 Diabetes Prevention Study (DPS) [5] on lifestyle modifications (low-fat diets, 5-7% weight loss,
68 and exercise habits) have demonstrated a reduction in the burden of T2D by up to 58% [4]. A
69 meta-analysis [17] of data from 11 randomized controlled studies (1369 participants) revealed
70 that a low-carbohydrate diet can aid in weight reduction [18]. Moreover, a low-carbohydrate diet
71 was also found to be more effective in glycemic control compared to a low-fat diet in patients
72 with T2D [19].

73
74 While generalized dietary strategies such as low-fat and low-carbohydrate diets have been
75 successful to varying degrees in various contexts, it is unclear whether and which approach may
76 be successful for a specific individual. Advances in precision nutrition are promising but still
77 under development and may not be cost-effective [10]. To address the need for individualized
78 dietary recommendations, we explore the use of a computational simulation modeling tool in this
79 work.

80
81 We previously developed a computational simulation model [20] of macronutrient metabolism
82 and T2D onset and progression and tested it using data from DPP. The impact of lifestyle
83 changes on endpoints including body weight and HbA1c were predicted at the individual level
84 over a period of 3 years for 315 subjects from the DPP study. The mean prediction error for
85 individual-level body weight and HbA1c changes over the three-year period was approximately
86 5% each. This suggests that the model can be used to predict and optimize individual-level
87 responses to lifestyle changes. To our knowledge, currently there are no studies on the

88 optimization of dietary strategies for preventing T2D using simulation modeling based on
89 physiological principles.

90
91 The Japan Diabetes Outcome Intervention Trial-1 (J-DOIT1), a nationwide pragmatic cluster-
92 randomized controlled trial, showed that participants who received telephone calls more
93 frequently had a significantly reduced risk (41%) of T2D development [21,22]. Herein, using the
94 simulation model, we analyzed data from J-DOIT1 [22] to evaluate factors affecting inter-
95 individual variability in response to diet change, including endogenous (physiological
96 characteristics) and exogenous (e.g., macronutrient intake) factors. The model adequately
97 described individual-level body weight and HbA1c dynamics over time. We also demonstrate
98 how the simulation approach may be used to optimize diet therapy for individuals to achieve
99 specific health goals.

100

101 **Methods**

102 **Simulation model**

103 A previously developed computational simulation model of T2D was used [20]. This
104 computational simulation model of T2D, referred to as the “model” henceforth, is based on the
105 physiological mechanisms underlying the onset and progression of T2D. Important physiological
106 (endogenous) and lifestyle (exogenous) factors involved in T2D are represented in the model.
107 Exogenous factors influencing T2D are represented through dietary intake of macronutrients,
108 i.e., carbohydrates, fats, and proteins, as well as energy expenditure through physical activity.
109 Endogenous or physiological drivers of T2D are represented mechanistically in the model
110 through physiological processes occurring at the cellular, tissue, and whole-body levels.

111
112 At a high level, the model mathematically represents the dynamics of dietary intake of
113 carbohydrates, fats, and proteins, their breakdown and transportation into major tissue
114 compartments through the bloodstream, and the interconversion of metabolic species into stored
115 and active forms (**Error! Reference source not found.**). A module representing the pancreas
116 regulates insulin secretion into the bloodstream. Cellular processes modulating the activation of
117 insulin receptors by insulin drive the development of insulin resistance, which in turn controls
118 several processes, including glucose uptake by tissues. Oxidation of macronutrients generates
119 ATP, which provides energy for basal metabolism and physical activity. Changes in caloric
120 intake, macronutrient composition, and/or physical activity levels have a cascading impact on all
121 components of the model, leading to changes in key outputs, such as body weight, plasma
122 glucose, and HbA1c.
123 Details regarding the development and validation of the model have been described previously
124 [20]. For the analysis presented here, the model described in the original publication was used.

125

126 **Digital twins**

127 The computational simulation model comprises several numerical parameters that can be
128 adjusted to fit model outputs, such as body weight and HbA1c trends over time, to the observed
129 data of a specific individual. A model that has been calibrated to represent the historical data of a
130 specific individual can be considered a “digital twin” of the individual. The digital twin can be
131 used to simulate experiments with various lifestyle modifications quickly and safely in a virtual
132 *in silico* environment. The model’s ability to use digital twins to predict body weight and HbA1c
133 was previously tested using individual-level data from DPP [4,20]. The concept of digital twins

134 was applied in the work presented here. Digital twins were created for individuals selected from
135 the J-DOIT1 study by calibrating instances of the model using a previously described method
136 [20]. The digital twins were then used to simulate various scenarios to understand and analyze
137 the variability in individual responses to interventions.

138

139 **J-DOIT1 study**

140 The Japan Diabetes Outcome Intervention Trial-1 (J-DOIT1) is a pragmatic, cluster-randomized
141 controlled trial conducted in Japan. The trial investigated the impact of lifestyle coaching
142 delivered through telephone calls on T2D development in high-risk individuals in a primary
143 healthcare setting [21]. A total of 2607 individuals (1240 in the intervention arm and 1367 in the
144 control (placebo) arm) completed the study with a median follow-up period of 4.2 years [22].
145 Participants in the intervention arm received lifestyle support telephone calls from healthcare
146 providers over a 1-year period. The intervention arm was further divided into three lifestyle
147 support centers designated as centers A, B, and C. During the 1-year period for which telephone-
148 delivered lifestyle support was provided, participants in centers A, B, and C received 3, 6, and 10
149 support calls, respectively. Thus, centers A, B, and C can be considered as low-, medium-, and
150 high-support call frequency groups, respectively. The control arm did not receive any support
151 through telephone but received periodic newsletters on diabetes and diabetes prevention. The
152 participants were followed-up annually. The onset of T2D status was assessed as the primary
153 outcome, and the other outcomes included body weight and HbA1c.

154 **Patient recruitment**

155 Using the 2006 health checkup data, candidates who met the inclusion criteria were identified in
156 each group. Inclusion criteria included an age of 20-65 years and impaired fasting glucose (IFG),

157 defined as a fasting plasma glucose concentration (FPG) of 100-125 mg/dL (5.6-6.9 mmol/L).
158 Exclusion criteria included diagnosed diabetes, a history of taking anti-diabetic agents, and a
159 HbA1c of $\geq 6.5\%$ [13]. Women with a history of gestational diabetes could be enrolled. Physical
160 or medical conditions that do not allow exercise, pregnancy or possible pregnancy, type 1
161 diabetes mellitus, liver cirrhosis or chronic viral hepatitis, and the use of a cardiac pacemaker
162 were also exclusion criteria. The study participants were registered from March 31, 2007, to
163 January 25, 2008. The follow-up of the participants ended in March 2011.

164 **Selection of the analysis dataset**

165 A total of 112 unique J-DOIT study participants were selected for the individual-level analysis
166 using the following algorithm (**Error! Reference source not found.**). For each subject in the J-
167 DOIT1 dataset, the percentage change in the body weight and HbA1c level from baseline to the
168 end of the intervention was calculated. The degree of response for each subject was defined as
169 the sum of the percentage decrease in the body weight and HbA1c. Individuals with the largest
170 collective decrease in the body weight and HbA1c were considered as the “best responders”
171 while those with the least decrease or greatest increase were considered as the “worst
172 responders.” Using this definition, 29 best responders were selected from the intervention arm,
173 with 10 each drawn from the low- and high-support call frequency groups, and 9 from the
174 medium-support call frequency group (corresponding to centers A, C, and B, respectively, as
175 described above). Similarly, 30 worst responders were selected from the intervention arm, with
176 10 each from the low-, medium-, and high-support call frequency groups. Thus, 59 subjects were
177 selected from the intervention arm with nearly equal representation of the best and worst
178 responders from all three call frequency groups.

179

180 Subsequently, a baseline-matched subject from the control arm was identified for each of the 59
181 subjects selected from the intervention arm. The method used to identify baseline-matched
182 subjects is described next. Sex, height, baseline age, baseline body weight, and baseline HbA1c
183 levels of each subject from the intervention arm were selected as the reference values. Matched
184 subjects in the control arm with the same sex, height within ± 3 cm, baseline age within ± 2 years,
185 baseline body weight within ± 4 kg, and baseline HbA1c within $\pm 0.3\%$ of the reference value
186 were selected. Of the subjects from the control arm that matched these criteria, the subject with
187 the smallest difference in body weight and HbA1c level was selected as the baseline-matched
188 pair of the intervention subject. If a matched subject from the control arm could not be found for
189 a subject from the intervention arm, the intervention arm subject was dropped and another
190 intervention subject was selected.

191
192 Using these criteria, 53 unique subjects were selected from the control arm. The number of
193 unique subjects selected from the control arm was less than 59 because 6 control subjects were
194 baseline-matched to 2 intervention subjects each. The 53 matched subjects from the control arm
195 were used as the training dataset, and the other 59 from the intervention arm were used to test the
196 model predictions. Further details of the training and test processes are described below.

197 12 unique subjects were selected for individual-level analysis. 59 subjects were selected from the
198 intervention arm of J-DOIT1 with a nearly equal distribution over three call frequency groups
199 and two response categories within each call frequency group. 53 subjects from the control arm
200 were found to be the best baseline-matched pairs of the 59 subjects from the intervention arm.

201

202 **Model calibration and testing**

203 The model consists of two types of parameters: 1) physiological parameters or parameters
204 representing endogenous processes that are inherent to the individual and do not change over the
205 course of the simulation; and 2) lifestyle parameters, which can change dynamically over time
206 because of interventions.

207

208 **Calibration of the training dataset**

209 For the training dataset, a subset of physiological parameters was calibrated in addition to
210 lifestyle parameters (Table 1) to fit the model's predicted body weight and HbA1c levels to each
211 subject's measured body weight and HbA1c time course over the duration of the J-DOIT1 study.
212 While the physiological parameters were constant for an individual by design, step changes in
213 lifestyle were allowed at discrete time points over the duration of the simulation. The set of
214 physiological and lifestyle parameters that resulted in the best achievable fit to the measured
215 body weight and HbA1c time course of an individual was accepted as the parameter set for that
216 individual. As a result of this process, each subject from the training set had a unique
217 combination of physiological and lifestyle parameters that defined the digital twin of that subject.

218

219 Table 1. Model parameters calibrated to fit individual subject time-course data.

Category	Parameter fit to individual subject	Parameter symbol ³
Physiology parameters ¹	Basal carbohydrate intake requirement to maintain steady state	CI_0
	body weight	
	Basal fat intake requirement to maintain steady state body weight	FI_0

	Maximal HbA1c concentration	C_{hba1c}^{BLD}
	Initial HbA1c concentration	$C_{hba1c}^{BLD}(t = 0)$
	Maximal inhibitory effect of free fatty acids (FFA) on insulin signaling	α_{dep_ffa}
	FFA concentration for half maximal inhibition of insulin signaling	k_{dep_ffa}
	Extent of pancreatic beta cell damage due to glucotoxicity, lipotoxicity, and inflammation	α_{bc,s_ros}
Historical lifestyle parameters ¹	Carbohydrate intake prior to study start	CI
	Fat intake prior to study start	FI
Lifestyle parameters during the study ²	Carbohydrate intake at various time points during the study	CI_1, CI_2, \dots, CI_4
	Fat intake at various time points during the study	FI_1, FI_2, \dots, FI_4
	Change in physical activity at various time points during the study	$\Delta PA_1, \dots, \Delta PA_4$
	Time points at which carbohydrate intake, fat intake, and physical activity change during the study	T_1, T_2, \dots, T_4

220

221 ¹Calibrated only for baseline-matched subjects from the control group, i.e., training dataset.

222 ²Calibrated for all subjects.

223 ³Symbols as used in the original model [20].

224

225 **Calibration of the test dataset**

226 As described above, the training dataset was obtained by baseline-matching the test data. The

227 baseline-matched pairs comprising one subject each from the training and test datasets were of

228 the same age and sex and had similar body weight, height, body mass index, and HbA1c at
229 baseline. Because of this similarity in their baseline attributes, we assumed that the physiological
230 parameters, as well as carbohydrate and fat intake prior to the start of the study were identical for
231 both subjects in a baseline-matched pair. The implication of this assumption is that the
232 physiological parameters of each test subject are predetermined by their corresponding match
233 from the training dataset; any differences in the observed body weight and HbA1c time courses
234 of the pair during the J-DOIT1 study could be explained only by differences in their lifestyles,
235 such as carbohydrate and fat intake and exercise changes during the study. This limits the range
236 of responses that can be achieved for individuals in the test dataset because lifestyle is the only
237 variable input to the model and serves as a mechanism to test the model's ability to forecast
238 individual responses. For the test dataset, only step changes in the category "Lifestyle parameters
239 during the study" (Table 1) were allowed. The time points at which these step changes in
240 lifestyle were introduced in the simulation were determined empirically based on trends in body
241 weight and HbA1c. Whenever a previously decreasing trend in either body weight or HbA1c was
242 followed by an increasing trend or vice-versa, a lifestyle change was introduced, assuming that
243 such changes in body weight or HbA1c could only be driven by lifestyle factors. A maximum of
244 four such discrete lifestyle changes were permitted for each subject over the approximately 4-
245 year follow-up. Changes in lifestyle parameters were calibrated for each test subject to determine
246 the best fit to individual time courses of body weight and duration over the duration of the J-
247 DOIT1 study.

248
249 Parameter calibrations were performed using the differential evolution algorithm [23] and the
250 objective function to be minimized was the sum of the squared errors over all time points for

251 body weight and HbA1c. For calibration, each data point was assumed to have an inherent
252 measurement error, and the objective function was designed to consider this error. Body weight
253 was assumed to carry a measurement error of ± 1 kg based on previous studies on imprecision in
254 the measurement of body weight using weighing scales [24,25]. HbA1c was assumed to have a
255 measurement error of ± 0.15 percentage points, which is approximately 3% of the median HbA1c
256 value of 5.5% across all data points in this analysis. A 3% error is well within the $\pm 5\%$
257 measurement error considered acceptable by the National Glycohemoglobin Standardization
258 Program (NGSP) [26]. Based on a study of Japanese individuals, the measurement error for
259 HbA1c was estimated to be 0.17 percentage points [27].

260

261 The following objective function was used for parameter estimation for each subject:

$$262 \quad \Phi(\theta) = \sum_i \sum_j \frac{(y_{ij}(\theta) - x_{ij})^2}{e_i^2}$$

263 where θ represents the model parameter vector, i is either body weight or HbA1c and j
264 represents all the time points at which biomarker i is measured for the subject. e_i is the
265 measurement error associated with biomarker i , such that $e_{body\ weight} = 1\ kg$ and e_{HbA1c}
266 $= 0.15\%$.

267

268 **Simulations**

269 To test the effects of dietary changes and determine the optimal diet, simulations were performed
270 using the calibrated digital twins of the study subjects. Starting from the baseline age (age at the
271 start of J-DOIT1) of a digital twin, a random step change in carbohydrate and fat intake was
272 introduced. Keeping all other parameters constant, the body weight and HbA1c time-courses

273 were simulated with diet change. This process was repeated multiple times for each digital twin
274 using a Monte Carlo approach with macronutrient changes sampled from a uniform random
275 distribution in the range baseline value – 25% to baseline value + 25%. The simulation outputs
276 were recorded and analyzed.

277

278 **Results**

279 **The model successfully captures individual-level dynamics of body** 280 **weight and HbA1c**

281 The model was fit to individual time-courses of body weight and HbA1c by calibrating both
282 physiological and lifestyle parameters (Table 1) for the training dataset and only lifestyle
283 parameters for the test dataset, as described in the Methods section. Results showed that
284 individual-level changes in the body weight and HbA1c over time were captured well by the
285 model for both the training and test datasets (Fig3, **Error! Reference source not found.**
286 Supplementary Fig S1-S6). Visual comparison of the predicted values with the measured values
287 across all time points for all subjects indicated that the model performs well at predicting the
288 measured values (Supplementary Fig S7). The prediction error (mean [\pm SD]) across all data
289 points in the training dataset for body weight was 0.7 kg (\pm 0.8) and for HbA1c it was 0.08%
290 (\pm 0.08). In terms of percentage error (mean [\pm SD]), body weight of subjects in the test dataset
291 was predicted with an error of 1.1% (\pm 1.0) and HbA1c with an error of 1.4% (\pm 1.4) relative to
292 the actual measurement (Table 2).

293
294 Panels on the left-hand side represent a subject from the training data set. Panels on the right-
295 hand side show the baseline-matched subject from the test data set. The test subject is from the
296 high call frequency group and was classified in the best responder category. The error bars
297 around the measured values are assumed measurement errors, ± 1 kg for body weight and ± 0.15
298 points for HbA1c, as described under model calibration in the Methods section

299
300 The prediction error (mean $[\pm SD]$) across all data points in the test dataset for body weight was
301 1.3 kg (± 1.4), and for HbA1c it was 0.18% (± 0.23). In terms of percentage error, body weight
302 was predicted for the test dataset with an error of 1.8% (± 1.9) and HbA1c with an error of 3.4%
303 (± 4.2) relative to the measured value (Table 2).

304
305 **Table 2. Model prediction errors.** Prediction errors are shown after grouping subjects using
306 various criteria.

Group	Number of unique subjects	Biomarker	Absolute prediction error Mean ($\pm SD$)	Percentage prediction error Mean ($\pm SD$) [% of measured]
All subjects	112	Body weight	1.0 kg (± 1.2)	1.5 (± 1.6)
		HbA1c	0.14% (± 0.18)	2.5 (± 3.4)
Control (Training data)	53	Body weight	0.7 kg (± 0.8)	1.1 (± 1.0)
		HbA1c	0.08% (± 0.08)	1.4 (± 1.4)
Intervention	59	Body weight	1.3 kg (± 1.4)	1.8 (± 1.9)

(Training data)		HbA1c	0.18% (± 0.23)	3.4 (± 4.2)
Best responders	29	Body weight	1.6 kg (± 1.8)	2.4 (± 2.3)
		HbA1c	0.20% (± 0.26)	3.6 (± 4.9)
Worst responders	30	Body weight	1.0 kg (± 0.9)	1.4 (± 1.2)
		HbA1c	0.17% (± 0.19)	3.1 (± 3.4)

307

308

309 **Changes in caloric balance alone do not fully explain the variability**

310 **in individual response**

311 After calibration and testing against individual time-course data, the model was used to estimate
312 the likely caloric change per individual that led to the observed change in body weight.

313 Calibrated digital twins were used to estimate the caloric change for each individual due to
314 modifications in diet and exercise during the period between baseline and first follow-up in the
315 intervention period of the J-DOIT1 study (median duration 1 year). The total caloric change
316 (decrease or increase) was defined as the sum of changes in caloric intake due to diet change and
317 caloric expenditure due to exercise. Changes in daily calories from baseline to the first post-
318 baseline follow-up were estimated for each individual using the calibrated model parameters.

319 The measured change in body weight during the same interval (baseline to the first follow-up)
320 was also calculated. The model-estimated caloric change versus the observed weight change
321 from baseline to the first follow-up is shown in Fig4**Error! Reference source not found.** The
322 measured change in body weight generally increased with the model-predicted increase in caloric
323 intake, with a Pearson correlation coefficient of 0.82 (**Error! Reference source not found.**).

324 The model predicted that similar caloric changes could lead to a wide range of responses in terms

325 of body weight changes across individuals, as indicated by the spread of the points along the y-
326 axis in **Error! Reference source not found.** When a linear regression model was fit to the data
327 (solid gray line in **Error! Reference source not found.**), the residual error ranged from -4.6 kg
328 to +7.0 kg with a residual standard error of 2.5 kg, indicating a relatively wide spread of body
329 weights around the line of best fit. This suggests that changes in calorie intake alone may not be
330 sufficient to predict individual-level changes in body weight. Similar trends were observed for
331 HbA1c levels (Supplementary Fig S8).

332 The measured change in body weight from baseline to the first follow-up during the J-DOIT1
333 intervention (median duration 1 year) is plotted against model-estimated change in calories per
334 day due to both diet and exercise changes averaged over the same period for subjects in the
335 intervention arm. The gray number in each quadrant is the fraction of data points in that
336 quadrant. The data points fit a linear regression model (solid gray line) with $r^2 = 0.67$ and a
337 residual standard error of 2.5 kg, indicating a relatively widespread around the line of best fit.
338 Best and worst responders were defined based on the total percent change in body weight and
339 HbA1c one year after the end of the J-DOIT1 intervention.

340

341

342 We also explored the question of whether the degree of response (change in body weight and
343 HbA1c) could be related to endogenous characteristics (physiology parameters defined in Table
344 1) of subjects. None of the calibrated physiology parameters, either alone or in linear
345 combinations, were found to be correlated with changes in body weight or HbA1c.

346

347 **Diet therapy is predicted to have maximal effectiveness when** 348 **optimized individually**

349 Simulations were performed to determine the “optimal” diet for achieving a 5-7% reduction in
350 body weight over a period corresponding to the duration between baseline and 1-year post-
351 intervention. Digital twins of the J-DOIT1 study subjects from the test dataset (N = 59) were
352 simulated with various random modifications to their carbohydrate, fat, and protein intake. Each
353 macronutrient was sampled from a uniform distribution within $\pm 25\%$ of its default baseline value
354 for the digital twin. Diets that led to a 5-7% reduction in body weight were selected as optimal
355 diets. Using this approach, optimal diets could be identified for 48 of the 59 subjects; the
356 remaining 11 subjects probably needed diet changes beyond the $\pm 25\%$ range simulated. Of the
357 48 subjects for whom optimal diets could be identified, only a single diet change (24% reduction
358 in carbohydrate and 25% reduction in fat intake) led to a 5-7% reduction in body weight. For all
359 other subjects (N = 47), there was no single optimal diet that led to a 5-7% reduction in body
360 weight; instead, a set of various diet compositions could lead to the target weight reduction (a
361 range of 3 to 668 diet compositions for each subject with a median of 186 diet compositions).
362 Furthermore, this set of diets was unique to each participant. A comparison of distributions of the
363 optimal diets for two subjects is shown as an example in Fig5**Error! Reference source not**
364 **found.**

365
366 The two subjects presented in Fig5**Error! Reference source not found.** show qualitatively
367 different distributions of optimal diet changes. For subject ID Test-041, carbohydrate intake
368 could change over a wide range of approximately -25% to +25% but fat change needed to be
369 more narrowly restricted between approximately -25% to -10%. Contrary to this, for subject ID

370 Test-044, fat change could range between -25% to +25% but carbohydrate change had to be
371 restricted to a narrower range (-25% to -5%). In an alternative interpretation, subject ID Test-041
372 is predicted to be more sensitive to fat change than to carbohydrate change and should more
373 precisely control fat intake to achieve the targeted weight loss. Subject ID Test-044, on the other
374 hand, is predicted to be more sensitive to carbohydrate change; this subject should pay more
375 attention to regulating carbohydrate intake but can be less particular about controlling fat intake.
376 Monte Carlo simulations identified a unique set of “optimal” carbohydrate and fat changes
377 required for each subject that were predicted to lead to a targeted 5-7% reduction in body weight.
378
379 In addition to the 5-7% body weight reduction for subject Test-041(Fig5), an additional target of
380 0.1-0.2 point reduction in HbA1c was added. Applying this additional target led to further
381 refinement of the optimal diets and a subset of the original optimal diets was predicted to
382 simultaneously achieve both targets (Fig6).
383 The subset (pink circles) of optimal diets identified for subject Test-041 (Fig5) to achieve a 5-7%
384 reduction in body weight (gray and pink circles) was predicted to additionally reduce HbA1c by
385 0.1-0.2%.
386

387 **Individuals show differential sensitivity to carbohydrate and fat** 388 **changes**

389 The simulation-based diet optimization results were used to explore whether all subjects could be
390 classified into carbohydrate or fat sensitive categories. After finding the set of optimal diets for
391 each subject using simulations as described above, lines of best fit were obtained for each
392 subject’s (N = 47 subjects with >1 optimal diets) predicted set of optimal diet changes (Fig7).

393 These lines approximate the predicted optimal diet change patterns for each subject and are a
394 reasonable simplification for easy visualization and analysis of the diet patterns. All lines had
395 negative slopes implying that if a subject were to shift to a smaller reduction in carbohydrate
396 intake, it could be compensated by a larger reduction in fat intake, and vice versa. Additionally,
397 the shifts would have to move along the line, so the magnitude of compensation required was
398 different for each subject as determined by the slope of the line.

399

400 For a hypothetical subject whose line of best fit has slope of -1 (angle of -45° with the x-axis), a
401 downward (upward) shift of X% in carbohydrate change could be compensated by a
402 corresponding upward (downward) shift of exactly X% in fat change. Therefore, a subject with a
403 slope of exactly -1 can be considered to be equally sensitive to changes in carbohydrate and fat
404 intake. As the line becomes increasingly horizontal (angle with the x-axis between -45° and 0° ,
405 slope between -1 and 0), the sensitivity regime shifts towards greater sensitivity to fat change
406 because for a nearly horizontal line, fat change must be tightly controlled while carbohydrate
407 change can vary widely. Conversely, as the line becomes more vertical (angle with the x-axis
408 between -90° and -45° , slope < -1), it indicates a greater sensitivity to carbohydrate change.

409 Based on these concepts, individuals were classified as carbohydrate sensitive (slope < -1) or fat
410 sensitive based on the slopes of their lines (slope > -1) (Fig7). A total of 29 (62%) subjects were
411 identified as having a greater sensitivity to fat change and 18 (38%) as being more sensitive
412 to carbohydrate changes based on the sensitivity criteria defined above.

413 A line was fit to the set of optimal diets predicted for each subject. The slopes of the lines were
414 used to classify subjects into carbohydrate or fat sensitive categories. Lines that tend to be more
415 horizontal (green lines; slope > -1) indicate individuals with greater sensitivity to fat change.

416 Lines that tend to be more vertical (pink lines; slope < -1) indicate individuals with greater
417 sensitivity to carbohydrate change.

418

419 **Discussion**

420 Diet therapy can be an effective non-pharmacological method to delay or prevent the onset of
421 T2D; however, diet therapy has not been shown to be consistently effective [4–6,22]. The lack of
422 effectiveness of diet therapy could be due to personalized dietary requirements [7–9]. Previous
423 studies showed that individuals receiving an identical standardized low-energy diet show
424 variability in their weight trajectories [28]. Metabolic heterogeneity among individuals could be
425 due to genetic and epigenetic factors, microbiome, lifestyle, and environmental exposure [29].
426 Personalized nutrition is a growing area of focus for both patients and experts. Optimizing diet
427 change to individual physiological responses could maximize the impact of lifestyle intervention;
428 however, tools that can enable customization of interventions at the individual level are lacking.
429 We demonstrate, for the first time to our knowledge, the application of a computational
430 simulation model as a tool to optimize diets for prediabetic individuals.

431

432 The emergence of digital twins and digital representation of objects or individuals provides a
433 new opportunity to tailor individualized interventions [30]. We used a previously developed and
434 tested mechanistic simulation model of human physiological processes involved in the onset and
435 progression of diabetes to create digital twins of a subset of pre-diabetic subjects from the J-
436 DOIT1 study. In the default setting, the parameters of the model are calibrated to represent a
437 “typical” individual. When individual-level time-course data, such as body weight and HbA1c
438 level over time are available, selected parameters of the model can be calibrated to fit the model

439 to an individual subject's data, which leads to a model customized to the subject, i.e., a digital
440 twin of the individual. The digital twin provides a platform to conduct computational
441 experiments quickly and safely in an *in silico* environment. Digital twins were utilized in this
442 study to explore and optimize lifestyle recommendations through simulation.

443
444 We leveraged the simulation model to understand the inter-individual variability in responses to
445 lifestyle interventions in the J-DOIT1 study. The selected individuals from the intervention arm
446 were baseline matched with the participants from the control arm of the study. The baseline-
447 matched individuals from the control arm formed the training set ($n = 53$), and individuals
448 selected from the intervention arm comprised the test dataset ($n = 59$). Each subject from the
449 training set was calibrated using the simulation model to generate a unique combination of
450 physiological and lifestyle parameters that defined the digital twin of that subject. We assumed
451 that individuals with similar baseline characteristics (age, sex, height, weight, and HbA1c) have
452 similar physiological parameters and historical lifestyle. Therefore, physiological, and historical
453 lifestyle parameters were replicated for the test subjects within each baseline-matched train-test
454 pair. The post-baseline lifestyle parameters of the test subjects were allowed to change to explain
455 the observed body weight and HbA1c trends. The digital twins thus generated captured the
456 individual-level dynamics of the body weight with an error of 1.1% (± 1.0) and HbA1c levels
457 with an error of 1.4% (± 1.4) relative to the actual measurements over a follow-up period of
458 approximately 4 years.

459
460 The digital twins enabled the exploration of inter-individual variability in response to diet
461 intervention. The digital twins created using the model were used to estimate the actual lifestyle

462 change in terms of total caloric intake for all individuals in the training and testing datasets. We
463 observed that the measured change in body weight generally increased with the model-predicted
464 increase in daily caloric intake; however, similar changes in daily calories were predicted to
465 result in a relatively wide band of weight change (approximately ± 2.5 kg around the line of best
466 fit, or a range of 5 kg) (Fig4). This suggests that changes in calories alone may not be sufficient
467 to predict individual-level changes in body weight and elucidates the significance of physiology,
468 among other factors, in determining an individual's response to diet.

469
470 Just as exogenous lifestyle factors were not fully predictive of the outcome, endogenous
471 physiological parameters were also not found to be correlated with the outcome. This suggests
472 that the outcome of a lifestyle change is an emergent property of complex interactions between
473 underlying physiological processes and exogenous changes. Predicting such a response,
474 therefore, requires an understanding of the complex interactions driving the response. Our
475 physiology-based, quantitative framework, which captures such interactions by design, is well-
476 suited for this purpose.

477
478 Having tested the model's ability to satisfactorily describe individual-level dynamics of body
479 weight and HbA1c, we applied the model to generate optimal diet recommendations for
480 individuals in the training and testing datasets. Monte Carlo simulations were performed for each
481 individual using their digital twin, and a unique set of "optimal" carbohydrate and fat changes
482 required for a targeted 5-7% reduction in body weight was determined. The model predicted that
483 there is no single optimal diet to achieve the target body weight. Analysis of optimal diet
484 trajectories at the subject levels suggested that while some patients required tight control over fat

485 intake (individuals sensitive to fat change), others required a a greater focus on managing
486 carbohydrate intake (individual more sensitive to carbohydrate change). Furthermore, the set of
487 optimal diets could be further refined by including additional goals, e.g., a targeted reduction in
488 HbA1c. This result supports the role of personalized nutrition and dietary recommendations in
489 improving health outcomes and demonstrates the potential utility of our approach in identifying
490 such personalized recommendations based on historical subject data.

491
492 The modeling and analyses presented in this work are affected by a few limitations of data and
493 methodology that should be acknowledged. The target population of our analysis only included
494 Japanese individuals with prediabetes, thus limiting the generalizability of the predictions. The
495 matching algorithm used to create pairs of train-test subjects allowed a small degree of mismatch
496 so that matched pairs could be practically found. The assumption of physiological identity
497 between the matched pairs has, therefore, some inaccuracy inherent to it and could impact the
498 estimation of parameters as well as model predictions. Furthermore, all lifestyle changes were
499 simulated as step functions, as this was mathematically the simplest form in the absence of
500 additional information on individual lifestyle habits. In real life, lifestyle factors may be much
501 more variable and may follow trends very different from a step function. This assumption is
502 likely to impact the timing and rate of change of model-predicted variables like body weight.
503 Finally, the mechanistic mathematical model used in this study makes several assumptions about
504 the physiological processes underlying diabetes onset and progression, which may not always
505 reflect the underlying biology and physiology accurately. Nonetheless, even with these
506 limitations, the model predicted the body weight and HbA1c time courses of the training as well

507 as test groups with high accuracy, which lends credence to the model and supports its use for
508 predictive analysis.

509

510 An advantage of the model-based framework developed in this study over approaches like
511 precision nutrition is that it can provide optimal dietary recommendations without requiring
512 specific genetic and microbiome data, making it a quicker, lower-cost alternative. Prior
513 validation of the simulation model using long-term data [20] and additional validation in this
514 work using a subset of participants from the J-DOIT1 study showed that the framework predicts
515 weight changes and glycemic control in individuals with high accuracy. This provides assurance
516 that the framework can be used to predict optimal dietary recommendations for prediabetic
517 individuals. Generatability was limited and careful attention should be paid for interpretation
518 results because of the target population (Japanese adults with prediabetes). A prospective study
519 in human subjects is required to build further confidence in this simulation model framework and
520 confirm its utility in clinical practice.

521

522 The latest Dietary Guidelines for Americans (DGA) focus on limiting fat, especially saturated
523 fat, and allowing higher carbohydrate intake. Volek *et al.* have argued that the DGA
524 recommendations of a low-fat high-carbohydrate diet for the past several years have coincided
525 with rapidly escalating epidemics of obesity and T2D that contribute to the progression of
526 cardiovascular diseases [31]. This guideline lacks flexibility and does not appreciate the
527 heterogeneity in individuals' responses to dietary interventions. The findings of the J-DOIT1
528 study, coupled with the model-based framework for diet optimization presented in the study,
529 offer additional evidence to convince experts and policymakers of the need for optimal diet

530 interventions because of inter-individual variability in responses to identical diets. Our modeling
531 framework can simulate changes in body weight and glycemic control as a result of lifestyle
532 interventions at an individual level. The ability to optimize nutritional strategies using this model
533 could help dieticians and physicians personalize diet recommendations to their patients' goals.

534 **Funding information**

535 This work was supported by JSPS KAKENHI Grant Number 18K01988

536 **Disclosure of ethical statements**

537 This study conformed to the standards of the Declaration of Helsinki.

538 Approval of the research protocol: The present study was approved by the ethics committee of
539 the National Hospital Organization Kyoto Medical Center (No.16-102).

540 Informed consent or substitute for it was obtained from all patients for being included in the
541 study.

542 Approval date of Registry and the Registration No. of the study/trial: Trial registration number:
543 University hospital Medical Information Network (UMIN) Center: UMIN000000662).

544

545 **References**

- 546 1. Centers for Disease Control and Prevention. National Diabetes Statistics Report, 2020.
547 Atlanta, GA: Centers for Disease Control and Prevention, U.S. Dept of Health and Human
548 Services. 2020.
- 549 2. Hunt D, Hemmingsen B, Matzke A, Varghese C, Hammerich A, Luciani S, et al. The WHO
550 Global Diabetes Compact: a new initiative to support people living with diabetes. *Lancet*
551 *Diabetes Endocrinol.* 2021;9: 325–327. doi:10.1016/S2213-8587(21)00111-X
- 552 3. Organization WH. Global report on diabetes. World Health Organization; 2016.

- 553 4. Knowler WC, Barrett-Connor E, Fowler SE, Hamman RF, Lachin JM, Walker EA, et al.
554 Reduction in the incidence of type 2 diabetes with lifestyle intervention or metformin. *N*
555 *Engl J Med.* 2002;346: 393–403. doi:10.1056/NEJMoa012512
- 556 5. Tuomilehto J, Lindström J, Eriksson JG, Valle TT, Hämäläinen H, Ilanne-Parikka P, et al.
557 Prevention of type 2 diabetes mellitus by changes in lifestyle among subjects with impaired
558 glucose tolerance. *N Engl J Med.* 2001;344: 1343–1350.
559 doi:10.1056/NEJM200105033441801
- 560 6. Ramachandran A, Snehalatha C, Mary S, Mukesh B, Bhaskar AD, Vijay V. The Indian
561 Diabetes Prevention Programme shows that lifestyle modification and metformin prevent
562 type 2 diabetes in Asian Indian subjects with impaired glucose tolerance (IDPP-1).
563 *Diabetologia.* 2006;49: 289–297. doi:10.1007/s00125-005-0097-z
- 564 7. Solomon TPJ. Sources of Inter-individual Variability in the Therapeutic Response of Blood
565 Glucose Control to Exercise in Type 2 Diabetes: Going Beyond Exercise Dose. *Front*
566 *Physiol.* 2018;9: 896. doi:10.3389/fphys.2018.00896
- 567 8. Faerch K, Hulmán A, Solomon TPJ. Heterogeneity of Pre-diabetes and Type 2 Diabetes:
568 Implications for Prediction, Prevention and Treatment Responsiveness. *Curr Diabetes Rev.*
569 2016;12: 30–41. doi:10.2174/1573399811666150416122903
- 570 9. Böhm A, Weigert C, Staiger H, Häring H-U. Exercise and diabetes: relevance and causes for
571 response variability. *Endocrine.* 2016;51: 390–401. doi:10.1007/s12020-015-0792-6
- 572 10. Wang DD, Hu FB. Precision nutrition for prevention and management of type 2 diabetes.
573 *Lancet Diabetes Endocrinol.* 2018;6: 416–426. doi:10.1016/S2213-8587(18)30037-8
- 574 11. Heianza Y, Qi L. Gene-Diet Interaction and Precision Nutrition in Obesity. *Int J Mol Sci.*
575 2017;18. doi:10.3390/ijms18040787
- 576 12. Wyness L. Understanding the role of diet in type 2 diabetes prevention. *Br J Community*
577 *Nurs.* 2009;14: 374–379. doi:10.12968/bjcn.2009.14.9.43803
- 578 13. Brouns F. Overweight and diabetes prevention: is a low-carbohydrate-high-fat diet
579 recommendable? *Eur J Nutr.* 2018;57: 1301–1312. doi:10.1007/s00394-018-1636-y
- 580 14. Yang Q, Lang X, Li W, Liang Y. The effects of low-fat, high-carbohydrate diets vs. low-
581 carbohydrate, high-fat diets on weight, blood pressure, serum lipids and blood glucose: a
582 systematic review and meta-analysis. *Eur J Clin Nutr.* 2021. doi:10.1038/s41430-021-
583 00927-0
- 584 15. Turton J, Brinkworth GD, Field R, Parker H, Rooney K. An evidence-based approach to
585 developing low-carbohydrate diets for type 2 diabetes management: A systematic review of
586 interventions and methods. *Diabetes Obes Metab.* 2019;21: 2513–2525.
587 doi:10.1111/dom.13837

- 588 16. Tay J, Luscombe-Marsh ND, Thompson CH, Noakes M, Buckley JD, Wittert GA, et al.
589 Comparison of low- and high-carbohydrate diets for type 2 diabetes management: a
590 randomized trial. *Am J Clin Nutr*. 2015;102: 780–790. doi:10.3945/ajcn.115.112581
- 591 17. Mansoor N, Vinknes KJ, Veierød MB, Retterstøl K. Effects of low-carbohydrate diets v.
592 low-fat diets on body weight and cardiovascular risk factors: a meta-analysis of randomised
593 controlled trials. *Br J Nutr*. 2016;115: 466–479. doi:10.1017/S0007114515004699
- 594 18. Wang L-L, Wang Q, Hong Y, Ojo O, Jiang Q, Hou Y-Y, et al. The Effect of Low-
595 Carbohydrate Diet on Glycemic Control in Patients with Type 2 Diabetes Mellitus.
596 *Nutrients*. 2018;10. doi:10.3390/nu10060661
- 597 19. Guldbbrand H, Dizdar B, Bunjaku B, Lindström T, Bachrach-Lindström M, Fredrikson M, et
598 al. In type 2 diabetes, randomisation to advice to follow a low-carbohydrate diet transiently
599 improves glycaemic control compared with advice to follow a low-fat diet producing a
600 similar weight loss. *Diabetologia*. 2012;55: 2118–2127. doi:10.1007/s00125-012-2567-4
- 601 20. Sarkar J, Dwivedi G, Chen Q, Sheu IE, Paich M, Chelini CM, et al. A long-term mechanistic
602 computational model of physiological factors driving the onset of type 2 diabetes in an
603 individual. *PLOS ONE*. 2018;13: 1–37. doi:10.1371/journal.pone.0192472
- 604 21. Sakane N, Kotani K, Takahashi K, Sano Y, Tsuzaki K, Okazaki K, et al. Japan Diabetes
605 Outcome Intervention Trial-1 (J-DOIT1), a nationwide cluster randomized trial of type 2
606 diabetes prevention by telephone-delivered lifestyle support for high-risk subjects detected
607 at health checkups: rationale, design, and recruitment. *BMC Public Health*. 2013;13: 81.
608 doi:10.1186/1471-2458-13-81
- 609 22. Sakane N, Kotani K, Takahashi K, Sano Y, Tsuzaki K, Okazaki K, et al. Effects of
610 telephone-delivered lifestyle support on the development of diabetes in participants at high
611 risk of type 2 diabetes: J-DOIT1, a pragmatic cluster randomised trial. *BMJ Open*. 2015;5:
612 e007316. doi:10.1136/bmjopen-2014-007316
- 613 23. Storn R, Price K. Differential Evolution – A Simple and Efficient Heuristic for global
614 Optimization over Continuous Spaces. *J Glob Optim*. 1997;11: 341–359.
615 doi:10.1023/A:1008202821328
- 616 24. Yorkin M, Spaccarotella K, Martin-Biggers J, Quick V, Byrd-Bredbenner C. Accuracy and
617 consistency of weights provided by home bathroom scales. *BMC Public Health*. 2013;13:
618 1194. doi:10.1186/1471-2458-13-1194
- 619 25. Stein RJ, Haddock CK, Poston WSC, Catanese D, Spertus JA. Precision in weighing: a
620 comparison of scales found in physician offices, fitness centers, and weight loss centers.
621 *Public Health Rep Wash DC* 1974. 2005;120: 266–270. doi:10.1177/003335490512000308
- 622 26. Klonoff DC, Aron D, Cohen RM, Home P, John WG, Little RR, et al. The Need for
623 Accuracy in Hemoglobin A1c Proficiency Testing: Why the Proposed CLIA Rule of 2019 Is
624 a Step Backward. *J Diabetes Sci Technol*. 2019/03/22 ed. 2019;13: 424–427.
625 doi:10.1177/1932296819841699

- 626 27. Kuniyoshi H, Ohde S, Deshpande G, Takahashi O. Measurement error of HbA1c for
627 screening diabetes among healthy Japanese adults. Preventing Overdiagnosis. Barcelona;
628 2016. Available:
629 <https://www.preventingoverdiagnosis.net/2016Presentations/KuniyoshiHayashi.pdf>
- 630 28. Holzapfel C, Dawczynski C, Henze A, Simon M-C. Personalized dietary recommendations
631 for weight loss. A scientific perspective from various angles. Ernahrungs Umsch. 2021;68:
632 26–35.
- 633 29. Zeisel SH. Precision (Personalized) Nutrition: Understanding Metabolic Heterogeneity.
634 Annu Rev Food Sci Technol. 2020;11: 71–92. doi:10.1146/annurev-food-032519-051736
- 635 30. Kamel Boulos MN, Zhang P. Digital Twins: From Personalised Medicine to Precision Public
636 Health. J Pers Med. 2021;11. doi:10.3390/jpm11080745
- 637 31. Volek JS, Phinney SD, Krauss RM, Johnson RJ, Saslow LR, Gower B, et al. Alternative
638 Dietary Patterns for Americans: Low-Carbohydrate Diets. Nutrients. 2021;13.
639 doi:10.3390/nu13103299

640

641 **Supporting information**

642 **S1 Fig. Calibrated pairs for best responders, low call frequency group.**

643 **S2 Fig. Calibrated pairs for best responders, medium call frequency group.**

644 **S3 Fig. Calibrated pairs for best responders, high call frequency group.**

645 **S4 Fig. Calibrated pairs for worst responders, low call frequency group.**

646 **S5 Fig. Calibrated pairs for worst responders, medium call frequency group.**

647 **S6 Fig. Calibrated pairs for worst responders, high call frequency group.**

648 **S7 Fig. Measured vs Predicted Biomarkers.** Model-predicted body weight and HbA1c values

649 for all subjects across time points show reasonable concordance with corresponding measured

650 values with most values lying on or close to the line of identity.

651

652 **S8 Fig. Model-estimated change in calories vs measured change in HbA1c from baseline.**

653 The measured change in HbA1c from baseline to the first follow-up during the J-DOIT1

654 intervention plotted against model-estimated change in calories per day due to both diet and
655 exercise changes averaged over the same period for subjects in the intervention arm. The gray
656 number in each quadrant is the fraction of data points in that quadrant. The data points fit a linear
657 regression model (solid gray line) with $r^2 = 0.20$ and a residual standard error of 0.28 points.
658

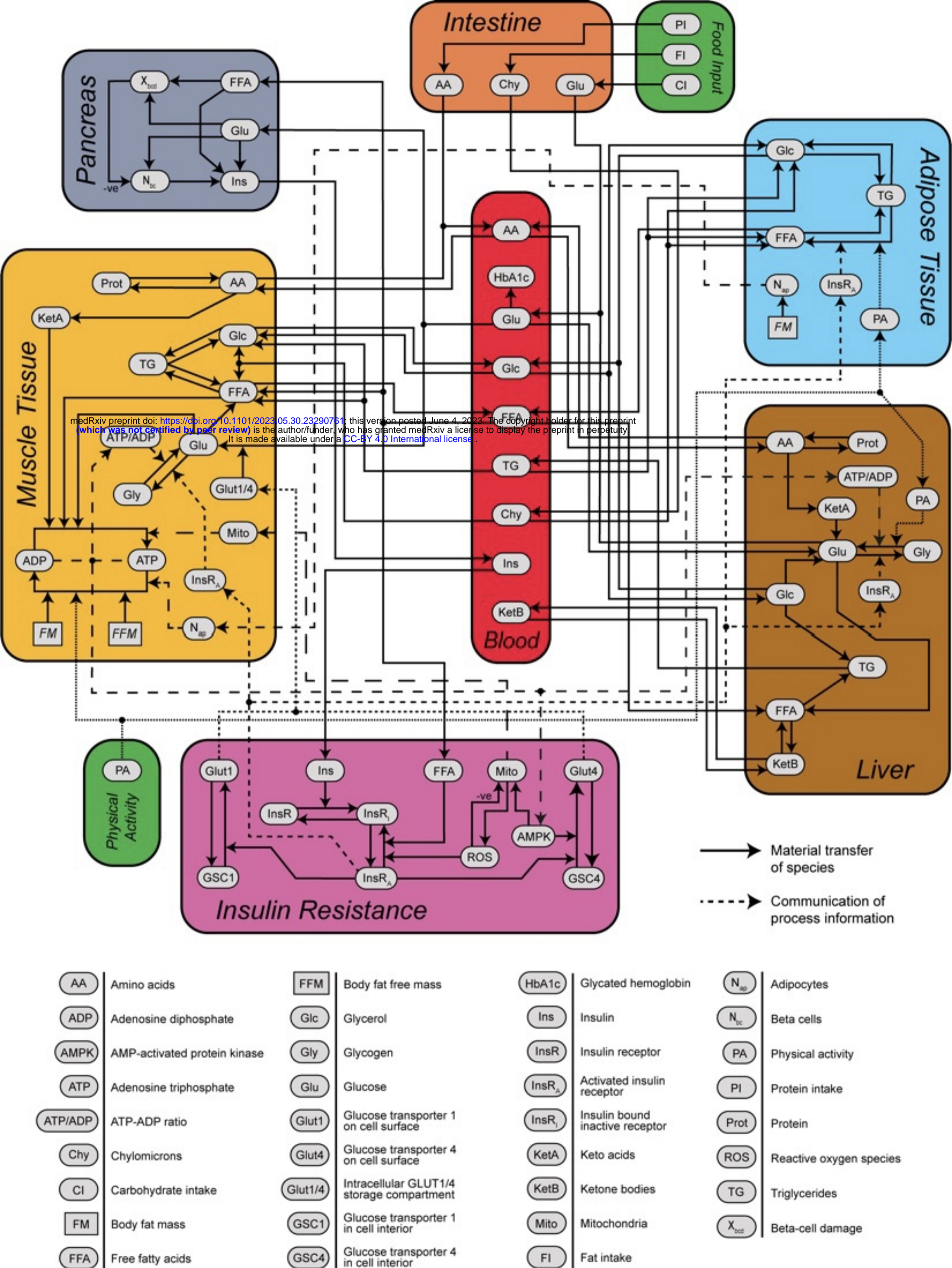

Figure 1. Simulation Model.

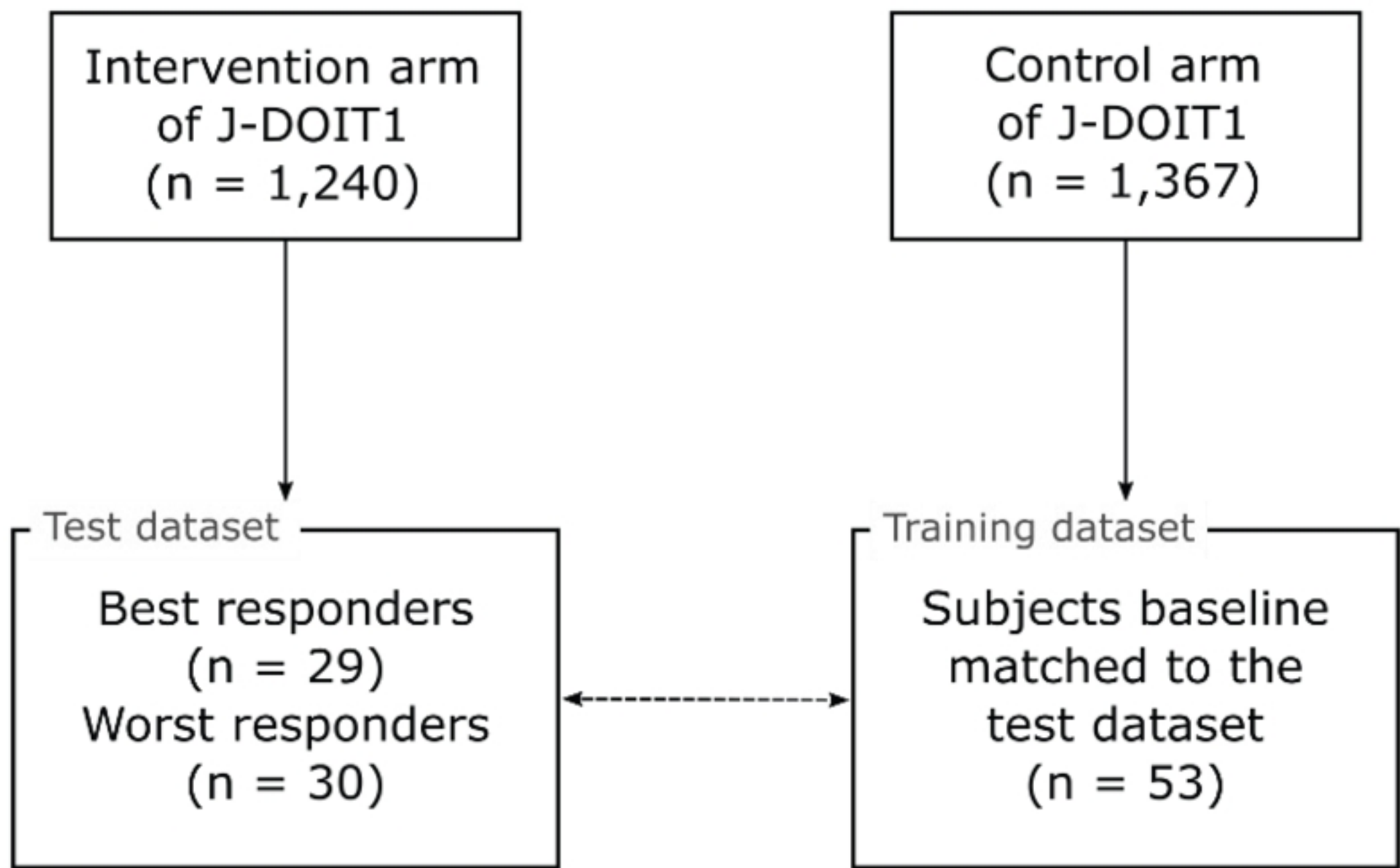

Figure 2. Subject selection and study design.

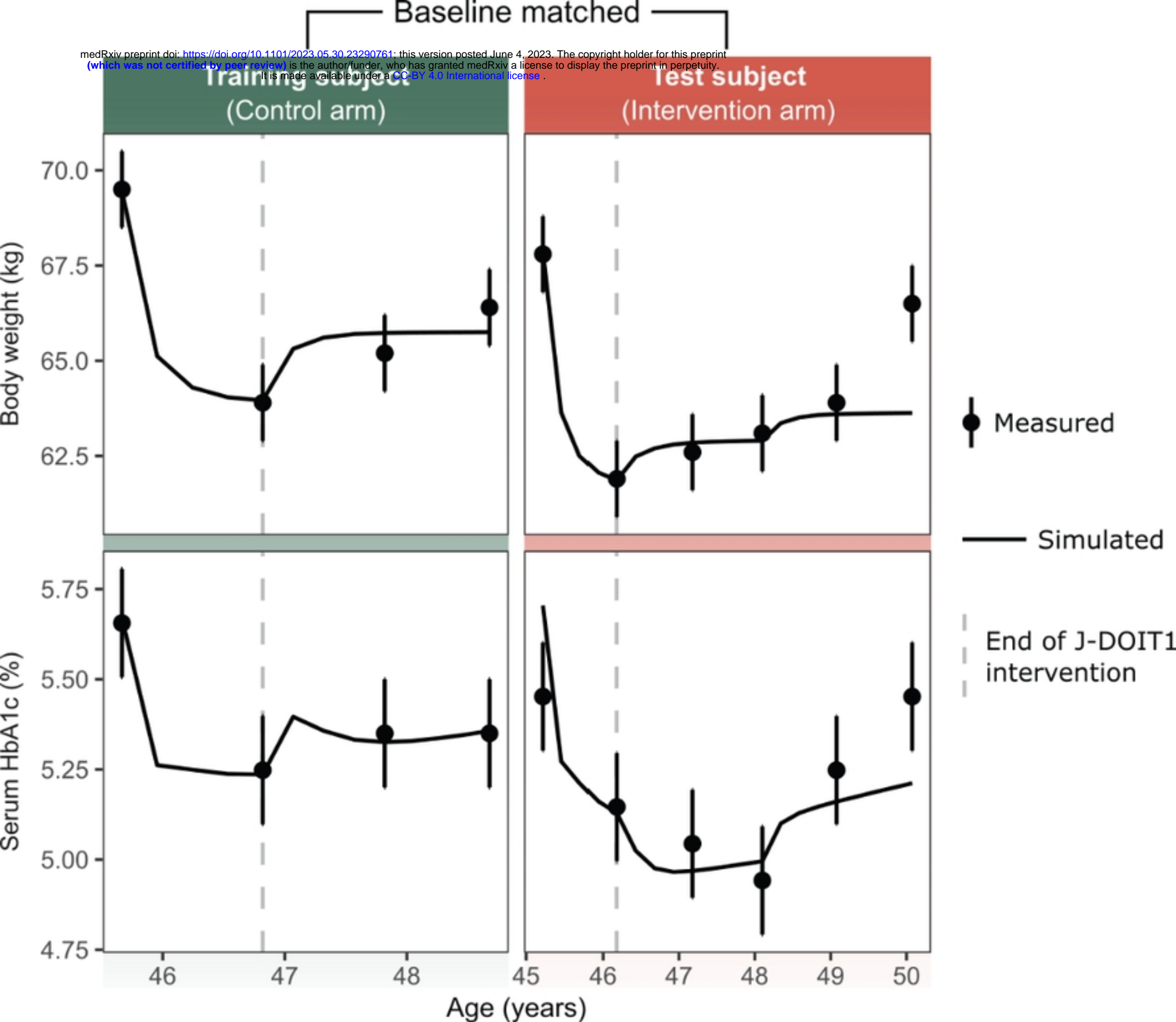

Figure 3. An example of model prediction for a pair of baseline-matched subjects.

● Best responder ● Worst responder

medRxiv preprint doi: <https://doi.org/10.1101/2023.05.30.23290761>; this version posted June 4, 2023. The copyright holder for this preprint (which was not certified by peer review) is the author/funder, who has granted medRxiv a license to display the preprint in perpetuity. It is made available under a [CC-BY 4.0 International license](https://creativecommons.org/licenses/by/4.0/).

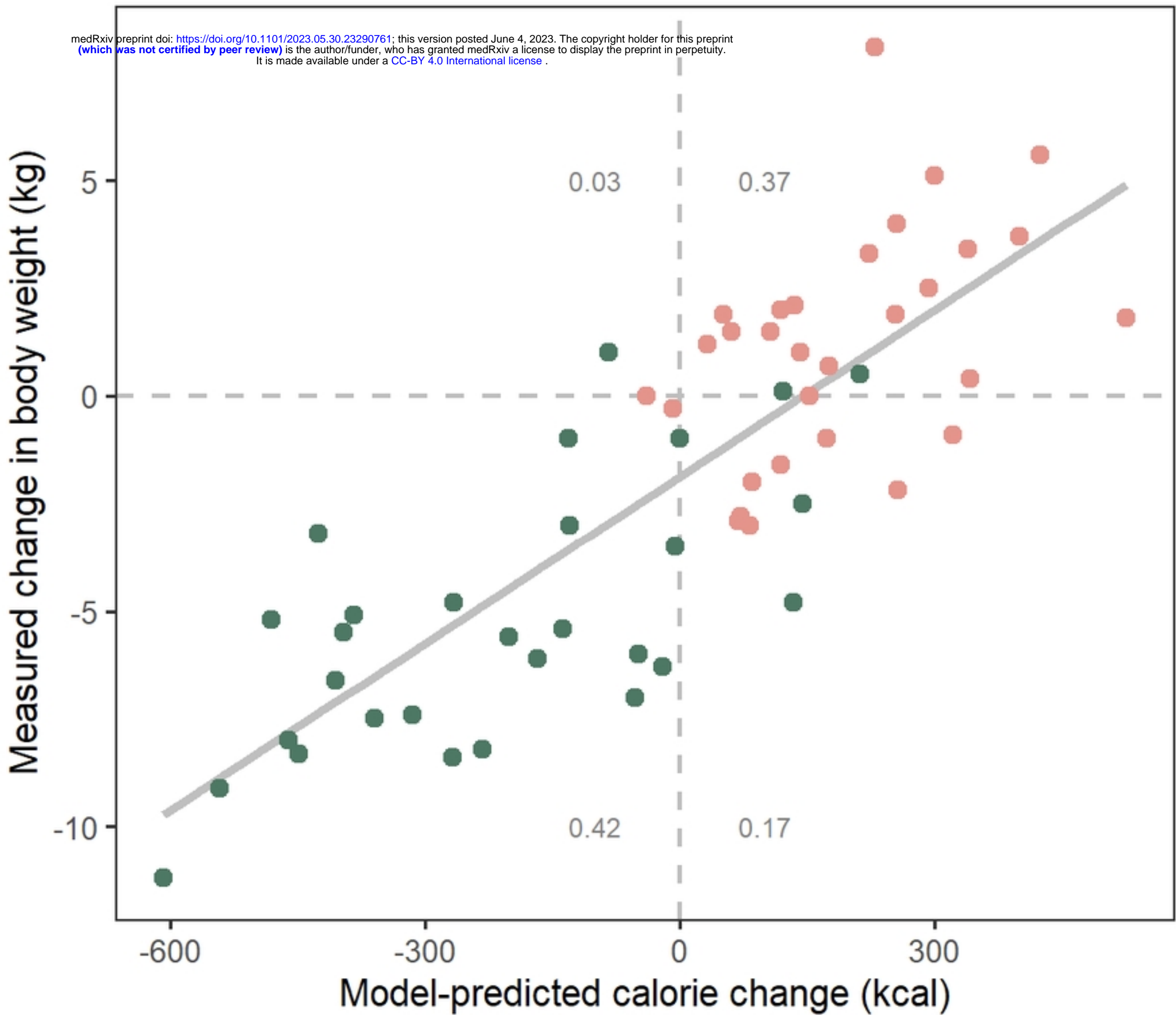

Figure 4. Model-predicted caloric change versus weight change f

● Subject ID: Test-041

● Subject ID: Test-044

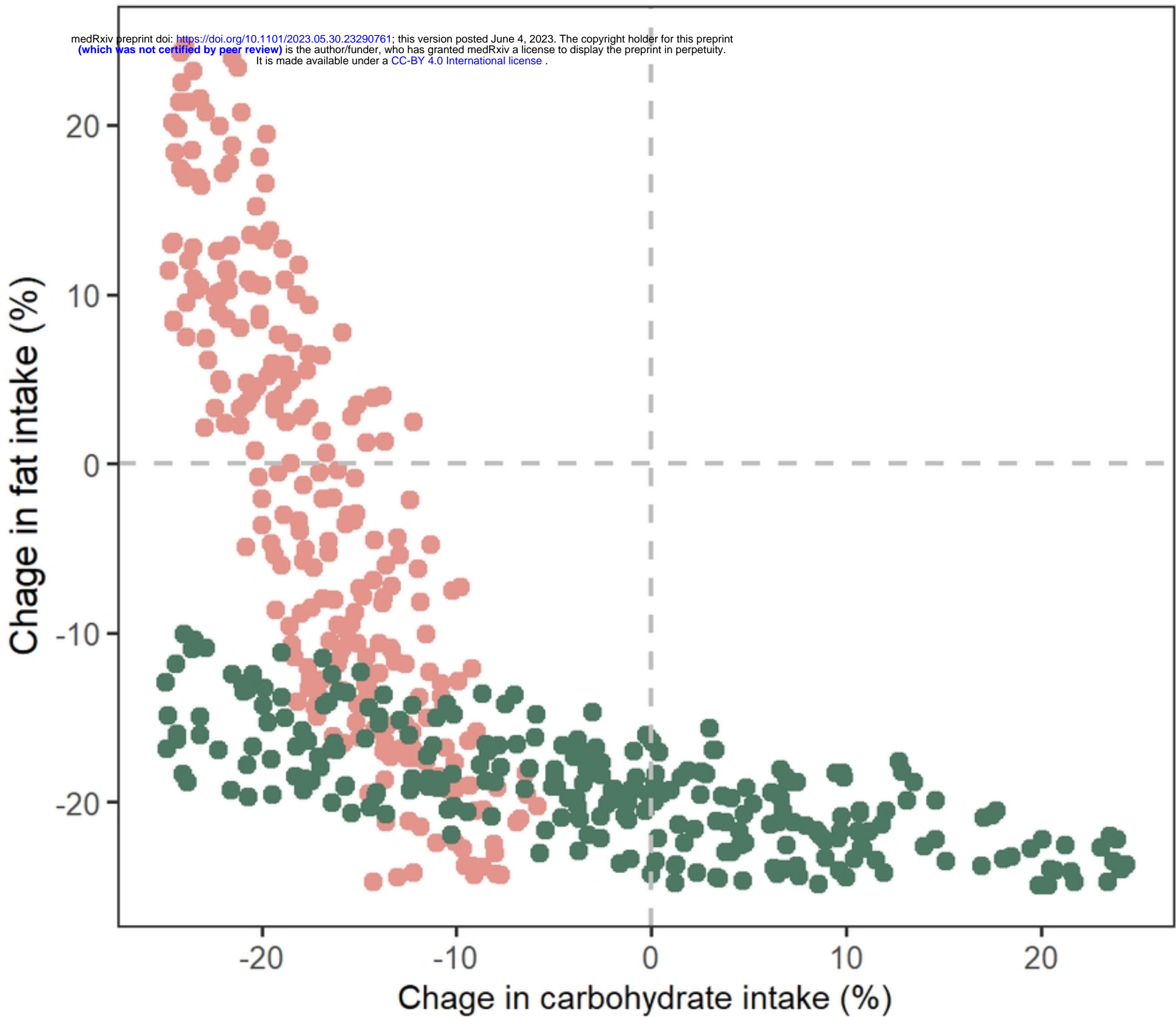

Figure 5. Optimal changes in carbohydrate and fat intake for target

● 5-7% reduction in weight

● 5-7% reduction in weight and 0.1-0.2 point reduction in A1c

medRxiv preprint doi: <https://doi.org/10.1101/2023.05.30.23290761>; this version posted June 4, 2023. The copyright holder for this preprint (which was not certified by peer review) is the author/funder, who has granted medRxiv a license to display the preprint in perpetuity. It is made available under a [CC-BY 4.0 International license](https://creativecommons.org/licenses/by/4.0/).

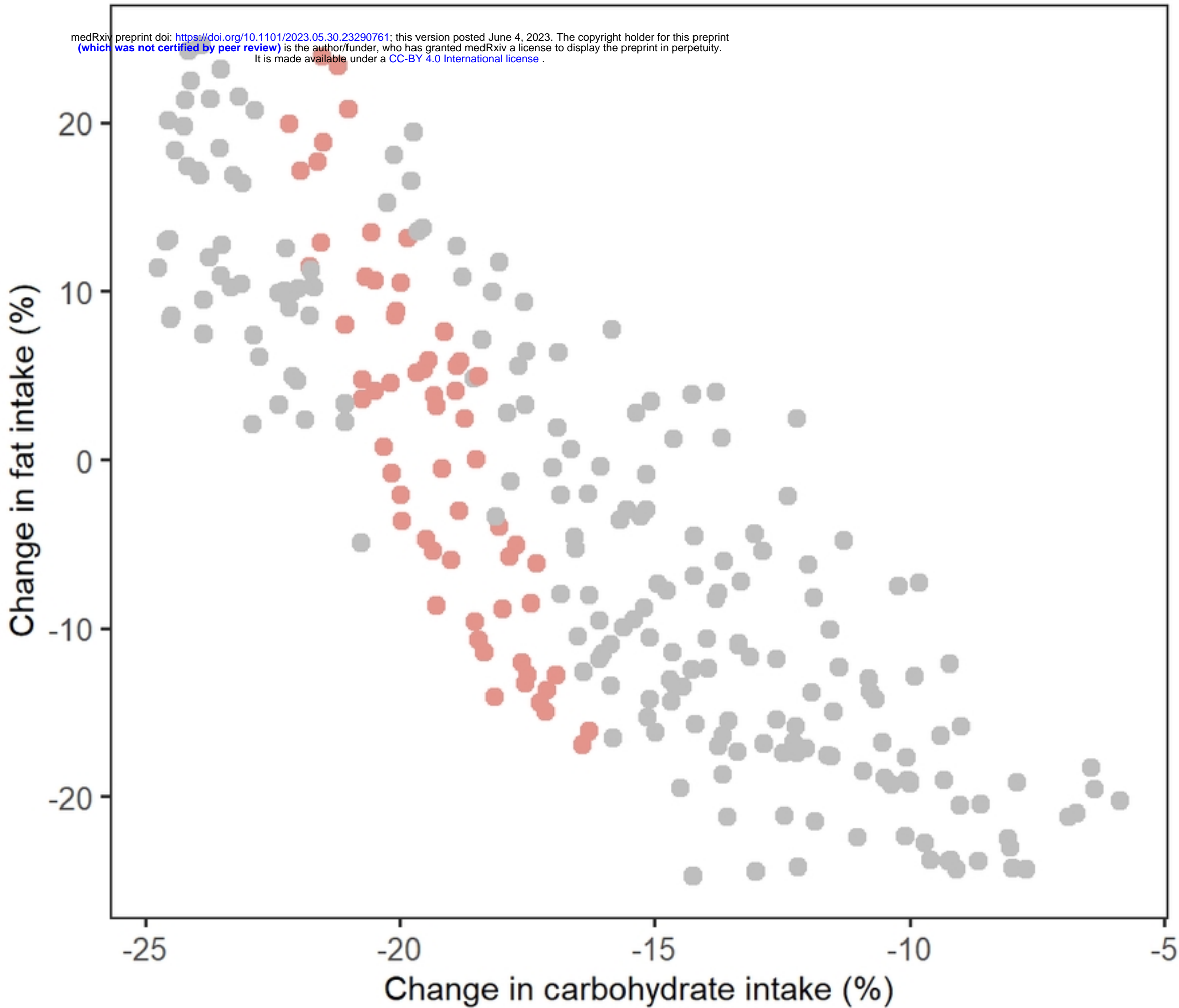

Figure 6. Including additional biomarker targets further narrows

— Fat sensitive — Carbohydrate sensitive

medRxiv preprint doi: <https://doi.org/10.1101/2023.05.30.23290761>; this version posted June 4, 2023. The copyright holder for this preprint (which was not certified by peer review) is the author/funder, who has granted medRxiv a license to display the preprint in perpetuity. It is made available under a [CC-BY 4.0 International license](https://creativecommons.org/licenses/by/4.0/).

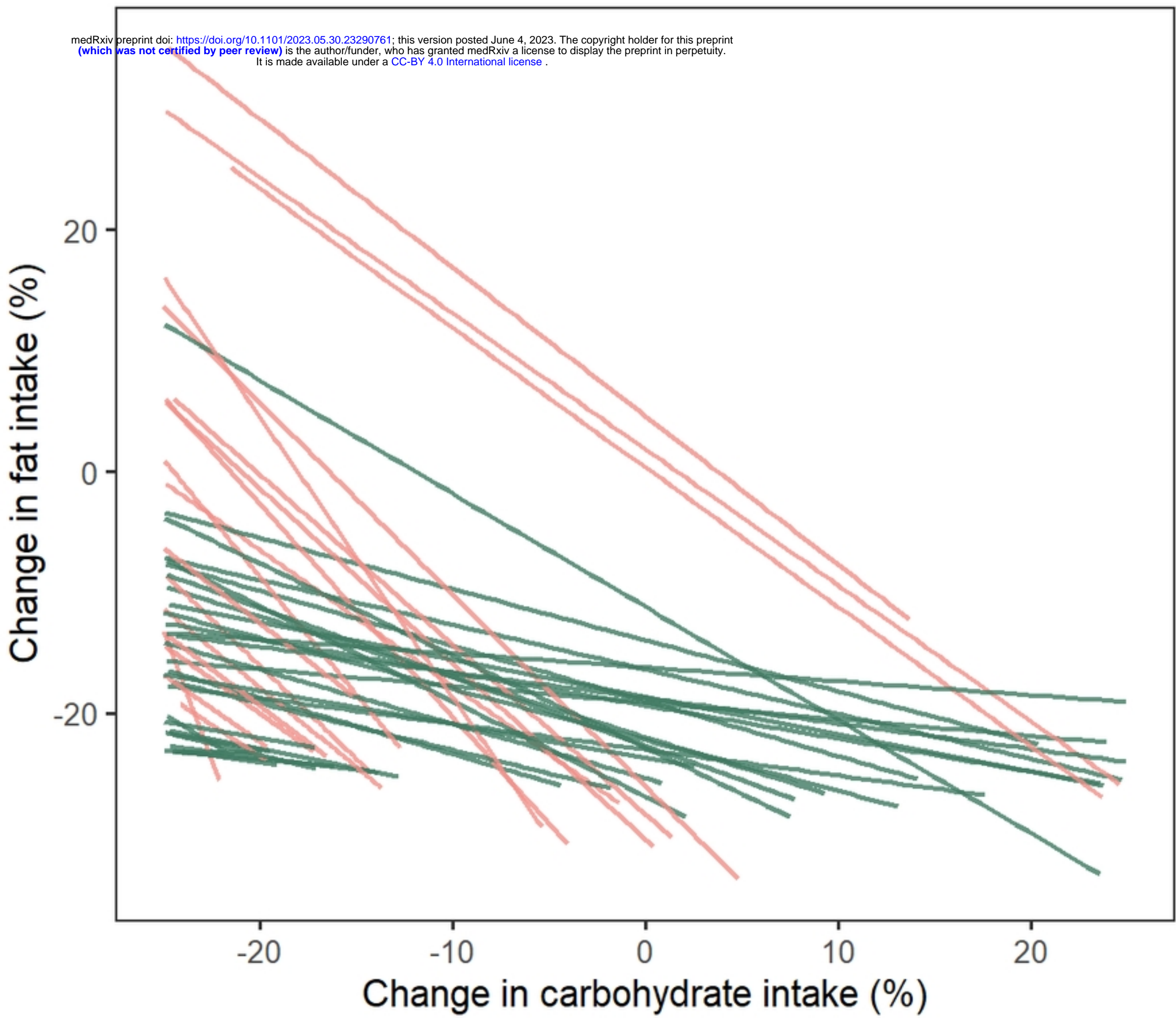

Figure 7. Optimal diet trajectories and relative sensitivity to macr