

1 **From bedside to bench and back: discovery of a novel missense**
2 **variant in NLRP3 causing atypical CAPS with hearing loss as the**
3 **primary presentation, responsive to anti-IL-1 therapy**

4 **Merav Birk-Bachar¹, Hadar Cohen², Efrat Sofrin-Drucker^{3,6,7}, Nesia Kropach-Gilad^{3,6,7},**
5 **Naama Orenstein^{3,6,7}, Gabriel Lidzbarsky⁶, Liora Kornreich^{4,7}, Rotem Tal^{1,7}, Gil**
6 **Amarilyo^{1,7}, Yoel Levinsky^{1,7}, Meirav Sokolov^{5,7}, Eyal Raveh^{5,7}, Motti Gerlic² †, Liora**
7 **Harel^{1,7} †**

8 †These authors contributed equally to this work and share senior authorship

9
10 ¹ Pediatric Rheumatology Unit, Schneider Children's Medical Center of Israel, Petach-Tikva,
11 Israel

12 ² Department of Clinical Microbiology and Immunology, Sackler Faculty of Medicine, Tel
13 Aviv University, Tel-Aviv, Israel

14 ³ Genetics Unit, Schneider Children's Medical Center of Israel, Petach-Tikva, Israel

15 ⁴ Pediatric Imaging Unit, Schneider Children's Medical Center of Israel, Petach-Tikva, Israel

16 ⁵ Pediatric Ear Nose and Throat Unit, Schneider Children's Medical Center of Israel, Petach-
17 Tikva, Israel

18 ⁶ Recanati Genetic Institute, Rabin Medical Center-Beilinson Hospital, Petach Tikva, Israel

19 ⁷ Sackler Faculty of Medicine, Tel Aviv University, Tel-Aviv, Israel

20 ***Correspondence;**

21 Dr. Merav Birk-Bachar – Merav.birk@gmail.com

22 Associate Prof. Motti Gerlic – mgerlic@tauex.tau.ac.il

23 Prof. Liora Harel - liorahar@clalit.org.il

24

25

26 **Number of words in manuscript:** 4308 **Number of figures:** 6

27

28 **Keywords:** **Inflammasome, caspase-1, deafness, anakinra, sensori-neural,**
29 **autoinflammation**

30 **ABSTRACT**

31 Cryopyrin-associated periodic syndromes (CAPS) also known as NLRP3-associated
32 auto-inflammatory diseases, are a spectrum of rare auto-inflammatory diseases caused by
33 gain-of-function mutations in the NLRP3 gene, resulting in inflammasome hyper-activation and
34 dysregulated release of Interleukin-1 β (IL-1 β). Many patients with CAPS develop progressive
35 sensorineural hearing loss (SNHL) due to cochlear auto-inflammation which, in rare cases,
36 may be the sole manifestation. This study was undertaken to establish the suspected diagnosis
37 of CAPS in a family presenting autosomal dominant progressive/acute SNHL and a novel
38 missense variant in the NLRP3 gene of unknown significance (NM_001079821:c.1790G>A,
39 p.Ser597Asn). To do so, we conducted an ex vivo functional assessment of the NLRP3
40 inflammasome in carriers (n=10) and healthy family members (n=5). The assay revealed
41 hyper-activation of the inflammasome among carriers, supporting the hypothesis that this
42 missense variant is a pathogenic gain-of-function mutation. Administration of anti-IL-1
43 therapy resulted in a substantial clinical improvement among pediatric patients, who
44 exhibited near resolution of hearing impairment within 1-3 months of treatment. Our findings
45 highlight the crucial role of early diagnosis and treatment of hearing loss due to
46 hyperactivation of the inflammasome with an anti-IL-1 agent in reversing cochlear damage.
47 Furthermore, our results suggest that high and ultrahigh frequency ranges need to be included
48 in the auditory assessment to enable early detection of subclinical SNHL. Finally,
49 incorporating functional inflammasome assessment as part of the clinical evaluation could
50 establish the diagnosis in inconclusive cases.

51

52 **Introduction**

53 The NLRP3 inflammasome[1] is an intracellular innate immune sensor expressed in
54 immune cells, including monocytes and macrophages. Gain-of-function mutations in the
55 NLRP3 gene lead to hyperactivation of the NLRP3 inflammasome, resulting in the
56 inappropriate release of inflammatory cytokines, including IL-1 β , and causing a spectrum of
57 autosomal-dominant systemic autoinflammatory diseases called cryopyrin-associated
58 periodic syndromes (CAPS) or NLRP3-associated autoinflammatory diseases (NLRP3-
59 AIDs)[2,3]. The CAPS spectrum includes three classical clinical subtypes: neonatal-onset
60 multisystem inflammatory disease (NOMID, MIM 607115), Muckle-Wells syndrome (MWS,
61 MIM 191900), and familial cold autoinflammatory syndrome (FCAS, MIM 120100). The age
62 at onset, as well as the severity of symptoms, vary within this spectrum and include recurrent
63 fever, typical urticaria-like rash, headache, conjunctivitis, and arthralgia or arthritis.[3] Many
64 of these patients, particularly those with the more severe phenotypes, also develop
65 progressive sensorineural hearing loss (SNHL) due to cochlear auto-inflammation(Yamada et
66 al., 2022(. In rare cases, SNHL may be the primary finding, and it was suggested that cochlear
67 auto-inflammation was caused by hyper-activation of the NLRP3 inflammasome in tissue-
68 resident macrophage/monocyte-like cells[5,6].

69 Inflammasomes are a group of cytosolic protein complexes located mainly in myeloid
70 lineage cells that are formed to mediate host immune responses to microbial infection and
71 cellular damage [7]. The NLRP3 inflammasome activation process is dependent on a two-
72 signal sequence. In the absence of either signal, the inflammasome remains inactive. The first
73 "priming" step, initiated by either pathogen-associated molecular pattern molecules
74 (PAMPs), danger-associated molecular patterns (DAMPs), or pro-inflammatory cytokines,
75 activates transcriptional factors NF- κ B/AP1, resulting in the upregulation of inflammasome
76 components as pro-caspase-1 and pro-inflammatory cytokines (i.e., pro-IL-1 β and pro-IL-18).
77 The second "activating" step, initiated by the recognition of either PAMPs or DAMPs, results
78 in the oligomerization of inflammasome protein components [8]. Inflammasome formation
79 then leads to auto-cleavage of caspases-1 and subsequent cleavage of gasdermin-D
80 (GSDMD), which tends to translocate to the outer membrane to form pores and subsequently
81 induce pyroptotic cell death. Inflammasome activation also cleaves pro-IL-1 β and pro-IL-18
82 to their mature and active forms, which are then released through the GSDMD pores, creating
83 a proinflammatory cascade [9,10]. In the case of NLRP3 gain-of-function mutations, the
84 threshold for inflammasome activation may be either impaired or totally lost, resulting in
85 inappropriate activation of the inflammasome. This hyperactivity is classically demonstrated
86 *ex-vivo* by measuring levels of IL-1 β in supernatants of PBMCs, in response to NF- κ B
87 stimulation alone (priming signal).

88 In this study, we present a family that initially presented with autosomal dominant
89 SNHL and a novel variant in the NLRP3 gene of unknown significance, which did not meet
90 CAPS classification criteria. By conducting an *ex-vivo* functional assessment of the NLRP3
91 inflammasome, which showed inflammasome hyperactivity, we strengthened the suspected
92 diagnosis of CAPS. Finally, following this assessment, we applied an anti-IL-1 treatment that
93 resulted in a rapid substantial clinical hearing improvement in young patients.

94 **Results**

95 **Hearing loss as the main or sole presentation of CAPS**

96 The proband, a two-year-old boy at the time of study initiation (III1), was initially
97 referred to the Pediatric Rheumatology Unit due to recurrent episodes of fever and was
98 eventually clinically diagnosed with PFAPA (periodic fever, aphthous stomatitis, pharyngitis,
99 and adenitis). Family history revealed six family members spanning three generations who
100 had previously been diagnosed with autosomal dominant, bilateral, progressive SNHL
101 (Figure 1A, Table 1). The eldest (1st generation) and most severely affected patient was the
102 proband's >70-year-old grandmother (patient I4). She described progressive hearing loss
103 commencing at age 15-20, as well as two episodes of unilateral (left) acute sensorineural
104 hearing loss over the years that partially responded to steroid treatment (Figure 2). She
105 eventually underwent left cochlear implantation at age 50-55. In addition, she suffered from
106 infrequent short episodes of arthritis/arthralgia over the years (Table 1). She denied recurrent
107 episodes of fever (as well as cold-induced episodes), rash, or uveitis/keratitis. Three family
108 members (2nd generation), all in their late 30's or early 40's, were affected (patients II2, II4,
109 and II6). They suffered from symmetrical bilateral mild to severe hearing loss and were
110 hearing aid-dependent (Figure 2). In all cases, hearing impairment was initially diagnosed in
111 their early 20's, without additional pathognomonic systemic CAPS manifestations. One
112 patient (II6) reported a past episode of unilateral acute hearing loss that did not respond to
113 steroid treatment, another reported episodes of arthritis during childhood (II2), and the third
114 sibling (II4) reported PFAPA-like episodes during childhood. Baseline inflammatory markers
115 were mostly within the normal range in these four patients, except for patient I4 (minimally
116 elevated CRP) and patient II2 (slightly elevated SAA) (Table 2).

117 In contrast to the above 1st and 2nd generation carriers, who all suffered from
118 prolonged and severe SNHL, most of the 3rd generation carriers (15 or younger) had normal
119 hearing function (Supplemental Figure 1). Out of the nine known 3rd generation carriers, only
120 three children suffered from hearing loss (patients III2, III4, and III5) (Figure 2 and
121 Supplemental Figure 1C-D). Two suffered bilateral progressive SNHL; one, who initially
122 presented with normal hearing function, was diagnosed with acute unilateral sensorineural
123 hearing deterioration during the study period (patients III4, III5, and III2, respectively). It
124 should be emphasized that all three children were initially diagnosed through annual auditory
125 tests conducted considering the family history rather than due to any complaint of hearing
126 loss at the time. No other typical CAPS signs or symptoms were present. However, both
127 patients III4 and III5 (proband's siblings) reported PFAPA-like episodes that resolved in the
128 first grade. Inflammatory markers were within normal range except for minimally elevated
129 CRP in patient III4, and mildly elevated SAA in patient III2. It should be noted that during
130 the initial asymptomatic period, SAA levels were within normal limits; they increased in
131 parallel to the rapid deterioration in her hearing function.

132 High-resolution MRI of the temporal bones were performed on all affected family
133 members excluding the grandmother (due to technical constraints), with no signs of cochlear
134 inflammation in the late gadolinium enhancement phase.

135

136 **Earlier detection of SNHL in ultra-high frequencies auditory evaluation**

137 All but one affected subject suffered from progressive bilateral SNHL with a down-
138 sloping audiometric configuration and gradual deterioration over the years (Figure 2). The
139 SNHL pattern varied among patients, though most suffered symmetric hearing loss
140 (Supplemental Figure 1B). Two of these subjects (patients I4 and II6) also reported past
141 episodes of unilateral acute SNHL, which had been treated with oral steroids. One of them
142 reported partial improvement (I4). Over the course of the study, patient III2, a seven-year-old
143 female who initially presented with normal hearing function, suffered from acute
144 sensorineural hearing deterioration in her right ear that solely involved the high-ultrahigh
145 ranges (Figure 2). She was diagnosed in her routine semiannual checkup which included
146 these frequency ranges. Patient I4 suffered from bilateral hearing deterioration over the years
147 (Figure 2) until the left ear reached profound SNHL and required cochlear implantation. Age-
148 eligible carriers (three symptomatic and two asymptomatic children ages 6-12) ultra-high
149 frequencies (8KHz–16KHz) were also assessed. In all cases, the hearing deterioration was
150 observed in the high and ultrahigh frequencies earlier than at the low frequencies (Figure 2).
151 Pure-tone audiometry did not reveal a significant air-bone gap in any of the affected
152 individuals.

153 **Identification of a novel NLRP3 variant in all patients**

154 Patient II6 from family 1 was the first in that family to undergo molecular analysis
155 using the Otoscope Genetic Hearing Loss next-generation sequencing (NGS) gene panel (The
156 University of Iowa, Iowa City, Iowa), including 133 genes related to hearing loss. A
157 heterozygous novel variant of unknown significance NM_001079821.3:c.1784G>A
158 p.Ser595Asn (also known as NM_001079821:c.1790G>A, p.Ser597Asn) was reported on
159 exon 5 (coding exon 3) of the NLRP3 gene (Figure 1B). It was predicted to result in a
160 missense substitution. The genomic position does not correspond with a known domain in the
161 NLRP3 protein (Figure 1B). However, a pathogenic variant at the same amino acid position
162 (1783A>G p.Ser595Gly) related to CINCA syndrome was reported [11,12].

163 In the unrelated Family 2, patient 2.1 was diagnosed with Muckle-Wells Syndrome,
164 based on a classical clinical presentation and genetic results. An auto-inflammatory
165 syndromes panel (Invitae Corporation, San Francisco, California) revealed a heterozygous
166 likely pathogenic variant c.1218G>C, p.Met406Ile in NLRP3 (NM_001079821.3) and a
167 heterozygous variant of uncertain clinical significance in NCF2. Following parental
168 segregation testing the variant in NLRP3 was found to be de-novo. The NLRP3 variant is
169 located in the NACHT domain (exon 5).

170 It should be noted that in family 1a the father (II1) of the proband suffered from early-
171 onset hearing loss (non-SNHL). The hearing loss gene panel did not reveal variants in his
172 NLRP3 gene.

173

174

175 **NM_001079821:c.1790G>A variant carriers present functional NLRP3 inflammasome**
176 **hyper activation *ex-vivo***

177 In order to assess whether NM_001079821:c.1790G>A, p.Ser597Asn NLRP3 variant results
178 in inflammasome hyperactivity, we measured the levels of IL-1 β secretion of peripheral-
179 blood mononuclear cells (PBMCs) isolated from our patients, in response to priming signal
180 alone (LPS or LPS+CaCl₂) and in comparison to healthy controls. For technical reasons
181 (patient recruitment to the clinic), we conducted several independent cycles of the
182 experiment. In each cycle, we isolated PBMCs from both NLRP3 variation carriers
183 (c.1790G>A, p.Ser597Asn) and healthy generation-matched family members as controls.
184 Baseline IL-1 β secretion levels (none treated) were comparable among all subjects.
185 Stimulation with LPS or LPS+CaCl₂, resulted in higher IL-1 β secretion from NLRP3
186 variation carriers PBMCs compared to healthy subjects (Figure 3). The specificity of these
187 results to the NLRP3 inflammasome activation was confirmed by using the specific NLRP3
188 inhibitor, MCC950, or the specific caspase-1 inhibitor, VX-765. The addition of these
189 inhibitors to PBMCs prior to their priming by LPS+CaCl₂ resulted in the reduction of
190 elevated IL-1 β secretion in all subjects except of one (Figure 3B, C). The control, Muckle-
191 Wells pediatric patient with a known pathogenic variant in NLRP3 (NM_004895.4
192 c.1224G>C (p.Met408Ile), showed similar results (Figure 3D). Finally, these results were
193 further statistically confirmed by pooling the three independent experiments and calculating
194 the fold of change (FC) of IL-1 β secretion between each treatment to the non-treated PBMCs
195 (Figure 3E).

196 To complement IL-1 β secretion measurement, we analyzed the expression and
197 cleavage of several NLRP3 inflammasome activation hallmarks: caspase-1, GSDMD, and IL-
198 1 β using immunoblot and specific antibodies. As can be seen in Figure 3G, pro-caspase-1,
199 pro-IL-1 β , and full-length GSDMD were detected in the PBMCs of NLRP3 variation carrier
200 (subject I4) prior to LPS stimulation whilst remaining at undetected levels in the healthy
201 control (subject no.2). Furthermore, in agreement with IL-1 β secretion phenotype, GSDMD
202 and caspase-1 in NLRP3 variation carrier PBMCs were detected in their activated (cleaved)
203 state (Figure 3D). Overall, these *ex-vivo* functional results suggest that c.1790G>A,
204 p.Ser597Asn is a gain-of-function mutation that results in a constitutively unique semi-
205 activated basal state of the NLRP3 inflammasome.

206

207 **Substantial hearing improvement in response to IL-1R antagonist treatment (Anakinra)**

208 The clinical presentation, family segregation of the novel variant, and evidence of
209 inflammasome hyper-activation in the above *ex-vivo* functional studies suggest that the novel
210 variant 001079821:c.1790G>A,p.Ser597Asn is a pathogenic gain-of-function mutation-
211 causing atypical CAPS phenotype, according to the Eurofever classification criteria [13].
212 Thus, we decided to treat the affected patients with an interleukin-1 receptor antagonist (IL-
213 1Ra) drug, which blocks IL-1 β activity. Therapy with IL-1Ra (Anakinra) was consequently
214 administered at an initial dose of 3 mg/kg (up to 100 mg) daily. Clinical follow-up included
215 clinical and hearing assessment as well as the measurement of inflammatory markers 1-3
216 months post-treatment initiation (Tables 2, 3). Audiometry reassessment was conducted one

217 and three months after treatment initiation. The three affected children showed rapid and
218 near-complete reversal of hearing impairment, and returned to near-normal hearing function
219 within 1-3 months (Figure 4). Among the three 2nd generation subjects, we observed minimal
220 asymmetrical improvement in hearing function (Figure 5). Although the grandmother (patient
221 I4) with the cochlear implant did not report any improvement in hearing function, she did
222 report a resolution of arthralgia within two weeks of treatment initiation. In addition, all her
223 initially slightly elevated inflammatory markers returned to normal within one month of
224 treatment (Table 2.).

225 No severe adverse reactions to Anakinra were reported.

226

227 **Discussion**

228 Gain-of-function mutations in the NLRP3 gene led to hyper-activation of the NLRP3
229 inflammasome, resulting in excessive secretion of inflammatory cytokines such as IL-1 β and
230 IL-18. Clinically these mutations cause a spectrum of autosomal-dominant systemic
231 autoinflammatory diseases known as CAPS/NLRP3-AIDs. In addition to the three classical
232 clinical subtypes of CAPS (NOMID, MWS, and FCAS), there have been a few reports of
233 NLRP3 missense variants associated with progressive sensorineural hearing loss as the
234 primary/sole clinical manifestation [5,6,14].

235 In this study, we presented family members spanning three generations with a novel
236 missense variant in the NLRP3 gene of unknown significance (NM 001079821:c.1790G>A,
237 p.Ser597Asn), with clinical features inconsistent with classical CAPS (i.e., past history of
238 PFAPA, sparse episodes of isolated fever, and nonspecific past history of arthralgia/arthritis).
239 Even though they did not meet the classification criteria for CAPS [13], the familial
240 genotype-phenotype segregation and potentially treatable hearing loss (autosomal dominant
241 progressive/rapid/mixed SNHL) led us to explore the suspected diagnosis of atypical CAPS.
242 Thus, in the hope of establishing the suspected diagnosis and enabling prompt initiation of
243 appropriate anti-IL-1 therapy, we conducted further clinical, imaging, and functional
244 inflammasome assessment.

245 Autosomal dominant progressive SNHL initially affected the high and ultrahigh
246 frequency range (as seen in pediatric patients III2 and III4) and progressed to severe
247 impairment involving lower frequencies also in adult patients (Figure 2). In addition to the
248 typical CAPS-associated bilateral progressive deterioration [15], some subjects suffered from
249 an atypical pattern of acute unilateral hearing loss (I4 and II6) (Figure 2). In the course of this
250 study, subject III2, a 5-10-year-old female who initially presented normal hearing function,
251 suffered from unilateral rapid sensorineural hearing deterioration that involved only the high-
252 ultrahigh ranges (Figure 2). It should be noted that she had no auditory complaints and was
253 diagnosed in her routine semiannual checkup which included these frequency ranges. To the
254 best of our knowledge, this is the first report of isolated acute hearing loss among CAPS
255 patients. Furthermore, the prompt initiation of Anakinra treatment in this patient, which led to
256 nearly complete resolution of SNHL (Figure 4), highlights the importance of both the routine
257 auditory evaluation of the high-ultrahigh ranges and rapid anti-IL-1 intervention treatment.

258 Interestingly, although the affected adults reported hearing impairment onset in their
259 early 20's, early symptomatic and asymptomatic changes in the high and ultrahigh-frequency
260 ranges were detected among the affected children as early as five years of age (Figure 2F-H).
261 This could be explained either by phenotypic progression over generations, increased
262 awareness of hearing impairment among family members, or merely thanks to early detection
263 in semiannual hearing function tests starting from infancy that specifically included the high
264 and ultrahigh-frequency ranges. Nevertheless, regardless of the reason for this early
265 detection, this further supports the importance of adding these frequency ranges to the regular
266 auditory evaluation of these patients.

267 In addition to hearing impairment, further clinical evaluation of known carriers
268 revealed a high prevalence of PFAPA in childhood among 4/13 carriers. This is an interesting
269 finding, as although the pathogenesis of PFAPA syndrome is unknown, it has previously
270 been linked to inflammasome hyper-activation [16].

271 Surprisingly, a magnetic resonance imaging (MRI) of the temporal bone did not
272 reveal any signs of cochlear inflammation among affected family members. However, it
273 should be noted that the grandmother (I4) did not complete an MRI due to cochlear implant
274 incompatibility. In addition, as recently described [17], cochlear MRI may be normal in some
275 CAPS patients with SNHL and is considered a positive predictive factor for clinical response
276 to Anakinra treatment.

277 As described, in order to further establish the diagnosis, we conducted functional
278 assessment of the NLRP3 inflammasome activity in PBMCs of carriers vs. healthy family
279 members. As expected, secreted IL-1 β levels and cleavage of GSDMD and caspase-1 were
280 substantially and significantly higher among carriers vs. healthy controls following priming
281 without the secondary and specific activation of the NLRP3 inflammasome. These results are
282 consistent with the dogma that in cases of gain-of-function mutations in NLR as NLRP3, IL-
283 1 β secretion can be induced by priming signals such as LPS.[18,19]

284 The response to Anakinra treatment was dramatic, especially among the 3rd generation
285 pediatric patients. The three affected children showed near-complete reversal of hearing
286 impairment and returned to near normal hearing function within 1-3 months (Figures 4, 6).
287 Not surprisingly, the grandmother (I4), who presented the most severe and prolonged
288 symptoms, did not report improvement in hearing function, probably as a result of
289 irreversible cochlear damage on the right and the presence of the cochlear implant on the left.
290 However, she did report a complete resolution of arthralgia within two weeks, and
291 inflammatory markers normalized within a month of treatment. 2nd generation patients (II2,
292 II4, and II6) who suffered from severe and prolonged hearing impairment (threshold below
293 60dB in some frequencies) (Figures 2C-E) still gained an overall slight improvement in
294 hearing function (Figures 5-6). Although this could be a result of irreversible cochlear
295 damage after years of untreated cochlear inflammation, it could also be explained by the
296 relatively low initial Anakinra dosage (100 ng per day). For this reason, we are currently
297 considering increasing the daily dosage. In line with our observation, a recent study [17]
298 categorized seventeen families diagnosed with either CAPS or atypical CAPS according to
299 the severity of hearing impairment, MRI findings/absence of evidence of cochlear

300 inflammation, and evidence of NLRP3 hyper-activation (according to an in vitro LPS
301 stimulation test). They suggested that a hearing function threshold below 60dB prior to
302 Anakinra (Anti-IL-1) treatment and cochlear enhancement on brain MRI are related to poor
303 audiological prognosis and responsiveness to Anakinra therapy.

304 In summary, our findings highlight the crucial role of early diagnosis and treatment
305 with an anti-IL-1 agent in reversing cochlear damage. Furthermore, our results suggest that
306 high and ultrahigh frequency ranges should be included in the auditory assessment to enable
307 early detection of subclinical SNHL. Finally, functional inflammasome assessment can
308 establish the diagnosis in inconclusive cases.
309

310 **Material and methods**

311 **Patients**

312 A family of Jewish Ashkenazi descent initially presented with autosomal dominant
313 bilateral SNHL with a progressive/rapid/mixed deterioration pattern. The hearing impairment
314 initially affected high/ultra-high frequencies as an isolated presentation or was accompanied
315 by nonspecific systemic signs and symptoms inconsistent with typical CAPS (i.e., sporadic
316 episodes of fever, arthritis/arhralgia, or PFAPA (periodic fever, aphthous stomatitis,
317 pharyngitis, adenitis)). All SNHL family members were carriers of a novel missense mutation
318 in NLRP3 of unknown significance and did not fulfill CAPS classification criteria [13]
319 (Figure 1A, Table 1). We assessed ten known carriers spanning three generations who were
320 found to be carriers of the NLRP3 variant, seven with impaired and three with normal hearing
321 function. Age at study initiation ranged from 2-70 years. The control group consisted of five
322 healthy family members who were matched by age group. Our study group also included one
323 unrelated 5-10-year-old patient (P 2.1) who presented with classical signs and symptoms of
324 Muckle-Wells and is a carrier of a known heterozygous pathogenic variant (NM_004895.4)
325 in NLRP3. This patient served as a positive control for inflammasome hyperactivation in the
326 study.

327

328 **Clinical and genetic evaluation**

329 Affected family members underwent clinical evaluation by a clinical rheumatologist,
330 otorhinolaryngologist, and a clinical geneticist. Medical records and past audiometry tests
331 were reviewed. Clinical evaluation and peripheral blood inflammatory markers were obtained
332 for all symptomatic patients before and after interleukin-1 receptor antagonist (IL-1Ra)
333 (anakinra) treatment initiation. Pure-tone audiometry was performed per test eligibility (age-
334 dependent) on all known carriers, of whom seven were symptomatic (I4, II2, II4, II6, III2,
335 III4, III5). The ultra-high frequency range (8KHz – 16KHz) was also evaluated in patients
336 III2, III4, III5, III7, and III9. Follow-up audiometry was conducted on all treated patients.

337 High-resolution magnetic resonance imaging (MRI) scans of the temporal bones were
338 performed with a Philips Ingenia 3 Tesla system (Philips Healthcare). The scans included an
339 axial heavily T2 weighted sequence (DRIVE) and a T1 weighted sequence. Following the
340 injection of Gadolinium-based contrast media, a 3D sequence (3D FLAIR or 3D T1 Dixon)
341 was performed.

342

343 ***Ex-vivo* functional assessment of NLRP3 inflammasome activity**

344 Peripheral blood samples were drawn into an EDTA tube from a total of 15 subjects
345 (11 novel variant carriers, one Muckle-Wells patient, and three age-matched healthy family
346 members as controls). PBMCs were immediately isolated (up to two hours from collection)
347 as done previously [20]. See Supplementary Data for further details. Approximately 10^5
348 PBMCs were seeded in each well of the 96 well plate and LPS was added to indicate wells
349 for three hours. Where indicated, caspase-1 inhibitor, Vx765, or NLRP3 inhibitor, MCC950,
350 were added 30 minutes prior to CaCl_2 addition. Cell supernatants and cell lysates were
351 collected three hours later for further analysis. Supernatants were analyzed for IL-1 β
352 secretion using ELISA kit (Invitrogen Waltham, Massachusetts, USA). Cell lysates were

353 analyzed for cleaved human-IL-1 β , cleaved caspase-1, and cleaved GSDMD using
354 immunoblot and specific antibodies. See further details in supplementary data.

355 **Statistics**

356 Statistical comparisons in the *ex-vivo* experiments between the different treatments
357 were performed using multiple unpaired t-tests. A comparison of hearing before and after
358 Anakinra treatment was performed using RM two-way ANOVA. P values <0.05 were
359 considered statistically significant.

360 **Data analysis**

361 Data were calculated using GraphPad Prism 9, and details can be found in the figure
362 legends.

363

364 **Data availability statement**

365 The original contributions presented in the study are included in the
366 article/Supplementary Material. Further inquiries can be directed to the corresponding
367 authors.

368

369 **Ethics statement**

370 All experiments in this study were reviewed and approved by the ethics committee
371 (RMC0941-20) and performed according to the Declaration of Helsinki. Prospective and
372 retrospective reviews of medical history, laboratory and imaging results, rheumatologic
373 evaluations, and laboratory tests were performed after informed consent. Written informed
374 consent was obtained from adult subjects and from both parents of minor subjects.

375

376 **Author contributions**

377 BM initiated and designed the study concept and coordinated the multidisciplinary
378 assessment of patients; BM, CH, and GM designed the experiments; BM, and CH performed
379 experiments; SM, RE, and HO performed the clinical hearing evaluation; KL performed the
380 brain image analysis; KN, SE, and ON coordinated and conducted clinical-genetic
381 assessments; AG, DR, LG, BM, and HL, performed the clinical evaluation and management;
382 BM, wrote the original draft; All authors wrote and edited the manuscript. HL, and GM
383 contributed to the study conception and design and supervised the work.

384

385 **Funding**

386 GM acknowledges funding from US-BSF grant #2017176, ISF grant #2174/22.

387 **Conflict of interest**

388 The authors declare that the research was conducted in the absence of any commercial
389 or financial relationships that could be construed as a potential conflict of interest.

390

391 **Acknowledgments**

392 First and foremost, we would like to extend our thanks and appreciation to all family
393 members who participated in this study. We would also like to express gratitude to our
394 colleagues Ivona Aksentijevich, Kalpana Manthiram, and Amanda Ombrello from the
395 National Institute of Health; and Ziv Erlich from Tel Aviv University for their assistance
396 throughout.

397

398 **Contribution to the field statement**

399 Cryopyrin-associated periodic syndromes (CAPS) are a spectrum of rare auto-
400 inflammatory diseases caused by gain-of-function mutations in the NLRP3 gene, resulting in
401 inflammasome hyper-activation and subsequent uncontrolled release of Interleukin-1 β (IL-
402 1 β). Many patients with CAPS develop progressive sensorineural hearing loss (SNHL) due to
403 cochlear auto-inflammation, which in rare cases may be the sole or main manifestation. In
404 this study, we establish the suspected diagnosis of CAPS in a family presenting autosomal
405 dominant SNHL with progressive/acute deterioration and a novel missense variant in the
406 NLRP3 gene of unknown significance (NM_001079821:c.1790G>A, p.Ser597Asn), by
407 conducting *ex-vivo* functional assessment of the NLRP3 inflammasome. Subsequent
408 administration of anti-IL-1 therapy resulted in a substantial clinical improvement especially
409 among pediatric patients who exhibited near resolution of hearing impairment within a few
410 months of treatment. Our findings highlight the crucial role of early diagnosis and treatment
411 with an anti-IL-1 agent in reversing cochlear damage. Furthermore, our results suggest that
412 high and ultrahigh frequency ranges need to be included in the auditory assessment to enable
413 early detection of subclinical SNHL. Finally, incorporating functional inflammasome
414 assessment as part of the clinical evaluation could establish the diagnosis in inconclusive
415 cases.

416

417 **References**

- 418 1. Schroder K, Tschopp J. The Inflammasomes. *Cell*. 2010;140:821–32.
- 419 2. Broide DH, Hoffman HM, Mueller JL, Broide DH. Mutation of a new gene encoding a
420 putative pyrin-like protein causes familial cold autoinflammatory syndrome and Muckle–
421 Wells syndrome. *Nat Genet* [Internet]. 2001 [cited 2021 Oct 4];29:301–5. Available from:
422 [https://brmc.tdnetsdiscover.com/results/mendeleycallback?token=ui.export.mendeley.f84a5b1](https://brmc.tdnetsdiscover.com/results/mendeleycallback?token=ui.export.mendeley.f84a5b1b-d635-42da-a44e-5e813cdd9066&returnUrl=/discover/result?logSearchID=77717782&pubid=7156-oai%3Apubmedcentral.nih.gov%3A4322000&pubid=7902-info%3Adoi%2F10.1038%252Fng756&pubid=6057-medline%3A11687797)
423 [b-d635-42da-a44e-](https://brmc.tdnetsdiscover.com/results/mendeleycallback?token=ui.export.mendeley.f84a5b1b-d635-42da-a44e-5e813cdd9066&returnUrl=/discover/result?logSearchID=77717782&pubid=7156-oai%3Apubmedcentral.nih.gov%3A4322000&pubid=7902-info%3Adoi%2F10.1038%252Fng756&pubid=6057-medline%3A11687797)
424 [5e813cdd9066&returnUrl=/discover/result?logSearchID=77717782&pubid=7156-](https://brmc.tdnetsdiscover.com/results/mendeleycallback?token=ui.export.mendeley.f84a5b1b-d635-42da-a44e-5e813cdd9066&returnUrl=/discover/result?logSearchID=77717782&pubid=7156-oai%3Apubmedcentral.nih.gov%3A4322000&pubid=7902-info%3Adoi%2F10.1038%252Fng756&pubid=6057-medline%3A11687797)
425 [oai%3Apubmedcentral.nih.gov%3A4322000&pubid=7902-](https://brmc.tdnetsdiscover.com/results/mendeleycallback?token=ui.export.mendeley.f84a5b1b-d635-42da-a44e-5e813cdd9066&returnUrl=/discover/result?logSearchID=77717782&pubid=7156-oai%3Apubmedcentral.nih.gov%3A4322000&pubid=7902-info%3Adoi%2F10.1038%252Fng756&pubid=6057-medline%3A11687797)
426 [info%3Adoi%2F10.1038%252Fng756&pubid=6057-medline%3A11687797](https://brmc.tdnetsdiscover.com/results/mendeleycallback?token=ui.export.mendeley.f84a5b1b-d635-42da-a44e-5e813cdd9066&returnUrl=/discover/result?logSearchID=77717782&pubid=7156-oai%3Apubmedcentral.nih.gov%3A4322000&pubid=7902-info%3Adoi%2F10.1038%252Fng756&pubid=6057-medline%3A11687797)
- 427 3. Hoffman HM, Booshehri L, Hoffman H. CAPS and NLRP3. *J Clin Immunol* [Internet].
428 2019 [cited 2020 Oct 29];39:277–86. Available from:
429 [https://brmc.tdnetsdiscover.com/results/mendeleycallback?token=ui.export.mendeley.ef50a8d](https://brmc.tdnetsdiscover.com/results/mendeleycallback?token=ui.export.mendeley.ef50a8d9-50fa-4bb2-bd54-1e67a1880575&returnUrl=/discover/result?logSearchID=56293390&pubid=7109-springer%3A10.1007%2Fs10875-019-00638-z&pubid=7902-info%3Adoi%2F10.1007%252Fs10875-019-00638-z&pubid=6057-medline%3A31077002)
430 [9-50fa-4bb2-bd54-](https://brmc.tdnetsdiscover.com/results/mendeleycallback?token=ui.export.mendeley.ef50a8d9-50fa-4bb2-bd54-1e67a1880575&returnUrl=/discover/result?logSearchID=56293390&pubid=7109-springer%3A10.1007%2Fs10875-019-00638-z&pubid=7902-info%3Adoi%2F10.1007%252Fs10875-019-00638-z&pubid=6057-medline%3A31077002)
431 [1e67a1880575&returnUrl=/discover/result?logSearchID=56293390&pubid=7109-](https://brmc.tdnetsdiscover.com/results/mendeleycallback?token=ui.export.mendeley.ef50a8d9-50fa-4bb2-bd54-1e67a1880575&returnUrl=/discover/result?logSearchID=56293390&pubid=7109-springer%3A10.1007%2Fs10875-019-00638-z&pubid=7902-info%3Adoi%2F10.1007%252Fs10875-019-00638-z&pubid=6057-medline%3A31077002)
432 [springer%3A10.1007%2Fs10875-019-00638-z&pubid=7902-](https://brmc.tdnetsdiscover.com/results/mendeleycallback?token=ui.export.mendeley.ef50a8d9-50fa-4bb2-bd54-1e67a1880575&returnUrl=/discover/result?logSearchID=56293390&pubid=7109-springer%3A10.1007%2Fs10875-019-00638-z&pubid=7902-info%3Adoi%2F10.1007%252Fs10875-019-00638-z&pubid=6057-medline%3A31077002)
433 [info%3Adoi%2F10.1007%252Fs10875-019-00638-z&pubid=6057-medline%3A31077002](https://brmc.tdnetsdiscover.com/results/mendeleycallback?token=ui.export.mendeley.ef50a8d9-50fa-4bb2-bd54-1e67a1880575&returnUrl=/discover/result?logSearchID=56293390&pubid=7109-springer%3A10.1007%2Fs10875-019-00638-z&pubid=7902-info%3Adoi%2F10.1007%252Fs10875-019-00638-z&pubid=6057-medline%3A31077002)
- 434 4. Yamada S, Kita J, Shinmura D, Nakamura Y, Sahara S, Misawa K, et al. Update on
435 Findings about Sudden Sensorineural Hearing Loss and Insight into Its Pathogenesis. *J Clin*
436 *Med*. MDPI AG; 2022;11:6387.
- 437 5. Oziębło D, Leja ML, Jeznach A, Orzechowska M, Skirecki T, Więsik-Szewczyk E, et al.
438 Hearing Loss as the Main Clinical Presentation in NLRP3-Associated Autoinflammatory
439 Disease. *Front Immunol*. Frontiers Media S.A.; 2022;13.
- 440 6. Nakanishi H, Kawashima Y, Kurima K, Muskett JA, Kim HJ, Brewer CC, et al. Gradual
441 Symmetric Progression of DFNA34 Hearing Loss Caused by an NLRP3 Mutation and
442 Cochlear Autoinflammation. *Otology and Neurotology*. 2018;39:e181–5.
- 443 7. Schroder K, Tschopp J. The Inflammasomes. *Cell*. Elsevier B.V.; 2010. p. 821–32.
- 444 8. Lamkanfi M, Dixit VM. Mechanisms and functions of inflammasomes. *Cell*. Elsevier
445 B.V.; 2014. p. 1013–22.
- 446 9. Erlich Z, Shlomovitz I, Edry-Botzer L, Cohen H, Frank D, Wang H, et al. Macrophages,
447 rather than DCs, are responsible for inflammasome activity in the GM-CSF BMDC model.
448 *Nat Immunol*. Nature Research; 2019. p. 397–406.
- 449 10. He WT, Wan H, Hu L, Chen P, Wang X, Huang Z, et al. Gasdermin D is an executor of
450 pyroptosis and required for interleukin-1 β secretion. *Cell Res*. Nature Publishing Group;
451 2015;25:1285–98.
- 452 11. Kanariou M, Dracou C, Spanou K, Möller J, Rösen-Wolff A, Schuster V, et al. Twenty
453 year follow up of a patient with a new de-novo NLRP3 mutation (S595G) and CINCA
454 syndrome. *Klin Padiatr*. 2009;221:379–81.

- 455 12. Li C, Tan X, Zhang J, Li S, Mo W, Han T, et al. Gene mutations and clinical phenotypes
456 in 15 Chinese children with cryopyrin-associated periodic syndrome (CAPS). *Sci China Life*
457 *Sci. Science in China Press*; 2017;60:1436–44.
- 458 13. Gattorno M, Hofer M, Federici S, Vanoni F, Bovis F, Aksentijevich I, et al. Classification
459 criteria for autoinflammatory recurrent fevers. *Ann Rheum Dis. BMJ Publishing Group*;
460 2019;78:1025–32.
- 461 14. Nakanishi H, Prakash P, Ito T, Kim HJ, Brewer CC, Harrow D, et al. Genetic Hearing
462 Loss Associated With Autoinflammation. *Front Neurol.* 2020;11:1–7.
- 463 15. Nakanishi H, Yamada S, Kita J, Shinmura D, Hosokawa K, Sahara S, et al. Auditory and
464 Vestibular Characteristics of NLRP3 Inflammasome Related Autoinflammatory Disorders:
465 Monogenic Hearing Loss Can Be Improved by Anti-interleukin-1 Therapy. *Front Neurol.*
466 *Frontiers Media S.A.*; 2022.
- 467 16. Kolly L, Busso N, Von Scheven-Gete A, Bagnoud N, Moix I, Holzinger D, et al. Periodic
468 fever, aphthous stomatitis, pharyngitis, cervical adenitis syndrome is linked to dysregulated
469 monocyte IL-1 β production. *Journal of Allergy and Clinical Immunology.* 2013;131:1635–
470 43.
- 471 17. Kim BJ, Kim YH, Lee S, Han JH, Lee S-Y, Seong J, et al. Otological aspects of NLRP3-
472 related autoinflammatory disorder focusing on the responsiveness to anakinra.
473 *Rheumatology.* 2020;1–10.
- 474 18. Nakanishi H, Kawashima Y, Kurima K, Chae JJ, Ross AM, Pinto-Patarroyo G, et al.
475 NLRP3 mutation and cochlear autoinflammation cause syndromic and nonsyndromic hearing
476 loss DFNA34 responsive to anakinra therapy. *Proc Natl Acad Sci U S A.* 2017;114:E7766–
477 75.
- 478 19. Masters SL, Gerlic M, Metcalf D, Preston S, Pellegrini M, O'Donnell JA, et al. NLRP1
479 Inflammasome Activation Induces Pyroptosis of Hematopoietic Progenitor Cells. *Immunity.*
480 2012;37:1009–23.
- 481 20. Cohen H, Baram N, Edry-Botzer L, Munitz A, Salomon D, Gerlic M. *Vibrio* pore-
482 forming leukocidin activates pyroptotic cell death via the NLRP3 inflammasome. *Emerg*
483 *Microbes Infect.* Taylor and Francis Ltd.; 2020;9:278–90.
- 484
- 485

486 **Tables**

487 Table 1. Clinical characteristics of family members with sensorineural hearing loss

Subject	Age	Sex	Periodic fever	Musculoskeletal	Urticaria l Rash	Eye involvement	Cochlear Inflammation in MRI	Other****
I4	>70	F	No	Recurrent short episodes of arthritis/arthralgia	No	No	Not conducted	Rheumatic fever with carditis, ITP*
II2	41-45	F	No	Recurrent short episodes of arthritis/arthralgia as an adolescent post pharyngitis episode	No	No	No	Suspected Rheumatic fever as a child (no carditis)
II4	35-40	M	PFAPA** - like resolved	No	No	No	No	
II6	35-40	M	No	No	No	No	No	
III2	6-10	F	No	No	No	No	No	
III4	6-10	M	PFAPA- like resolved	No	No	No	No	
III5	10-15	F	PFAPA- like resolved	No	No	No	No	

* ITP- Idiopathic Thrombocytopenic Purpura ** PFAPA- periodic fever, aphthous stomatitis, pharyngitis, adenitis *** Other autoimmune phenomena

488

489 Table 2. Inflammatory markers levels pre- and post- Anakinra

Patient	<u>Prior to Anakinra Treatment</u>				<u>After 3 months of Anakinra Treatment</u>			
	WBC	ESR	CRP	SAA	WBC	ESR	CRP	SAA
I4	7.2	36	0.84	5.3	4.42	8	0.16	2.8
II2	7.54	28 (old)	0.56	22.7	5	24	<0.05	4.7
II4	6.9	15	0.25	6.2	7.12	10*	0.09	X
II6	7	12	0.52	5.5	7	5	0.07	X
III2	11.13	19	0.26	4-12.6 **	7.88*	21*	0.43*	X
III4	10.4	14	1.19	<0.82	5.2	13	0.6	3
III5	6.6	15	0.64	3.3	5.71	5	<0.05	1

* 1 month after Anakinra initiation ** Original levels of SAA were undetectable. However, SAA levels were measured and elevated during sudden hearing loss episode. White blood cells (WBC) K/micl, ESR- mm/1hr, CRP- C reactive protein mg/dL, SAA - Serum Amyloid A mg/l (range 0.0-6.4)

490

491 Table 3. SNHL features and response to Anakinra treatment

Patient	Description	Episode of Unilateral Hearing Loss	Age At Hearing Impairment Onset (years)	Age at Treatment Initiation	Duration of Hearing Impairment Prior to Anakinra Initiation (years)	Response to Treatment (~ 3 months)
I4	Severe bilateral progressive SNHL	Yes	16-20	>70	~50	No improvement
II2	Severe-moderate bilateral progressive SNHL	No	16-20	41-45	~20	Mild improvement (asymmetrical)
II4	Severe-moderate bilateral progressive SNHL	No	16-20	35-40	~20	Mild improvement (asymmetrical)
II6	Severe-moderate bilateral progressive SNHL	Yes	16-20	35-40	~20	Minimal-no improvement (asymmetrical)
III2	Moderate unilateral sudden HL	Yes	6-10	6-10	0	Near-complete resolution of HL
III4	Mild-moderate bilateral progressive SNHL	No	6-10	6-10	3	Complete resolution of HL
III5	Moderate-severe bilateral progressive SNHL	No	6-10	11-15	6	Near-complete resolution of HL

HL- Hearing Loss, SNHL- Sensorineural Hearing Loss

492

493 **Figures**

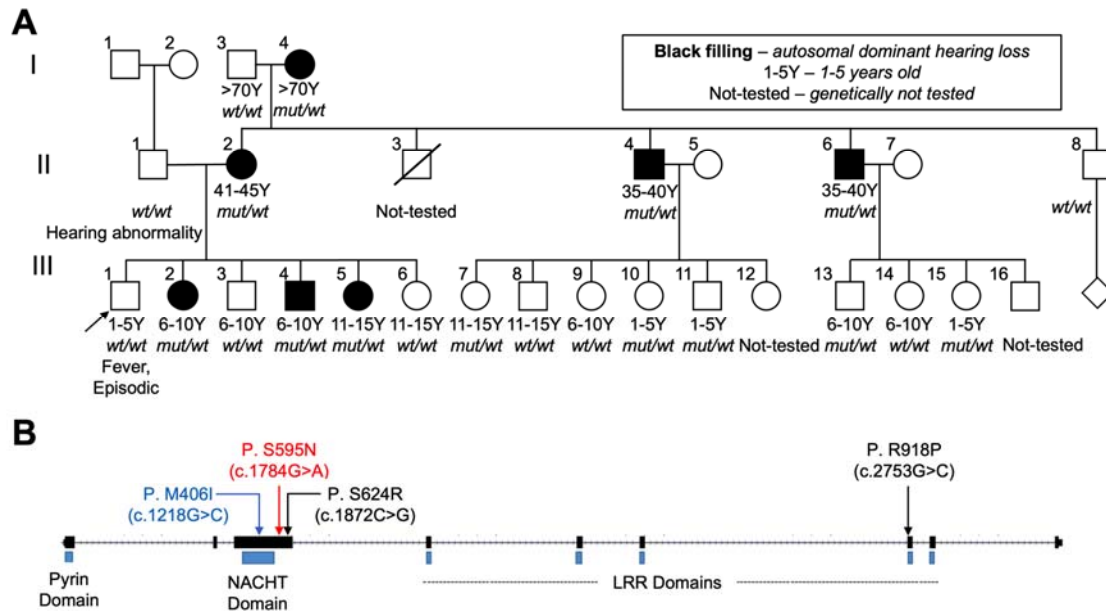

494

495 **Figure 1. Family Pedigree and genetic information**

496 (A) Pedigree of the investigated family. Subjects with autosomal dominant hearing loss are
 497 represented in green. Asymptomatic carriers and healthy family members are represented in
 498 white. Carrier status is indicated below each subject. The proband (III1) is indicated by an
 499 arrow. Pedigree was created using the Invitae family history tool (Invitae Corporation, San
 500 Francisco, California). (B) **Schematic view of the NLRP3 gene:** Figure adapted from UCSC
 501 genome browser, based on transcript NM_001079821.3. The figure shows only coding exons.
 502 Domain locations according to UniProt track (<https://www.uniprot.org/>) in UCSC genome
 503 browser (<https://genome.ucsc.edu/>). Variants p.Ser595Asn and p.Met406Ile, reported in this
 504 paper, are colored in red and blue, respectively. In black, previously reported variants
 505 p.Ser624Arg and p.Arg918Pro are associated with syndromic/nonsyndromic hearing loss as
 506 the primary presentation of CAPS [5,18]

507

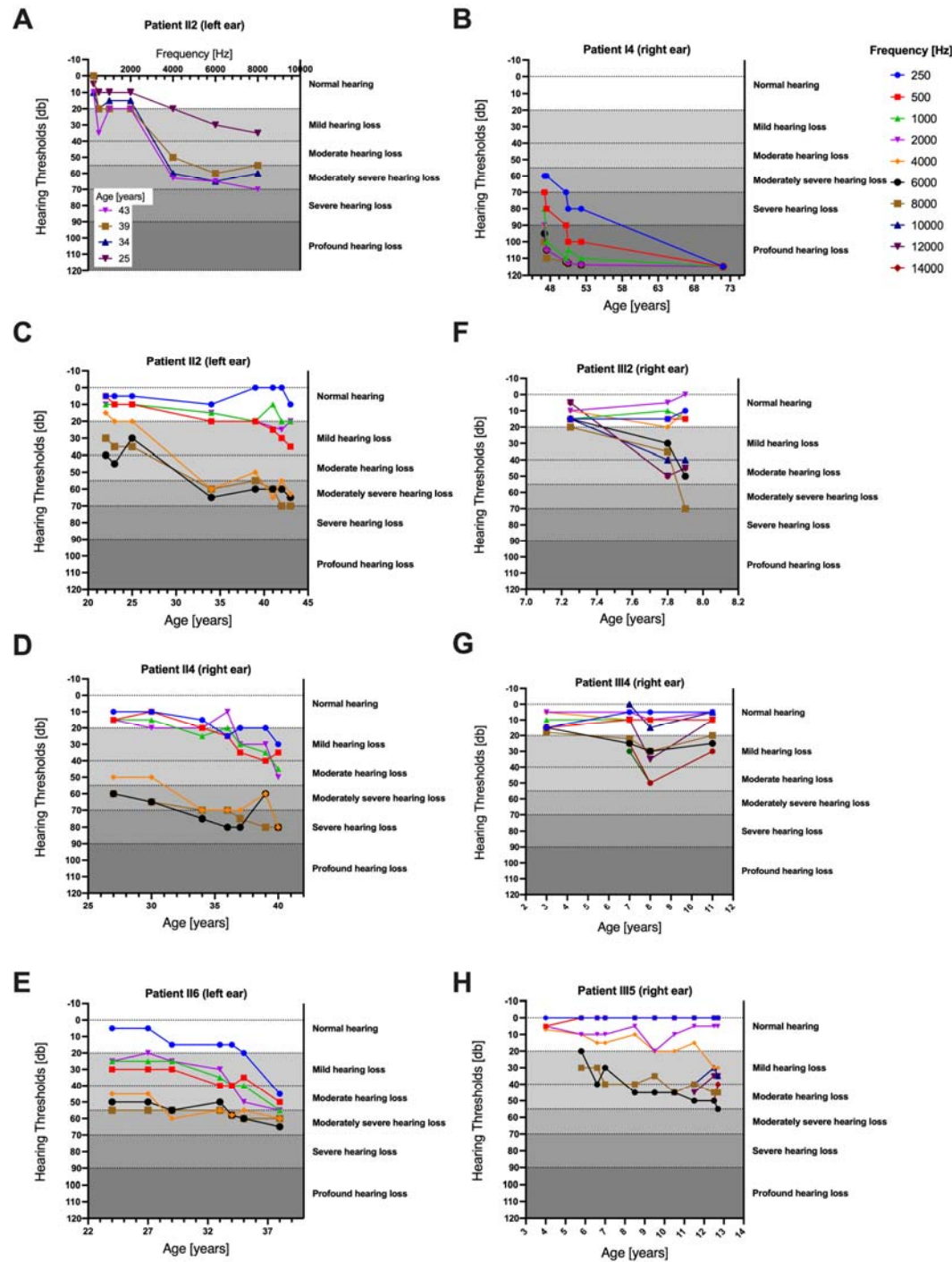

508

509 **Figure 2. Hearing loss over time in symptomatic patients**

510 Air conduction hearing thresholds in the better performing ear (aside from patient III4 who
 511 suffered from unilateral HL) depicting hearing deterioration over time, prior to Anakinra
 512 treatment. Patient identification number is shown on the top of each panel. (A) The Y axis
 513 represents hearing threshold level [dB] and the X axis tested frequency (kHz). (B-H) The Y
 514 axis represents hearing threshold level [dB] and the X axis age of patient (years). Each graph
 515 (in different colors) represents a different tested frequency (kHz).

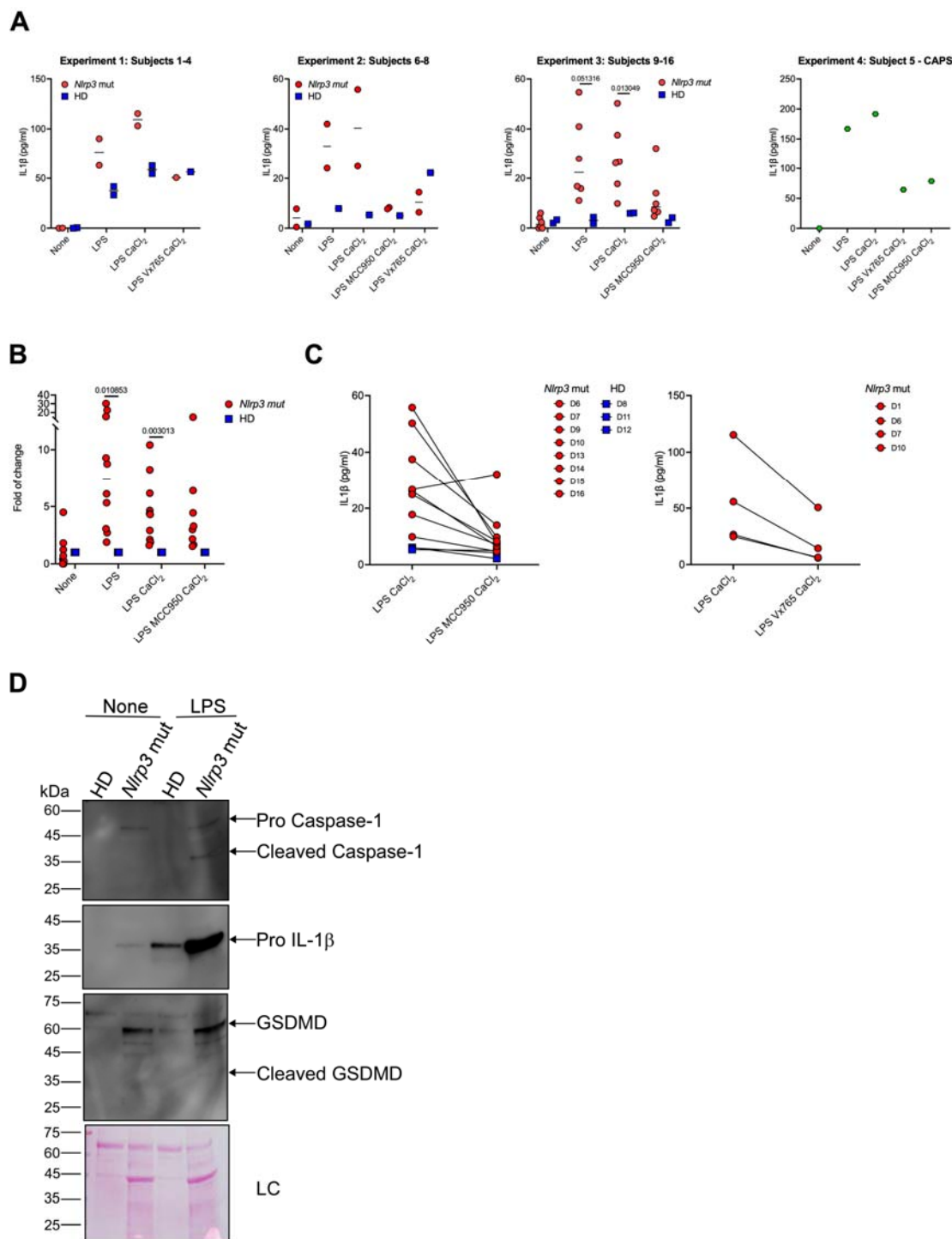

516

517 **Figure 3 Ex-vivo functional assessment of NLRP3 activity**

518 Approximately 10^5 PBMCs were seeded into 96-wells plate (D1-D4) or 10^6 PBMCs were
 519 seeded into 24-wells plate (D5-D16). Indicated wells were primed with lipopolysaccharides
 520 (LPS) (1 $\mu\text{g}/\text{mL}$) 3 hours prior to the experiment. Where indicated, MCC950 (2 μM) or
 521 Vx765 (25 μM) were added 30 minutes prior to the addition of CaCl_2 (1 mM). (A) Cell

522 supernatants from each experiment described above were collected 3 hours after CaCl_2
523 addition or 6 hours after LPS addition. IL-1 β secretion was measured using commercial
524 ELISA kit. (B) Fold of change (FC) of IL-1 β secreted from NLRP3 variant carriers PBMCs
525 compared to internal healthy control of the same experiment. (C) Change in IL-1 β secretion
526 before and after MCC950 or Vx756 addition. (D) Caspase-1, gasdermin D (GSDMD), and
527 IL-1 β were detected in PBMC lysate by immunoblotting. Statistical comparisons in (B)
528 between the NLRP3 variant carriers and healthy controls, were performed using multiple
529 unpaired t-tests, $P < 0.05$. In (D) arrows denote the expected.

530

531

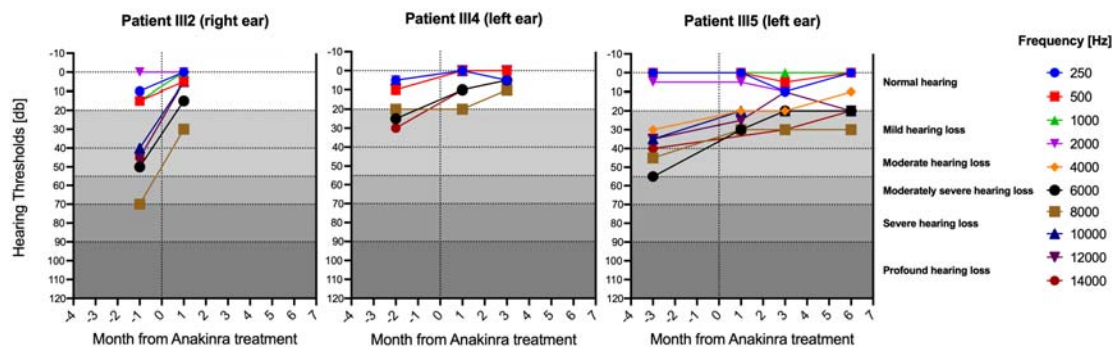

532

533 **Figure 4. Anakinra restores hearing loss in pediatric symptomatic patients**

534 Air conduction hearing thresholds depicting dynamics in hearing function over time, in
535 response to Anakinra treatment. Patient identification number is shown on the top of each
536 panel. The Y axis represents hearing threshold level [dB] and the X axis time from treatment
537 initiation (months). Each graph (in different colors) represents a different tested frequency
538 (kHz).

539

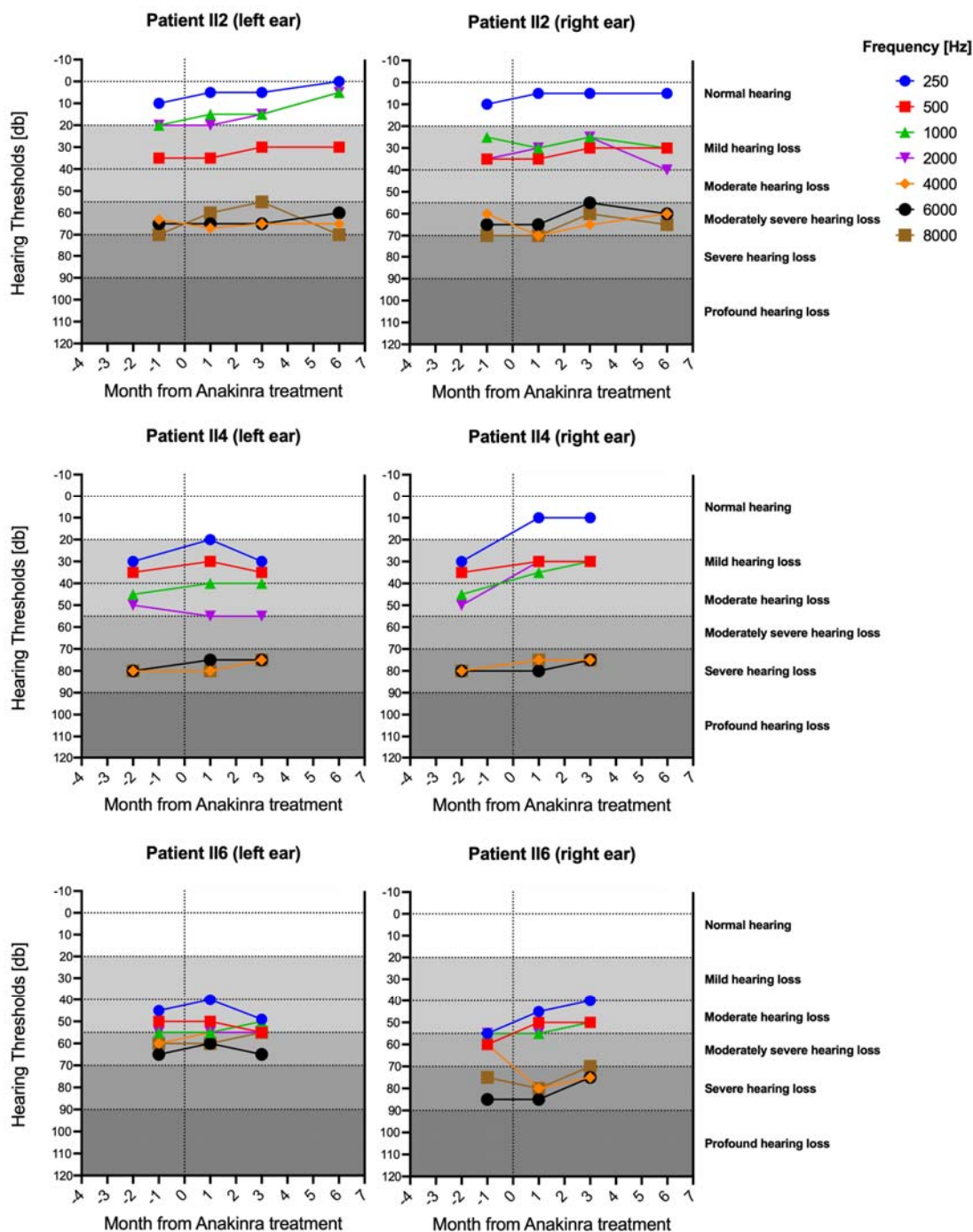

540

541 **Figure 5. Anakinra slightly improves hearing loss in adult symptomatic patients**

542 Air conduction hearing thresholds depicting dynamics in hearing function over time, in
 543 response to Anakinra treatment. Patient identification number is shown on the top of each
 544 panel. The Y axis represents hearing threshold level [dB] and the X axis time from treatment
 545 initiation (months). Each graph (in different colors) represents a different tested frequency
 546 (kHz).

547

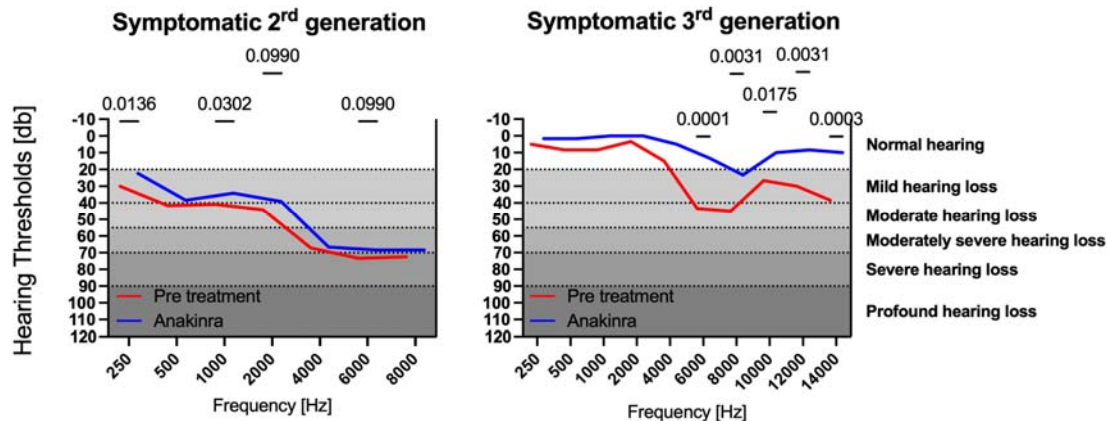

548

549 **Figure 6. Comparison of hearing loss Anakinra restoration in adults and pediatric**
550 **symptomatic patients**

551 Air conduction hearing thresholds representing dynamics of hearing function one month after
552 initiation of Anakinra treatment in 2nd (N=3, both ears were tested) and 3rd (N=3, one ear, the
553 affected ear was tested) generation patients (left and right panel, respectively). Generation
554 specified on the top of each panel. The Y axis represents the hearing threshold level [dB], and
555 the X axis tests frequency (kHz). Averages of pre-treatment is represented in red and post-
556 treatment in blue. In the Statistical comparisons between the pre- and post-treatment were
557 performed using two-way ANOVA (Fisher's LSD test), Significant ($P<0.05$) is shown.

558

559 **Supplemental material**

560 **Peripheral blood mononuclear cells (PBMCs) isolation**

561 PBMCs were isolated from peripheral venous blood samples freshly drawn from subjects 1-
562 16. Briefly, 10-30 ml of peripheral blood were collected and loaded on Histopaque-1077
563 (Sigma Aldrich 10771). Cells were centrifuged for 30 min at 400 g at 24°C. Cells from the
564 interphase were collected and washed with PBS. Samples of the cells were then stained for
565 flow cytometry to determine the percentage and concentration of monocytes, before they
566 were seeded in a 96-wells plate or a 24-wells plate at a final concentration of 10⁶
567 monocytes/ml, in DMEM supplemented with 10% heat-inactivated fetal bovine serum (FBS)
568 (Gibco, 10270106). After 18 h, the wells were washed three times to remove non-adherent
569 cells and medium was replaced with DMEM supplemented with 1% FBS. Cells were treated
570 with 1ug/mL ultrapure LPS. After 3 hours of LPS treatment, 2 ug/mL MCC950 or 25 µM
571 Vx765 were added to selected wells for 30 minutes prior to adding 1mM CaCl₂ for 3 hours.
572 After 3 hours cell supernatants and cell lysates were collected for further analysis by ELISA
573 or immunoblot, respectively. Experiments were performed according to the guidelines of the
574 Institute's Helsinki Ethics Committee.

575 **Immunoblot analysis of proteins**

576 Cells were collected and centrifuged for five minutes at 400xg in order to separate them from
577 the supernatant. Next, the cells were lysed by using RIPA buffer in the presence of protease
578 inhibitors at 4°C for 15 min. Lysed cells were loaded onto any kD gradient Criterion TGX-
579 Free precast gels (Bio-Rad, Hercules, California, USA). Proteins were transferred onto a
580 nitrocellulose membrane (Bio-Rad), and Ponceau S staining was performed routinely to
581 evaluate the loading accuracy. Membranes were blocked with 5% (w/v) skim milk in TBS for
582 1–2 h, and then probed overnight with primary antibodies (all diluted 1:1000, unless noted
583 otherwise): pro and cleaved human-IL-1 β (R&D, AF-201-NA), pro and cleaved human
584 caspase-1 (Merck, 06-503-I), and pro and cleaved human-GSDMD (abcam, ab210070).
585 Relevant horseradish peroxidase-conjugated secondary antibodies were applied for at least 1
586 hour. Membranes were washed between antibody incubations four times in TBS containing
587 0.1% (v/v) Tween 20 (TBST). Antibodies were diluted in TBST containing 5% skim milk.
588 Immunoblots were developed using an ECL kit (Bio-Rad) in an ODYSSEY Fc (Li-COR,
589 Lincoln, Nebraska USA) equipped with Image Lab software. All images were cropped for
590 presentation. Full-size images will be presented upon request.

591 **Reagents**

592 Unless stated otherwise, all cell culture reagents were purchased from Biological
593 Industries, Beit-Haemek, Israel. Lipopolysaccharides (LPS) of Escherichia coli O111:B4
594 were purchased from Sigma-Aldrich (#L3024, Munich, Germany). Vx765 and MCC950 and
595 ELISA kit were purchased from Invitrogen (Waltham, Massachusetts, USA). HRP-
596 conjugated secondary antibodies were purchased from Jackson ImmunoResearch Labs (West
597 Grove, PA, USA).

598

599 **Supplemental Figures**

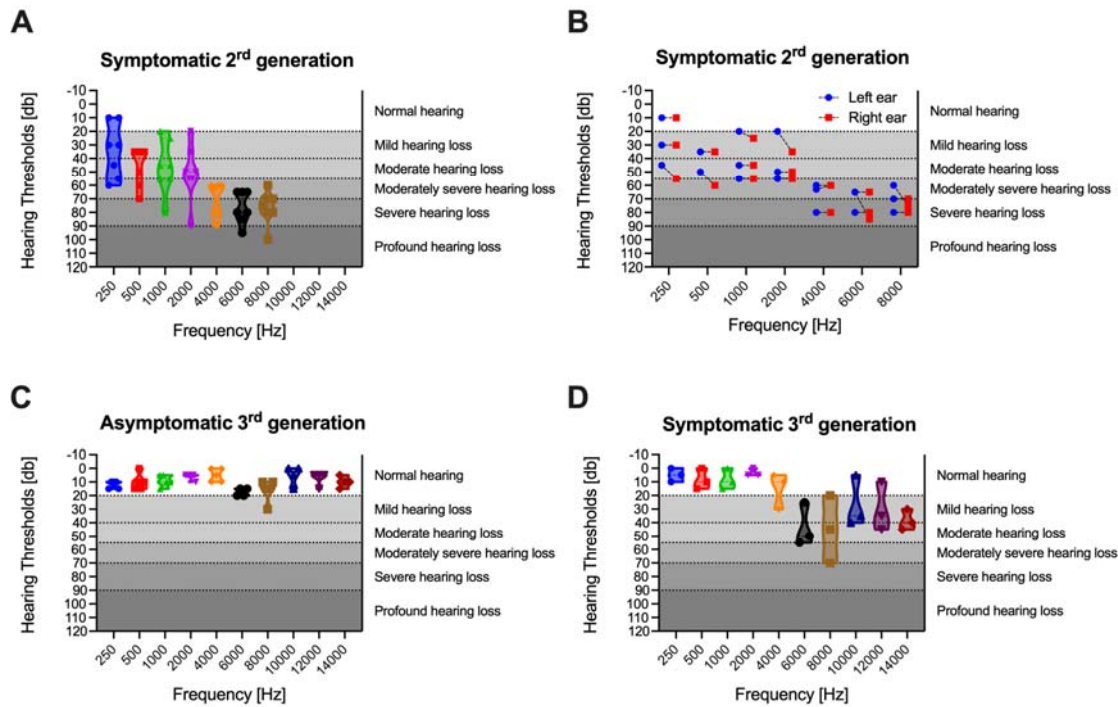

600

601 **Supplemental Figure 1. Hearing loss 2nd and 3rd generation patients**

602 Pooled same-generation auditory phenotypes based on generation and hearing loss status are
603 stated on the top of each panel. Although hearing loss severity per tested frequency varied
604 among patients, overall, the high-ultrahigh hearing range is most severely affected (panels A,
605 D).