

1        **Quantification of early nonpharmaceutical interventions aimed at slowing**  
2        **transmission of Coronavirus Disease 2019 in the Navajo Nation and**  
3        **surrounding states (Arizona, Colorado, New Mexico, and Utah)**

4        **Short Title:** The COVID-19 epidemics in the Navajo Nation and surrounding states

5        Ely F. Miller<sup>1</sup>, Jacob Neumann<sup>1#</sup>, Ye Chen<sup>2</sup>, Abhishek Mallela<sup>3†</sup>, Yen Ting Lin<sup>4</sup>, William S.

6        Hlavacek<sup>5</sup>, Richard G. Posner<sup>1\*</sup>

7        <sup>1</sup>Department of Biological Sciences, Northern Arizona University, Flagstaff, Arizona, United  
8        States of America

9        <sup>2</sup>Department of Mathematics and Statistics, Northern Arizona University, Flagstaff, Arizona,  
10        United States of America

11        <sup>3</sup>Department of Mathematics, University of California, Davis, California, United States of  
12        America

13        <sup>4</sup>Computer, Computational, and Statistical Sciences Division and Center for Nonlinear Studies,  
14        Los Alamos National Laboratory, Los Alamos, New Mexico, United States of America

15        <sup>5</sup>Theoretical Division and Center for Nonlinear Studies, Los Alamos National Laboratory, Los  
16        Alamos, New Mexico, United States of America

17        †Current address: Theoretical Division and Center for Nonlinear Studies, Los Alamos National  
18        Laboratory, Los Alamos, New Mexico, United States of America

19        #Current address: Department of Chemistry and Chemical Biology, Cornell University, Ithaca,  
20        New York, United States of America

21        \*Corresponding author. Email: [richard.posner@nau.edu](mailto:richard.posner@nau.edu)

24 **Abstract:** During an early period of the Coronavirus Disease 2019 (COVID-19) pandemic, the  
25 Navajo Nation, much like New York City, experienced a relatively high rate of disease  
26 transmission. Yet, between January and October 2020, it experienced only a single period of  
27 growth in new COVID-19 cases, which ended when cases peaked in May 2020. The daily  
28 number of new cases slowly decayed in the summer of 2020 until late September 2020. In  
29 contrast, the surrounding states of Arizona, Colorado, New Mexico, and Utah all experienced at  
30 least two periods of growth in the same time frame, with second surges beginning in late May to  
31 early June. To investigate the causes of this difference, we used a compartmental model  
32 accounting for distinct periods of non-pharmaceutical interventions (NPIs) (e.g., behaviors that  
33 limit disease transmission) to analyze the epidemic in each of the five regions. We used Bayesian  
34 inference to estimate region-specific model parameters from regional surveillance data (daily  
35 reports of new COVID-19 cases) and to quantify uncertainty in parameter estimates and model  
36 predictions. Our results suggest that NPIs in the Navajo Nation were sustained over the period of  
37 interest, whereas in the surrounding states, NPIs were relaxed, which allowed for subsequent  
38 surges in cases. Our region-specific model parameterizations allow us to quantify the impacts of  
39 NPIs on disease incidence in the regions of interest.

40

41 **Keywords:** Severe Acute Respiratory Syndrome Coronavirus 2 (SARS-CoV-2), Ordinary  
42 Differential Equations (ODEs), Mathematical Model, Statistical Inference, Markov Chain Monte  
43 Carlo (MCMC).

44

45

46

## 47 **Introduction**

48 An outbreak of pneumonia of unknown cause starting in Wuhan, China was recognized  
49 in late December 2019 and widely reported in early January 2020 [1, 2]. The disease was later  
50 named Coronavirus Disease 2019 (COVID-19) [1]. The causative agent was identified as a novel  
51 coronavirus, later named Severe Acute Respiratory Syndrome Coronavirus 2 (SARS-CoV-2).  
52 COVID-19 rapidly spread to other countries [1, 2, 3], and the World Health Organization  
53 (WHO) declared the COVID-19 outbreak a pandemic on March 11, 2020 [4]. In the United  
54 States (US), during the early months of the pandemic, two regions were severely affected as  
55 measured by cumulative number of COVID-19 cases per capita: *Diné Bikéyah*, more commonly  
56 known as the Navajo Nation, and New York City.

57 On May 18, 2020, the Navajo Nation had the highest cumulative number of COVID-19  
58 cases per hundred thousand in the US (2,344 cases per 100,000 residents), surpassing the New  
59 York City metropolitan statistical area (MSA), which had 1,806 cases per 100,000 residents  
60 [5,6]. Remarkably, both regions significantly slowed the transmission of COVID-19 and  
61 prevented additional surges in new COVID-19 cases until late September 2020 while many other  
62 regions, including the states of Arizona, Colorado, New Mexico, and Utah, each experienced a  
63 series of two surges in cases during the same period [6].

64 The President of the Navajo Nation and the Governors of the surrounding states of  
65 Arizona, Colorado, New Mexico, and Utah independently issued guidance and mandates to  
66 control the spread of COVID-19. These non-pharmaceutical interventions (NPIs) enforced or  
67 encouraged an array of behaviors that putatively protect susceptible individuals from SARS-  
68 CoV-2 infection, such as curtailing of travel, reduction in face-to-face interaction, face mask-  
69 wearing, working from home, etc. Although the governmental actions across the five regions

70 were similar, there were notable differences, particularly in the duration of mandates, as we will  
71 discuss later. The disease transmission dynamics in the five regions were also different. In the  
72 Navajo Nation, the number of new cases detected daily rose sharply in late March to early April,  
73 peaked in May, and then steadily declined until late September 2020 [7]. In contrast, in each of  
74 the surrounding states, there were at least two periods of growth in new cases between 01-  
75 March-2020 and 14-September-2020 [6].

76       Insights into why the Navajo Nation experienced only a single period of growth in new  
77 COVID-19 cases during the period of interest while neighboring regions experienced two  
78 distinct phases of increasing case counts could point to strategies for controlling transmission of  
79 diseases similar to COVID-19 in the future. A possible explanation for the difference between  
80 the Navajo Nation (with one phase of growth in disease incidence) and the surrounding states  
81 (each with two phases of growth in disease incidence) is that NPIs were more effective and/or  
82 more sustained in the Navajo Nation. To evaluate this hypothesis, for each of the five regions of  
83 interest, we sought to use region-specific daily case reporting data to infer parameters of a  
84 compartmental model for COVID-19 transmission that accounts for subpopulations of  
85 susceptible individuals protected or not from SARS-CoV-2 infection by NPIs. The model  
86 structure allows for multiple phases, or periods, of NPIs. Each phase is associated with three  
87 parameters: an onset time, a sum of rate constants that defines a timescale for transition to a  
88 setpoint level of adoption of disease-avoiding behaviors, and the setpoint (the fraction of the  
89 regional population adopting disease-avoiding behaviors). We have previously shown that this  
90 model is able to reproduce the dynamics of regional COVID-19 epidemics in 2020 in 280 of 384  
91 MSAs in the US [8], including the 15 most populous metropolitan areas [7], and in all 50 states  
92 [9].

93 We adopted a Bayesian inference approach enabled by Markov chain Monte Carlo  
94 (MCMC) sampling to obtain samples of region-specific parameter posteriors. Inferences were  
95 conditioned on one to three periods of NPIs, uniform proper priors, a negative binomial model  
96 for surveillance noise, estimates of selected parameters taken to have the same values across all  
97 regions of interest [7], and were based on daily counts of new cases available from January 21 to  
98 September 14, 2020. Following Lin et al. [7], we used model selection to determine the most  
99 parsimonious number of NPI periods. A model structure and parameterization were thus found  
100 for each region of interest. Each parameterization allows the model with selected structure to  
101 explain the corresponding regional epidemic curve. The parameter posteriors found indicate that  
102 NPIs were not more effective but were more sustained in the Navajo Nation than in the  
103 surrounding states.

## 104 **Methods**

105 The COVID-19 surveillance data used to parameterize the model for the Navajo Nation  
106 was obtained from the *Navajo Times* COVID-19 webpage [5]. The *Navajo Times* provided daily  
107 reports of new confirmed COVID-19 cases over the period of interest. The reported source of  
108 this information was the Navajo Nation Department of Health (NNDOH) [10]. The COVID-19  
109 surveillance data used to parameterize the models for Arizona, Colorado, New Mexico, and Utah  
110 were obtained from a GitHub repository maintained by *The New York Times* newspaper [11].  
111 This GitHub repository collects new case reports from local health agencies in the United States.  
112 For each of the four states, we aggregated county-level case counts to obtain state-level case  
113 counts.

114 Information and data used to compare NPI mandates in each of the four states  
115 neighboring the Navajo Nation were obtained from the *John Hopkins Coronavirus Resource*

116 *Center* [12]. This NPI resource webpage collects state-wide NPI mandates issued by each US  
117 state's governor and plots when they were issued against daily new cases to visualize the effect  
118 of NPIs on trends in new COVID-19 cases. The *John Hopkins Coronavirus Resource Center*  
119 collects policy data from various state-specific websites such as state and governor websites and  
120 from the National Governors Association. It should be noted that information in this resource  
121 characterizes state-level mandates only; information about county-level mandates is less readily  
122 available and was not considered in this study. Information about NPI mandates in the Navajo  
123 Nation was obtained from the NNDOH public website [10]. Using policy data collected by *John*  
124 *Hopkins Coronavirus Resource Center* and reported by the NNDOH, we compared  
125 governmental mandates in the Navajo Nation and the four surrounding states.

126         The model we considered in this study is that of Lin et al. [7]. It is a compartmental  
127 model that divides a regional population of interest into susceptible (S), exposed (E), infectious  
128 (I), and removed (R) compartments (Fig 1). Exposed persons transition through a series of five  
129 stages, introduced to capture the distribution of incubation times observed for COVID-19 [13].  
130 The model also accounts for quarantine, self-isolation because of symptom awareness,  
131 hospitalization, and death. Importantly, persons are allowed to transition between two modes of  
132 behavior, in which they are either protected (imperfectly) from infection (because of adoption of  
133 disease-avoiding behaviors) or are mixing freely (i.e., taking no special precautions to prevent  
134 infection). The model tracks 25 compartments and each compartment corresponds to an ordinary  
135 differential equation (ODE). There is an auxiliary 1-parameter measurement model, which  
136 relates the variables of the compartmental model to reported new cases through surveillance  
137 testing [7]. The equations of the mechanistic compartmental model and the measurement model  
138 can be found in Appendix 1 of Lin et al. [7].

139           The model accounts for an initial phase of NPIs beginning at time  $t = \sigma$ , where  $\sigma$  is fixed  
140 to the date the region of interest accumulated at least 200 COVID-19 cases. The model can be  
141 extended to account for  $n$  additional periods. Thus, the total number of NPI periods considered in  
142 a regional model is given by  $n + 1$  [7]. The start of a new NPI phase is accompanied by step  
143 changes in the values of the three NPI parameters. In the models for the Navajo Nation (NN),  
144 Arizona (AZ), Colorado (CO), New Mexico (NM), and Utah (UT), we considered three possible  
145 settings for  $n$  (the number of additional NPI periods beyond the initial period):  $n = 0$  (only one  
146 NPI period over the entire period of interest),  $n = 1$  (two NPI periods), and  $n = 2$  (three NPI  
147 periods). The setting for  $n$  was determined as described below.

148           To determine the structure of the compartmental model for each region of interest (i.e.,  
149 the number of distinct NPI phases), we used a heuristic model-selection method. In this  
150 approach, we calculated the value of the Akaike information criterion corrected for small sample  
151 size ( $AICc$ ) for  $n$  and  $n + 1$  versions of the model, where  $n = 0, 1$ . We also calculated the value  
152 of the Bayesian information criterion ( $BIC$ ) for the same two versions of each model.  $\Delta AICc$  is  
153 defined as the change in  $AICc$  between  $n$  and  $n + 1$  versions of the models:  $\Delta AICc = AICc^n -$   
154  $AICc^{n+1}$ .  $\Delta BIC$  is defined similarly:  $\Delta BIC = BIC^n - BIC^{n+1}$ . We adopted  $n + 1$  over  $n$  when  
155 both of the following conditions held true:  $\Delta AICc > 10$  and  $\Delta BIC > 10$ . The method of model  
156 selection described above was used to decide between the use of  $n = 0$  and  $n = 1$ , and between  
157 the use of  $n = 1$  and  $n = 2$  [7, 14].

158           In the case of only an initial NPI period ( $n = 0$ ), the compartmental model and auxiliary  
159 measurement model have 20 parameters combined. Five of the parameters are considered  
160 adjustable; these parameters are all region-dependent. The other 15 parameters are taken to have

161 fixed values. The 15 fixed parameters are  $S_0$ ,  $\sigma$ ,  $I_0$ ,  $m_b$ ,  $\rho_E$ ,  $\rho_A$ ,  $k_L$ ,  $k_Q$ ,  $j_Q$ ,  $f_A$ ,  $f_H$ ,  $f_R$ ,  $c_A$ ,  $c_I$ , and  
162  $c_H$ . The parameter  $S_0$  represents the total population of the region of interest, as determined by  
163 census data [15], which we took to be fixed.  $I_0$  refers to the starting number of infected  
164 individuals. We used  $I_0 = 1$ .  $\rho_E$  and  $\rho_A$  refer to the relative infectiousness of exposed persons  
165 and asymptomatic persons, respectively, compared to symptomatic persons [16, 17]. Infected  
166 persons are taken to enter quarantine with rate constant  $k_Q$  and persons with symptoms and mild  
167 disease are taken to self-isolate with rate constant  $j_Q$ . Persons in the protected subpopulation (i.e.,  
168 persons adopting disease-avoiding behaviors) are taken to be less likely to acquire or transmit  
169 disease by a factor  $m_b$ . In the model, the incubation period is divided into 5 stages. Movement  
170 from one stage to the next occurs with rate constant  $k_L$  [13]. The fraction of exposed persons  
171 who never become symptomatic is represented by  $f_A$ . The fraction of symptomatic persons who  
172 progress to severe disease (and hospitalization or isolation at home) is represented by  $f_H$  [18].  
173 The fraction of persons with severe disease who recover is represented by  $f_R$ . Persons with  
174 asymptomatic disease leave the immune clearance stage of infection and recover with rate  
175 constant  $c_A$  [19]. Persons with mild symptomatic disease recover with rate constant  $c_I$  [20].  
176 Persons with severe disease recover with rate constant  $c_H$  [21]. The five adjustable parameters  
177 are  $t_0$ ,  $p_0$ ,  $\lambda_0$ ,  $\beta$ , and  $f_D$ . The parameter  $t_0$  refers to the start time of local sustained COVID-19  
178 transmission;  $p_0$  is the initial non-zero value of  $P_\tau(t)$ , the stationary fraction of the local  
179 population that is practicing disease-avoiding behaviors;  $\lambda_0$  is the initial non-zero value of  $\Lambda_\tau(t)$ ,  
180 a sum of rate constants that establishes a time scale for the establishment of the quasi-stationary  
181 state of NPIs;  $\beta$  is the disease transmission rate constant (or contact rate parameter) in the  
182 absence of NPIs; and  $f_D$  is the fraction of new infections detected in surveillance. The parameter  
183  $f_D$  characterizes the effectiveness of surveillance and relates new cases to new infections. In the



184 model,  $P_\tau(t)$  and  $\Lambda_\tau(t)$  are taken to be step functions. Each of these functions has a value of 0  
185 until  $t = \sigma$  and thereafter changes value at a set of  $n$  times (if  $n > 0$ ), denoted  $\tau = \{\tau_1 >$   
186  $\sigma, \dots, \tau_n > \tau_{n-1}\}$ . The value of  $n$  starts at 0 and is incremented through model selection as  
187 described above. There is one additional adjustable parameter,  $r$ , the dispersion parameter of a  
188 negative binomial distribution  $NB(p, r)$  used to characterize noise in case detection [7]. The  
189 value of  $r$  is inferred jointly with the five adjustable model parameters.

190 In the case of one additional NPI period beyond the initial period ( $n = 1$ ), three more  
191 adjustable parameters are used, which are denoted  $\tau_1$ ,  $p_1$ , and  $\lambda_1$ . The latter two parameters  
192 determine the new values of  $P_\tau(t)$ , and  $\Lambda_\tau(t)$  at time  $t = \tau_1$ , the start time of the second phase of  
193 NPIs. In general, three more adjustable parameters are added to the model each time  $n$  is  
194 incremented. The equations of the compartmental model and of the auxiliary model can be found  
195 in Appendix 1 of Lin et al. [7].

196 Bayesian inference of adjustable region-specific model parameter values was based on  
197 new daily case count data for NN, AZ, CO, NM, or UT. MCMC sampling was performed to  
198 obtain samples of the parameter posterior. We used an adaptive MCMC sampling algorithm  
199 described earlier [22] and implemented in the PyBioNetFit software package [23]. PyBioNetFit  
200 job setup files for the inferences performed in this study, including data files, are available online  
201 (<https://github.com/lanl/PyBNF/tree/master/examples/Miller2022NavajoNation>). We quantified  
202 uncertainty in daily case reports through resampling of the parameter posteriors so as to generate  
203 a posterior predictive distribution for daily number of new cases detected [7].

## 204 **Results**

205           The objective of our study was to quantify the effect of early non-pharmaceutical  
206 interventions (NPIs) on the transmission of COVID-19 in the Navajo Nation (NN) and  
207 surrounding states: Arizona (AZ), Colorado (CO), New Mexico (NM), and Utah (UT). We  
208 achieved this by applying Bayesian inference enabled by Markov chain Monte Carlo (MCMC)  
209 sampling to obtain posterior samples for NPI parameters of a mechanistic region-specific  
210 compartmental mathematical model for each region of interest (Figure 1). Inference was based  
211 on COVID-19 daily confirmed case count data. Because we set out to quantify the effectiveness  
212 of early NPIs during the emergence of SARS-CoV-2 in the US, we used case data available for  
213 the period starting on 21-January-2020 and ending on 14-September-2020.

214           The model we used to analyze data from the NN and surrounding states is illustrated in  
215 Figure 1. The model accounts for movement between different states of protection against  
216 SARS-CoV-2 infection because of disease-avoiding behaviors. In the model, persons are allowed  
217 to be in three states of protection: a state in which an uninfected person is protected imperfectly  
218 against infection because of disease-avoiding behaviors, a state in which an uninfected person is  
219 more exposed to infection because they do not take any special precautions to avoid infection,  
220 and a state in which an infected person is quarantined or in self-isolation. In the model, an initial  
221 NPI period ( $n = 0$ ) begins as soon as the number of cumulative cases reaches or exceeds 200. A  
222 new NPI period is introduced through the model-selection procedure described in Methods.  
223 When a new NPI period is introduced,  $n$  is incremented and NPI parameters change.

224           Figure 2 and Figure 3 show 95% credible intervals of posterior predictive distributions  
225 for daily case detection for the NN and the four surrounding states. Posterior predictive  
226 distributions were found by drawing from parameter posterior samples generated through  
227 MCMC sampling, thereby propagating parametric uncertainty into prediction uncertainty. In the

228 posterior predictive distributions, NN only has surge in disease incidence whereas the  
229 surrounding states each have at least two surges.

230 Figure 2 and Figure 3 show curves for the daily number of new symptomatic infections  
231 (vs. cases) based on maximum a posteriori (MAP) estimates for parameters (which are  
232 equivalent to maximum likelihood estimates because of the use of uniform proper priors). In our  
233 calculations, the number of detected cases over a 1-d period is taken to be a fraction  $f_D$  of the  
234 number of new symptomatic infections generated during that same period. The value of  $f_D$  is  
235 region-specific. The MAP estimate for  $f_D$  is 0.2 for the Navajo Nation, 0.15 for Arizona, 0.35 for  
236 Colorado, 0.04 for New Mexico, and 0.07 for Utah.

237 Figure 2 and Figure 3 indicate when distinct NPI periods were determined to have  
238 begun. Table 1 summarizes results of the model-selection procedure used to decide between 1 or  
239 2 or more NPI phases for each region of interest. The Navajo Nation was the only region of  
240 interest to have  $\Delta AICc$  and  $\Delta BIC$  values indicating only one NPI phase.

241 Figure 4 shows the marginal posteriors of the setpoint parameters  $\{p_0, \dots, p_n\}$  for each  
242 region, which were generated by MCMC sampling. Recall that each of these parameters  
243 determines the quasi-stationary population fraction adopting disease-avoiding behaviors and that  
244 there is a distinct setpoint for each distinct NPI phase (e.g.,  $p_0$ ,  $p_1$ , and  $p_2$  for a region with three  
245 distinct NPI phases). For the Navajo Nation, we inferred only a single NPI phase over the period  
246 of interest. This phase is characterized by a NN-specific value for the setpoint parameter  $p_0$ . The  
247 marginal posterior for  $p_0$  for the NN is shown in Figure 4A. In surrounding states, we inferred  
248 changes in adherence to disease-avoiding behaviors, i.e., different setpoints over time. The  
249 marginal posteriors for the state-specific setpoint parameters are shown in Figures 4B–4E.

250 Comparison of the marginal posteriors for different NPI phases within a given state  
251 reveals a significant relaxation in disease-avoiding behaviors in each state. Figure 5 shows MAP  
252 estimates for NPI setpoint parameters (e.g.,  $p_0$ ) for each region of interest over time. A higher  
253 setpoint indicates a higher prevalence of disease-avoiding behaviors. For the period of interest,  
254 we found that all regions experienced a decrease in their setpoint parameter values after an initial  
255 NPI phase except the Navajo Nation. Although Arizona, Colorado, and Utah initially had a  
256 higher setpoint than the Navajo Nation, the Navajo Nation maintained the initial setpoint for a  
257 longer period in comparison to the surrounding states.

258 Figure 6 shows Navajo Nation COVID-19 case data from 21-January-2020 to 5-  
259 February-2021 and projections of daily case counts for selected NPI scenarios after 14-  
260 September-2020. Between 21-January-2020 and 14-September-2020, the Navajo Nation  
261 maintained disease-avoiding behaviors (as characterized by the setpoint parameter  $p_0$ ) and  
262 experienced only one surge in COVID-19 cases. However, after this period, the Navajo Nation  
263 experienced an additional surge in COVID-19 cases. The solid red curve in Figure 6 is the  
264 trajectory corresponding to the MAP estimate of  $p_1$ , obtained using data collected after 14-  
265 September-2020, and the dotted curves are different hypothetical trajectories based on lower and  
266 higher values for the NPI parameter  $p_1$ . We found that the Navajo Nation would have needed to  
267 maintain a value for  $p_1$  greater than 0.27 after 14-September-2020 to avoid a surge in disease  
268 transmission.

269 Figure 7 presents a timeline of governmental mandates between 21-January-2020 and 14-  
270 September-2020 in the Navajo Nation and the four surrounding states. Four mandates are  
271 considered, which are related to face mask wearing, mass gatherings, non-essential business  
272 closures, and weekend lockdowns. As can be seen, these mandates were in effect for the longest

273 duration in the Navajo Nation. Mandates in surrounding states were in effect for shorter  
274 durations and were imposed less consistently.

## 275 **Discussion**

276 In this study, we used a compartmental model to quantify the overall effect of non-  
277 pharmaceutical interventions (NPIs) on COVID-19 transmission in specific regions, namely the  
278 Navajo Nation and the four surrounding states. The model for a given region includes a set of  
279 NPI setpoint parameters, each of which represents the quasi-stationary fraction of the regional  
280 population that is practicing disease-avoiding behaviors for a given period. By using surveillance  
281 data (daily case counts) to infer the region-specific values of the NPI setpoint parameters, we  
282 quantified the relative overall effectiveness of NPIs across the regions of interest. We detected  
283 changes in disease-avoiding behaviors over time using a model selection procedure, which  
284 indicates when an NPI setpoint needs to change value for consistency with surveillance data. A  
285 limitation of our approach is that we cannot ascertain the relative effectiveness of individual  
286 NPIs. Another limitation is that our model can only explain surges in disease incidence by  
287 relaxation of NPIs. The model does not account for other factors that could cause surges, such as  
288 increased disease transmissibility associated with emergence of a viral variant or loss of  
289 immunity.

290 From 21-January-2020 to 14-September-2020, we found that the Navajo Nation  
291 maintained the initial NPI setpoint throughout this period (Figure 4 and Figure 5), consistent  
292 with a single surge in COVID-19 incidence (Figure 2). In contrast, we found that the surrounding  
293 states of Arizona, Colorado, New Mexico, and Utah did not. That is, each surrounding state had  
294 two or more NPI phases, marked by different NPI setpoints and multiple surges in COVID-19  
295 incidence. These findings are consistent with a comparison of governmental mandates across the

296 five regions of interest (Figure 7). Sustained NPIs is unique to the Navajo Nation and suggests  
297 an explanation for why this region experienced only one surge in COVID-19 cases while other  
298 regions experienced multiple surges.

299 Interestingly, we inferred that the fraction of the NN population adopting disease-  
300 avoiding behaviors upon initial implementation of NPIs was lower than that in Arizona,  
301 Colorado, and Utah and similar to that in New Mexico. These results implicate sustained NPIs  
302 (rather than effectiveness of NPIs) as the reason for the different disease transmission dynamics  
303 between the Navajo Nation (only a single surge in disease incidence) and the surrounding states  
304 (multiple surges).

305 Our results suggest that NPIs, even if only partially adopted, can slow and control disease  
306 transmission if mandates are consistent and are not relaxed prematurely or to too great an extent.  
307 We determined that the Navajo Nation's NPI setpoint parameter value between 21-January-2020  
308 and 14-September-2020 was 0.35 but the value changed to 0.19 after 14-September-2020, in  
309 concert with a second surge in disease incidence. We determined the minimum NPI setpoint  
310 parameter value needed to maintain control of disease transmission (i.e., to avoid a surge in  
311 disease incidence) to be 0.27 (Figure 6). In other words, the second surge could have been  
312 prevented if 27% of the population had maintained disease-avoiding behaviors after 14-  
313 September-2020.

314 We inferred two other notable differences between the regions of interest beyond  
315 differences in adoption of effective NPIs. First, surveillance efforts may have had different levels  
316 of effectiveness. Our MAP estimates for  $f_D$ , the fraction of new infections detected, ranged from  
317 a low of 0.04 for New Mexico to a high of 0.35 for Colorado. Colorado, New Mexico, and Utah  
318 had similar numbers of cases per 100,000 residents but the inferred differences in surveillance

319 effectiveness suggest that COVID-19 impacts were significantly greater in New Mexico and  
320 Utah than in Colorado. Second, there were differences in contagiousness across the regions of  
321 interest. Our MAP estimates for  $\beta$ , the contact rate parameter, ranged from just over 0.3 per day  
322 for the Navajo Nation and New Mexico to just over 0.5 per day for Arizona. Using the formula  
323 for the basic reproduction number  $R_0$  given by Mallela et al. [9], these differences in  $\beta$  estimates  
324 translate into the following estimated  $R_0$  values for the five regions: 3.6 for New Mexico, 3.7 for  
325 the Navajo Nation, 4.4 for Utah, 4.6 for Colorado, and 5.9 for Arizona. Thus, the relatively high  
326 adoption of effective NPIs in Arizona was offset by relatively high transmission of COVID-19.  
327 Our analysis does not provide insight into why contagiousness varied across the regions of  
328 interest.

329         In summary, our analysis suggests that once NPIs have brought an outbreak under  
330 control, relaxation of the NPIs can be implemented but relaxation should be gradual to avoid a  
331 new surge in disease incidence. A relatively low level of disease incidence is not an indicator  
332 that NPIs can be safely relaxed. Moreover, a model accounting for NPIs can perhaps be used to  
333 guide relaxation of NPIs in a controlled manner.

334

335 **Acknowledgments**

336 YC, WSH, EFM, JN, and RGP acknowledge support from the National Institute of General  
337 Medical Sciences of the National Institutes of Health (grant R01GM111510). AM acknowledges  
338 support from the 2020 National Science Foundation Mathematical Sciences Graduate Internship  
339 Program and the Center for Nonlinear Studies at Los Alamos National Laboratory. WSH and  
340 YTL acknowledge support from the Laboratory Directed Research and Development Program at  
341 Los Alamos National Laboratory (project 20220268ER). We acknowledge use of the Monsoon  
342 computer cluster at Northern Arizona University, which is funded by Arizona's Technology and  
343 Research Initiative Fund.  
344



345 **Author Contributions**

346 Conceptualization: EFM, WSH, RGP

347 Data Curation: EFM

348 Formal Analysis: EFM

349 Funding Acquisition: WSH, RGP, YC, AM, YTL

350 Investigation: EFM

351 Methodology: EFM, JN, AM, WSH, YTL

352 Project Administration: WSH, RGP

353 Resources: RGP

354 Software: EFM, JN, YTL

355 Supervision: RGP, WSH, YC

356 Validation: EFM, AM

357 Visualization: EFM

358 Writing – Original Draft Preparation: EFM, WSH, RGP

359 Writing – Review & Editing: EFM, JN, YC, AM, YTL, WSH, RGP

360

361 **References**

- 362 1. Gorbalenya AE, Baker SC, Baric RS, de Groot RJ, Drosten C, Gulyaeva AA, et al. The  
363 species severe acute respiratory syndrome-related coronavirus: classifying 2019-nCoV  
364 and naming it SARS-CoV-2. *Nat Microbiol.* 2020.
- 365 2. Holshue ML, DeBolt C, Lindquist S, Lofy KH, Wiesman J, Bruce H, et al. First case of  
366 2019 novel coronavirus in the United States. *New England Journal of Medicine.*  
367 2020;382(10):929–36.
- 368 3. The Covid Tracking Project [Internet]. Available from: <https://covidtracking.com/>
- 369 4. Cucinotta D, Vanelli M; CDV. Who declares COVID-19 a pandemic [Internet]. *Acta bio-*  
370 *medica: Atenei Parmensis.* U.S. National Library of Medicine. Available from:  
371 <https://pubmed.ncbi.nlm.nih.gov/32191675/>
- 372 5. COVID-19 Across the Navajo Nation [internet]. Available from:  
373 <https://navajotimes.com/coronavirus-updates/covid-19-across-the-navajo-nation/>
- 374 6. Coronavirus in the U.S.: Latest map and case count - The New York Times [Internet].  
375 Available from: <https://www.nytimes.com/interactive/2021/us/covid-cases.html>
- 376 7. Lin YT, Neumann J, Miller EF, Posner RG, Mallela A, Safta C, et al. Daily forecasting of  
377 regional epidemics of coronavirus disease with Bayesian uncertainty quantification,  
378 United States. *Emerging Infectious Diseases.* 2021;27(3):767–78.
- 379 8. Mallela A, Lin YT, Hlavacek WS. Differential contagiousness of respiratory disease  
380 across the United States [Internet]. medRxiv. Cold Spring Harbor Laboratory Press;  
381 2022. Available from: <https://www.medrxiv.org/content/10.1101/2022.09.15.22279948v1>

382

- 383 9. Mallela A, Neumann J, Miller EF, Chen Y, Posner RG, Lin YT, et al. Bayesian inference  
384 of state-level COVID-19 basic reproduction numbers across the United States. *Viruses*.  
385 2022;14(1):157.
- 386 10. Dikos Ntsaaígíí-19 (COVID-19) [Internet]. Navajo Nation Department of Health.  
387 Available from: <https://www.ndoh.navajo-nsn.gov/COVID-19>
- 388 11. New York Times. COVID-19-data: An ongoing repository of data on coronavirus cases  
389 and deaths in the U.S. [Internet]. GitHub. Available from:  
390 <https://github.com/nytimes/covid-19-data>
- 391 12. Impact of opening and closing decisions in the U.S.- Johns Hopkins [Internet]. Johns  
392 Hopkins Coronavirus Resource Center. Available from:  
393 <https://coronavirus.jhu.edu/data/state-timeline>
- 394 13. Lauer SA, Grantz KH, Bi Q, Jones FK, Zheng Q, Meredith HR, et al. The incubation  
395 period of Coronavirus Disease 2019 (COVID-19) from publicly reported confirmed  
396 cases: Estimation and application. *Annals of Internal Medicine*. 2020;172(9):577–82.
- 397 14. Burnham KP, Anderson DR. Multimodel inference. *Sociological Methods & Research*.  
398 2004;33(2):261–304.
- 399 15. U.S. Census Bureau, 2020. Available from: <https://www.census.gov/en.html>
- 400 16. Van Vinh Chau N, Lam VT, Dung NT, Yen LM, Minh NNQ, Hung LM, et al. The  
401 natural history and transmission potential of asymptomatic severe acute respiratory  
402 syndrome coronavirus 2 infection. *Clinical infectious diseases: an official publication of*  
403 *the Infectious Diseases Society of America*. U.S. National Library of Medicine; 2020.  
404 Available from: <https://www.ncbi.nlm.nih.gov/pmc/articles/PMC7314145/>

- 405 17. Arons MM, Hatfield KM, Reddy SC, Kimball A, James A, Jacobs JR, et al.  
406 Presymptomatic SARS-COV-2 infections, and transmission in a skilled nursing facility.  
407 New England Journal of Medicine. 2020;382(22):2081–90.
- 408 18. Richardson S, Hirsch JS, Narasimhan M, Crawford JM, McGinn T, Davidson KW, et al.  
409 Presenting characteristics, comorbidities, and outcomes among 5700 patients hospitalized  
410 with covid-19 in the New York City area. JAMA. 2020;323(20):2052.
- 411 19. Sakurai A, Sasaki T, Kato S, Hayashi M, Tsuzuki S-ichiro, Ishihara T, et al. Natural  
412 history of asymptomatic SARS-COV-2 infection. New England Journal of Medicine.  
413 2020;383(9):885–6.
- 414 20. Perez-Saez J, Lauer SA, Kaiser L, Regard S, Delaporte E, Guessous I, et al. Serology-  
415 informed estimates of SARS-COV-2 infection fatality risk in Geneva, Switzerland. The  
416 Lancet Infectious Diseases. 2021;21(4).
- 417 21. Wölfel R, Corman VM, Guggemos W, Seilmaier M, Zange S, Müller MA, et al.  
418 Virological assessment of hospitalized patients with Covid-2019. Nature.  
419 2020;581(7809):465–9.
- 420 22. Andrieu C, Thoms J. A tutorial on adaptive MCMC. Statistics and Computing.  
421 2008;18(4):343–73.
- 422 23. Neumann J, Lin YT, Mallela A, Miller EF, Colvin J, Duprat AT, et al. Implementation of  
423 a practical Markov chain Monte Carlo sampling algorithm in PyBioNetFit.  
424 Bioinformatics. 2022;38(6):1770–2.

425

426

427

428 **Tables**

429

Region	$\Delta AICc$	$\Delta BIC$
<b>Navajo Nation</b>	-6.4	-15.7
<b>Arizona</b>	76.2	66.7
<b>Colorado</b>	108.3	99.1
<b>New Mexico</b>	56.6	47.4
<b>Utah</b>	98.1	89.0

430 Table 1: Results from our model-selection procedure used to select the number of NPI periods in  
431 each region. We calculated the value of the Akaike information criterion corrected for small  
432 sample size ( $AICc$ ) for  $n = 0$  and  $n = 1$  versions of the model, as well as and value of the  
433 Bayesian information criterion ( $BIC$ ) for the same two versions of each model. We defined  
434  $\Delta AICc = AICc^{n=0} - AICc^{n=1}$  and  $\Delta BIC = BIC^{n=0} - BIC^{n=1}$ . We adopted  $n = 1$  over  $n = 0$   
435 when  $\Delta AICc > 10$  and  $\Delta BIC > 10$  (i.e., we reject the hypothesis that  $n = 0$  when both  $\Delta AICc$   
436 and  $\Delta BIC$  are greater than 10). Accordingly,  $n = 0$  is indicated only for the Navajo Nation and  
437  $n > 0$  is indicated for all four surrounding states.

438

439

440

441

442

443

444

445

446 **Figures**

447

448

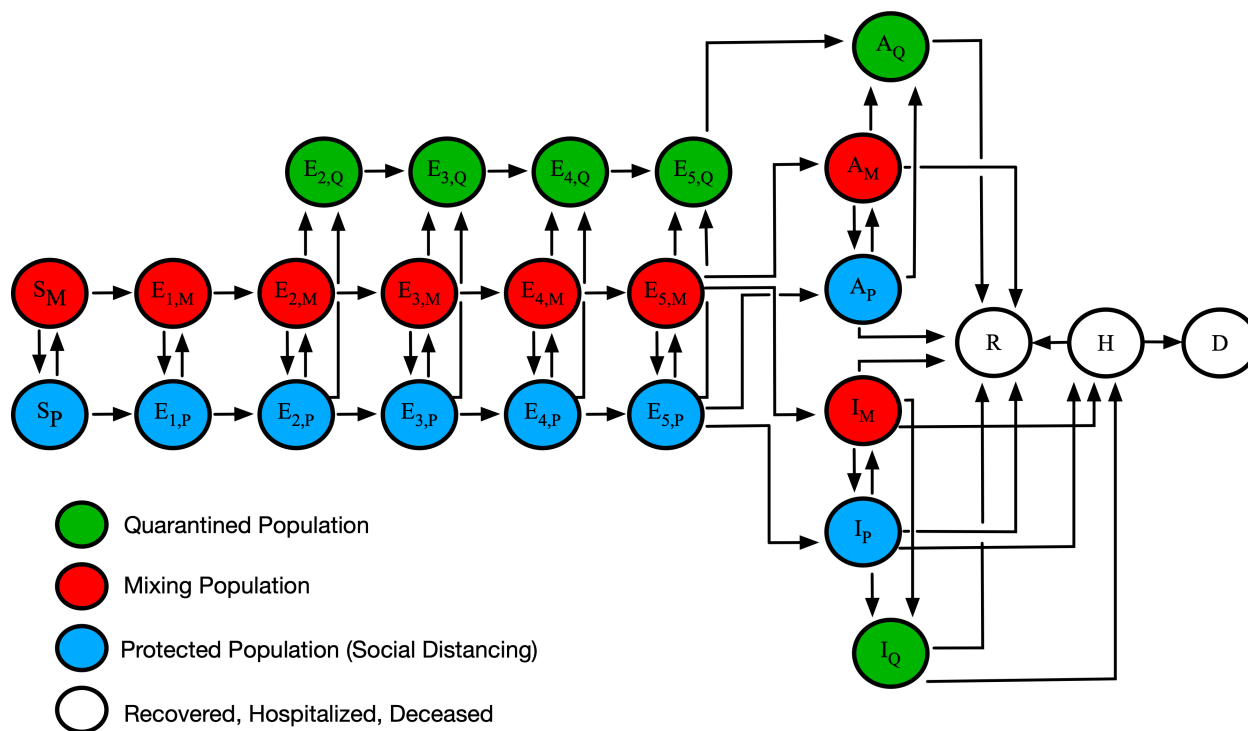
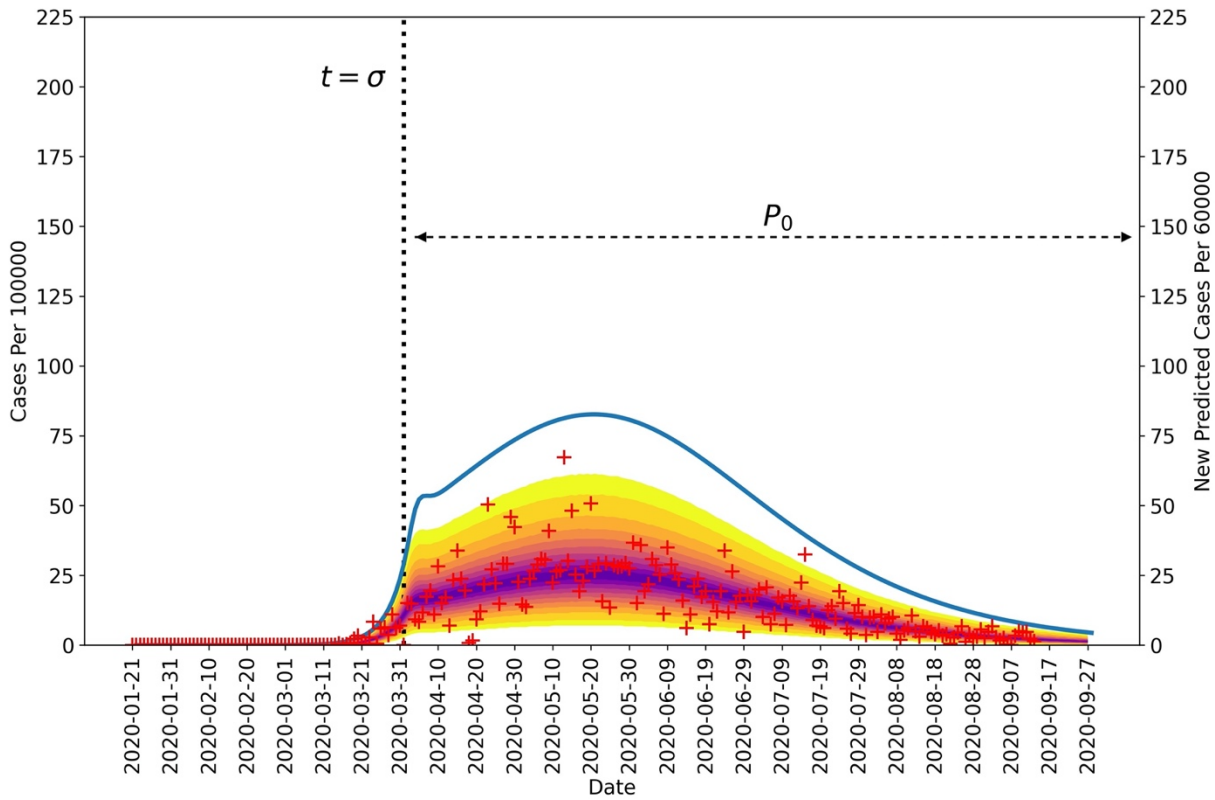

Figure 1: An illustration of the mechanistic compartmental model used to analyze COVID-19 data (7). The model captures various subpopulations, as indicated in the legend. Transitions between subpopulations marked by M, P and Q subscripts represent adoption and relaxation of disease-avoiding behaviors. The model accounts for susceptible persons (S), exposed persons not experiencing symptoms while incubating virus (E), asymptomatic persons in the immune clearance phase of infection who never develop symptoms (A), infected persons with mild symptoms (I), infected persons with severe illness (H), deceased persons (D), and recovered persons (R). The incubation period is divided into five stages. Red (subscript M) indicates persons in the mixing population, blue (subscript P) indicates persons in the protected population, green (subscript Q) indicates persons in the quarantined or self-isolated population, and white indicates persons who are recovered, hospitalized, or deceased.

462



463

464

465 Figure 2: Posterior predictive distribution for new cases detected in the Navajo Nation between  
466 21-January-2020 and 14-September-2020. The daily number of new COVID-19 cases detected in  
467 the Navajo Nation are indicated by red markers. The median percentiles of posterior samples are  
468 shown in purple. The blue curve indicates daily number of new infections and is based on MAP  
469 estimates for model parameters. The vertical black dotted line represents the time at which NPIs  
470 began in the Navajo Nation. The horizontal black dotted line indicates the duration of the initial  
471 NPI phase. It should be noted that the left and right vertical scales are different.

472

473



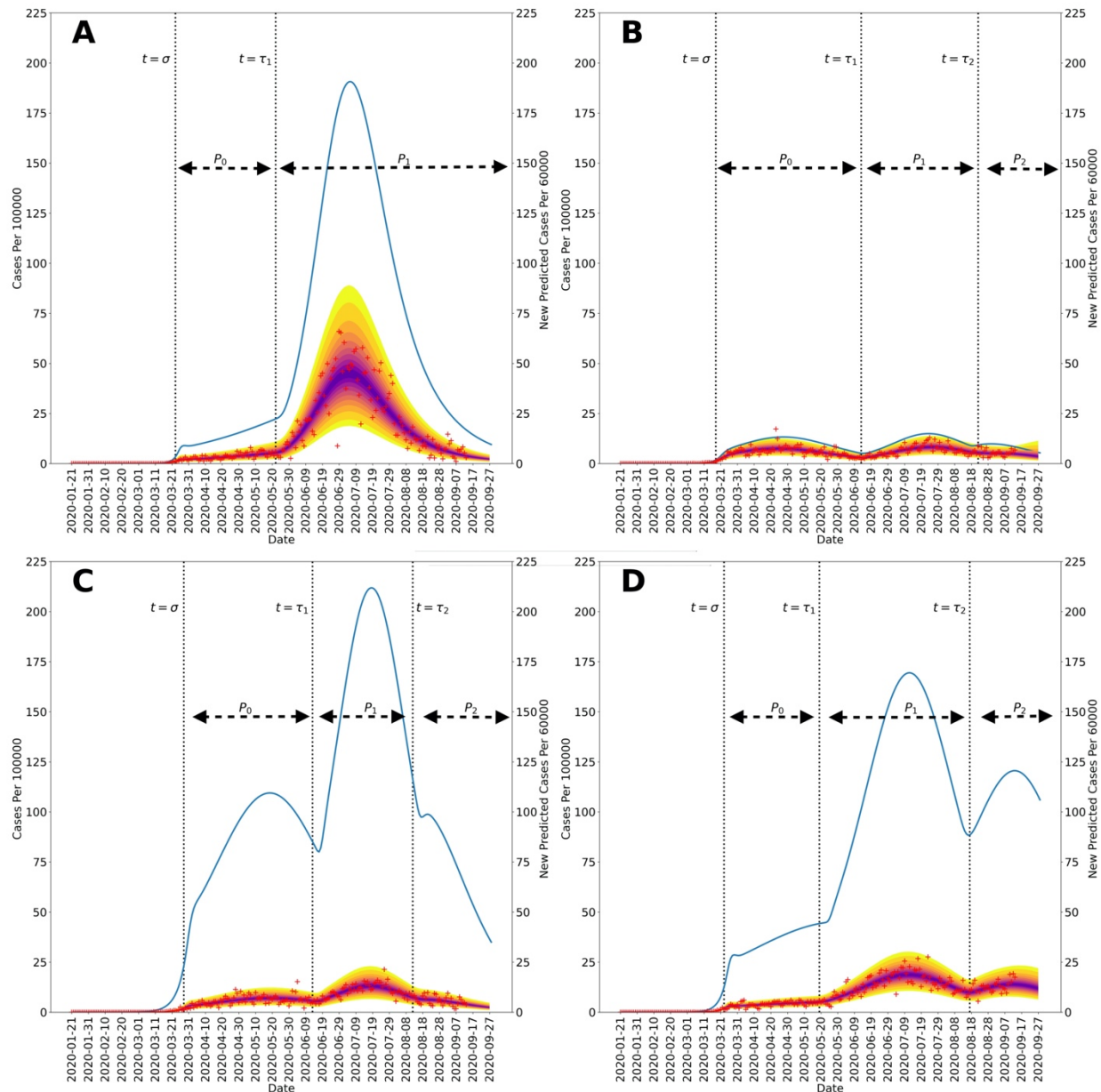

474

475

476 Figure 3: Posterior predictive distributions for new cases in the four US states surrounding the  
477 Navajo Nation between 21-January-2020, and 14-September-2020: (A) Arizona, (B) Colorado,  
478 (C) New Mexico, and (D) Utah. Recorded region-specific daily new cases of COVID-19 are  
479 indicated by red markers in each panel. The median parameter posterior estimates are shown in  
480 purple. The yellow bands delimited the 2.5 and 97.5 percentiles; the entire shaded region

481 indicates the 95% credible interval. In each panel, the blue curve indicates daily number of new  
482 infections and is based on MAP estimates for region-specific model parameters. The start times  
483 of NPI phases are indicated by vertical dotted lines. The initial NPI phase begins when  $t = \sigma$ ,  
484 the second NPI phase begins when  $t = \tau_1$ , and the third NPI phase begins when  $t = \tau_2$ . The  
485 horizontal black dotted lines indicate durations of NPI phases. It should be noted that the size of  
486 the first surge in Arizona, occurring in March and April 2020, is dwarfed by the size of the  
487 second surge. It should be noted that the left and right vertical scales of each panel are different.  
488

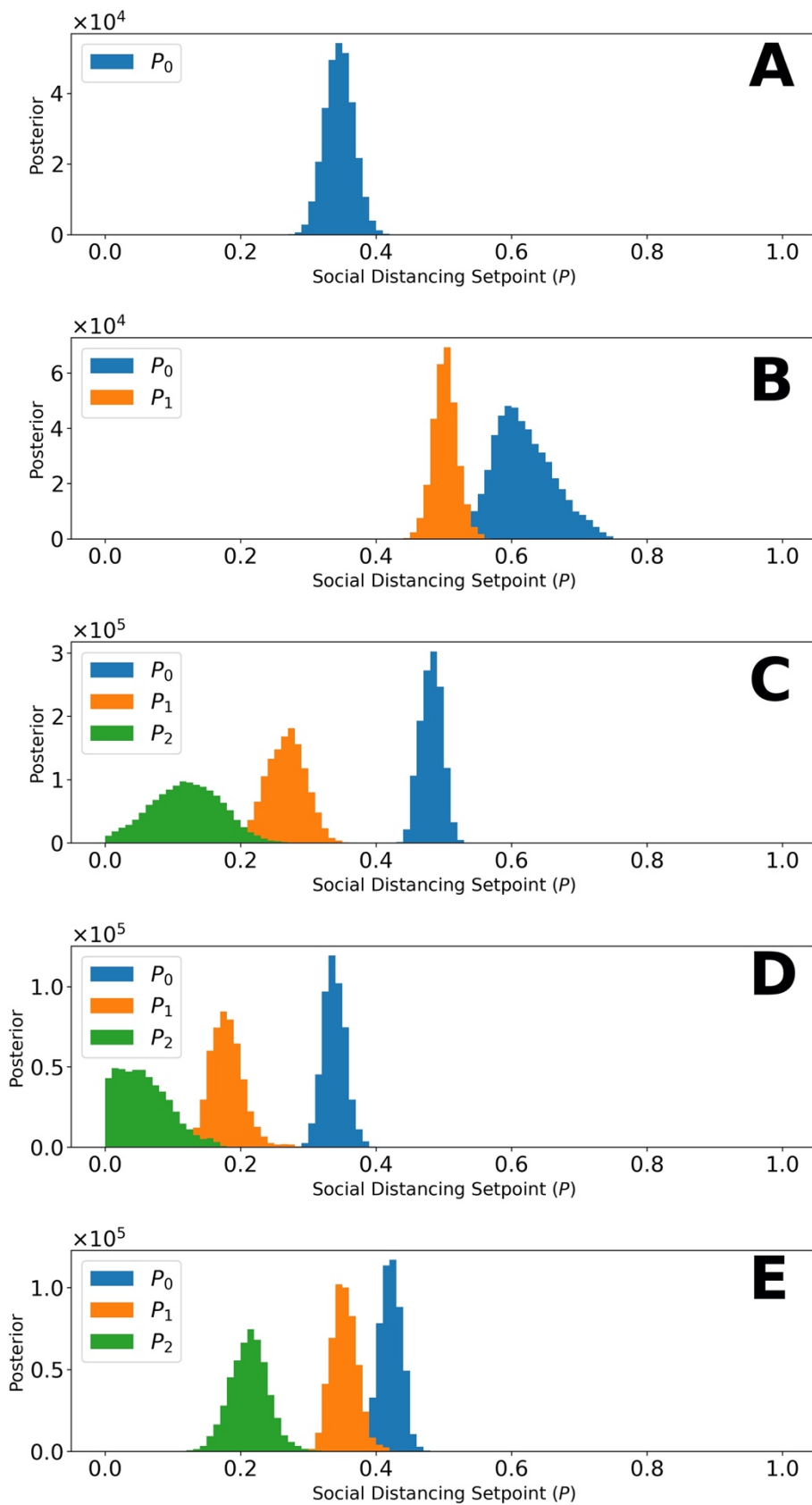

490

491 Figure 4: Marginal posteriors for parameters of the setpoint function  $P_\tau(t)$  (e.g.,  $p_0$ ) for (A)  
492 Navajo Nation, (B) Arizona, (C) Colorado, (D) New Mexico, and (E) Utah for the time period  
493 January 21, 2020, to September 14, 2020. Recall that  $P_\tau(t)$  denotes the fraction of the population  
494 practicing disease-avoiding behaviors at time  $t$ . The value of  $P_\tau(t)$ , a step function, is determined  
495 by one or more setpoint parameters, denoted  $p_0, p_1$ , etc. The Navajo Nation setpoint function  
496 parameter has the following maximum a posteriori (MAP) value:  $p_0 = 0.35$ . The Arizona setpoint  
497 function parameters have the following MAP values:  $p_0 = 0.60$  and  $p_1 = 0.5$ . The Colorado  
498 setpoint function parameters have the following MAP values:  $p_0 = 0.47$ ,  $p_1 = 0.27$ , and  $p_2 = 0.11$ .  
499 The New Mexico setpoint function parameters have the following MAP values:  $p_0 = 0.34$ ,  $p_1 =$   
500  $0.19$ , and  $p_2 = 0.05$ . The Utah setpoint function parameters have the following MAP values:  $p_0 =$   
501  $0.43$ ,  $p_1 = 0.35$ , and  $p_2 = 0.21$  For each region of interest, the NPI switch times,  $\tau = \{\tau_1, \dots, \tau_n\}$ ,  
502 are indicated in Figure 3.

503

504

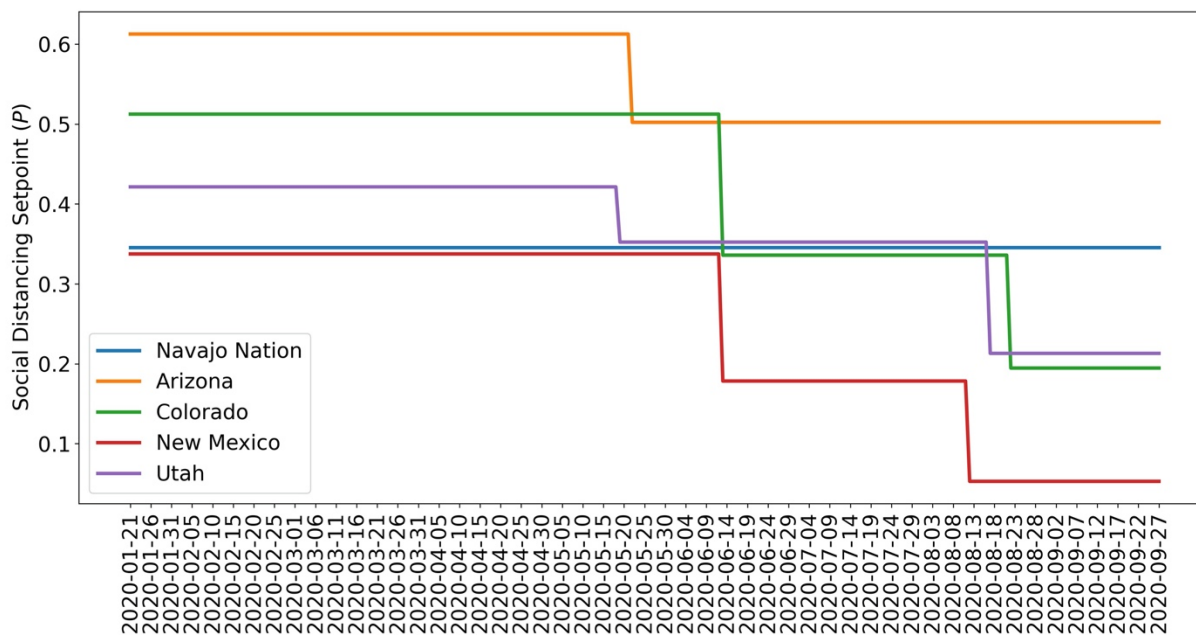

505

506

507 Figure 5: Value of the NPI setpoint function  $P_t(t)$  over time based on MAP estimates for NPI

508 setpoint parameters  $\{p_0, \dots, p_n\}$  for (A) Navajo Nation (B) Arizona, (C) Colorado, (D) New

509 Mexico, and (E) Utah. The period considered is 21-January-2020 to 14-September-2020.

510

511

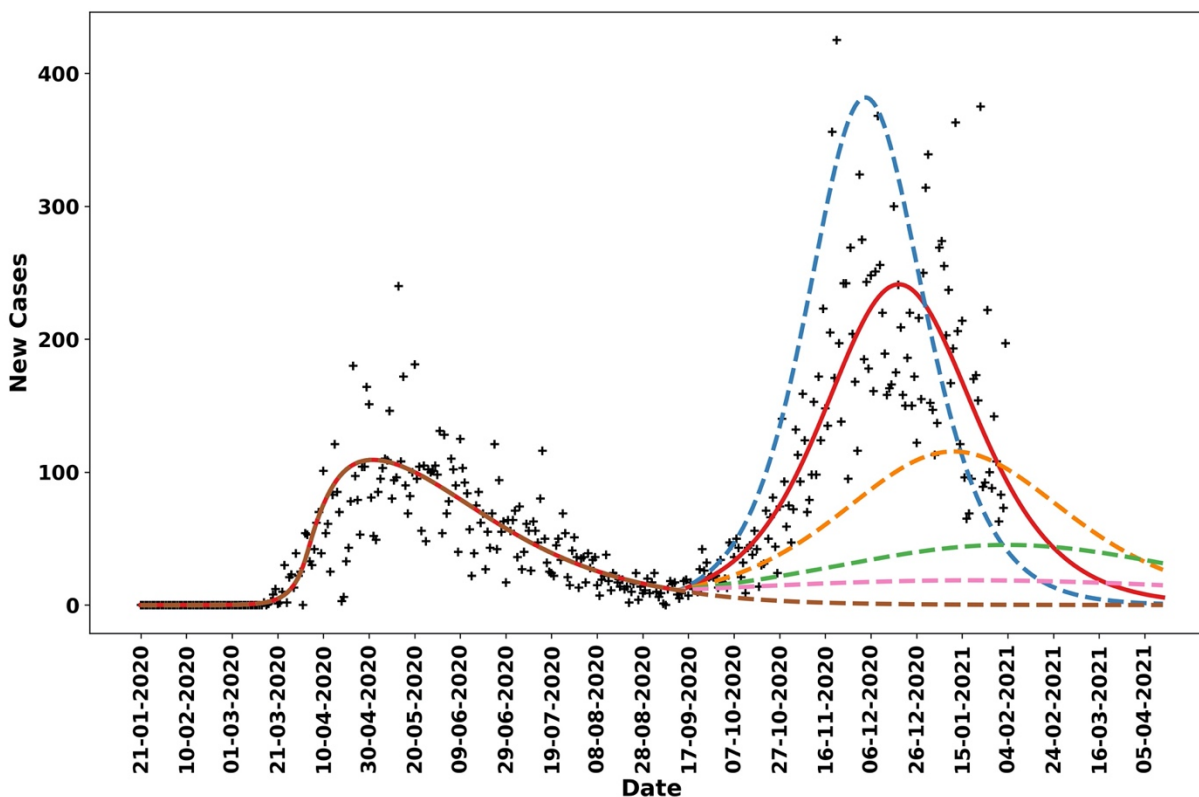

512

513

514 Figure 6: Model-derived projections for various scenarios in which the NPI parameter  $p_1$ , which  
515 indicates the fraction of the population practicing disease-avoiding behaviors in a second NPI  
516 phase in the Navajo Nation starting 14-September-2020, was adjusted to identify the threshold  
517 required to prevent a second surge in cases. The red solid line corresponds to the MAP estimate  
518 for  $p_1$ , which is approximately 0.19. The blue broken line indicates the predicted trajectory for  
519 daily cases when  $p_1$  is fixed at 0.15. The orange broken line corresponds to a scenario wherein  
520  $p_1$  is fixed at 0.22, the green broken line corresponds to a scenario wherein  $p_1$  is fixed at 0.25,  
521 the pink broken line corresponds to a scenario wherein  $p_1$  is fixed at 0.27, and the brown broken  
522 line corresponds to a scenario wherein  $p_1$  is fixed at 0.35.

523

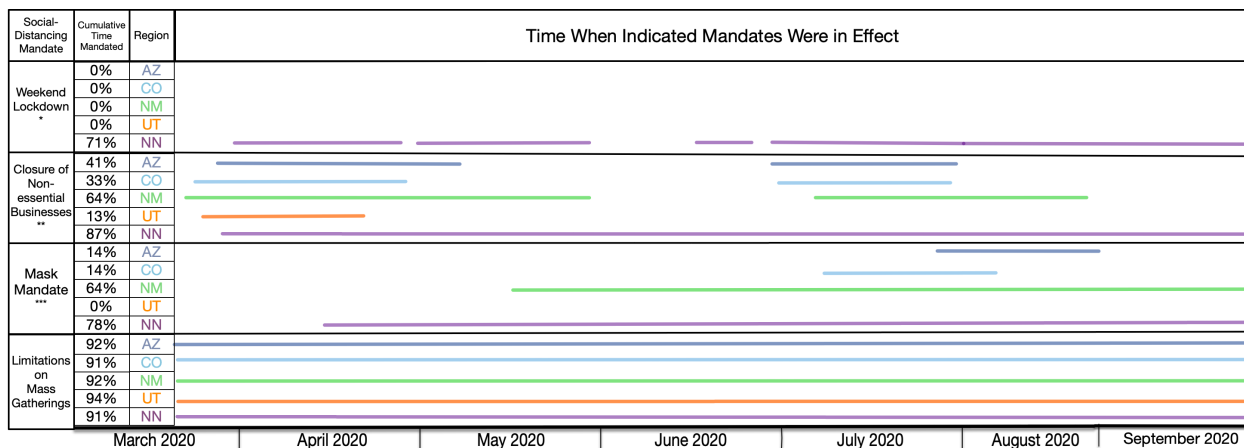

524

525

526 Figure 7: Timeline for mandated NPIs in the Navajo Nation and surrounding states between 01-  
 527 March-2020 and 14-September-2020. Each region is represented by a different color, as  
 528 indicated. Only mandates issued by state governors and the president of the Navajo Nation are  
 529 considered.