

Genetic Underpinnings and Audiological Characteristics in Children with Unilateral Sensorineural Hearing Loss

Chen-Yu Lee¹, MD, Pei-Hsuan Lin², MD, Yu-Ting Chiang^{2,3}, MS, Cheng-Yu Tsai^{2,3}, MS, Shu-Yu Yang², You-Mei Chen⁴, Chao-Hsuan Li⁴, Chun-Yi Lu^{5,6}, MD, PhD, Tien-Chen Liu^{2,6}, MD, PhD, Chuan-Jen Hsu^{2,7}, MD, PhD, Pei-Lung Chen^{3,4}, MD, PhD, Jacob Shujui Hsu³, PhD, Chen-Chi Wu^{2,8,9}, MD, PhD.

¹Department of Otolaryngology, National Taiwan University Hospital, Hsinchu Branch, Hsinchu, Taiwan

²Department of Otolaryngology, National Taiwan University Hospital, Taipei, Taiwan

³Graduate Institute of Medical Genomics and Proteomics, College of Medicine, National Taiwan University, Taipei, Taiwan

⁴Department of Medical Genetics, National Taiwan University Hospital, Taipei, Taiwan

⁵Division of Pediatric Infectious Diseases, Department of Pediatrics, National Taiwan University Hospital, Taipei, Taiwan

⁶College of Medicine, National Taiwan University, Taipei, Taiwan

⁷Department of Otorhinolaryngology, Taichung Tzu Chi Hospital, Buddhist Tzu Chi Medical Foundation, Taichung, Taiwan

⁸Department of Medical Research, National Taiwan University Hospital, Hsinchu Branch, Hsinchu, Taiwan

⁹Hearing and Speech Center, National Taiwan University Hospital, Taipei, Taiwan

Corresponding Authors:

Jacob Shujui Hsu, Ph.D., Graduate Institute of Medical Genomics and Proteomics, College of Medicine, National Taiwan University, 2, Xuzhou Rd., Zhongzheng Dist., Taipei 100, Taiwan (R.O.C.)

Email: jacobhsu@ntu.edu.tw

Chen-Chi Wu, MD, Ph.D., Department of Otolaryngology, National Taiwan University Hospital, 7, Zhongshan S. Rd., Zhongzheng Dist., Taipei 100, Taiwan (R.O.C.)

Email: chenchiwu@ntuh.gov.tw

Keywords

Unilateral sensorineural hearing loss, *GJB2*, *EDNRB*, *PAX3*, next-generation sequencing

Declaration of Conflicting Interests

The Authors declare that there is no conflict of interest.

Author Contributions

Chen-Yu Lee, concept and design; analysis and interpretation of data; statistical analysis; drafting of the manuscript; Pei-Hsuan Lin, acquisition and interpretation of data; statistical analysis; critical revision of the manuscript; Yu-Ting Chiang, analysis and interpretation of data; Cheng-Yu Tsai, analysis and interpretation of data; Shu-Yu Yang, analysis and interpretation of data; of audiograms; You-Mei Chen, performing NGS; performing Sanger sequencing; Chao-Hsuan Li, performing NGS; performing Sanger sequencing; Chun-Yi Lu, acquisition of data; providing clinical advice; Tien-Chen Liu, acquisition of data; providing clinical advice; Chuan-

Jen Hsu, acquisition of data; providing clinical advice; Pei-Lung Chen, acquisition of data; providing clinical and experimental advice; Jacob Shujui Hsu, providing advice for data analysis; critical revision of the manuscript; Chen-Chi Wu, acquisition and interpretation of data; critical revision of the manuscript; supervising the whole study.

Funding

This study was supported by research grants from the National Health Research Institute (NHRI-EX111-10914PI) and the National Science and Technology Council (110-2314-B-002-189-MY3), Taiwan.

Abstract

Objective: Unilateral sensorineural hearing loss is a condition commonly encountered in otolaryngology clinics. However, its molecular pathogenesis remains unclear. This study aimed to investigate the genetic underpinnings of childhood unilateral sensorineural hearing loss and analyze the associated audiological features.

Study Design: Retrospective analysis of a prospectively recruited cohort

Setting: Tertiary referral center

Methods: We enrolled 38 children with unilateral sensorineural hearing loss and performed physical, audiological, imaging, and congenital cytomegalovirus examinations as well as genetic testing using next-generation sequencing targeting 30 deafness genes. The audiological results were compared across different etiologies.

Results: Causative genetic variants were identified in eight (21.1%) patients, including five with *GJB2* variants, two with *PAX3* variants, and one with *EDNRB* variant. *GJB2* variants were associated with mild-to-moderate unilateral sensorineural hearing loss in various audiogram configurations, whereas *PAX3* and *EDNRB* variants were associated with profound unilateral sensorineural hearing loss in flat audiogram configurations. In addition, whole genome sequencing and extended next-generation sequencing targeting 213 deafness genes were performed in two multiplex families compatible with autosomal recessive inheritance; yet no definite causative variants were identified. Cochlear nerve deficiency and congenital cytomegalovirus infection were observed in nine and two patients without definite genetic diagnoses.

Conclusion: Genetic underpinnings can contribute to approximately 20% of childhood unilateral sensorineural hearing loss, and different genotypes are associated with various audiological

features. These findings highlight the utility of genetic examinations in guiding the diagnosis, counseling, and treatment of unilateral sensorineural hearing loss in children.

Introduction

Unilateral sensorineural hearing loss (USNHL) is an otologic disorder characterized by hearing impairment in one ear, with preserved audiometric thresholds in the contralateral ear ¹. USNHL occurs in approximately 1 in 1000 live newborns and may increase in prevalence with age as delayed-onset forms ²⁻⁴. Various degrees of hearing loss ranging from mild to profound hearing impairment and progression in both severity and laterality have been observed in children with USNHL ⁵. The etiology of USNHL in children differs from that of bilateral sensorineural hearing loss (SNHL). Etiological research showed that 40–66% of children with bilateral SNHL is attributed to genetic causes ^{6,7}. In contrast, common causes of USNHL include developmental anomalies in the cochlear nerve or inner ear (~40%) ^{5,6} and congenital cytomegalovirus (cCMV) infection (~10%) ⁸.

Identifying the molecular basis is crucial for predicting outcomes and enabling personalized medicine in children with SNHL ⁹. Although USNHL has been occasionally reported in patients with Waardenburg syndrome (WS) ¹⁰ and some types of non-syndromic SNHL (such as variants in the *GJB2*, *GJB3*, *TECTA*, and *COCH* genes) ¹¹, the genetic underpinnings have not been comprehensively investigated in children with USNHL. The lack of knowledge regarding molecular etiology hinders the consultation and prognosis of specific treatments for USNHL in children, such as cochlear implantation (CI) ¹². To address these difficulties, this study aimed to elucidate the genetic underpinnings of USNHL using next-generation sequencing (NGS) and further correlate audiological manifestations with genotypes to facilitate clinical management.

Methods

Research Ethics and Patient Consent

This study was conducted in accordance with the principles of the Declaration of Helsinki. This study was approved by the Research Ethics Committee of the National Taiwan University Hospital (IRB number:201803092RINB). All the participants or their parents provided written informed consent.

Patient Recruitment

We included children (<18 years) who underwent NGS-based genetic examinations for USNHL at National Taiwan University Hospital between January 1, 2018, and December 31, 2021. Diagnoses of USNHL were made by experienced otologists based on audiological data and medical records of each patient. Patients with conductive or mixed-type hearing impairment or those lacking complete medical records were excluded from this study.

Audiological Tests

Pure tone audiometry (PTA) or diagnostic auditory brainstem response (ABR) was used in audiological assessments depending on the age and cognitive status of the patients¹³. The first available audiometric test results, either of PTA or ABR, were ascertained to determine the hearing level by averaging the hearing thresholds of 0.5, 1, 2, and 4 kHz. USNHL was defined as a 4-tone hearing level of 25 dB or more in the worse ear and a 4-tone hearing level of less than 25 dB in the contralateral ear¹⁴. Furthermore, the severity of SNHL was categorized as mild (25–40 dB), moderate (41–70 dB), severe (71–95 dB), or profound (>95 dB) according to the

patient's 4-tone hearing level. Audiogram configurations were classified as flat, sloping, high-tone hearing loss, or others ¹⁵.

Genetic Examination

Peripheral blood samples were obtained from the participants to extract genomic DNA from mononuclear cells, followed by an NGS-based genetic examination targeting 30 common deafness genes ¹⁶. Through shared decision-making for family study design, the multiplex family USNHL-12 underwent whole genome sequencing (WGS), and the multiplex family USNHL-13 received an extended NGS diagnostic encompassing 213 deafness genes (see **supplemental information S1**). Paired-end reads from the sequencing were aligned, sorted, and detected for single-nucleotide variants (SNVs) and small insertions and deletions (Indels) using Sentieon DNaseq version 2018 ¹⁷. The identified variants were further annotated using ANNOVAR version 2019 ¹⁸ and classified according to the 2015 the American College of Medical Genetics and Genomics (ACMG) criteria ¹⁹. Variants meeting the criteria of pathogenic or likely pathogenic variants were recorded as possible disease-causing variants and confirmed through Sanger sequencing. Finally, a genetic diagnosis was made for participants harboring pathogenic or likely pathogenic variants if their genotypes were compatible with the inheritance mode of the affected gene described in Online Mendelian Inheritance in Man (OMIM) ²⁰. A complete list of the equipment, gene panel, and bioinformatics analysis methods applied in this study is shown in **supplemental information S1**.

Imaging Studies

High-resolution computed tomography (HRCT) of the temporal bone or magnetic resonance imaging (MRI) of the brains were performed for the imaging examination. The decision to obtain images and the choice of imaging modality were individualized per patient and made by the shared decision-making process. A pediatric neuroradiologist and an otologist (C.-C.W.) interpreted the images according to the morphological features of the cochlea, vestibule, semicircular canal, vestibular aqueduct, cochlear aperture, and cochlear nerve. Cochlear nerve deficiency (CND) is defined as the absence or reduction in the caliber of the cochlear nerve compared with the facial nerve⁹.

Congenital CMV Testing

Urine CMV isolation tests were performed to confirm cCMV infection. Candidates for the test were those younger than 3 months of age with suspicion of infection after being evaluated by their pediatricians or otolaryngologists.

Statistical Analysis

Statistical analyses were performed using the R software (version 4.0.5). Categorical data were summarized as numbers (percentages) and analyzed using Fisher's exact test. Continuous data were analyzed using the Wilcoxon rank-sum test. Statistical significance was set at $P < 0.05$ (2-sided).

Results

Demographic Data

A total of 38 patients (36 families) with USNHL were included in this study (**Table 1**). The genetic diagnosis was achieved in eight patients (8/38, 21.1%). The mean [standard deviation] age of the patients who were genetically diagnosed (GD) with UHSNL was 3.4 [3.5] years, while that of those who were genetically undiagnosed (GUD) was 3.8 [4.5] years. No differences in age and sex distributions were observed between patients in the GD and GUD groups. Furthermore, no statistical difference in laterality and hearing severity was observed between patients in the GD and GUD groups. The audiological data for each patient are detailed in **Supplemental Table S1**.

Sixteen patients (16/38 = 42.1%) underwent imaging studies (2 in the GD group and 14 in the GUD group). CND was identified in 9 (64.3%) of the 14 patients in the GUD group; however, no other types of inner ear malformations were detected in this cohort. CMV tests were performed on 10 patients. Among them, 2 patients who were GUD (2/10, 20%) with profound hearing loss (USNHL-16 and USNHL-21) showed positive urine CMV cultures. Moreover, USNHL-16 had CND, whereas USNHL-21 did not (**Table 1** and **Supplemental Table S1**). The etiology of USNHL remained indefinite in 19 patients (19/38, 50.0%), regardless of comprehensive genetic, imaging, and CMV workups. The distribution of etiological causes in the 38 patients is illustrated in **Supplemental Figure S1**.

Genotypes and Phenotypic Features of the Patients in the GD Group (n = 8)

Causative genetic variants were identified in eight patients in the GD group, including five (5/8 = 62.5%) with *GJB2* (OMIM 121011) variants, two (2/8 = 25.0%) with *PAX3* (OMIM 606597) variants, and one (1/8 = 12.5%) with *EDNRB* (OMIM 131244) variant (**Table 1**). Four patients were homozygous for the *GJB2* NM_004004.6:c.109G>A (p.Val37Ile) variant, and one had

compound heterozygous NM_004004.6:c.[109G>A];[235del] variants. Three patients were GD with WS and distinct heterozygous variants²¹. USNHL-6-II-1 had a splice site *EDNRB* variant, NC_000013.10(NM_001201397.1):c.754-2A>G, and exhibited heterochromia iridis in addition to hearing impairment. USNHL-7 and USNHL-8, who carried *PAX3* variant NC_000002.12(NM_013942.4): c.587-2A>G and c.1130C>G (p.Ser377Cys), respectively, presented with hearing impairment without additional WS-specific manifestations (**Table 2**).

All patients who were GD with *GJB2* variants presented with either mild or moderate USNHL, while those with variants related to WS showed profound USNHL with scaled-out thresholds (**Figure 1**). *GJB2* variants were associated with different audiogram configurations, whereas variants related to WS were associated with a flat audiogram configuration. Noticeably, the mother of USNHL-6-II-1 was identified to have the same pathogenic *EDNRB*:c.754-2A>G variant; however, she did not express any WS symptoms (**Figure 2a & 2b**), suggesting a variant with incomplete penetrance and expressivity. MRI of USNHL-6-II-1 revealed normal cochlear nerves and cochlea in the affected ear (**Figure 2c & 2d**).

Two multiplex families presenting USNHL

In the family USNHL-12, dizygotic twins II-2 and II-3 exhibited profound hearing impairment on the right side with a flat audiogram configuration (**Figure 3**). In the family USNHL-13, II-1 and II-2 showed moderate hearing impairment with different audiogram configurations²². No progression in severity or laterality and changes in audiogram configurations were noted during the follow-up period in all four patients. No causative variants were identified through WGS in the family USNHL-12 and targeted NGS of 213 deafness genes in the family USNHL-13.

Discussion

In this study, we achieved genetic diagnoses in 8 (21.1%) of the 38 children with USNHL. Five causative variants of *GJB2*, *EDNRB*, and *PAX3* were detected, and different genotypes were associated with distinct audiological features. In addition, two multiplex families compatible with autosomal recessive inheritance were speculated to have genetic causes despite lacking a definite genetic diagnosis. We also demonstrated that imaging studies and CMV testing could help in identifying the etiology of USNHL in patients without a definite genetic diagnosis.

GJB2 encodes connexin26 (Cx26), which acts as the building block of gap junctions and plays an essential role in homeostasis in the organ of Corti²³. Defects in Cx26 may interfere with the normal structure and functional maturation of the cochlea, which may lead to hearing loss in mice^{23,24}. In humans, recessive variants of *GJB2* are the most common causes of non-syndromic SNHL²⁵. Among these, *GJB2*:c.109G>A and c.235delC are the two predominant variants in the East Asian population⁷. *GJB2*:c.109G>A is associated with mild to moderate SNHL with incomplete penetrance, whereas c.235delC is associated with severe-to-profound SNHL^{26,27}. Noticeably, USNHL occurred in 4% of the c.109G>A homozygotes and 5% of the *GJB2*:c.[109G>A];[235del] compound heterozygotes²⁶. Moreover, it has been reported that patients with USNHL with either c.109G>A homozygosity or c.[109G>A];[235del] compound heterozygosity might progress to more severe or bilateral forms of USNHL^{26,28}.

In this study, we identified four patients with USNHL with *GJB2*:c.109G>A homozygosity and one with *GJB2*:c.[109G>A];[235del] compound heterozygosity (**Table 2**). All five patients retained unilateral mild-to-moderate SNHL during at least 6 months of follow-ups. Previous studies have shown that bilateral SNHL caused by homozygous c.109G>A may exhibit diverse ages of onset and affect different frequency ranges^{26,29}. Considering the progressive nature of

SNHL associated with c.109G>A, longer follow-up periods might be required to confirm that the unilaterality of SNHL persisted in our five patients. Nonetheless, our results demonstrate that the genetic contribution of *GJB2* variants should not be overlooked in clinical practice, particularly in children with mild-to-moderate USHNL.

WS is a genetic disorder characterized by auditory and pigmentary abnormalities³⁰. Six genes have been confirmed to be responsible for WS: *PAX3*³¹, *MITF* (OMIM*156845)³², *SOX10* (OMIM*602229)³³, *EDN3* (OMIM*131242)³⁴, *EDNRB*³⁵, and *SNAI2* (OMIM*602150)³⁶. Defects in the WS genes were found to affect the differentiation and development of neural crest cells (NCCs) into intermediate cells (ICs) in the stria vascularis (SV)^{37,38}. Abnormalities in ICs lead to aberrant homeostasis of potassium ions in the endolymph, which may dysregulate the endolymphatic environment, leading to hair cell apoptosis and eventually SNHL³⁹⁻⁴¹. USNHL has been reported in several WS studies^{42,43}. Song et al. reported in a meta-analysis study that 10.6% of patients with WS had SNHL were unilateral and demonstrated that USNHL in WS might be gene-dependent; USNHL was presented in 20.0–28.6% of patients with WS with *PAX3*, *EDNRB*, or *END3* variants and was shown in only 0–10.5% of patients with WS with *MITF*, *SOX10*, or *SNAI2* variants⁴⁴. Furthermore, genetic background and modifiers were suspected to be involved in the penetrance of SNHL in WS, contributing to diverse audiologic phenotypes, including USNHL⁴³.

In this study, two patients harbored likely pathogenic variants in *PAX3* and one harbored a pathogenic *EDNRB* variant. All three patients with WS presented with scaled-out USNHL (**Figure 1**). These findings were consistent with those of previous reports that while the severity of WS in patients varied within and between families, profound SNHL was the most common audiological phenotype³⁷.

Notably, both multiplex families (USNHL-12 and 13) with USNHL showed a recessive mode of inheritance (**Figure 3**). Although no disease-causing SNVs or Indels were identified through our WGS and extended targeted NGS in these two families, the genetic contribution to USNHL could not be excluded. USNHL is believed to affect approximately 1 in 1,000 newborns congenitally⁴⁵. Therefore, the hereditary roots of USNHL must be statistically justified if more than one case is found in the same family⁴⁶. Given the limitations of the current NGS-based diagnostic platforms⁴⁷, the genetic underpinnings of the two families could be structural variants, pathogenic variants in novel deafness genes, or disease-causing intronic variants.

For patients without a definite genetic diagnosis in this study, CND accounted for 64.3% of their etiologies, and cCMV infection was responsible for a small proportion of USNHL cases (**Supplemental Figure S1**). Our results are compatible with previous findings that CND and inner ear malformations are common causes of USNHL⁴⁸. Nevertheless, there may still be genetic determinants that underlie these two origins. For example, CND has been reported in patients with CHARGE, VACTERL, and Coffin-Siris syndromes⁴⁹⁻⁵¹, which are hereditary and associated with USNHL⁵². Furthermore, multiple genes have been documented involved in inner ear malformations in syndromic and non-syndromic SNHL^{53,54}. Therefore, considering the aggregation of patients with USNHL in multiplex families and the potential association between USNHL and genetics-related inner ear malformations, it is inferred that the genetic component of USNHL may be higher than the 21.1% demonstrated in this study.

The management of USNHL in children who cannot attain binaural hearing using conventional hearing aids remains controversial. CI has shown benefits in restoring binaural hearing in children with profound USNHL^{55,56}; however, the Food and Drug Administration has only approved CI in patients aged 5 years or older¹². One of the concerns regarding CI in prelingual

children with USNHL arises from its uncertain outcomes. Structural anomalies, such as CND and inner ear malformations, which are common etiologies of USNHL in children, may lead to limited benefits with CI⁵⁷. In contrast, patients with prelingual WS with profound USNHL may be good candidates for CI. First, as the main pathogenetic mechanism of WS is NCC dysfunction in the stria vascularis, and the pathology is confined to the inner ear, the cochlear nerve and cochlea are intact for CI stimulation, as demonstrated in the imaging study of our USNHL-6-II-1 patient. Furthermore, except for *SOX10* variants, patients with most types of WS do not exhibit inner ear malformations⁴⁴. As such, favorable CI outcomes have been reported in patients with WS with bilateral SNHL⁵⁸. It is conceivable that with the same pathogenetic mechanisms, favorable CI outcomes can be anticipated in patients with WS with USNHL. In contrast, patients with *GJB2* variants may only require observation or hearing aids because of the slow progression and mild-to-moderate severity of SNHL²⁸. Taken together, the identification of genetic causes may assist in precision medicine by tailoring clinical assessment and treatment protocols for children with USNHL.

In this study, we demonstrated the utility of genetic examination in delineating the molecular causes of USNHL and clarified specific genotype-phenotype correlations that can facilitate the assessment, counseling, and management of children with USNHL in clinical practice. However, this study has several limitations that deserve further discussion. First, the NGS diagnostics adopted in this study only screened for exonic and splice site variants in 30 common deafness genes. Therefore, pathogenic variants of other uncommon deafness genes were not addressed. Similarly, copy number variations (CNVs)⁵⁹ and variants in non-coding regions⁶⁰ were beyond the scope of the NGS diagnostics used in this study. Second, the generalizability of this study could be limited due to the relatively small cohort size of 38 patients from a single Han

Taiwanese population. Nonetheless, the diagnostics and cohort size limitations did not compromise our findings regarding the role of genetic factors in childhood USNHL.

In conclusion, we confirmed that genetic underpinnings could contribute to approximately 20% of childhood USNHL and demonstrated that different genotypes were associated with different audiologic features and outcomes. These findings indicate the potential utility of including genetic examination in the evaluation battery for childhood USNHL, as the identification of the genetic etiology can help guide appropriate counseling and management of the disease.

Acknowledgments

We thank all the patients and their relatives participating in this study. The high-coverage targeted next-generation sequencing data was generated at the Laboratory of Molecular Genetic Diagnostics at the National Taiwan University Hospital. We also thank National Center for High-performance Computing (NCHC) for providing computational and storage resources.

Declaration of Conflicting Interests

The Authors declare that there is no conflict of interest.

Data Availability

All data produced in the present study are available upon reasonable request to the authors.

References

1. F. B. *Workshop Proceedings: National Workshop on Mild and Unilateral Hearing Loss*. . https://www.cdc.gov/ncbddd/hearingloss/documents/unilateral/Mild_Uni_2005-Workshop_Proceedings.pdf. Published 2005. Accessed 8 October 2022.
2. Lieu JEC, Tye-Murray N, Fu Q. Longitudinal study of children with unilateral hearing loss. *The Laryngoscope*. 2012;122(9):2088-2095.
3. Ross DS, Visser SN, Holstrum WJ, Qin T, Kenneson A. Highly Variable Population-Based Prevalence Rates of Unilateral Hearing Loss After the Application of Common Case Definitions. *Ear and Hearing*. 2010;31(1).
4. Lieu JEC. Permanent Unilateral Hearing Loss (UHL) and Childhood Development. *Curr Otorhinolaryngol Rep*. 2018;6(1):74-81.
5. van Beeck Calkoen EA, Sanchez Aliaga E, Merkus P, et al. High prevalence of abnormalities on CT and MR imaging in children with unilateral sensorineural hearing loss irrespective of age or degree of hearing loss. *International Journal of Pediatric Otorhinolaryngology*. 2017;97:185-191.
6. van Beeck Calkoen EA, Engel MSD, van de Kamp JM, et al. The etiological evaluation of sensorineural hearing loss in children. *Eur J Pediatr*. 2019;178(8):1195-1205.
7. Usami SI, Nishio SY. The genetic etiology of hearing loss in Japan revealed by the social health insurance-based genetic testing of 10K patients. *Hum Genet*. 2022;141(3-4):665-681.
8. Paul A, Marlin S, Parodi M, et al. Unilateral Sensorineural Hearing Loss: Medical Context and Etiology. *Audiol Neurootol*. 2017;22(2):83-88.
9. Lee C-Y, Lin P-H, Tsai C-Y, et al. Comprehensive Etiologic Analyses in Pediatric Cochlear Implantees and the Clinical Implications. *Biomedicines*. 2022;10(8):1846.

10. Read AP, Newton VE. Waardenburg syndrome. *Journal of Medical Genetics*. 1997;34(8):656-665.
11. Dodson KM, Georgolios A, Barr N, et al. Etiology of unilateral hearing loss in a national hereditary deafness repository. *American Journal of Otolaryngology*. 2012;33(5):590-594.
12. Benchetrit L, Ronner EA, Anne S, Cohen MS. Cochlear Implantation in Children With Single-Sided Deafness: A Systematic Review and Meta-analysis. *JAMA Otolaryngology–Head & Neck Surgery*. 2021;147(1):58-69.
13. Lin P-H, Hsu C-J, Lin Y-H, et al. Etiologic and Audiologic Characteristics of Patients With Pediatric-Onset Unilateral and Asymmetric Sensorineural Hearing Loss. *JAMA Otolaryngology–Head & Neck Surgery*. 2017;143(9):912-919.
14. Golub JS, Lin FR, Lustig LR, Lalwani AK. Prevalence of adult unilateral hearing loss and hearing aid use in the United States. *The Laryngoscope*. 2018;128(7):1681-1686.
15. Wu C-C, Chen Y-S, Chen P-J, Hsu C-J. Common Clinical Features of Children With Enlarged Vestibular Aqueduct and Mondini Dysplasia. *The Laryngoscope*. 2005;115(1):132-137.
16. Wu CC, Tsai CY, Lin YH, et al. Genetic Epidemiology and Clinical Features of Hereditary Hearing Impairment in the Taiwanese Population. *Genes*. 2019;10(10).
17. Kendig KI, Baheti S, Bockol MA, et al. Sentieon DNaseq Variant Calling Workflow Demonstrates Strong Computational Performance and Accuracy. *Front Genet*. 2019;10:736.
18. Wang K, Li M, Hakonarson H. ANNOVAR: functional annotation of genetic variants from high-throughput sequencing data. *Nucleic Acids Research*. 2010;38(16):e164-e164.

19. Richards S, Aziz N, Bale S, et al. Standards and guidelines for the interpretation of sequence variants: a joint consensus recommendation of the American College of Medical Genetics and Genomics and the Association for Molecular Pathology. *Genet Med.* 2015;17(5):405-424.
20. Amberger JS, Hamosh A. Searching Online Mendelian Inheritance in Man (OMIM): A Knowledgebase of Human Genes and Genetic Phenotypes. *Curr Protoc Bioinformatics.* 2017;58:1.2.1-1.2.12.
21. Lee C-Y, Lo M-Y, Chen Y-M, et al. Identification of nine novel variants across PAX3, SOX10, EDNRB, and MITF genes in Waardenburg syndrome with next-generation sequencing. *Molecular Genetics & Genomic Medicine.* n/a(n/a):e2082.
22. Pittman AL, Stelmachowicz PG. Hearing loss in children and adults: audiometric configuration, asymmetry, and progression. *Ear Hear.* 2003;24(3):198-205.
23. Wu X, Zhang W, Li Y, Lin X. Structure and Function of Cochlear Gap Junctions and Implications for the Translation of Cochlear Gene Therapies. *Front Cell Neurosci.* 2019;13:529.
24. Zhao HB. Hypothesis of K(+)-Recycling Defect Is Not a Primary Deafness Mechanism for Cx26 (GJB2) Deficiency. *Front Mol Neurosci.* 2017;10:162.
25. Kenna MA, Feldman HA, Neault MW, et al. Audiologic phenotype and progression in GJB2 (Connexin 26) hearing loss. *Archives of otolaryngology--head & neck surgery.* 2010;136(1):81-87.
26. Shen J, Oza AM, Del Castillo I, et al. Consensus interpretation of the p.Met34Thr and p.Val37Ile variants in GJB2 by the ClinGen Hearing Loss Expert Panel. *Genet Med.* 2019;21(11):2442-2452.

27. Guo C, Huang S-S, Yuan Y-Y, et al. Hearing Phenotypes of Patients with Hearing Loss Homozygous for the *GJB2* c.235delc Mutation. *Neural Plasticity*. 2020;2020:8841522.
28. Wu CC, Tsai CH, Hung CC, et al. Newborn genetic screening for hearing impairment: a population-based longitudinal study. *Genet Med*. 2017;19(1):6-12.
29. Chai Y, Chen D, Sun L, et al. The homozygous p.V37I variant of *GJB2* is associated with diverse hearing phenotypes. *Clinical genetics*. 2015;87(4):350-355.
30. Nayak CS, Isaacson G. Worldwide distribution of Waardenburg syndrome. *Ann Otol Rhinol Laryngol*. 2003;112(9 Pt 1):817-820.
31. Bondurand N, Pingault V, Goerich DE, et al. Interaction among *SOX10*, *PAX3* and *MITF*, three genes altered in Waardenburg syndrome. *Hum Mol Genet*. 2000;9(13):1907-1917.
32. Lautenschlager NT, Milunsky A, DeStefano A, Farrer L, Baldwin CT. A novel mutation in the *MITF* gene causes Waardenburg syndrome type 2. *Genet Anal*. 1996;13(2):43-44.
33. Iso M, Fukami M, Horikawa R, Azuma N, Kawashiro N, Ogata T. *SOX10* mutation in Waardenburg syndrome type II. *Am J Med Genet A*. 2008;146a(16):2162-2163.
34. Pingault V, Bondurand N, Lemort N, et al. A heterozygous endothelin 3 mutation in Waardenburg-Hirschsprung disease: is there a dosage effect of *EDN3/EDNRB* gene mutations on neurocristopathy phenotypes? *J Med Genet*. 2001;38(3):205-209.
35. Issa S, Bondurand N, Faubert E, et al. *EDNRB* mutations cause Waardenburg syndrome type II in the heterozygous state. *Hum Mutat*. 2017;38(5):581-593.
36. Otręba M, Miliński M, Buszman E, Wrześniok D, Beberok A. [Hereditary hypomelanocytoses: the role of *PAX3*, *SOX10*, *MITF*, *SNAI2*, *KIT*, *EDN3* and *EDNRB* genes]. *Postepy Hig Med Dosw (Online)*. 2013;67:1109-1118.

37. Pingault V, Ente D, Dastot-Le Moal F, Goossens M, Marlin S, Bondurand N. Review and update of mutations causing Waardenburg syndrome. *Hum Mutat.* 2010;31(4):391-406.
38. Matsushima Y, Shinkai Y, Kobayashi Y, Sakamoto M, Kunieda T, Tachibana M. A mouse model of Waardenburg syndrome type 4 with a new spontaneous mutation of the endothelin-B receptor gene. *Mamm Genome.* 2002;13(1):30-35.
39. Liu H, Li Y, Chen L, et al. Organ of Corti and Stria Vascularis: Is there an Interdependence for Survival? *PLoS One.* 2016;11(12):e0168953.
40. Du Y, Ren LL, Jiang QQ, et al. Degeneration of saccular hair cells caused by MITF gene mutation. *Neural Dev.* 2019;14(1):1.
41. Tachibana M, Kobayashi Y, Matsushima Y. Mouse models for four types of Waardenburg syndrome. *Pigment Cell Res.* 2003;16(5):448-454.
42. Barashkov NA, Romanov GP, Borisova UP, et al. A rare case of Waardenburg syndrome with unilateral hearing loss caused by nonsense variant c.772C>T (p.Arg259*) in the MITF gene in Yakut patient from the Eastern Siberia (Sakha Republic, Russia). *International Journal of Circumpolar Health.* 2019;78(1):1630219.
43. Kim SH, Kim AR, Choi HS, et al. Molecular Etiology of Hereditary Single-Side Deafness: Its Association With Pigmentary Disorders and Waardenburg Syndrome. *Medicine.* 2015;94(43).
44. Song J, Feng Y, Acke FR, Coucke P, Vleminckx K, Dhooge IJ. Hearing loss in Waardenburg syndrome: a systematic review. *Clin Genet.* 2016;89(4):416-425.
45. Brown KD, Dillon MT, Park LR. Benefits of Cochlear Implantation in Childhood Unilateral Hearing Loss (CUHL Trial). *Laryngoscope.* 2022;132 Suppl 6(Suppl 6):S1-s18.

46. Everberg G. Further Studies on Hereditary Unilateral Deafness. *Acta Oto-Laryngologica*. 1960;51(5-6):615-635.
47. Ye K, Hall G, Ning Z. Structural variation detection from next generation sequencing. *Next Generat Sequenc & Applic*. 2016;1(007).
48. Johansson M, Karltorp E, Edholm K, Drott M, Berninger E. A Prospective Study of Etiology and Auditory Profiles in Infants with Congenital Unilateral Sensorineural Hearing Loss. *Journal of Clinical Medicine*. 2022;11(14):3966.
49. Blake KD, Prasad C. CHARGE syndrome. *Orphanet Journal of Rare Diseases*. 2006;1(1):34.
50. Alburaiiky S, Taylor J, O'Grady G, et al. Cochlear nerve deficiency in SOX11-related Coffin-Siris syndrome. *American Journal of Medical Genetics Part A*. 2022;188(8):2460-2465.
51. Rudić M, Wong W, Viner S, Strachan D, Raine C. Bilateral cochlear nerve absence in a 3 year old child with VACTERL association. *International Journal of Pediatric Otorhinolaryngology*. 2017;93:71-74.
52. Haffey T, Fowler N, Anne S. Evaluation of unilateral sensorineural hearing loss in the pediatric patient. *International Journal of Pediatric Otorhinolaryngology*. 2013;77(6):955-958.
53. Rost S, Bach E, Neuner C, et al. Novel form of X-linked nonsyndromic hearing loss with cochlear malformation caused by a mutation in the type IV collagen gene COL4A6. *European Journal of Human Genetics*. 2014;22(2):208-215.
54. Brotto D, Sorrentino F, Cenedese R, et al. Genetics of Inner Ear Malformations: A Review. *Audiology Research*. 2021;11(4):524-536.

55. Ehrmann-Mueller D, Kurz A, Kuehn H, et al. Usefulness of cochlear implantation in children with single sided deafness. *Int J Pediatr Otorhinolaryngol.* 2020;130:109808.
56. Thomas JP, Neumann K, Dazert S, Voelter C. Cochlear Implantation in Children With Congenital Single-Sided Deafness. *Otol Neurotol.* 2017;38(4):496-503.
57. Buchman CA, Teagle HF, Roush PA, et al. Cochlear implantation in children with labyrinthine anomalies and cochlear nerve deficiency: implications for auditory brainstem implantation. *Laryngoscope.* 2011;121(9):1979-1988.
58. Cullen RD, Zdanski C, Roush P, et al. Cochlear Implants in Waardenburg Syndrome. *The Laryngoscope.* 2006;116(7):1273-1275.
59. Shearer AE, Kolbe DL, Azaiez H, et al. Copy number variants are a common cause of non-syndromic hearing loss. *Genome Medicine.* 2014;6(5):37.
60. Avraham KB, Khalaily L, Noy Y, Kamal L, Koffler-Brill T, Taiber S. The noncoding genome and hearing loss. *Human Genetics.* 2022;141(3):323-333.

Figure and Supplemental Legends:

Figure. 1 The audiograms of the eight patients who were genetically diagnosed with USNHL. The audiograms of patients: USNHL-1, USNHL-2, USNHL-6-II-1, and USNHL-7 were transformed from their auditory brainstem responses. All the audiograms were used for patients' USNHL diagnosis. Abbreviations: USNHL, unilateral sensorineural hearing loss; *GJB2*, gap junction beta-2; *EDNRB*, endothelin receptor type B; *PAX3*, paired box 3

Figure. 2 The pedigree, Sanger sequence, and MRI of USNHL-6-II-1 with Waardenburg syndrome. a, USNHL-6-II-1 has sensorineural hearing loss and heterochromia iridis and mother

does not express any phenotypes of Waardenburg syndrome while harboring the same variants as he does. b, Sanger sequencing results of the patient (upper sequence) and his mother (lower sequence). c, Oblique sagittal view of the MRI shows a normal-sized left cochlear nerve (arrowhead) compared with the facial nerve (white arrow). d, Axial view of the MRI shows normal cochlear anatomy in USNHL-6-II-1 (arrowhead). Abbreviations: USNHL, unilateral sensorineural hearing loss; MRI, magnetic resonance imaging

Figure. 3 Pedigrees and audiograms of the two multiplex families.

Supplemental Figure. 1 Pie chart illustrating the etiologies of the 38 patients with USNHL. Abbreviations: cCMV, congenital cytomegalovirus infection; USNHL, unilateral sensorineural hearing loss

Table 1 Demographic Characteristics of 38 Patients with USNHL^a

Characteristic	Genetically diagnosed (n = 8)	Genetically undiagnosed (n = 30)	P-value^b
Age, mean (SD) [range], y	3.4 (3.5) [0.5 – 10.7]	3.8 (4.5) [0.1 – 15.2]	0.976
Age group			
< 1 y	2 (25.0)	14 (46.7)	0.570
1 – 10 y	5 (62.5)	12 (40.0)	
10 – 18 y	1 (12.5)	4 (13.3)	
Sex			
Male	3 (37.5)	15 (50.0)	0.696
Female	5 (62.5)	15 (50.0)	
Affected ear			
Right	2 (25.0)	15 (50.0)	0.257
Left	6 (75.0)	15 (50.0)	
Severity			
Mild	2 (25.0)	5 (16.7)	0.496
Moderate	3 (37.5)	5 (16.7)	
Severe	0 (0.0)	2 (6.6)	
Profound	3 (37.5)	18 (60.0)	
Gene			
<i>GJB2</i>	5 (62.5)	N/A	N/A
<i>EDNRB</i>	1 (12.5)	N/A	
<i>PAX3</i>	2 (25.0)	N/A	
Multiplex family ^c	0 ^c	2 (100.0)	N/A

Table 1 (continued)

Imaging finding			
Cochlear nerve deficiency	0 (0.0)	9 (64.3)	N/A ^d
Cochlear malformation	0 (0.0)	0 (0.0)	
Normal	2 (100.0)	5 (35.7)	
CMV			
Positive	0 (0.0)	2 (22.2)	N/A ^e
Negative	1 (100.0)	7 (77.8)	

deviation; USNHL, unilateral sensorineural hearing loss; *GJB2*, gap junction beta-2; *PAX3*, paired box 3; *EDNRB*, endothelin receptor type B; CMV, cytomegalovirus, N/A, not applicable

^a Data are expressed as number (percentage) of patients if not otherwise stated.

^b P-value is calculated by Wilcoxon rank-sum test or Fisher's exact test.

^c Patients from the same multiplex family were regarded as 1 family, and there was no multiplex family recruited in the genetically diagnosed group.

^d A statistical test is not performed as not all patients received imaging study.

^e A statistical test is not performed as not all patients received CMV urine testing.

Table 2 Causative Variants Identified in the 8 Patients with USNHL

Subjects	Variant profile						ACMG criteria	Severity
	Gene	Variants	Structure	Protein change	Zygotity ^a			
USNHL-1	<i>GJB2</i>	NM_004004.6: c.109G>A, Missense	Exon	p.Val37Ile	1/1		PP5,PM1,PM5, PS1, PP2 (P)	Mild
USNHL-2	<i>GJB2</i>	NM_004004.6: c.109G>A, Missense	Exon	p.Val37Ile	1/1		PP5,PM1,PM5,PS1, PP2 (P)	Mild
USNHL-3	<i>GJB2</i>	NM_004004.6: c.109G>A, Missense	Exon	p.Val37Ile	1/1		PP5,PM1,PM5,PS1, PP2 (P)	Moderate
USNHL-4	<i>GJB2</i>	NM_004004.6: c.109G>A, Missense	Exon	p.Val37Ile	1/1		PP5,PM1,PM5,PS1, PP2 (P)	Moderate
USNHL-5	<i>GJB2</i>	NM_004004.6: c.109G>A, Missense NM_004004.6: c.235del, Frameshift	Exon Exon	p.Val37Ile p.Leu79CysfsTer3	Compound heterozygous		PP5,PM1,PM5,PS1, PP2 (P, GJB2:c.G109A) PS3, PVS1,PP5,PM2 (P, GJB2:c.235del)	Moderate
USNHL-6-II-1	<i>EDNRB</i>	NC_000013.10(NM_001201397.1):c.754-2A>G, Splice site	Intron	N/A	0/1		PVS1, PM2 (P)	Profound
USNHL-7	<i>PAX3</i>	NC_000002.12(NM_013942.4): c.587-2A>G, Splice site	Intron	N/A	0/1		PVS1, PM2 (LP)	Profound
USNHL-8	<i>PAX3</i>	NM_181459.4: c.1130C>G, Missense	Exon	p.Ser377Cys	0/1		PM2, PP2, PP3 (LP)	Profound

Abbreviations: USNHL, unilateral hearing loss; *GJB2*, gap junction beta-2; *EDNRB*, endothelin receptor type B; *PAX3*, paired box 3; MAF, minor allele frequency; TB, Taiwan Biobank; ACMG, American College of Medical Genetics and Genomics; N/A, not applicable or not available; P, pathogenic; LP, likely pathogenic

^a 0/1: heterozygous; 1/1: alternative homozygous

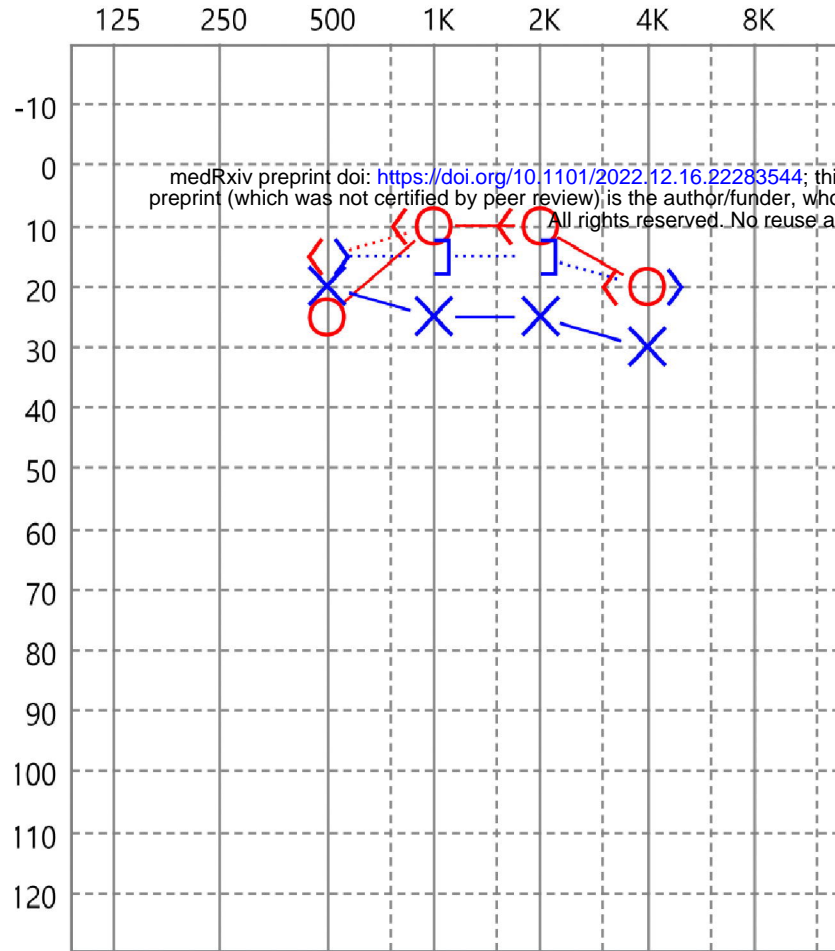

USNHL-1
GJB2

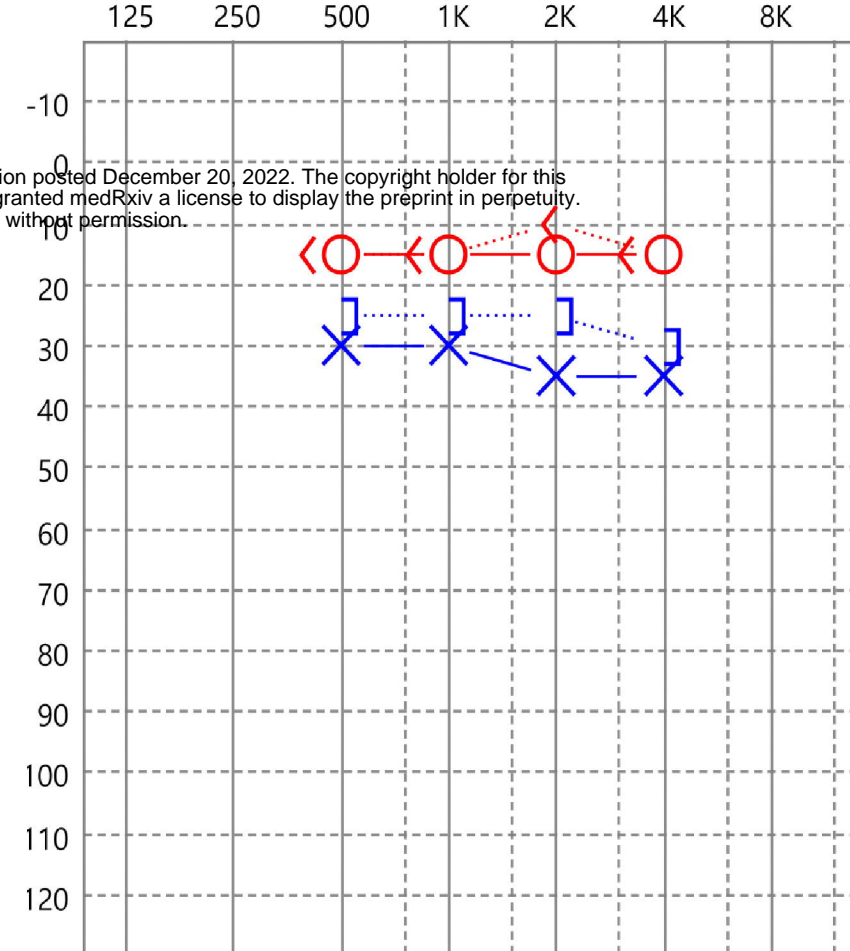

USNHL-2
GJB2

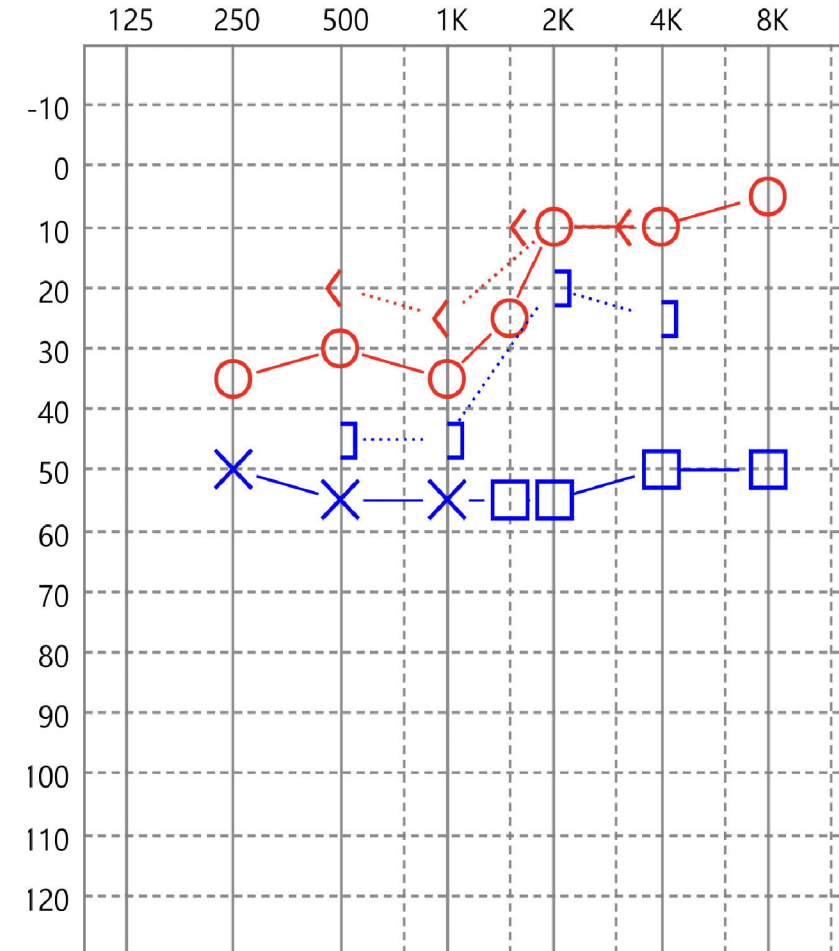

USNHL-3
GJB2

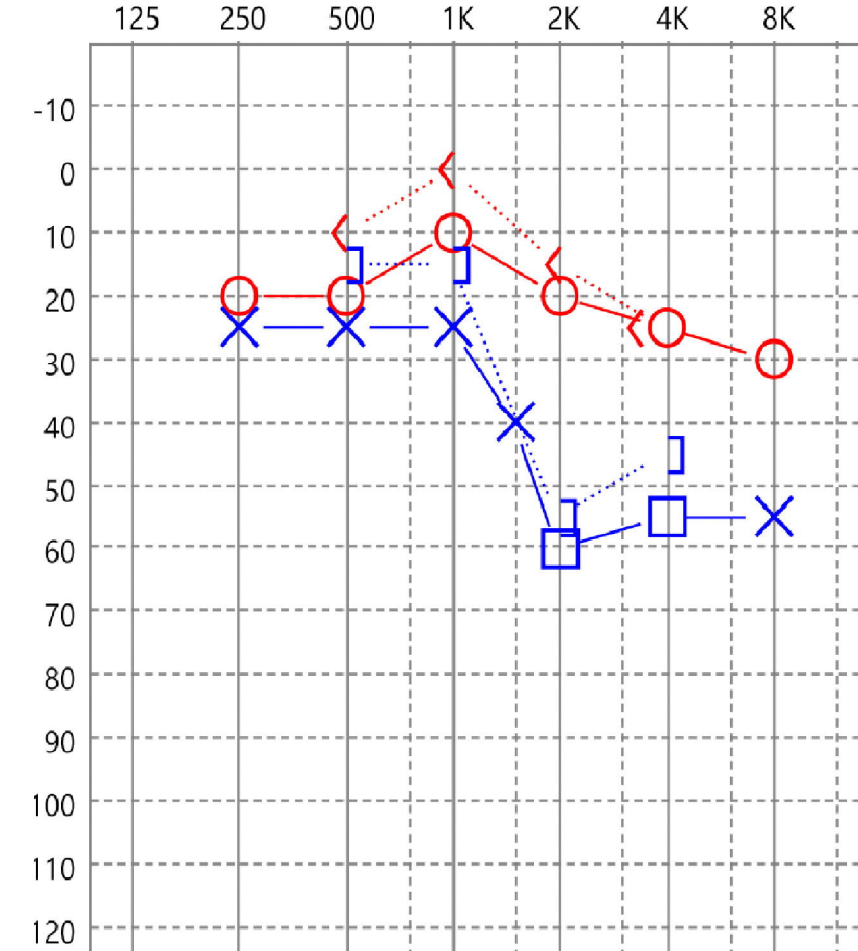

USNHL-4
GJB2

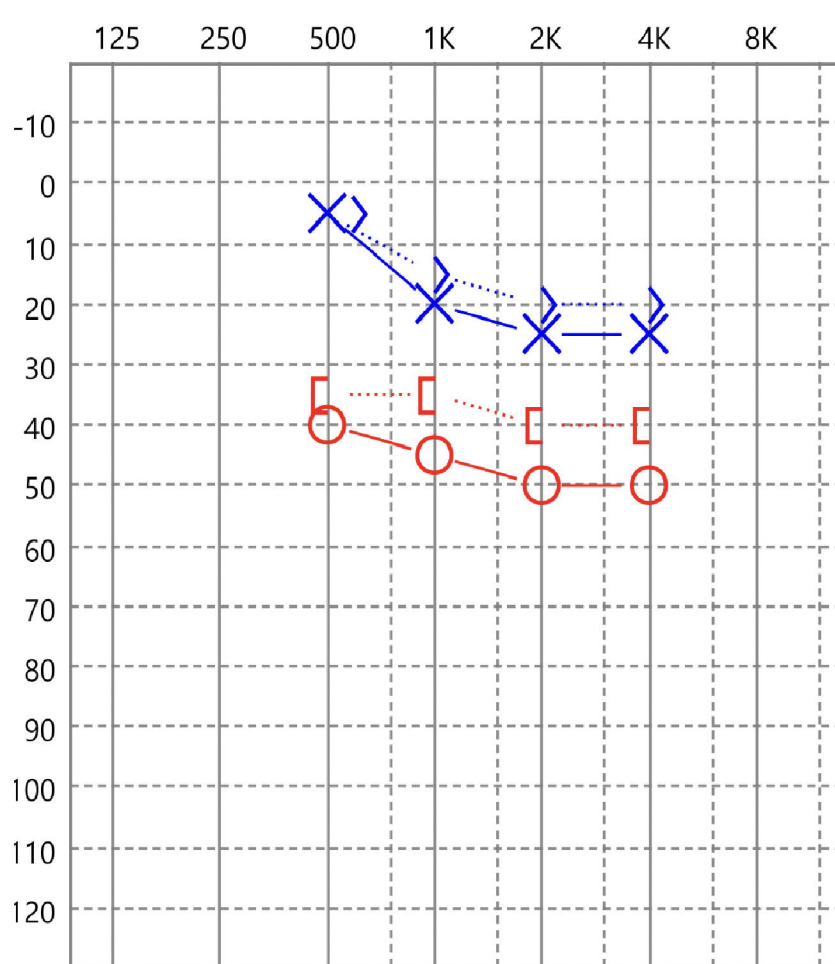

USNHL-5
GJB2

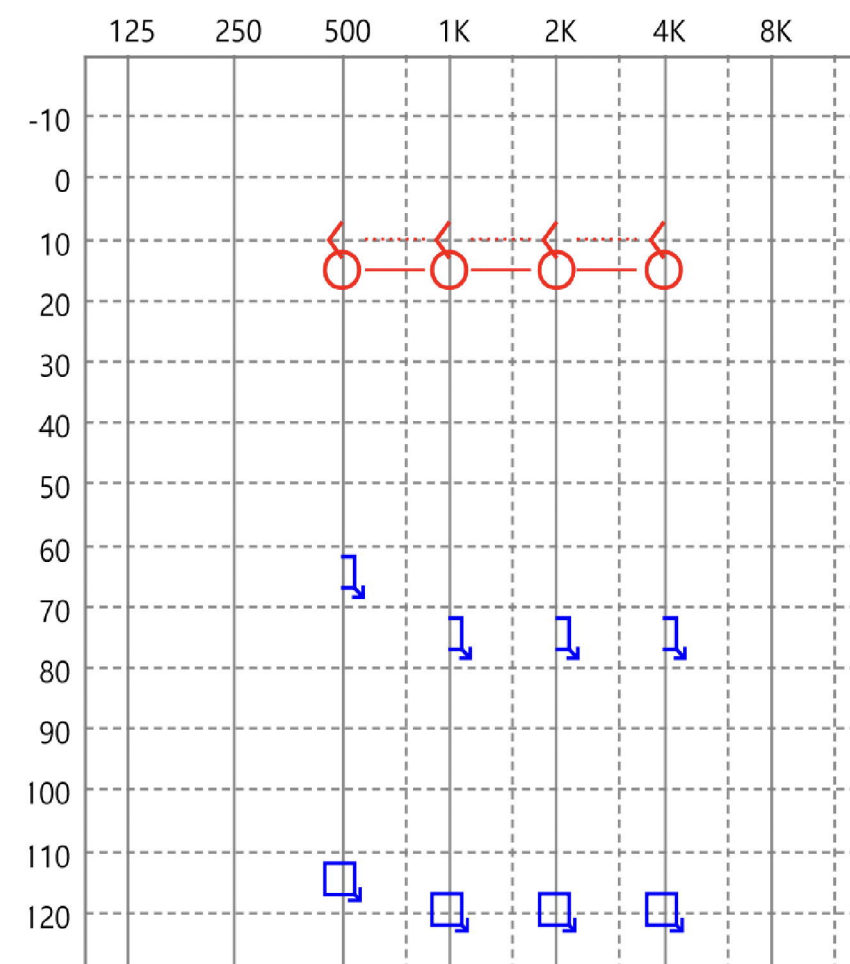

USNHL-6-II-1
EDNRB

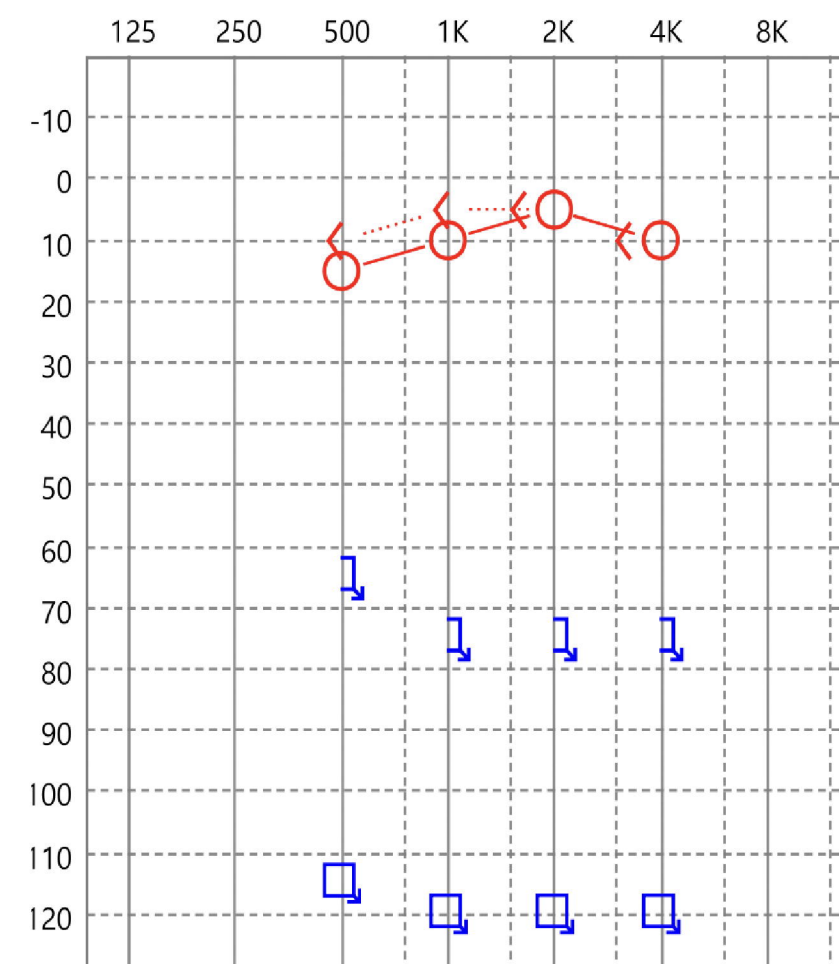

USNHL-7
PAX3

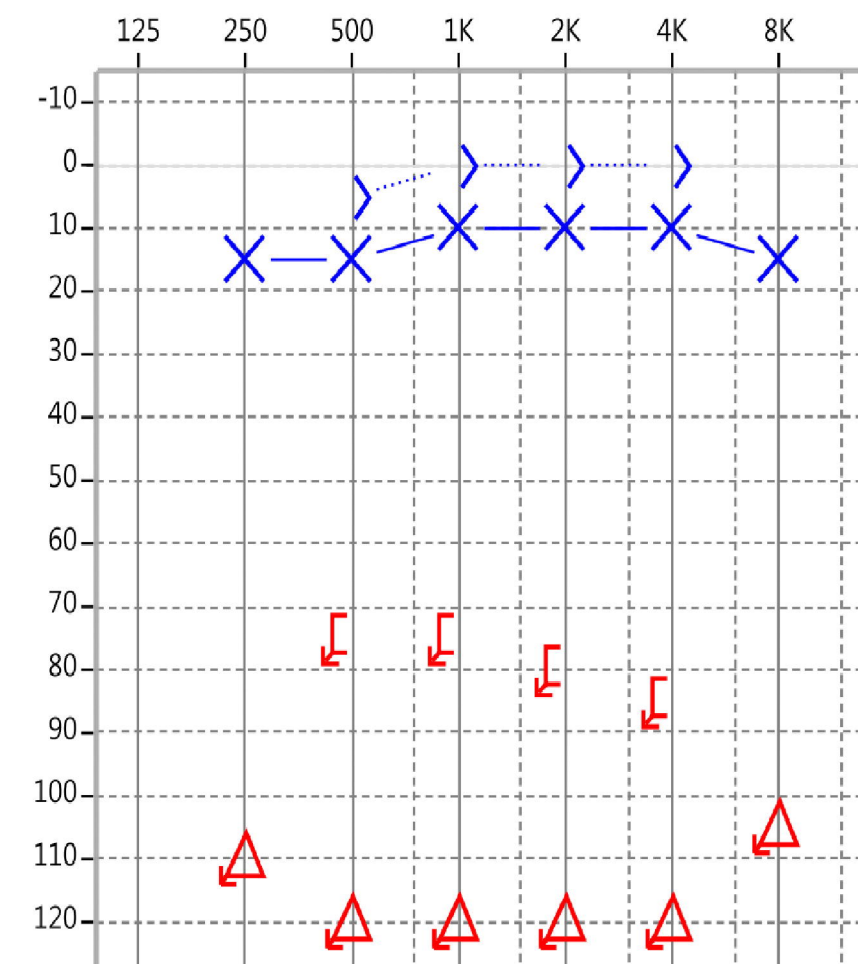

USNHL-8
PAX3

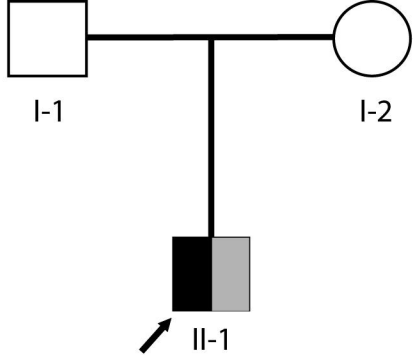

a

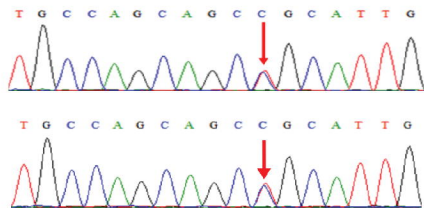

b

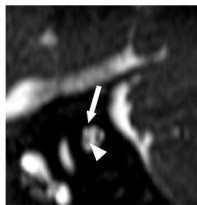

c



d

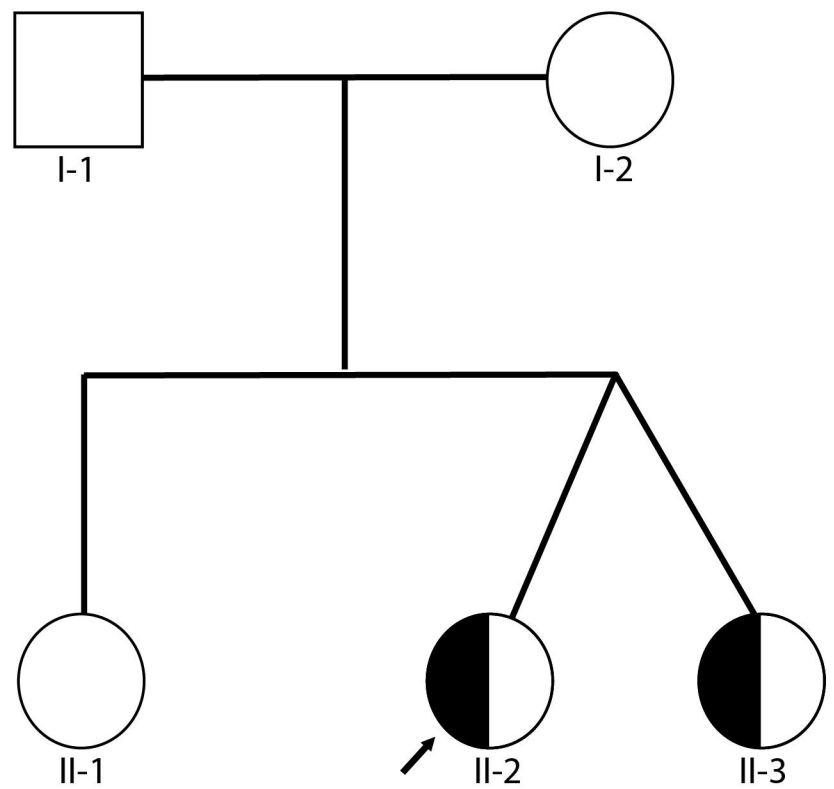

a USNHL-12

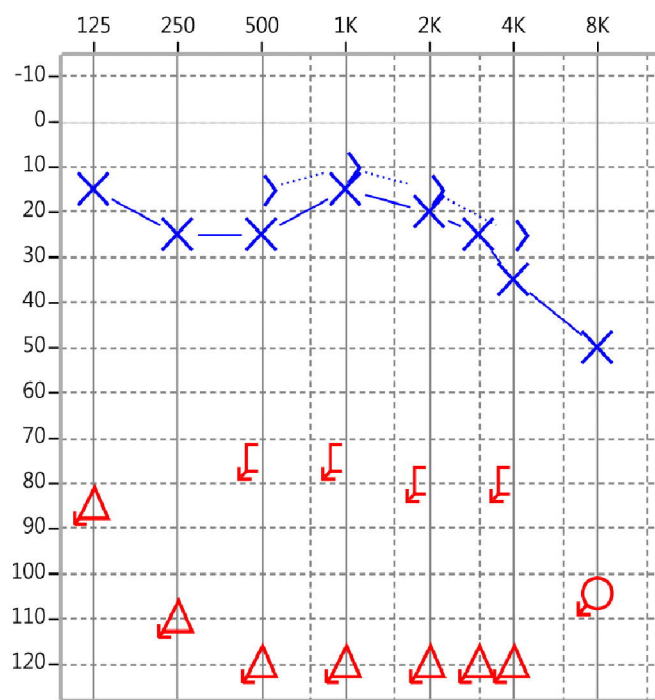

USNHL-12-II-2

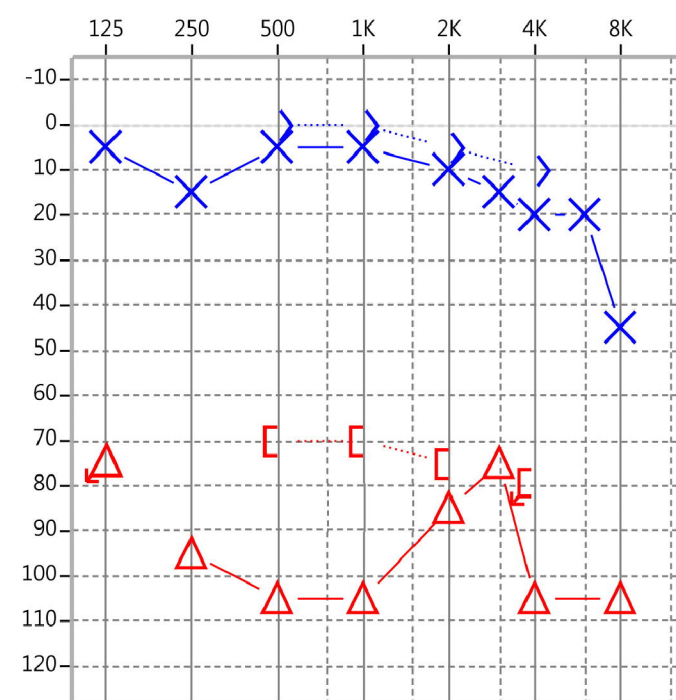

USNHL-12-II-3

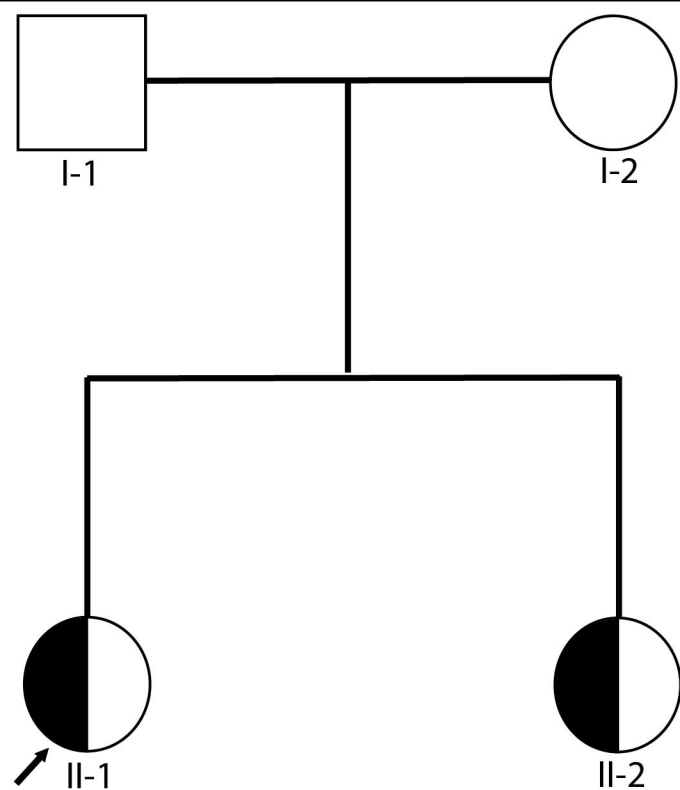

b USNHL-13

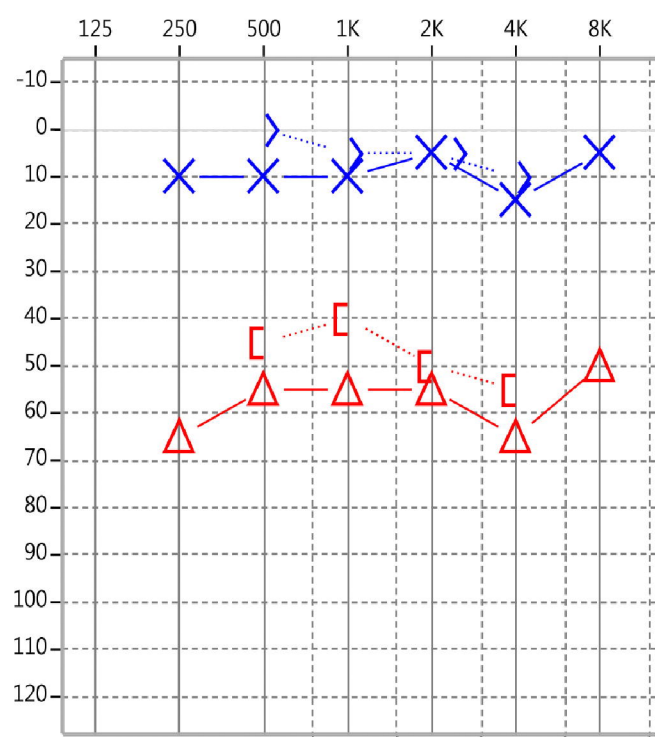

USNHL-13-II-1

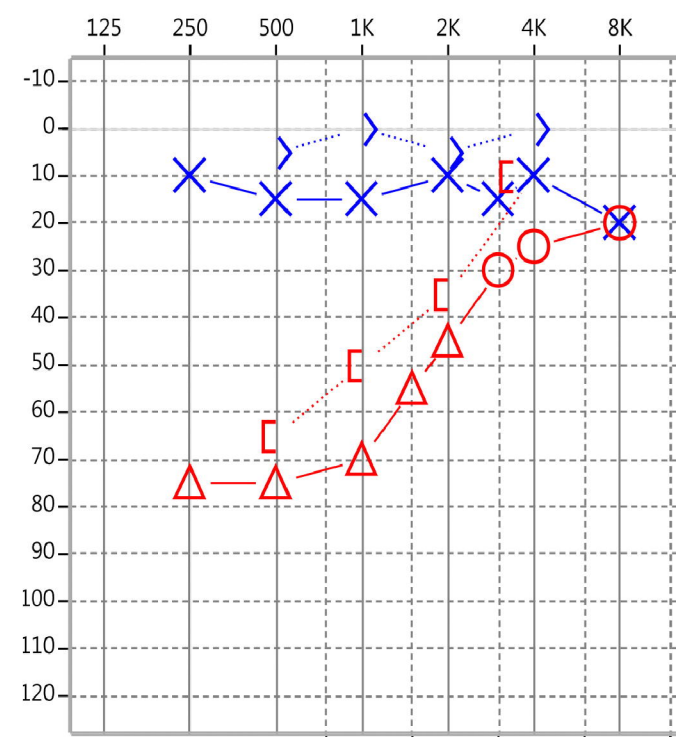

USNHL-13-II-2