

## **Immune system and blood-brain barrier-wide biomarker analyses provide causal evidence for autoimmunity in dementia**

Joni V. Lindbohm, MD, PhD;<sup>1,2</sup> Nina Mars, MD, PhD;<sup>3</sup> Pyry N. Sipilä, MD, PhD;<sup>2</sup> Prof. Archana Singh-Manoux;<sup>1,4</sup> Heiko Runz, MD, PhD;<sup>5,6</sup> *FinnGen*; <sup>3</sup> Prof. Gill Livingston;<sup>7,8</sup> Prof. Sudha Seshadri;<sup>9,10,11,12</sup> Prof. Ramnik Xavier;<sup>13,14</sup> Prof. Aroon D. Hingorani;<sup>15,16,17</sup> Prof. Samuli Ripatti;<sup>2,3,18\*</sup> Prof. Mika Kivimäki<sup>1,2\*</sup>

<sup>1</sup> Department of Epidemiology and Public Health, University College London, 1-19 Torrington Place, London, UK

<sup>2</sup> CliniCUM, Department of Public Health, University of Helsinki, P.O. Box 41, FI-00014 Helsinki, Finland

<sup>3</sup> Institute for Molecular Medicine Finland (FIMM), HiLIFE, University of Helsinki, Helsinki, Finland

<sup>4</sup> Université de Paris, Inserm U1153, Epidemiology of Ageing and Neurodegenerative diseases, Paris, France

<sup>5</sup> Molecular Medicine Partnership Unit (MMPU), University of Heidelberg/EMBL, Heidelberg, Germany

<sup>6</sup> Translational Biology, Biogen Inc, Cambridge, MA, USA

<sup>7</sup> Division of Psychiatry, University College London, London, UK

<sup>8</sup> Camden and Islington NHS Foundation Trust, London, UK

<sup>9</sup> Glenn Biggs Institute of Alzheimer's and Neurodegenerative Diseases, University of Texas Health Science Center, San Antonio, TX, USA.

<sup>10</sup> Boston University School of Public Health, Boston, MA, USA.

<sup>11</sup> New York University Grossman School of Medicine, New York, NY, USA.

<sup>12</sup> Boston University School of Medicine, Boston, MA, USA.

<sup>13</sup> Center for Computational and Integrative Biology, Massachusetts General Hospital and Harvard Medical School, Boston, MA, USA

<sup>14</sup> Department of Molecular Biology, Massachusetts General Hospital and Harvard Medical School, Boston, MA, USA

<sup>15</sup> Institute of Cardiovascular Science, University College London, London, UK

\* This preprint reports new research that has not been certified by peer review and should not be used to guide clinical practice.

<sup>16</sup> University College London, British Heart Foundation Research Accelerator, London, UK.

<sup>17</sup> Health Data Research UK, London, UK.

<sup>18</sup> Broad Institute of the Massachusetts Institute of Technology and Harvard University, Cambridge, MA, USA

\* Authors contributed equally

Correspondence to Dr Joni Lindbohm, Clinicum, Department of Public Health, University of Helsinki, P.O. Box 41, FI-00014 Helsinki, Finland; E-mail address: [joni.lindbohm@helsinki.fi](mailto:joni.lindbohm@helsinki.fi); Telephone: +358 9 1911 Fax: +358 9 191 27 600

## Abstract

Immune system and blood brain barrier (BBB) dysfunction are implicated in the development of Alzheimer's disease and other dementias, but their causal role remains unknown. We performed Mendelian randomization (MR) for over 43,643 immune system and BBB-related biomarkers and identified 126 potential causal risk factors for dementias. A phenome-wide analysis using MR-based polygenic risk score in FinnGen study (N=339,233) for these risk factors revealed a common genetic background for dementias and autoimmune diseases which was supported by further HLA analyses. Pathway analyses linked the 126 proteins to amyloid- $\beta$ , tau and  $\alpha$ -synuclein pathways, increased inflammatory responses, and altered self-tolerance mechanisms. In inverse-probability-weighted analyses simulating randomized controlled drug trials in observational data, anti-inflammatory and immunosuppressive medications were associated with reduced dementia risk ( $p < 0.01$  for methotrexate and TNF- $\alpha$  inhibitors). These converging results from different research lines suggest that autoimmunity is a modifiable component in diseases causing dementia.

## 1 **Background**

2  
3 Dysregulation of peripheral and central immune systems and chronic neuroinflammation occur in  
4 diseases, such as severe infections and autoimmune diseases that relate to increased risk of  
5 dementia.<sup>1-3</sup> In central immune system, neuroinflammation can closely relate to sustained activation  
6 of microglia, the resident immune cells in the central nervous system (CNS), and lead to  
7 neurodegeneration and increased deposition of plaques and tangles.<sup>1-3</sup> When CNS encounters  
8 infections, trauma, or toxins, microglia are key in the acute immune response and in this phase are  
9 neuroprotective. When the microglia activation continues, this leads to chronic production of pro-  
10 inflammatory products including reactive oxygen species, nitric oxide, and cytokines.<sup>1-3</sup> This in turn  
11 may exacerbate disease-specific pathology, such as amyloid  $\beta$  and tau protein in Alzheimer's  
12 disease, and neurodegeneration.<sup>1</sup>

13  
14 In addition, the peripheral immune system and blood brain barrier are thought to be important in the  
15 development of dementias.<sup>1,4</sup> Because of the crosstalk between the central and peripheral immune  
16 system and BBB, the causal factors linking inflammation to dementias may originate from any of  
17 these systems. Chronic peripheral inflammation, from low-grade systemic inflammation<sup>5,6</sup> and  
18 infections,<sup>7</sup> can disrupt BBB so that it allows neurotoxic and pro-inflammatory plasma components  
19 and pathogens to enter CNS.<sup>4</sup> Dysfunctional BBB may also promote peripherally driven  
20 neuroinflammation by increasing endothelial adhesion molecules and chemokines and migration of  
21 peripheral leukocytes to CNS.<sup>4</sup> These processes expose CNS to prolonged neuroinflammation and  
22 subsequent neurodegeneration,<sup>1</sup> although the role of centrally and peripherally driven CNS  
23 autoimmunity in dementias remains unclear.<sup>8-11</sup> In addition, there is limited data to confirm the  
24 causal nature of these hypothesised mechanisms.<sup>1-3</sup>

25  
26 Mendelian randomization (MR), using large GWAS libraries for unconfounded genetic proxies for  
27 biomarkers, and triangulation, combining multiple research methods with different sources of  
28 strengths and biases to identify convergent evidence, improve validity of causal estimates and  
29 success rate in drug development.<sup>12,13</sup> Although a range of studies on the immune system and BBB  
30 have been conducted,<sup>1-4</sup> to the best of our knowledge, there are currently no published large-scale,  
31 immune system and BBB-wide MR analyses, confirmed by triangulation to identify novel drug  
32 targets and risk factors for dementias.

33  
34 In this study, we analyse biomarkers of immune system and BBB (**Figure 1**) and use MR to study  
35 potential causal associations with five outcomes (Alzheimer's disease, Parkinson's diseases,  
36 frontotemporal dementia, vascular dementia, and poor cognitive performance) and triangulate the  
37 results. We identify several novel associations between inflammatory and immune checkpoint-  
38 related biomarkers and dementias. Using single nucleotide polymorphisms (SNPs) strongly  
39 associated with these biomarkers, we create MR-based polygenic risk scores (PRS) for the diseases.  
40 In phenome-wide association analyses (PheWAS) for the PRSs, we observe shared genetic risk  
41 factors with autoimmune diseases and dementias, which are supported by HLA analysis. In line  
42 with this, our pathway analyses for risk factors identified in MR show enrichment in inflammatory  
43 and self-tolerance related processes, which are in close interaction with amyloid  $\beta$ , tau protein, and  
44  $\alpha$ -synuclein. Lastly, using inverse-probability-weighted (IPW) survival analysis to simulate a

45 randomized controlled trial design in observational data with up to 20 years of follow-up, we  
46 identify anti-inflammatory medications which may lower the risk of dementias. In summary, we  
47 detect several novel risk factors and potential drug targets for dementia-causing diseases in a  
48 triangulation framework and propose that dementias may have an autoimmune component which is  
49 modifiable with anti-inflammatory medication. These findings are set out in **Figure 2**.

50  
51

## 52 **Results**

53

### 54 **Mendelian randomization and proteomics analyses**

55 In the discovery step, we used MR to identify potential causal risk factors for dementias. The MR-  
56 base search provided 30,913 components for the immune system and 12,730 components for BBB;  
57 254 immune system components and 132 BBB components passed the false discovery rate (FDR)  
58 of 5% (**Figure 1**). After removal of duplicates, 126 unique biomarkers were associated (p-value  
59  $<0.000502$ ) with neurodegenerative diseases in MR analyses using Wald ratio (when only 1 or 2  
60 SNPs was available) or inverse variance-weighted method (when 3 or more SNPs were available)  
61 (**Figure 3A and B**). MR sensitivity analyses showed no strong evidence of reverse causality, and  
62 evidence of horizontal pleiotropy for only two outcomes. (**STable 1 and SFigures 1A and B**). The  
63 126 biomarkers (FDR  $<5\%$ ) showed few off-target associations, mainly with type 1 diabetes and  
64 LDL-C. (**SFigure 2**).

65

66 While most biomarkers were disease-specific, 8 were associated with Alzheimer's disease, vascular  
67 dementia, and poor cognitive performance. The SNPs for the latter biomarkers were centred within  
68 500 kilobases (kb) from *APOE* gene, one of the strongest genetic risk factors for late-onset  
69 Alzheimer's disease (**SFile 1**). To differentiate the effects of these biomarkers from *APOE*, we  
70 studied dementia outcomes and plasma proteins measured within the Whitehall II cohort (N=6,235).  
71 Out of the 8 proteins, 2 were associated with all-cause dementia in a 20-year follow-up and 1  
72 (IFIT2) of these remained after adjustment of *APOE* status (**SFigure 3**; data on dementia subtypes  
73 were not available).

74

75 The 118 outcome-specific biomarkers did not show similar enrichment around high-risk genes for  
76 Alzheimer's disease such as *APP*, *PSEN1*, *PSEN2*, *ADAM10*, *TREM2*, *PLD3*, and *UNC5C*. Instead,  
77 they were characterized by inflammatory, chemokine, complement, and adhesion processes (C1Q,  
78 C1R, C4B, CCL1, CDHR5, GPNMB, IL1 $\beta$ , IL17, IL27, IL37, LTBR, PTP1B, SIGIRR), antigen  
79 presenting and immune checkpoints (HLA-DR, HLA-DQ, BAFFR, C1R, C1Q, CD11, CD19,  
80 CD20, CD33, CD40, CX3CR1, PD-1, and PDL-1), and BBB tight junction related biomarkers  
81 (TJP, AIMP1, BIN1).

82

### 83 **Polygenic risk score and HLA analysis**

84 To study the diseases that share common genetic background with dementias, we created MR-based  
85 polygenic risk score (PRS) using the SNPs of the 126 biomarkers for dementias and then run a  
86 phenome-wide association analysis (PheWAS) (**Figure 4**). After linkage disequilibrium (LD)  
87 pruning and SNP matching in FinnGen (N=339,233), 92 SNPs were available for a PRS for

88 Alzheimer's disease (the number of SNPs for other outcomes was insufficient,  $\leq 25$ ). The PRS was  
89 strongly and positively associated with risk of all types of dementia-causing diseases (except  
90 Parkinson's disease) and autoimmune disorders, such as rheumatic diseases, type 1 diabetes and its  
91 complications. The PRS was also associated with increased risk of thyroiditis, coronary heart  
92 disease, hyperlipidaemia, and the likelihood of having medications for Crohn's disease (indicating  
93 disease severity), but reduced risk of cancers. We studied whether HLA-types that predispose to  
94 autoimmune diseases are also associated with dementias. These analyses showed 21 directionally  
95 consistent HLA association with dementias and at least one autoimmune disease (**Figure 5A-E**).

96

### 97 **Pathway analyses**

98 To identify pathways the 126 biomarkers are involved in, we performed analyses based on KEGG,  
99 ClueGO, and ConsensusPathDB databases. The findings provided further support for the  
100 autoimmune component in dementias. KEGG and ClueGO analyses showed that the identified  
101 biomarkers increased MHC-II-mediated antigen presentation in several processes, HLA-DR  
102 expression across all hematopoietic cell lines, neuronal adhesion molecule CNTN2, and PD-L1 in  
103 T-cell-antigen interactions that reduces self-tolerance. The biomarkers also decreased barrier  
104 protecting IL-17F, self-tolerance increasing PDCD1 in T-cell-antigen interactions, and antiviral  
105 complement factor B and IFNAR1 (**SFigures 4A-H and 5**). ConsensusPathDB analyses showed  
106 that all of the 42 plasma proteins included in the 126 biomarkers had physical interactions with or  
107 were in a biological pathway within zero to two molecule distance from amyloid precursor protein,  
108 tau protein, or  $\alpha$ -synuclein (**SFigure 6A-R**).

109

### 110 **Inverse probability-weighted analyses**

111 To evaluate the autoimmune hypothesis in relation to modifiability and drug repurposing, we used  
112 inverse probability-weighted (IPW) analyses in FinnGen and studied whether commonly used anti-  
113 inflammatory and immunosuppressive medications are likely to reduce the risk of dementias (**Table**  
114 **1**). We validated the IPW protocol with a positive control, by replicating the randomized controlled  
115 trial (RCT) effect between statin medication and myocardial infarction and used anti-inflammatory  
116 medications as negative control.<sup>14-17</sup> Supporting the autoimmune hypothesis, risk of dementia-  
117 causing diseases was reduced with methotrexate and TNF- $\alpha$  inhibitors. Methotrexate appeared to  
118 decrease risk only in those with above-average MR-based autoimmune PRS (50% cut-off). To  
119 identify rare medications not detectable in FinnGen with sufficient power, we additionally searched  
120 the OpenTargets database. This search identified 64 drugs that target 18 of the 126 proteins,  
121 suggesting that these may have potential for repurposing to treatment of dementias (**SFile 2**).

122

### 123 **Discussion**

124

125 Using triangulation across Mendelian randomization, plasma proteomics, polygenic risk scores,  
126 HLA type, pathway, and IPW analyses, we identified causal support for 126 risk factors and  
127 potential drug targets for dementia-causing diseases. Of these 118 were novel MR associations.  
128 Most of the identified risk factors and targets were outcome specific, and included inflammatory,  
129 self-tolerance, and/or BBB tight junction related biomarkers. A phenome-wide analysis of PRS  
130 from SNPs associated with the identified risk factors showed that Alzheimer's disease share genetic  
131 background with autoimmune diseases, such as rheumatoid arthritis and type 1 diabetes. The

132 autoimmune hypothesis was also supported by HLA analyses showing 21 HLA-type associations  
133 common to dementias and autoimmune diseases. Pathway analyses linked the 126 biomarkers to  
134 autoimmunity via antigen presentation and reduced self-tolerance and showed that all 42 plasma  
135 proteins of the 126 biomarkers are closely related to  $\alpha$ -synuclein, amyloid precursor, and tau protein  
136 pathways that characterize Alzheimer's and Parkinson's diseases and dementia with Levy bodies.  
137 The autoimmune hypothesis was further supported by IPW analyses mimicking randomized  
138 controlled drug trial in observational data. They suggested anti-inflammatory medication use may  
139 potentially reduce the risk of these illnesses.

140  
141 Several lines of earlier and current evidence support the hypothesis that diseases causing dementia  
142 have an autoimmune component (**Figure 2**). Epidemiological studies have shown higher rates of  
143 cognitive impairment, Alzheimer's diseases, Parkinson's disease, vascular, and frontotemporal  
144 dementia in rheumatic disease patients.<sup>18-22</sup> Diabetes is a recognized risk factor for Alzheimer's  
145 disease<sup>23</sup> and individuals with type 1 diabetes have higher rate of cognitive decline, Alzheimer's  
146 disease, and vascular dementia.<sup>24,25</sup> Thyroiditis, which often has an autoimmune origin, increases  
147 risk of dementias.<sup>10,26</sup> In agreement with these findings, we showed that MR-based Alzheimer's  
148 disease PRS increased risk of all these autoimmune diseases. In addition, the PRS was associated  
149 with reduced risk of cancers, which is a well-described beneficial side effect of reduced self-  
150 tolerance commonly harnessed in cancers medications.<sup>27</sup>

151  
152 Furthermore, risk factors, course of disease, and clinical picture in dementias and autoimmune  
153 diseases have several similarities. Alzheimer's and autoimmune diseases are more common in  
154 women<sup>9,28,29</sup> and the diseases share inflammatory risk factors such as smoking and obesity.<sup>9,23,30,31</sup>  
155 Infections increase risk for autoimmune diseases,<sup>32</sup> rate of cognitive decline,<sup>1</sup> and dementias even  
156 20 years before the diagnosis,<sup>7</sup> and can acutely trigger rheumatoid arthritis, type 1 diabetes and the  
157 formation of autoantibodies against CNS that lead to tissue degeneration.<sup>8,9,11</sup> Interestingly, many  
158 inflammation-related biomarkers in our analyses influenced pathways closely related to amyloid  
159 precursor protein, tau protein, or  $\alpha$ -synuclein suggesting that they may contribute to proteinopathies  
160 that characterize of Alzheimer's and Parkinson's disease and dementia with Levy bodies. This  
161 process has some similarities with AA form of amyloidosis in rheumatic arthritis in which  
162 uncontrolled inflammation accumulates amyloid to a range of tissues<sup>33</sup> and with islet amyloidosis in  
163 diabetes that leads to tissue degeneration.<sup>34</sup> Two MR studies suggested inflammatory risk factor  
164 may not be causally linked to dementias.<sup>35,36</sup> However, those studies did not focus on processes that  
165 control self-tolerance and they may have used inflammatory markers that are only responses to  
166 these processes and thus prone to produce null finding or reverse causation in MR analyses.

### 167 168 **Common cellular mechanisms between autoimmune disease and dementias**

169 At cellular level, loss of central tolerance in central immune organs and subsequent escape of  
170 autoreactive B- and T-cells to periphery<sup>37,38</sup> are thought to predispose to autoimmune diseases  
171 together with certain HLA alleles.<sup>9,39,40</sup> Conversion to disease may occur after complex interplay  
172 between inflammation, infections, and tissue damage, with subsequent failure of peripheral self-  
173 tolerance mechanisms such as ignorance, anergy, suppression, inhibition, and antigen  
174 presentation.<sup>37,38</sup> Our results link all of these mechanism to the development of dementias.

175

176 BBB normally controls tightly the access of toxins, pathogens, and peripheral molecules and cells to  
177 CNS.<sup>4</sup> This keeps peripheral lymphocytes “ignorant” of CNS structures and prevents activation of  
178 autoreactive cells against CNS.<sup>38</sup> However, chronic antigen exposure and activation of innate and  
179 adaptive immune systems impair BBB by releasing pro-inflammatory cytokines, prostaglandins,  
180 and histamine leading to endothelial damage and upregulation of adhesion molecules.<sup>4,41</sup> This  
181 exposes CNS to autoreactive peripheral lymphocytes that lose their ignorance.<sup>38</sup> The prolonged  
182 inflammation also leads to reduced anergy, which allows more potentially self-reactive T-  
183 lymphocytes to proliferate.<sup>38</sup>

184  
185 Our MR analyses support these processes. We showed that higher plasma levels of the integral part  
186 of BBB, the tight junction component (TJP1<sup>42</sup>), and proteins degrading it (AIMP1<sup>43</sup> and BIN1<sup>44</sup>),  
187 increased the risk of dementias. Moreover, pro-inflammatory C1Q, C1R, CD20, CD11, CDHR5,  
188 GPNMB, and IL1 $\beta$ <sup>45-49</sup> elevated risk of dementias, whereas anti-inflammatory C4B, IL27, IL37,  
189 PTP1B, and SIGIRR<sup>50-54</sup> and barrier protecting IL-17F<sup>55</sup> reduced the risk. In suppression and  
190 inhibition, regulatory T-cells suppress, or molecules on B- and T-cells inhibit activation of  
191 lymphocytes at peripheral checkpoints.<sup>38</sup> Our MR analyses identified several checkpoint regulators  
192 including BAFFR, C1R, C1Q, CD11, CD19, CD20, CD22, CD33, CD40, CX3CR1, LTBR, PD-1,  
193 and PDL-1<sup>37,48,56-64</sup> as potential causal risk factors for poor cognitive performance and dementias,  
194 uncovering the importance of checkpoint control and autoreactive lymphocytes in dementias.

195  
196 HLA analyses were also consistent with the autoimmunity hypothesis. After the increase in BBB  
197 permeability, peripherally driven neuroinflammation activates central neuroinflammatory responses  
198 in astrocytes and microglia.<sup>1,4</sup> The chronic neuroinflammation, pathogens, and tissue damage  
199 initiate antigen presentation in HLA receptors on antigen-presenting cells in CNS that can activate  
200 the autoreactive B- and T-cells and initiate self-sustaining autoimmunity<sup>11,40</sup> against CNS structures.  
201 Supporting this we identified 21 shared HLA-types between autoimmune diseases and dementias.  
202 Similarly, MR and pathway analyses supported causal status of HLA-DR and HLA-DQ cell types  
203 in dementias.

204  
205 The autoreactive cells can be activated via bystander activation, or HLA-mediated molecular  
206 mimicry and epitope spreading.<sup>8-10,38</sup> In bystander activation, sustained or excessive immune  
207 response can bypass normal T-cell antigen presentation to B-cells and activate autoreactive B-cell  
208 to plasma cell that produces autoantibodies. In molecular mimicry, autoreactive T- and B-cells first  
209 target foreign antigens, and then cross-react with similar self-antigens expressed by host cells. In  
210 epitope spreading, cryptic epitopes (parts of dying cells, and intrinsic or foreign DNA or RNA)  
211 normally invisible to immune system become visible after tissue damage, which activates  
212 autoreactive B- and T cells on these epitopes.

213  
214 Our results also provide support for these mechanisms. In MR analyses, we observed that higher  
215 levels of naïve and memory CD20 B-cells, the main drug target for B-cell induced autoimmune  
216 diseases,<sup>65</sup> increases risk for Alzheimer’s diseases. Similarly, higher levels of CD19, a co-receptor  
217 on B-cells that can lead to autoimmunity when hyperactivated,<sup>66</sup> increased Parkinson’s diseases  
218 risk. We also observed that higher levels of IgG against Epstein-Barr virus’ nuclear antigen, a  
219 marker of active infection that can mimic CNS structures,<sup>67,68</sup> elevated Alzheimer’s diseases risk. In



220 addition, IFIT2 that intercepts foreign RNA and protects against central viral infections,<sup>69</sup> reduced  
221 the risk of all dementia causing diseases except Parkinson's diseases. Moreover, the pathway  
222 analyses suggested that many proteins (COPS6, SOCS3, PSMB5, TOLLIP, TRIM21, PRPF40A,  
223 NOC4L, RPS6, IK, KRR1, and MTO1)<sup>70-80</sup> involved in intracellular pathways from DNA, RNA,  
224 and protein processing to antigen presentation may be linked with amyloid  $\beta$ , tau protein, and  $\alpha$ -  
225 synuclein.

226  
227 The identified 8 proteins with SNPs located near *APOE* gene were associated with increased BBB  
228 permeability, inflammation, neurotoxicity, and lipid transport disturbances,<sup>42,56,69,81-84</sup> which are all  
229 processes linked to *APOE* in Alzheimer's disease.<sup>85</sup> Our results suggest that the 8 proteins may be  
230 linked to the effects of *APOE*. Another novel result was that higher levels of CD33, one of the top  
231 GWAS hits for Alzheimer's diseases<sup>86</sup> and target receptor on microglia for an ongoing trial  
232 (NCT03822208) including mild to moderate Alzheimer's diseases patients, increased the risk of  
233 disease even when expressed on peripheral leukocytes.

### 234 235 **Anti-inflammatory medications and dementias**

236 Our IPW analyses on use of anti-inflammatory medications, including records of filled drug  
237 prescriptions in initially dementia-free individuals at baseline followed up to 20 years supported the  
238 modifiability of dysfunctional autoimmune processes. We replicated protective associations  
239 between TNF- $\alpha$  inhibitors,<sup>87</sup> methotrexate,<sup>88</sup> and Alzheimer's disease. As novel findings we showed  
240 that methotrexate may be protective only for Alzheimer's and Parkinson's disease among those  
241 with high MR-based PRS. These findings are plausible on a cellular level for BBB degradation and  
242 neuroinflammation. TNF- $\alpha$  is a gatekeeper of inflammatory responses and endothelial  
243 permeability.<sup>89</sup> Methotrexate, in turn, modulates a range of inflammatory and immune responses in  
244 nearly every cell types forming the foundations for treatment of rheumatoid arthritis.<sup>9</sup> NSAIDs and  
245 antihistamines appeared to decrease risk for all dementias but the validation using a negative control  
246 outcome (coronary heart disease) suggested that the IPW model for these medications was  
247 insufficient to replicate trial design.

248  
249 Randomized controlled trials of TNF- $\alpha$  inhibitors in Alzheimer's disease patients have not shown  
250 benefits in 1 to 2 year follow-up.<sup>90,91</sup> However, in autoimmune diseases, early initiation of anti-  
251 inflammatory medication is of paramount importance suggesting that the trials of medication for  
252 people with established dementia may be too late.<sup>9</sup>

### 253 254 **Strengths and limitations**

255 Our triangulation approach has several strengths. By using a broad set of immune system and BBB  
256 biomarkers we were able to study these systems comprehensively without restrictions to specific  
257 predefined hypotheses. Our findings are based on MR, a promising approach to examine causality,<sup>12</sup>  
258 and on analyses using plasma proteomics, PRS, HLA, pathway, and IPW analyses in two  
259 independent cohorts and a range of databases. Plasma protein analyses allowed us to adjust effect  
260 estimates for *APOE* which was not possible in Mendelian randomization analyses for some  
261 proteins. PRS and HLA analyses used data from the FinnGen study with a sample size of 340,000  
262 providing sufficient statistical power for the identification of shared novel risk alleles between  
263 dementias and autoimmune disease. We used ConsensusPathDB, which is one of the most

264 comprehensive collection of databases on molecular pathways and interactions.<sup>92</sup> The medication  
265 analyses used IPW survival analysis that is suggested to provide more reliable causal estimates than  
266 traditional survival analyses of observational data.<sup>93</sup>

267

268 Our study has also several limitations. Although we explored over 40,000 biomarkers related to the  
269 immune system and BBB, we may have missed some biomarkers due to limitations in search  
270 protocol or lack of SNPs. Our plasma protein analyses were limited by lack of data on dementia  
271 subtypes. The PRS and PheWAS analyses were done with samples with European ancestry and may  
272 not apply to non-European ancestries. Due to limited number of SNPs included in PRS, we may  
273 have missed important immune system and BBB related associations in our phenome-wide  
274 analyses. Nonetheless, the Alzheimer's MR-based PRS associated strongly with all types of  
275 dementia (except Parkinson's disease) and a range of outcomes related to type 1 diabetes and  
276 rheumatic diseases suggesting that at least these findings are robust. The IPW analyses on  
277 medications may include some bias due to a limited number of covariates for simulation of  
278 randomized control trial. However, major bias is unlikely for the main findings since the analysis  
279 protocol was validated by a positive- and negative-control analyses.

280

281

## 282 **Conclusions**

283

284 In summary, this study provides novel insights into autoimmunity, BBB, and inflammatory  
285 dysfunctions that may contribute to the development of dementias. As the inflammatory  
286 components are potentially modifiable with anti-inflammatory medications, the present results also  
287 raise hypotheses on several novel drug targets for dementia-causing diseases which need to be  
288 validated in future experimental studies. Randomized controlled trials on early initiation of these  
289 medications for high-risk individuals are warranted while antigen-specific prevention strategies may  
290 offer new avenues in search of treatment for dementias.

291

292

## 293 **Methods**

294

### 295 **Mendelian randomization**

296 The SNPs for biomarkers and outcomes were searched from MR-base database.<sup>94</sup> Immune system  
297 and BBB search terms were identified using identifiers of cell types, receptors, proteins,  
298 metabolites, and genes. The identifiers were searched from several publications<sup>3,4,6,23,36,38,40,95,96</sup> and  
299 from Uniprot<sup>97</sup> with search terms “immune” and “blood brain barrier”. Outcomes included all  
300 cohorts with following diseases: all types of Alzheimer's disease, Parkinson's disease, vascular  
301 dementia, frontotemporal dementia, dementia in general, and progression of dementia. (**SMethods**).  
302 Poor cognitive performance was chosen as an intermediate outcome. Two sample MR was used to  
303 analyse associations between biomarkers and outcomes.<sup>12</sup> First analyses estimated effects with  
304 Wald ratio or inverse variance-weighted analyses.<sup>94</sup> For biomarker-outcome pairs that passed FDR  
305 of 5% and shared over two common SNPs we performed sensitivity analyses with weighted

306 median, simple mode, MR Egger, and backward Mendelian randomization<sup>12</sup> with TwoSampleMR  
307 and MRInstruments R packages.

308

309 To assess off-target effects of the observed causal biomarkers, we performed a phenome-wide MR  
310 analysis for each biomarker, using GWAS summary statistics for 210 UK Biobank endpoints  
311 conducted by Neale lab and with recognized dementia risk factors.<sup>23,98</sup>

312

313

314

### 315 **Plasma protein analyses**

316 Plasma protein measurements in Whitehall II study were available for 6,235 individuals of whom  
317 310 developed dementia and the methods have been describe before (**SMethods**).<sup>6,99,100</sup> In brief, the  
318 plasma proteins were measured using the SomaScan version 4.0 and 4.1 assays.<sup>6,101,102</sup> The assays  
319 were validated against external reference population and protein-specific conversion coefficients  
320 were used to balance the technical differences between versions 4.0 and 4.1. Using DNA extracted  
321 from whole blood, a standard PCR assay determined *APOE* genotype using the salting out  
322 method.<sup>103,104</sup> In analyses, proteins were transformed to a normal distribution by inverse rank-based  
323 normal transformation. The analyses used plasma samples measured in 1995/1997 and the follow-  
324 up ended at onset of dementia, death, or 1<sup>st</sup> of October 2019, which ever occurred first. Cox  
325 regression models adjusted for age, sex, and *APOE* estimated associations between the proteins and  
326 dementia.<sup>105</sup> The proportionality assumption in all Cox models was assessed with Schoenfeld  
327 residuals and with log-log plots.<sup>105</sup> We used statistical software R (3.6.0 and 4.1.0) for these  
328 analyses.

329

### 330 **Polygenic risk score and IPW analyses**

331 FinnGen Data Freeze 8 contains 339,233 individuals, and is a collection of prospective  
332 epidemiological and disease-based cohorts, and hospital biobank samples and links genotypes by  
333 the unique national personal identification numbers to nationwide health registries, including the  
334 national hospital discharge (available from 1968), death (1969–), cancer (1953–) and medication  
335 reimbursement (1964–) and purchase (1995–) registries. Genotyping and imputation is described in  
336 **SMethods**.

337

338 PRS was constructed from SNPs that were associated with the 126 MR identified causal biomarkers  
339 for dementias. The SNPs were LD-pruned with clumping cut-off  $R^2 = 0.01$  in 500kb window with  
340 R package TwoSampleMR. The available SNPs were searched from FinnGen genotypes and the  
341 final scores were generated with PLINK v2.00aLM3 by calculating the SNP-biomarker beta  
342 weighted sum of risk alleles for each SNP. The PRS was scaled to zero mean and unit variance, and  
343 we analysed its phenome-wide associations across 2401 disease endpoints. The association between  
344 PRS and endpoints were studied with logistic regression, adjusting for birth year, sex, and ten first  
345 principal components of ancestry.

346

347 The IPW analyses<sup>93</sup> were done in FinnGen and included participants aged over 45 without any  
348 dementia-causing disease at baseline (N = 90,512). ATC codes for anti-inflammatory medication  
349 use were obtained from linkage to national medication purchase registry (data starts from 1995) and

350 in each analyses we included only new medication users to simulate trial design.<sup>106</sup> A model  
351 including a range of baseline and time-varying variables and informative censoring estimated the  
352 weights (**SMethods**). The analyses used time-varying Cox models and assumptions were assessed  
353 similar to plasma proteins. The follow-up started in 1997 and ended at onset of dementia, death, or  
354 31<sup>st</sup> of December 2019, which ever occurred first. We used R (4.1.2) and ipw package for these  
355 analyses.

### 357 **HLA analyses**

358 The analyses were done using HLA alleles, imputed with high accuracy using a Finnish-specific  
359 reference panel, which has been previously described in detail.<sup>107</sup> After filtering based on a HLA  
360 carrier frequency of  $\geq 0.01$  and posterior probability of  $\geq 0.6$ , we assessed the association between  
361 HLA alleles and dementias and autoimmune diseases using logistic regression adjusted for birth  
362 year, sex, and ten first principal components of ancestry.

### 364 **Pathway analyses**

365 KEGG pathway analysis was done with Generally Applicable Gene-set Enrichment (GAGE),<sup>108</sup>  
366 using MR betas and p-values as input for expression ratios. GO term enrichment analyses were  
367 done with ClueGO version 2.5.8<sup>109</sup> in Cytoscape version 3.7.2<sup>110</sup> (**SMethods**). The hypergeometric  
368 test used all the 76 plasma proteins or surface receptors of the 126 biomarkers as input and all  
369 immune system and BBB related proteins from Uniprot<sup>97</sup> as background, with correction for 5%  
370 FDR. The shortest interaction path analyses were done with ConsensusPathDB,<sup>92</sup> a web based  
371 analysis tool containing several biomedical databases.

### 373 **Open Targets analyses**

374 Medications that change the levels of the 126 biomarkers were searched from Open Targets  
375 database using Uniprot protein and Entrez gene symbols.

376  
377  
378  
379  
380  
381  
382  
383  
384  
385  
386  
387  
388  
389  
390  
391  
392  
393

394 **Ethics statement**

395 In the Whitehall II study, research ethics approvals were renewed at each wave; the most recent  
396 approval was obtained from the University College London Hospital Committee on the Ethics of  
397 Human Research (reference number 85/0938). Written, informed consent from participants was  
398 obtained at each contact.

399  
400 Patients and control subjects in FinnGen provided informed consent for biobank research, based on  
401 the Finnish Biobank Act. Alternatively, separate research cohorts, collected prior the Finnish  
402 Biobank Act came into effect (in September 2013) and start of FinnGen (August 2017), were  
403 collected based on study-specific consents and later transferred to the Finnish biobanks after  
404 approval by Fimea (Finnish Medicines Agency), the National Supervisory Authority for Welfare  
405 and Health. Recruitment protocols followed the biobank protocols approved by Fimea. The  
406 Coordinating Ethics Committee of the Hospital District of Helsinki and Uusimaa (HUS) statement  
407 number for the FinnGen study is Nr HUS/990/2017.

408  
409 The FinnGen study is approved by Finnish Institute for Health and Welfare (permit numbers:  
410 THL/2031/6.02.00/2017, THL/1101/5.05.00/2017, THL/341/6.02.00/2018,  
411 THL/2222/6.02.00/2018, THL/283/6.02.00/2019, THL/1721/5.05.00/2019 and  
412 THL/1524/5.05.00/2020), Digital and population data service agency (permit numbers:  
413 VRK43431/2017-3, VRK/6909/2018-3, VRK/4415/2019-3), the Social Insurance Institution  
414 (permit numbers: KELA 58/522/2017, KELA 131/522/2018, KELA 70/522/2019, KELA  
415 98/522/2019, KELA 134/522/2019, KELA 138/522/2019, KELA 2/522/2020, KELA 16/522/2020),  
416 Findata permit numbers THL/2364/14.02/2020,  
417 THL/4055/14.06.00/2020, THL/3433/14.06.00/2020, THL/4432/14.06/2020,  
418 THL/5189/14.06/2020, THL/5894/14.06.00/2020, THL/6619/14.06.00/2020,  
419 THL/209/14.06.00/2021, THL/688/14.06.00/2021, THL/1284/14.06.00/2021,  
420 THL/1965/14.06.00/2021, THL/5546/14.02.00/2020, THL/2658/14.06.00/2021,  
421 THL/4235/14.06.00/2021 and Statistics Finland (permit numbers: TK-53-1041-17 and  
422 TK/143/07.03.00/2020 (earlier TK-53-90-20) TK/1735/07.03.00/2021).

423  
424 The Biobank Access Decisions for FinnGen samples and data utilized in FinnGen Data Freeze 8  
425 include: THL Biobank BB2017\_55, BB2017\_111, BB2018\_19, BB\_2018\_34, BB\_2018\_67,  
426 BB2018\_71, BB2019\_7, BB2019\_8, BB2019\_26, BB2020\_1, Finnish Red Cross Blood Service  
427 Biobank 7.12.2017, Helsinki Biobank HUS/359/2017, Auria Biobank AB17-5154 and amendment  
428 #1 (August 17 2020), AB20-5926 and amendment #1 (April 23 2020), Biobank Borealis of  
429 Northern Finland\_2017\_1013, Biobank of Eastern Finland 1186/2018 and amendment 22 § /2020,  
430 Finnish Clinical Biobank Tampere MH0004 and amendments (21.02.2020 & 06.10.2020), Central  
431 Finland Biobank 1-2017, and Terveystalo Biobank STB 2018001.

432  
433 **Acknowledgments and Funding Sources**

434 We want to acknowledge the participants and investigators of FinnGen study. The FinnGen project  
435 is funded by two grants from Business Finland (HUS 4685/31/2016 and UH 4386/31/2016) and the  
436 following industry partners: AbbVie Inc., AstraZeneca UK Ltd, Biogen MA Inc., Bristol Myers  
437 Squibb (and Celgene Corporation & Celgene International II Sàrl), Genentech Inc., Merck Sharp &

438 Dohme Corp, Pfizer Inc., GlaxoSmithKline Intellectual Property Development Ltd., Sanofi US  
439 Services Inc., Maze Therapeutics Inc., Janssen Biotech Inc, Novartis AG, and Boehringer  
440 Ingelheim. Following biobanks are acknowledged for delivering biobank samples to FinnGen:  
441 Auria Biobank ([www.auria.fi/biopankki](http://www.auria.fi/biopankki)), THL Biobank ([www.thl.fi/biobank](http://www.thl.fi/biobank)), Helsinki Biobank  
442 ([www.helsinginbiopankki.fi](http://www.helsinginbiopankki.fi)), Biobank Borealis of Northern Finland  
443 (<https://www.ppshep.fi/Tutkimus-ja-opetus/Biopankki/Pages/Biobank-Borealis-briefly-in->  
444 [English.aspx](https://www.ppshep.fi/Tutkimus-ja-opetus/Biopankki/Pages/Biobank-Borealis-briefly-in-English.aspx)), Finnish Clinical Biobank Tampere ([www.tays.fi/en-](http://www.tays.fi/en-US/Research_and_development/Finnish_Clinical_Biobank_Tampere)  
445 [US/Research\\_and\\_development/Finnish\\_Clinical\\_Biobank\\_Tampere](http://www.tays.fi/en-US/Research_and_development/Finnish_Clinical_Biobank_Tampere)), Biobank of Eastern Finland  
446 ([www.ita-suomenbiopankki.fi/en](http://www.ita-suomenbiopankki.fi/en)), Central Finland Biobank ([www.ksshp.fi/fi-](http://www.ksshp.fi/fi-FI/Potilaalle/Biopankki)  
447 [FI/Potilaalle/Biopankki](http://www.ksshp.fi/fi-FI/Potilaalle/Biopankki)), Finnish Red Cross Blood Service Biobank  
448 ([www.veripalvelu.fi/verenluovutus/biopankkitoiminta](http://www.veripalvelu.fi/verenluovutus/biopankkitoiminta)) and Terveystalo Biobank  
449 ([www.terveystalo.com/fi/Yritystietoa/Terveystalo-Biopankki/Biopankki/](http://www.terveystalo.com/fi/Yritystietoa/Terveystalo-Biopankki/Biopankki/)). All Finnish Biobanks are  
450 members of BBMRI.fi infrastructure ([www.bbmri.fi](http://www.bbmri.fi)). Finnish Biobank Cooperative -FINBB  
451 (<https://finbb.fi/>) is the coordinator of BBMRI-ERIC operations in Finland. The Finnish biobank  
452 data can be accessed through the Fingenious® services (<https://site.fingenious.fi/en/>) managed by  
453 FINBB.

454  
455 The study was supported by the Wellcome Trust (221854/Z/20/Z), the UK Medical Research  
456 Council (S011676, K013351, R024227), the National Institute on Aging (National Institutes of  
457 Health; R01AG056477 and RF1AG062553), the British Heart Foundation (RG/16/11/32334), the  
458 Academy of Finland (311492), NordForsk (75021), and SomaLogic, Inc. JVL was supported by  
459 Academy of Finland (339568). NM was supported by the Academy of Finland (331671). PNS was  
460 supported by the Emil Aaltonen Foundation. MK was supported by the Wellcome Trust  
461 (221854/Z/20/Z), UK Medical Research Council (MR/S011676, MR/R024227), US National  
462 Institute on Aging (R01AG062553, R01AG056477), Academy of Finland (311492), Helsinki  
463 Institute of Life Science (H970), and the Finnish Work Environment Fund (190424). SR was  
464 funded by Academy of Finland (285380 and 312062), Sigrid Jusélius Foundation and University of  
465 Helsinki HiLIFE Fellow grants 2017-2020.

466  
467 FinnGen consortium authors are listed in FinnGen Banner Authors file.

468  
469

#### 470 **Author Contributions**

471 JVL, NM, SR, and MK generated the hypothesis and designed the study. JVL wrote the first draft  
472 of the report, did the primary analyses, with support from NM, and performed literature searches.  
473 All authors interpreted the data and critically commented and reviewed the report. JVL and MK had  
474 full access to pseudonymised data from the Whitehall II. JVL, NM, and SR had full access to  
475 pseudonymised data from the FinnGen study.

476

#### 477 **Competing interests**

478 In Whitehall II study part of the proteins were measured as academic–industry partnership project  
479 between UCL and SomaLogic, Inc. which provided expertise in plasma proteins and funded 2240  
480 SOMAscan assays. PNS reports a grant from the Emil Aaltonen foundation, during the conduct of  
481 the study. MK reports grants from Wellcome Trust, UK Medical Research Council, US National

482 Institute on Aging, Academy of Finland, Helsinki Institute of Life Science, and the Finnish Work  
483 Environment Fund, during the conduct of the study.

484

485 **Data sharing**

486 Data, protocols, and other metadata of the Whitehall II and FinnGen studies are available according  
487 to the data sharing policies of these studies. Pre-existing data access policy for Whitehall II specify  
488 that research data requests can be submitted to each steering committee; these will be promptly  
489 reviewed for confidentiality or intellectual property restrictions and will not unreasonably be  
490 refused. Detailed information on data sharing can be found here:

491 [https://www.ucl.ac.uk/epidemiology-health-care/research/epidemiology-and-public-](https://www.ucl.ac.uk/epidemiology-health-care/research/epidemiology-and-public-health/research/whitehall-ii/data-sharing)

492 [health/research/whitehall-ii/data-sharing](https://www.ucl.ac.uk/epidemiology-health-care/research/epidemiology-and-public-health/research/whitehall-ii/data-sharing) Individual-level patient or protein data may further be  
493 restricted by consent, confidentiality, or privacy laws/considerations. The FinnGen data may be  
494 accessed through Finnish Biobanks' FinBB portal ([www.finbb.fi](http://www.finbb.fi)).

495

496

497

498

499

500

501

502

503

504

505

506

507

508

509

510

511

512

513

514

515

516

517

518

519

520

521

522

523

524

525

526 **References**

527

528

- 529 1. Bettcher, B.M., Tansey, M.G., Dorothée, G. & Heneka, M.T. Peripheral and central immune  
530 system crosstalk in Alzheimer disease - a research prospectus. *Nat Rev Neurol* **17**, 689-701  
531 (2021).
- 532 2. Kinney, J.W., *et al.* Inflammation as a central mechanism in Alzheimer's disease.  
533 *Alzheimers Dement (N Y)* **4**, 575-590 (2018).
- 534 3. Tan, E.K., *et al.* Parkinson disease and the immune system - associations, mechanisms and  
535 therapeutics. *Nat Rev Neurol* **16**, 303-318 (2020).
- 536 4. Sweeney, M.D., Zhao, Z., Montagne, A., Nelson, A.R. & Zlokovic, B.V. Blood-Brain  
537 Barrier: From Physiology to Disease and Back. *Physiological Reviews* **99**, 21-78 (2019).
- 538 5. Franceschi, C., Garagnani, P., Parini, P., Giuliani, C. & Santoro, A. Inflammaging: a new  
539 immune-metabolic viewpoint for age-related diseases. *Nat Rev Endocrinol* **14**, 576-590  
540 (2018).
- 541 6. Lindbohm, J.V., *et al.* Plasma proteins, cognitive decline, and 20-year risk of dementia in  
542 the Whitehall II and Atherosclerosis Risk in Communities studies. *Alzheimer's & dementia :  
543 the journal of the Alzheimer's Association* (2021).
- 544 7. Sipilä, P.N., *et al.* Hospital-treated infectious diseases and the risk of dementia: a large,  
545 multicohort, observational study with a replication cohort. *Lancet Infect Dis* **21**, 1557-1567  
546 (2021).
- 547 8. Op de Beeck, A. & Eizirik, D.L. Viral infections in type 1 diabetes mellitus--why the  $\beta$   
548 cells? *Nat Rev Endocrinol* **12**, 263-273 (2016).
- 549 9. Smolen, J.S., *et al.* Rheumatoid arthritis. *Nature Reviews Disease Primers* **4**, 18001 (2018).
- 550 10. Stassi, G. & De Maria, R. Autoimmune thyroid disease: new models of cell death in  
551 autoimmunity. *Nat Rev Immunol* **2**, 195-204 (2002).
- 552 11. Prüss, H. Autoantibodies in neurological disease. *Nat Rev Immunol* **21**, 798-813 (2021).
- 553 12. Holmes, M.V., Richardson, T.G., Ference, B.A., Davies, N.M. & Davey Smith, G.  
554 Integrating genomics with biomarkers and therapeutic targets to invigorate cardiovascular  
555 drug development. *Nat Rev Cardiol* **18**, 435-453 (2021).
- 556 13. Munafo, M.R. & Davey Smith, G. Robust research needs many lines of evidence. *Nature*  
557 **553**, 399-401 (2018).
- 558 14. Law, M.R., Wald, N.J. & Rudnicka, A.R. Quantifying effect of statins on low density  
559 lipoprotein cholesterol, ischaemic heart disease, and stroke: systematic review and meta-  
560 analysis. *Bmj* **326**, 1423 (2003).
- 561 15. Bally, M., *et al.* Risk of acute myocardial infarction with NSAIDs in real world use:  
562 bayesian meta-analysis of individual patient data. *Bmj* **357**, j1909 (2017).
- 563 16. Thanigaimani, S., Phie, J., Krishna, S.M., Moxon, J. & Golledge, J. Effect of disease  
564 modifying anti-rheumatic drugs on major cardiovascular events: a meta-analysis of  
565 randomized controlled trials. *Sci Rep* **11**, 6627 (2021).
- 566 17. Ridker, P.M., *et al.* Low-Dose Methotrexate for the Prevention of Atherosclerotic Events.  
567 *New England Journal of Medicine* **380**, 752-762 (2018).
- 568 18. Broce, I., *et al.* Immune-related genetic enrichment in frontotemporal dementia: An analysis  
569 of genome-wide association studies. *PLoS Med* **15**, e1002487 (2018).
- 570 19. Chou, R.C., Kane, M., Ghimire, S., Gautam, S. & Gui, J. Treatment for Rheumatoid  
571 Arthritis and Risk of Alzheimer's Disease: A Nested Case-Control Analysis. *CNS Drugs* **30**,  
572 1111-1120 (2016).
- 573 20. Wallin, K., *et al.* Midlife rheumatoid arthritis increases the risk of cognitive impairment two  
574 decades later: a population-based study. *J Alzheimers Dis* **31**, 669-676 (2012).



- 575 21. Zhou, M., Xu, R., Kaelber, D.C. & Gurney, M.E. Tumor Necrosis Factor (TNF) blocking  
576 agents are associated with lower risk for Alzheimer's disease in patients with rheumatoid  
577 arthritis and psoriasis. *PLoS One* **15**, e0229819 (2020).
- 578 22. Li, X., Sundquist, J. & Sundquist, K. Subsequent risks of Parkinson disease in patients with  
579 autoimmune and related disorders: a nationwide epidemiological study from Sweden.  
580 *Neurodegener Dis* **10**, 277-284 (2012).
- 581 23. Livingston, G., *et al.* Dementia prevention, intervention, and care: 2020 report of the Lancet  
582 Commission. *Lancet (London, England)* **396**, 413-446 (2020).
- 583 24. Jacobson, A.M., *et al.* Cognitive performance declines in older adults with type 1 diabetes:  
584 results from 32 years of follow-up in the DCCT and EDIC Study. *Lancet Diabetes*  
585 *Endocrinol* **9**, 436-445 (2021).
- 586 25. Lacy, M.E., *et al.* Long-term Glycemic Control and Dementia Risk in Type 1 Diabetes.  
587 *Diabetes Care* **41**, 2339-2345 (2018).
- 588 26. Sipilä, P.N., *et al.* Long-term risk of dementia following hospitalization due to physical  
589 diseases: A multicohort study. *Alzheimer's & dementia : the journal of the Alzheimer's*  
590 *Association* **16**, 1686-1695 (2020).
- 591 27. Leach, D.R., Krummel, M.F. & Allison, J.P. Enhancement of antitumor immunity by  
592 CTLA-4 blockade. *Science* **271**, 1734-1736 (1996).
- 593 28. Krischer, J.P., *et al.* The Influence of Type 1 Diabetes Genetic Susceptibility Regions, Age,  
594 Sex, and Family History on the Progression From Multiple Autoantibodies to Type 1  
595 Diabetes: A TEDDY Study Report. *Diabetes* **66**, 3122-3129 (2017).
- 596 29. Gleicher, N. & Barad, D.H. Gender as risk factor for autoimmune diseases. *J Autoimmun* **28**,  
597 1-6 (2007).
- 598 30. Corbin, K.D., *et al.* Obesity in Type 1 Diabetes: Pathophysiology, Clinical Impact, and  
599 Mechanisms. *Endocr Rev* **39**, 629-663 (2018).
- 600 31. Rasouli, B., *et al.* Smoking and the Risk of LADA: Results From a Swedish Population-  
601 Based Case-Control Study. *Diabetes Care* **39**, 794-800 (2016).
- 602 32. Nielsen, P.R., Kragstrup, T.W., Deleuran, B.W. & Benros, M.E. Infections as risk factor for  
603 autoimmune diseases - A nationwide study. *J Autoimmun* **74**, 176-181 (2016).
- 604 33. Perfetto, F., *et al.* Systemic amyloidosis: a challenge for the rheumatologist. *Nature Reviews*  
605 *Rheumatology* **6**, 417-429 (2010).
- 606 34. Rojas, J., *et al.* Pancreatic Beta Cell Death: Novel Potential Mechanisms in Diabetes  
607 Therapy. *J Diabetes Res* **2018**, 9601801 (2018).
- 608 35. Fani, L., *et al.* Circulating biomarkers of immunity and inflammation, risk of Alzheimer's  
609 disease, and hippocampal volume: a Mendelian randomization study. *Translational*  
610 *Psychiatry* **11**, 291 (2021).
- 611 36. Walker, K.A., *et al.* Large-scale plasma proteomic analysis identifies proteins and pathways  
612 associated with dementia risk. *Nature Aging* **1**, 473-489 (2021).
- 613 37. von Boehmer, H. & Melchers, F. Checkpoints in lymphocyte development and autoimmune  
614 disease. *Nat Immunol* **11**, 14-20 (2010).
- 615 38. Theofilopoulos, A.N., Kono, D.H. & Baccala, R. The multiple pathways to autoimmunity.  
616 *Nat Immunol* **18**, 716-724 (2017).
- 617 39. Buzzetti, R., Zampetti, S. & Maddaloni, E. Adult-onset autoimmune diabetes: current  
618 knowledge and implications for management. *Nat Rev Endocrinol* **13**, 674-686 (2017).
- 619 40. Dendrou, C.A., Petersen, J., Rossjohn, J. & Fugger, L. HLA variation and disease. *Nat Rev*  
620 *Immunol* **18**, 325-339 (2018).
- 621 41. Abbott, N.J. Inflammatory mediators and modulation of blood-brain barrier permeability.  
622 *Cell Mol Neurobiol* **20**, 131-147 (2000).
- 623 42. Furuse, M., *et al.* Direct association of occludin with ZO-1 and its possible involvement in  
624 the localization of occludin at tight junctions. *J Cell Biol* **127**, 1617-1626 (1994).

- 625 43. Li, C., Ma, W., Zhao, Y. & Wang, H. Changes in the expression of endothelial  
626 monocyte-activating polypeptide II in the rat hippocampus following status epilepticus. *Int J*  
627 *Mol Med* **47**, 699-707 (2021).
- 628 44. Thomas, S., *et al.* Novel Colitis Immunotherapy Targets Bin1 and Improves Colon Cell  
629 Barrier Function. *Dig Dis Sci* **61**, 423-432 (2016).
- 630 45. Carmona, F.D., *et al.* Novel identification of the IRF7 region as an antcentromere  
631 autoantibody propensity locus in systemic sclerosis. *Ann Rheum Dis* **71**, 114-119 (2012).
- 632 46. Dalakas, M.C., Alexopoulos, H. & Spaeth, P.J. Complement in neurological disorders and  
633 emerging complement-targeted therapeutics. *Nat Rev Neurol* **16**, 601-617 (2020).
- 634 47. Migliorini, P., Italiani, P., Pratesi, F., Puxeddu, I. & Boraschi, D. The IL-1 family cytokines  
635 and receptors in autoimmune diseases. *Autoimmun Rev* **19**, 102617 (2020).
- 636 48. Nowatzky, J., Manches, O., Khan, S.A., Godefroy, E. & Bhardwaj, N. Modulation of human  
637 Th17 cell responses through complement receptor 3 (CD11 b/CD18) ligation on monocyte-  
638 derived dendritic cells. *J Autoimmun* **92**, 57-66 (2018).
- 639 49. Saade, M., Araujo de Souza, G., Scavone, C. & Kinoshita, P.F. The Role of GPNMB in  
640 Inflammation. *Front Immunol* **12**, 674739 (2021).
- 641 50. Berdnikovs, S., *et al.* PTP1B deficiency exacerbates inflammation and accelerates leukocyte  
642 trafficking in vivo. *J Immunol* **188**, 874-884 (2012).
- 643 51. Kamitaki, N., *et al.* Complement genes contribute sex-biased vulnerability in diverse  
644 disorders. *Nature* **582**, 577-581 (2020).
- 645 52. Meka, R.R., Venkatesha, S.H., Dudics, S., Acharya, B. & Moudgil, K.D. IL-27-induced  
646 modulation of autoimmunity and its therapeutic potential. *Autoimmun Rev* **14**, 1131-1141  
647 (2015).
- 648 53. Xu, W.D., Zhao, Y. & Liu, Y. Insights into IL-37, the role in autoimmune diseases.  
649 *Autoimmun Rev* **14**, 1170-1175 (2015).
- 650 54. Cavalli, G. & Dinarello, C.A. Suppression of inflammation and acquired immunity by IL-  
651 37. *Immunol Rev* **281**, 179-190 (2018).
- 652 55. McGeachy, M.J., Cua, D.J. & Gaffen, S.L. The IL-17 Family of Cytokines in Health and  
653 Disease. *Immunity* **50**, 892-906 (2019).
- 654 56. Brink, R. Regulation of B cell self-tolerance by BAFF. *Semin Immunol* **18**, 276-283 (2006).
- 655 57. Choi, J.W., *et al.* The prognostic significance of VISTA and CD33-positive myeloid cells in  
656 cutaneous melanoma and their relationship with PD-1 expression. *Scientific Reports* **10**,  
657 14372 (2020).
- 658 58. Wang, Q., *et al.* Transient BAFF Blockade Inhibits Type 1 Diabetes Development in  
659 Nonobese Diabetic Mice by Enriching Immunoregulatory B Lymphocytes Sensitive to  
660 Deletion by Anti-CD20 Cotherapy. *J Immunol* **199**, 3757-3770 (2017).
- 661 59. Yamauchi, T., *et al.* T-cell CX3CR1 expression as a dynamic blood-based biomarker of  
662 response to immune checkpoint inhibitors. *Nature Communications* **12**, 1402 (2021).
- 663 60. Dörner, T., Shock, A. & Smith, K.G. CD22 and autoimmune disease. *Int Rev Immunol* **31**,  
664 363-378 (2012).
- 665 61. Gommerman, J.L. & Summers deLuca, L. LTβR and CD40: working together in dendritic  
666 cells to optimize immune responses. *Immunol Rev* **244**, 85-98 (2011).
- 667 62. Maldini, C.R., Ellis, G.I. & Riley, J.L. CAR T cells for infection, autoimmunity and  
668 allotransplantation. *Nat Rev Immunol* **18**, 605-616 (2018).
- 669 63. Schittenhelm, L., Hilkens, C.M. & Morrison, V.L. β(2) Integrins As Regulators of Dendritic  
670 Cell, Monocyte, and Macrophage Function. *Front Immunol* **8**, 1866 (2017).
- 671 64. Wang, J. & Fu, Y.X. The role of LIGHT in T cell-mediated immunity. *Immunol Res* **30**,  
672 201-214 (2004).

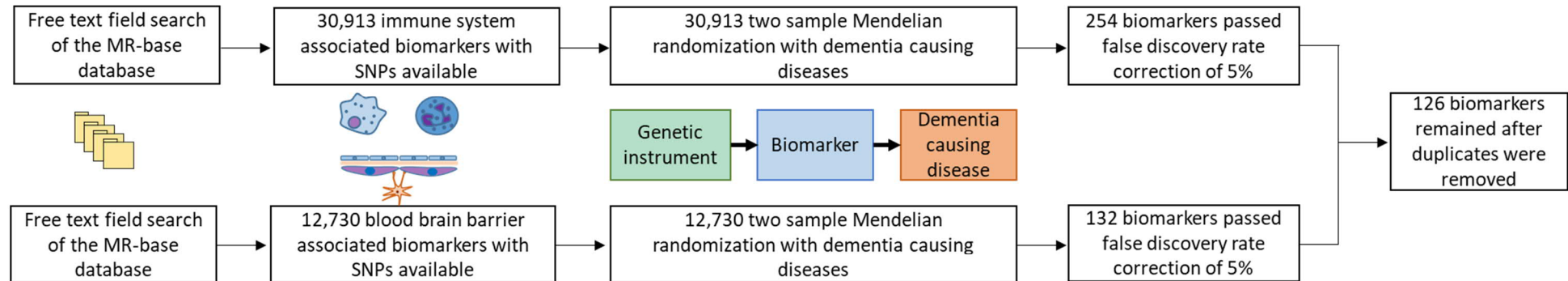
- 673 65. Meffre, E. & O'Connor, K.C. Impaired B-cell tolerance checkpoints promote the  
674 development of autoimmune diseases and pathogenic autoantibodies. *Immunol Rev* **292**, 90-  
675 101 (2019).
- 676 66. Hobeika, E., Nielsen, P.J. & Medgyesi, D. Signaling mechanisms regulating B-lymphocyte  
677 activation and tolerance. *J Mol Med (Berl)* **93**, 143-158 (2015).
- 678 67. Gate, D., *et al.* Clonally expanded CD8 T cells patrol the cerebrospinal fluid in Alzheimer's  
679 disease. *Nature* **577**, 399-404 (2020).
- 680 68. Xiao, D., *et al.* A meta-analysis of interaction between Epstein-Barr virus and HLA-  
681 DRB1\*1501 on risk of multiple sclerosis. *Scientific Reports* **5**, 18083 (2015).
- 682 69. Das Sarma, J., *et al.* Ifit2 deficiency restricts microglial activation and leukocyte migration  
683 following murine coronavirus (m-CoV) CNS infection. *PLoS Pathog* **16**, e1009034 (2020).
- 684 70. Bech-Otschir, D., *et al.* COP9 signalosome-specific phosphorylation targets p53 to  
685 degradation by the ubiquitin system. *Embo j* **20**, 1630-1639 (2001).
- 686 71. Bertram, K., *et al.* Cryo-EM Structure of a Pre-catalytic Human Spliceosome Primed for  
687 Activation. *Cell* **170**, 701-713.e711 (2017).
- 688 72. Choudhary, B., Marx, O. & Norris, A.D. Spliceosomal component PRP-40 is a central  
689 regulator of microexon splicing. *Cell Rep* **36**, 109464 (2021).
- 690 73. Groettrup, M., *et al.* A role for the proteasome regulator PA28alpha in antigen presentation.  
691 *Nature* **381**, 166-168 (1996).
- 692 74. Kamura, T., *et al.* VHL-box and SOCS-box domains determine binding specificity for Cul2-  
693 Rbx1 and Cul5-Rbx2 modules of ubiquitin ligases. *Genes Dev* **18**, 3055-3065 (2004).
- 694 75. Lu, K., Psakhye, I. & Jentsch, S. Autophagic clearance of polyQ proteins mediated by  
695 ubiquitin-Atg8 adaptors of the conserved CUET protein family. *Cell* **158**, 549-563 (2014).
- 696 76. Sturm, M., Cheng, J., Baßler, J., Beckmann, R. & Hurt, E. Interdependent action of KH  
697 domain proteins Krr1 and Dim2 drive the 40S platform assembly. *Nat Commun* **8**, 2213  
698 (2017).
- 699 77. Wada, K. & Kamitani, T. Autoantigen Ro52 is an E3 ubiquitin ligase. *Biochem Biophys Res*  
700 *Commun* **339**, 415-421 (2006).
- 701 78. Yamashita, D., *et al.* hDREF regulates cell proliferation and expression of ribosomal protein  
702 genes. *Mol Cell Biol* **27**, 2003-2013 (2007).
- 703 79. Zhu, X., *et al.* Noc4L-Mediated Ribosome Biogenesis Controls Activation of Regulatory  
704 and Conventional T Cells. *Cell Rep* **27**, 1205-1220.e1204 (2019).
- 705 80. Li, X., Li, R., Lin, X. & Guan, M.X. Isolation and characterization of the putative nuclear  
706 modifier gene MTO1 involved in the pathogenesis of deafness-associated mitochondrial 12  
707 S rRNA A1555G mutation. *J Biol Chem* **277**, 27256-27264 (2002).
- 708 81. Estefanía, E., *et al.* Human KIR2DL5 is an inhibitory receptor expressed on the surface of  
709 NK and T lymphocyte subsets. *J Immunol* **178**, 4402-4410 (2007).
- 710 82. Adly, A.A.M., Ismail, E.A., Tawfik, L.M., Ebeid, F.S.E. & Hassan, A.A.S. Endothelial  
711 monocyte activating polypeptide II in children and adolescents with type 1 diabetes mellitus:  
712 Relation to micro-vascular complications. *Cytokine* **76**, 156-162 (2015).
- 713 83. Dolan, J., *et al.* The extracellular leucine-rich repeat superfamily; a comparative survey and  
714 analysis of evolutionary relationships and expression patterns. *BMC Genomics* **8**, 320  
715 (2007).
- 716 84. García-Heredía, J.M. & Carnero, A. The cargo protein MAP17 (PDZK1IP1) regulates the  
717 immune microenvironment. *Oncotarget* **8**, 98580-98597 (2017).
- 718 85. Yamazaki, Y., Zhao, N., Caulfield, T.R., Liu, C.C. & Bu, G. Apolipoprotein E and  
719 Alzheimer disease: pathobiology and targeting strategies. *Nat Rev Neurol* **15**, 501-518  
720 (2019).
- 721 86. Naj, A.C., *et al.* Common variants at MS4A4/MS4A6E, CD2AP, CD33 and EPHA1 are  
722 associated with late-onset Alzheimer's disease. *Nat Genet* **43**, 436-441 (2011).

- 723 87. Torres-Acosta, N., O'Keefe, J.H., O'Keefe, E.L., Isaacson, R. & Small, G. Therapeutic  
724 Potential of TNF- $\alpha$  Inhibition for Alzheimer's Disease Prevention. *J Alzheimers Dis* **78**, 619-  
725 626 (2020).
- 726 88. Judge, A., *et al.* Protective effect of antirheumatic drugs on dementia in rheumatoid arthritis  
727 patients. *Alzheimers Dement (N Y)* **3**, 612-621 (2017).
- 728 89. Chen, A.Y., Wolchok, J.D. & Bass, A.R. TNF in the era of immune checkpoint inhibitors:  
729 friend or foe? *Nature Reviews Rheumatology* **17**, 213-223 (2021).
- 730 90. Aisen, P.S., *et al.* Effects of Rofecoxib or Naproxen vs Placebo on Alzheimer Disease  
731 Progression A Randomized Controlled Trial. *JAMA* **289**, 2819-2826 (2003).
- 732 91. Butchart, J., *et al.* Etanercept in Alzheimer disease: A randomized, placebo-controlled,  
733 double-blind, phase 2 trial. *Neurology* **84**, 2161-2168 (2015).
- 734 92. Herwig, R., Hardt, C., Lienhard, M. & Kamburov, A. Analyzing and interpreting genome  
735 data at the network level with ConsensusPathDB. *Nature Protocols* **11**, 1889-1907 (2016).
- 736 93. Hernán, M.A. & Robins, J.M. Using Big Data to Emulate a Target Trial When a  
737 Randomized Trial Is Not Available. *Am J Epidemiol* **183**, 758-764 (2016).
- 738 94. Hemani, G., *et al.* The MR-Base platform supports systematic causal inference across the  
739 human phenome. *Elife* **7**(2018).
- 740 95. Akiyama, H., *et al.* Inflammation and Alzheimer's disease. *Neurobiology of aging* **21**, 383-  
741 421 (2000).
- 742 96. O'Brien, J.T. & Thomas, A. Vascular dementia. *Lancet (London, England)* **386**, 1698-1706  
743 (2015).
- 744 97. UniProt, C. UniProt: a worldwide hub of protein knowledge. *Nucleic acids research* **47**,  
745 D506-D515 (2019).
- 746 98. <http://www.nealelab.is/uk-biobank/>.
- 747 99. Kivimaki, M., *et al.* Validity of Cardiovascular Disease Event Ascertainment Using Linkage  
748 to UK Hospital Records. *Epidemiology (Cambridge, Mass.)* **28**, 735-739 (2017).
- 749 100. Sommerlad, A., *et al.* Accuracy of general hospital dementia diagnoses in England:  
750 Sensitivity, specificity, and predictors of diagnostic accuracy 2008-2016. *Alzheimer's &*  
751 *dementia : the journal of the Alzheimer's Association* **14**, 933-943 (2018).
- 752 101. Gold, L., *et al.* Aptamer-based multiplexed proteomic technology for biomarker discovery.  
753 *PloS one* **5**, e15004 (2010).
- 754 102. Williams, S.A., *et al.* Plasma protein patterns as comprehensive indicators of health. *Nature*  
755 *medicine* **25**, 1851-1857 (2019).
- 756 103. Bolla, M.K., Wood, N. & Humphries, S.E. Rapid determination of apolipoprotein E  
757 genotype using a heteroduplex generator. *Journal of lipid research* **40**, 2340-2345 (1999).
- 758 104. Miller, S.A., Dykes, D.D. & Polesky, H.F. A simple salting out procedure for extracting  
759 DNA from human nucleated cells. *Nucleic acids research* **16**, 1215 (1988).
- 760 105. Cox, D.R. Regression Models and Life-Tables. *Journal of the Royal Statistical*  
761 *Society.Series B (Methodological)* **34**, 187-220 (1972).
- 762 106. Dickerman, B.A., García-Albéniz, X., Logan, R.W., Denaxas, S. & Hernán, M.A. Avoidable  
763 flaws in observational analyses: an application to statins and cancer. *Nat Med* **25**, 1601-1606  
764 (2019).
- 765 107. Ritari, J., Hyvärinen, K., Clancy, J., Partanen, J. & Koskela, S. Increasing accuracy of HLA  
766 imputation by a population-specific reference panel in a FinnGen biobank cohort. *NAR*  
767 *Genom Bioinform* **2**, lqaa030 (2020).
- 768 108. Luo, W., Friedman, M.S., Shedden, K., Hankenson, K.D. & Woolf, P.J. GAGE: generally  
769 applicable gene set enrichment for pathway analysis. *BMC Bioinformatics* **10**, 161 (2009).
- 770 109. Bindea, G., *et al.* ClueGO: a Cytoscape plug-in to decipher functionally grouped gene  
771 ontology and pathway annotation networks. *Bioinformatics* **25**, 1091-1093 (2009).

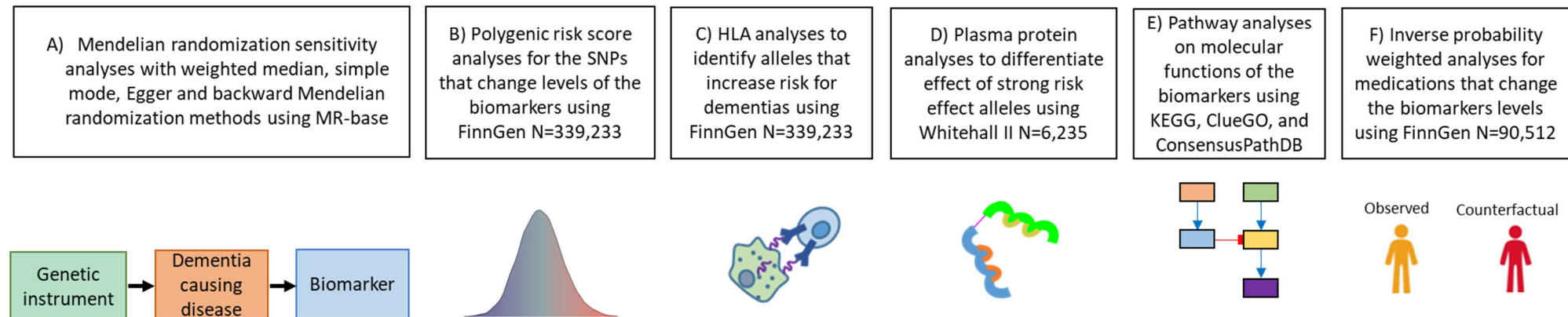
- 772 110. Shannon, P., *et al.* Cytoscape: a software environment for integrated models of biomolecular  
773 interaction networks. *Genome Res* **13**, 2498-2504 (2003).  
774  
775  
776  
777  
778

**Figure 1.** Flowchart of the study design. HLA, human leukocyte antigen; KEGG, Kyoto Encyclopedia of Genes and Genomes; PRS, polygenic risk score; SNP, single nucleotide polymorphism.

### 1) Biomarker discovery step: two-sample Mendelian randomization analyses



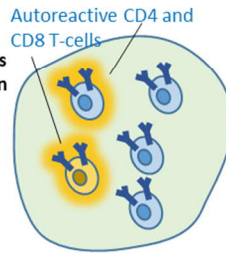
### 2) Validation step for the 126 biomarkers: triangulation analyses



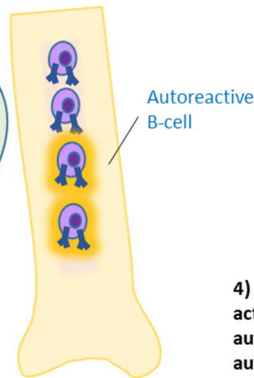
**Figure 2.** The autoimmune hypothesis of diseases causing dementias, the supporting evidence from current analyses are listed at each mechanism. BBB, blood brain barrier; CD, cluster of differentiation; CNS, central nervous system; HLA, Human Leukocyte Antigen; cluster of differentiation; IPW, inverse probability weighted;

### Central immune organs

#### Thymus



#### Bone marrow



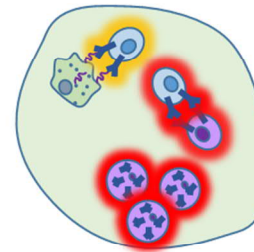
1) Increased production of primed mature autoreactive B-cells and CD4 and CD8 T-cells due to failed positive and negative selection in bone marrow and thymus.

Supporting evidence from:

- Mendelian randomization
- Polygenic risk scores
- HLA analyses
- Pathway analyses

### Secondary immune organs

#### Lymph node

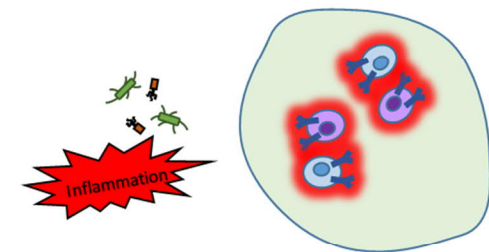


4) Antigen-presenting cells migrate to lymph nodes and activate autoreactive CD4 T-helper cells that activate autoreactive B-cells to plasma cells that secrete autoantibodies.

Supporting evidence from:

- Mendelian randomization
- HLA analyses
- Pathway analyses

#### Lymph node



6) Memory cells for autoantigens are formed and they react to reoccurring inflammation, tissue damage and infections. This sustains autoimmune driven neuroinflammation that causes permanent damage to CNS.

Supporting evidence from:

- Mendelian randomization
- Plasma proteomics
- IPW analyses
- Pathway analyses

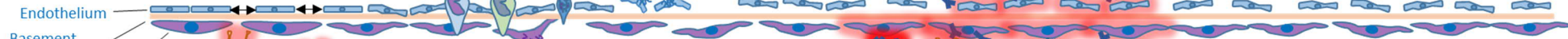
### Capillary

2) Chronic antigen stimulation and increased inflammation reduces energy and allows more autoreactive cells to proliferate. It also degrades BBB that leads to contact between autoreactive peripheral and CNS epitopes.

Supporting evidence from:

- Mendelian randomization
- Plasma proteomics
- IPW analyses
- Pathway analyses

### Blood brain barrier



3) Inflammation, tissue damage, and infections activate autoreactive B- and T-cells via bystander activation or antigen presentation mediated molecular mimicry and cryptic epitopes. Autoreactive CD8-cells attack CNS cells. Inflammation increases amyloid production.

Supporting evidence from:

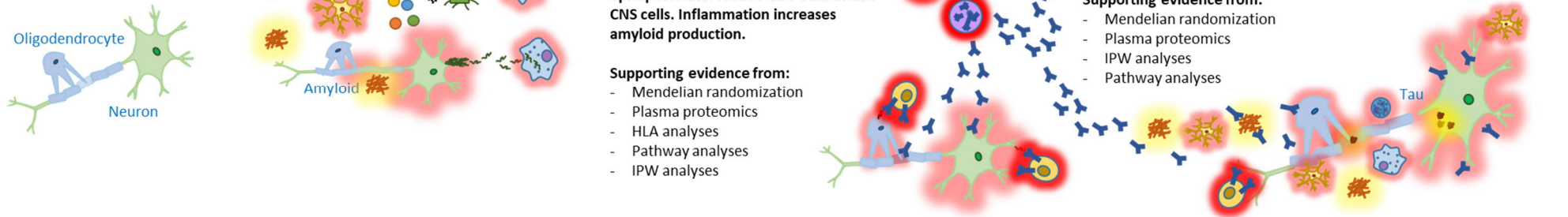
- Mendelian randomization
- Plasma proteomics
- HLA analyses
- Pathway analyses
- IPW analyses

5) Autoantibodies and peripheral leukocytes infiltrate CNS, activate microglia, and sustain neuroinflammation. This leads to neurodegeneration and formation of amyloid  $\beta$ , tau protein, and  $\alpha$ -synuclein that further increase neuroinflammation.

Supporting evidence from:

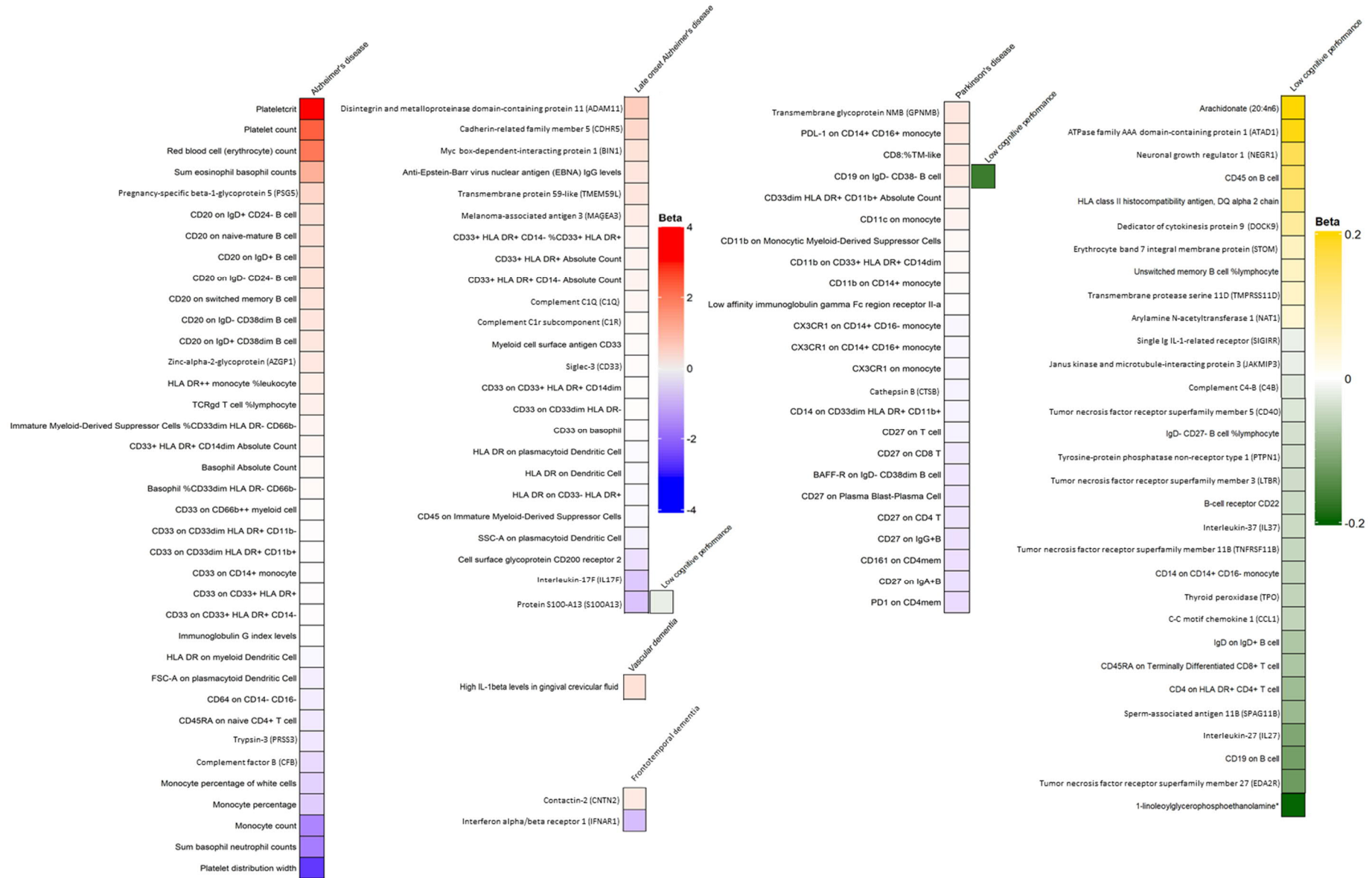
- Mendelian randomization
- Plasma proteomics
- IPW analyses
- Pathway analyses

### Central nervous system



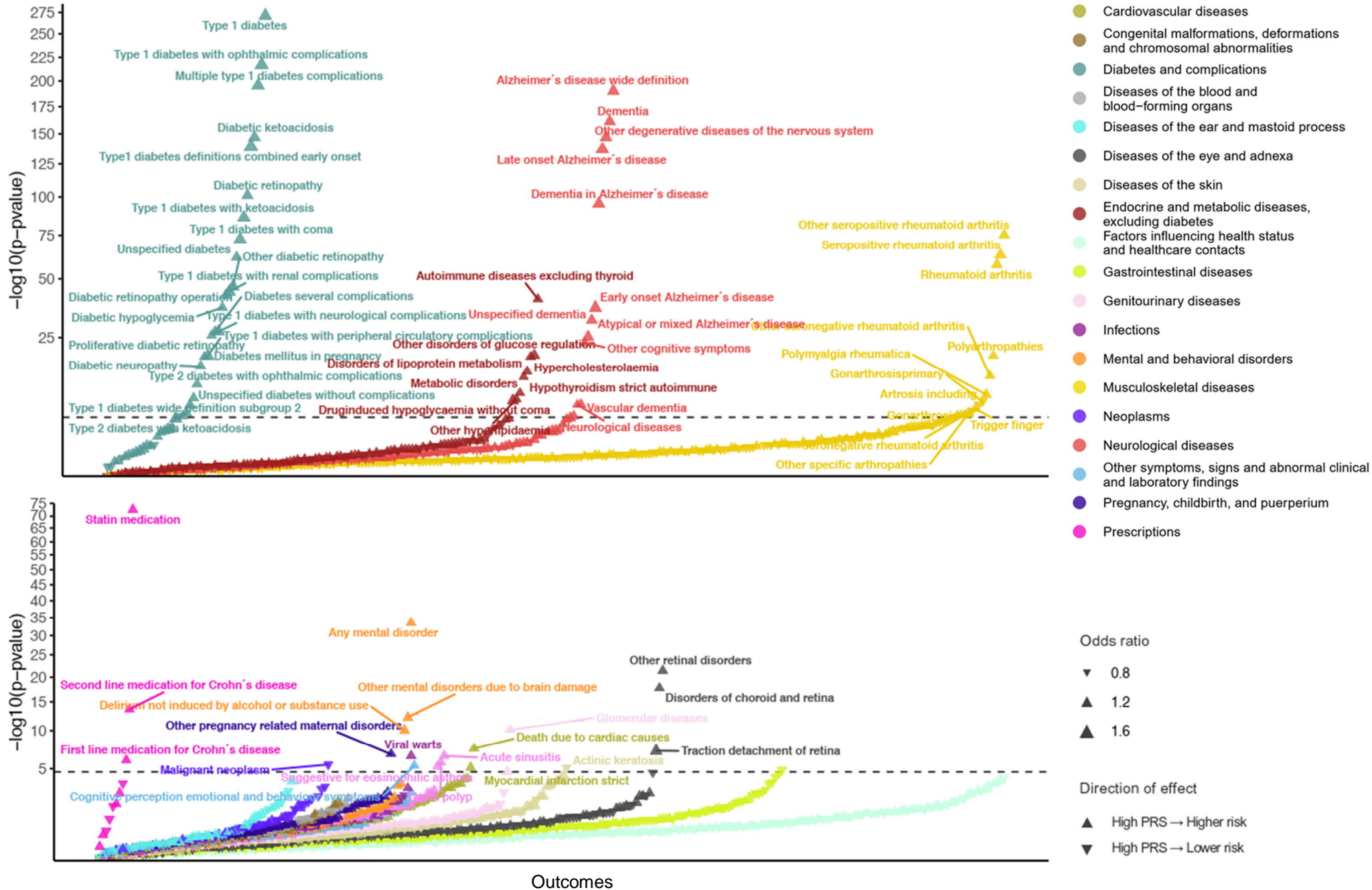


**Figure 3A.** Wald ratio or inverse variance weighted Mendelian randomization estimates for outcome-specific biomarkers.



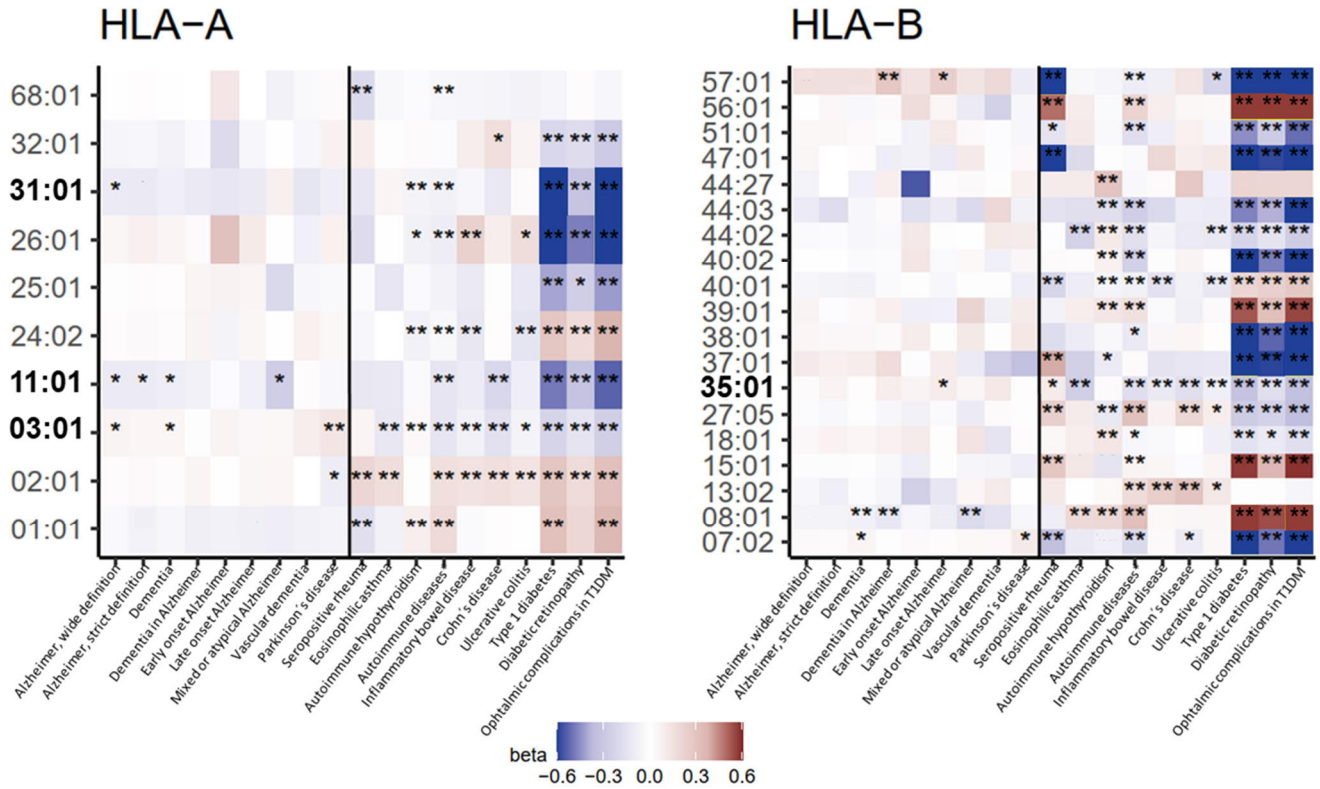


**Figure 4.** Phenome-wide association analyses for a Mendelian randomization-based polygenic risk score constructed only from SNPs that associated with levels of causal Alzheimer's disease biomarkers in Mendelian randomization Wald ratio or inverse variance weighted analyses. Upward pointing triangle means risk increasing and downward risk decreasing. Larger triangle indicates larger effect size.

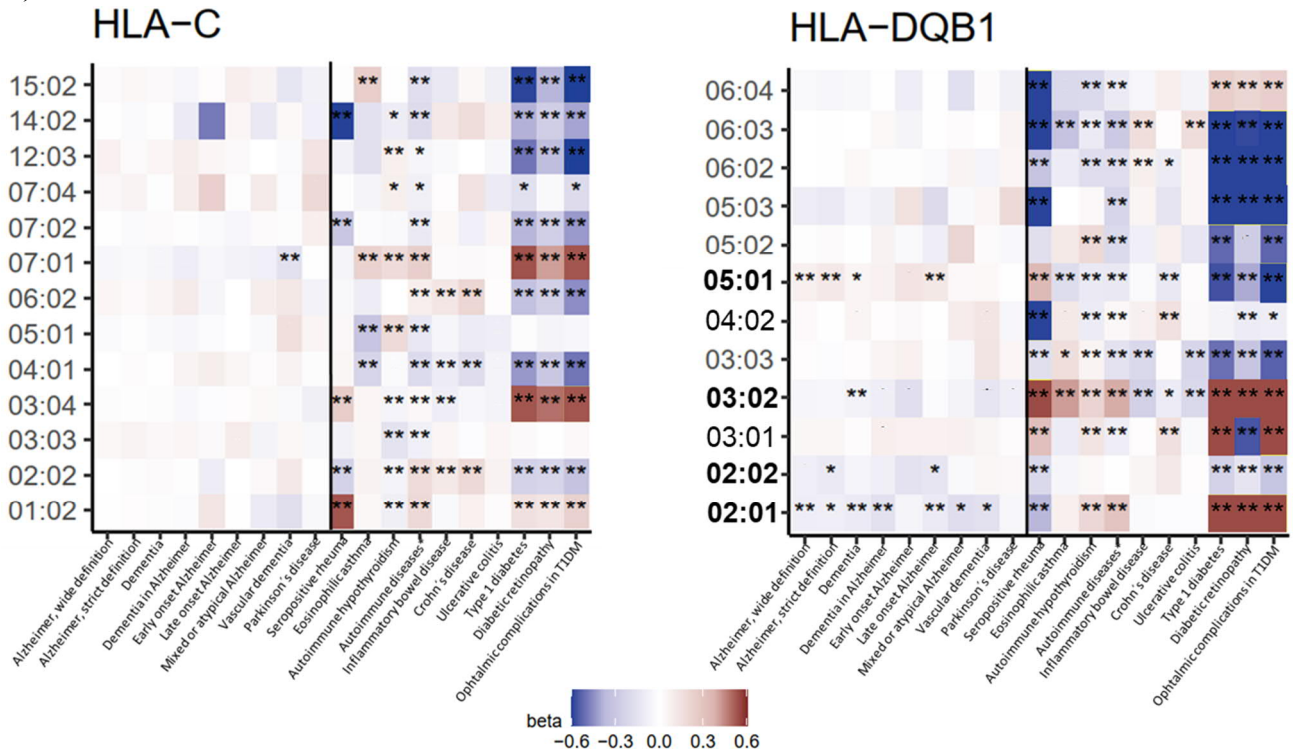


**Figure 5A-E.** Association between different HLA-allele subclasses (y-axis) and dementia causing diseases, autoimmune diseases and their complications (x-axis). The HLA-types with at least one directionally consistent association with autoimmune diseases are bolded. Left side of the panel describes dementias and right side autoimmune diseases and their complications. \*, false discovery rate  $p < 0.02$ ; \*\*,  $p < 0.01$ .

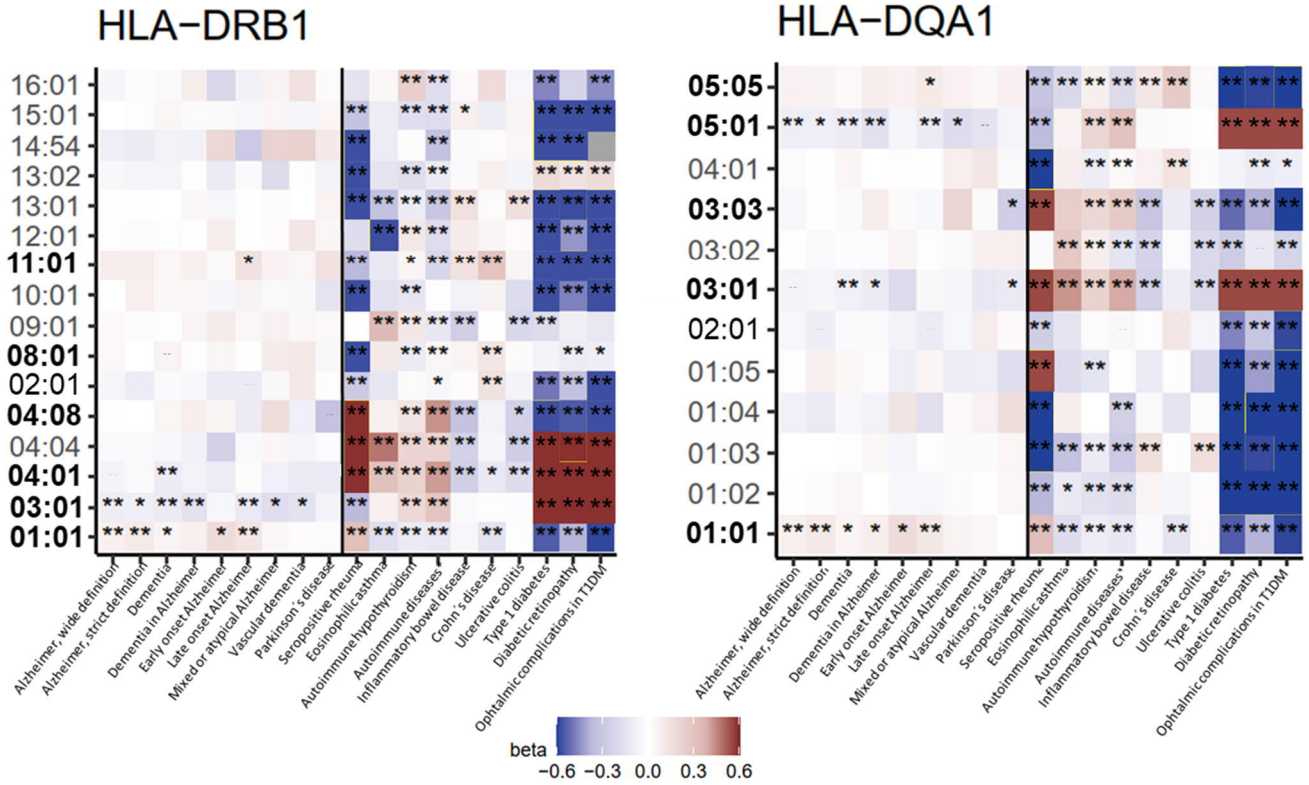
A)



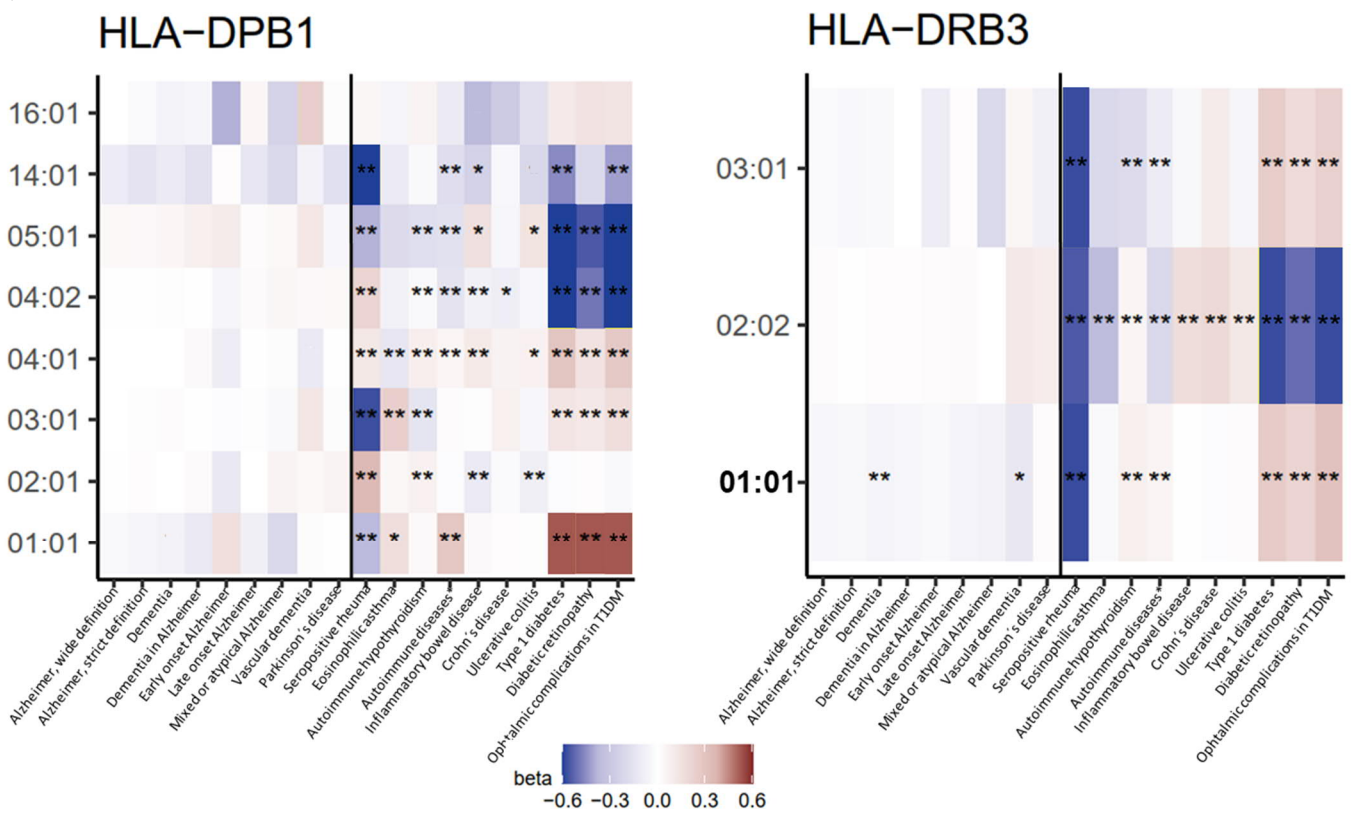
B)



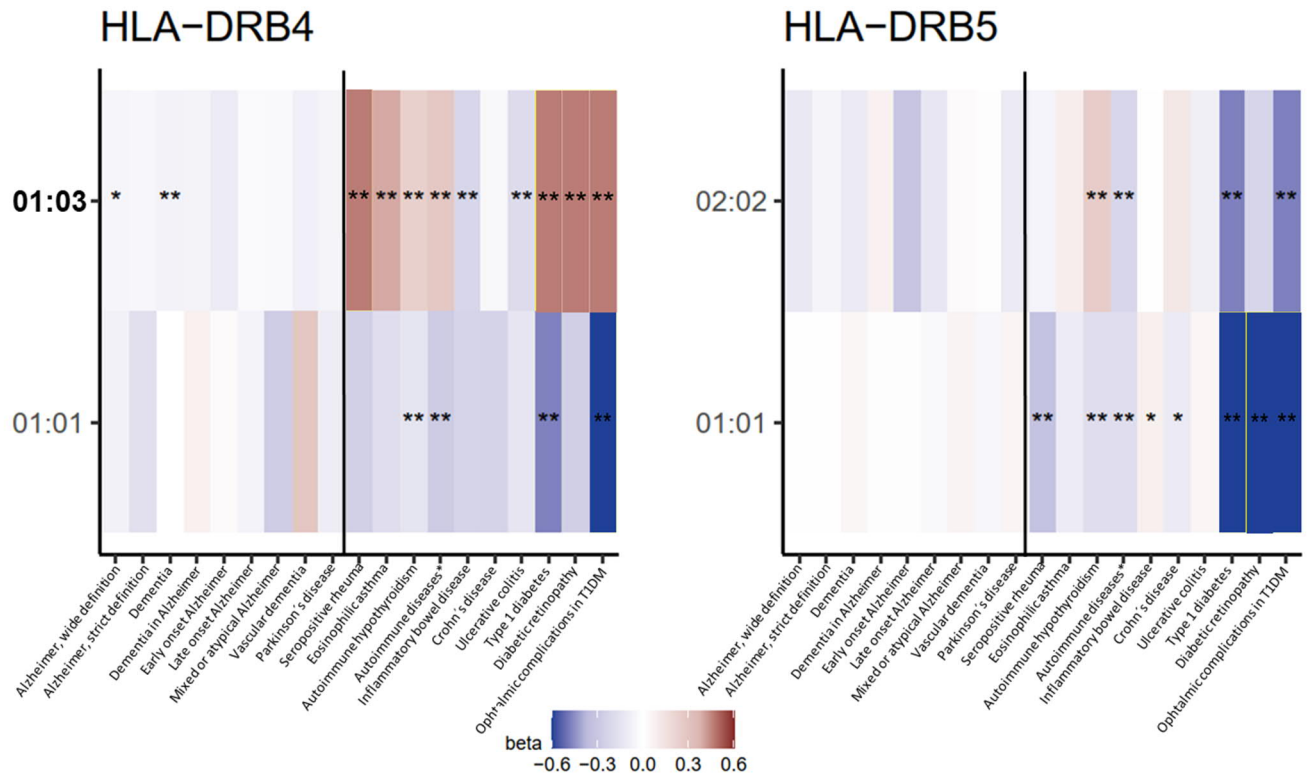
C)



D)



E)





**Table 1.** Associations between dementias and anti-inflammatory medications from inverse probability weighted (IPW) analyses in the FinnGen study. The positive control IPW analyses validate the analysis protocol by replicating association between statin medication and coronary heart disease. The negative control IPW analyses validate the associations between each anti-inflammatory medication and dementias by replicating the null finding between anti-inflammatory medications and coronary heart disease.

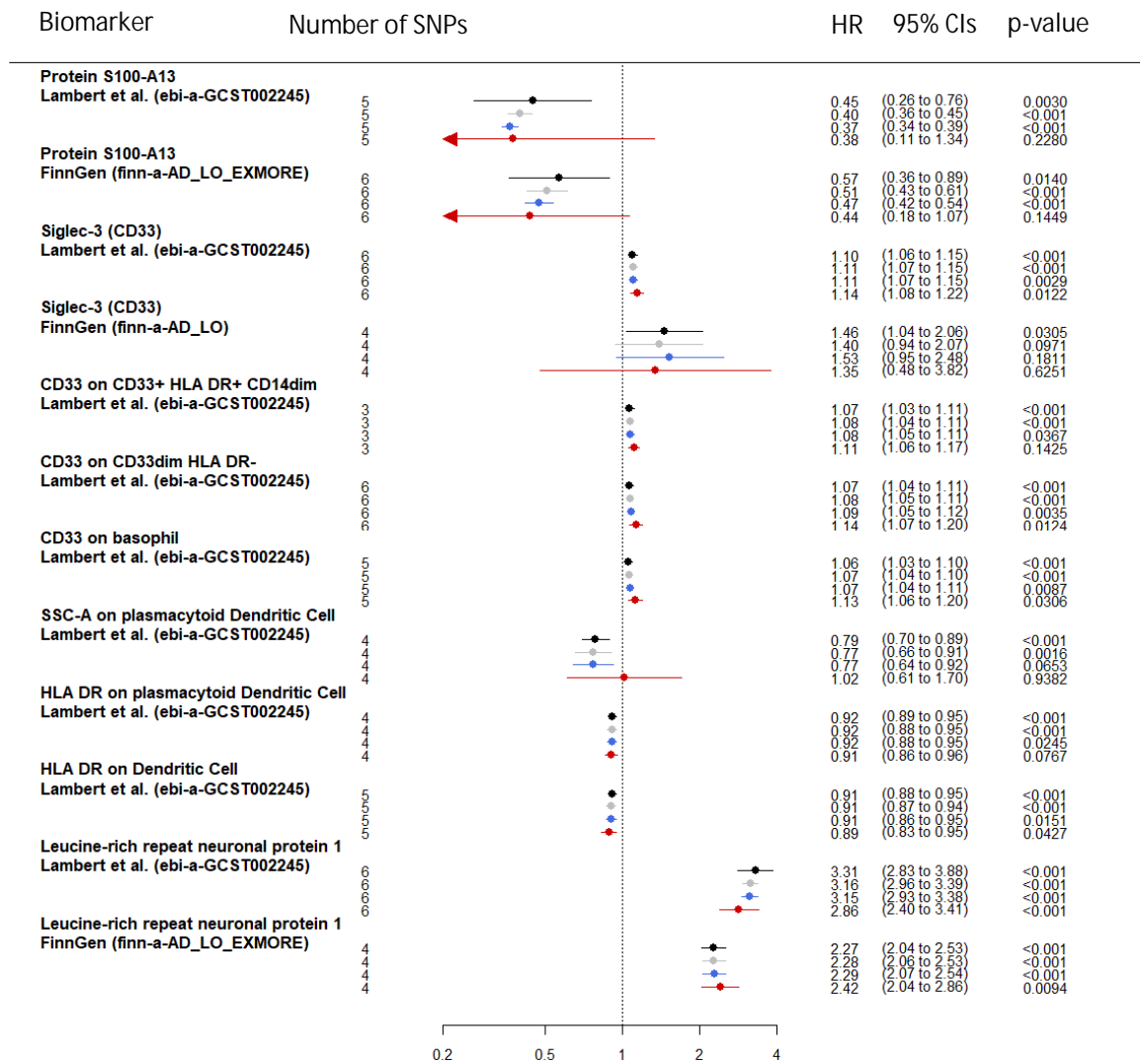
The baseline variables in IPW analyses were birth year, sex, ten principal components and time-varying variables statin, ACE-blocker, AT-blocker, renin-blocker, calcium channel blocker, any diuretic, insulin, metformin, other diabetes drug, depression medication, antipsychotic, and anticoagulant use as well as time varying any cancer, myocardial infarction, atrial fibrillation, heart failure, venous thromboembolism, ischemic stroke, intracerebral haemorrhage, subarachnoid haemorrhage, obesity, sleep apnoea, and chronic obstructive pulmonary diseases, with informative censoring included. Because of limited number of participants, TNF- $\alpha$  inhibitors users in dementias include also baseline users, other analyses include only medication-free individuals at baseline. The estimates for randomized control trials are from references 14 to 17. Secondary prevention randomized control trial was used for methotrexate because no primary prevention trial was available. MR-PRS, Mendelian randomization based polygenic risk score for Alzheimer's disease; NSAID, non-steroidal anti-inflammatory drugs; TNF- $\alpha$ , tumor necrosis factor  $\alpha$ ; IPW, inverse probability weighted analyses; RCT, randomized control trials.

| Medication                        | Disease                                | HR and 95% CIs      | p-value |
|-----------------------------------|--|---------------------|---------|
| <b>Statins</b>                    |  |                     |         |
| Positive control for IPW protocol | Coronary heart disease IPW             | 0.38 (0.19 to 0.78) | 0.009   |
|                                   | Coronary heart disease RCT             | 0.39 (0.29 to 0.49) | <0.001  |
| Methotrexate                      | Alzheimer's disease                    | 0.71 (0.56 to 0.90) | 0.004   |
|                                   | Alzheimer's disease MR-PRS $\geq 50\%$ | 0.64 (0.49 to 0.88) | 0.005   |
|                                   | Alzheimer's disease MR-PRS $< 50\%$    | 0.84 (0.59 to 1.19) | 0.330   |
|                                   | Vascular dementia                      | 0.64 (0.30 to 1.37) | 0.253   |
|                                   | Parkinson's disease                    | 0.48 (0.29 to 0.81) | 0.006   |
|                                   | Parkinson's disease MR-PRS $\geq 50\%$ | 0.20 (0.05 to 0.83) | 0.027   |
|                                   | Parkinson's disease MR-PRS $< 50\%$    | 0.61 (0.08 to 4.37) | 0.622   |
| Negative control                  | Coronary heart disease IPW             | 0.97 (0.84 to 1.11) | 0.647   |
|                                   | Coronary heart disease RCT             | 0.96 (0.79 to 1.16) | 0.862   |
| TNF- $\alpha$ inhibitors          | Alzheimer's disease                    | 0.32 (0.14 to 0.76) | 0.010   |
|                                   | Vascular dementia                      | 0.27 (0.04 to 1.91) | 0.188   |
|                                   | Parkinson's disease                    | 0.26 (0.04 to 1.82) | 0.173   |
| Negative control                  | Coronary heart disease IPW             | 1.03 (0.55 to 1.95) | 0.916   |
|                                   | Coronary heart disease RCT             | 1.09 (0.77 to 1.56) | 0.645   |
| NSAIDs                            | Alzheimer's disease                    | 0.37 (0.35 to 0.40) | <0.001  |
|                                   | Vascular dementia                      | 0.25 (0.20 to 0.32) | <0.001  |
|                                   | Parkinson's disease                    | 0.65 (0.57 to 0.75) | <0.001  |
| Negative control                  | Coronary heart disease IPW             | 0.38 (0.34 to 0.41) | <0.001  |
|                                   | Coronary heart disease RCT             | 1.48 (1.00 to 2.26) | 0.059   |
| Antihistamines                    | Alzheimer's disease                    | 0.54 (0.48 to 0.61) | <0.001  |
|                                   | Vascular dementia                      | 0.43 (0.29 to 0.64) | <0.001  |
|                                   | Parkinson's disease                    | 0.70 (0.56 to 0.89) | 0.003   |
| Negative control                  | Coronary heart disease IPW             | 0.59 (0.51 to 0.69) | 0.009   |
|                                   | Coronary heart disease RCT             | No RCT available    |         |
| Corticosteroids                   | Alzheimer's disease                    | 0.65 (0.40 to 1.06) | 0.085   |
|                                   | Vascular dementia                      | 1.02 (0.32 to 3.21) | 0.972   |
|                                   | Parkinson's disease                    | 0.50 (0.12 to 2.18) | 0.358   |
| Negative control                  | Coronary heart disease IPW             | 0.55 (0.25 to 1.23) | 0.556   |
|                                   | Coronary heart disease RCT             | No RCT available    |         |
| Salazines                         | Alzheimer's disease                    | 0.89 (0.71 to 1.11) | 0.296   |
|                                   | Vascular dementia                      | 0.82 (0.41 to 1.66) | 0.583   |
|                                   | Parkinson's disease                    | 0.69 (0.42 to 1.11) | 0.128   |
| Negative control                  | Coronary heart disease IPW             | 1.06 (0.89 to 1.27) | 0.490   |
|                                   | Coronary heart disease RCT             | No RCT available    |         |

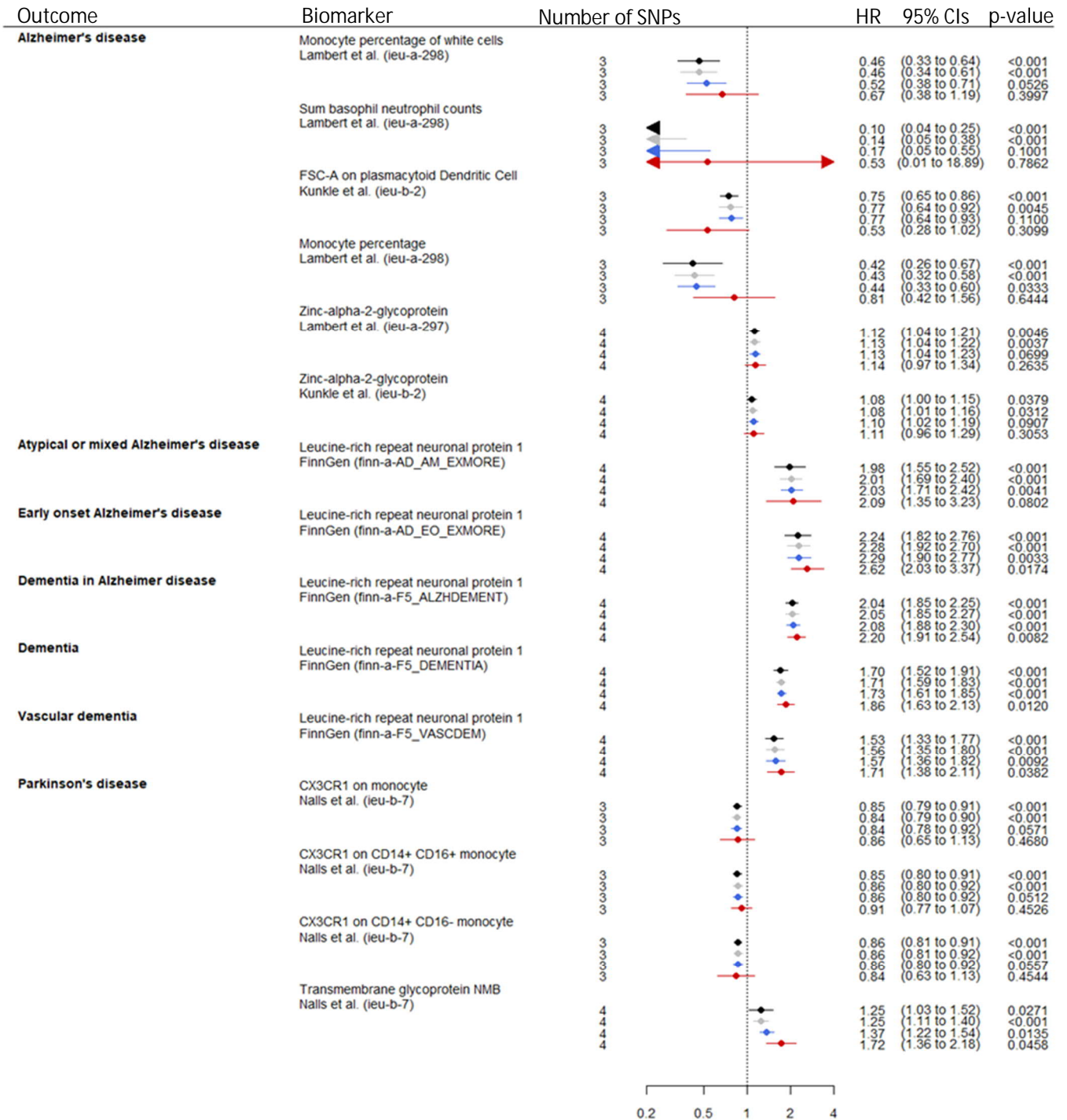
**Supplementary Table 1.** Significant backward Mendelian randomization results with p-value below 0.05. These hazard ratios were not stronger than observed in forward Mendelian randomization analyses in Supplementary Figure 1A and B.

| Exposure                       | Outcome                              | Number of SNPs | HR (95% CIs)        | p-value |
|--------------------------------|--------------------------------------|----------------|---------------------|---------|
| Alzheimer's disease            | FSC-A on plasmacytoid dendritic cell | 20             | 0.85 (0.73 to 0.98) | 0.0275  |
| Late-onset Alzheimer's disease | Protein S100-A13                     | 13             | 0.51 (0.41 to 0.63) | <0.001  |

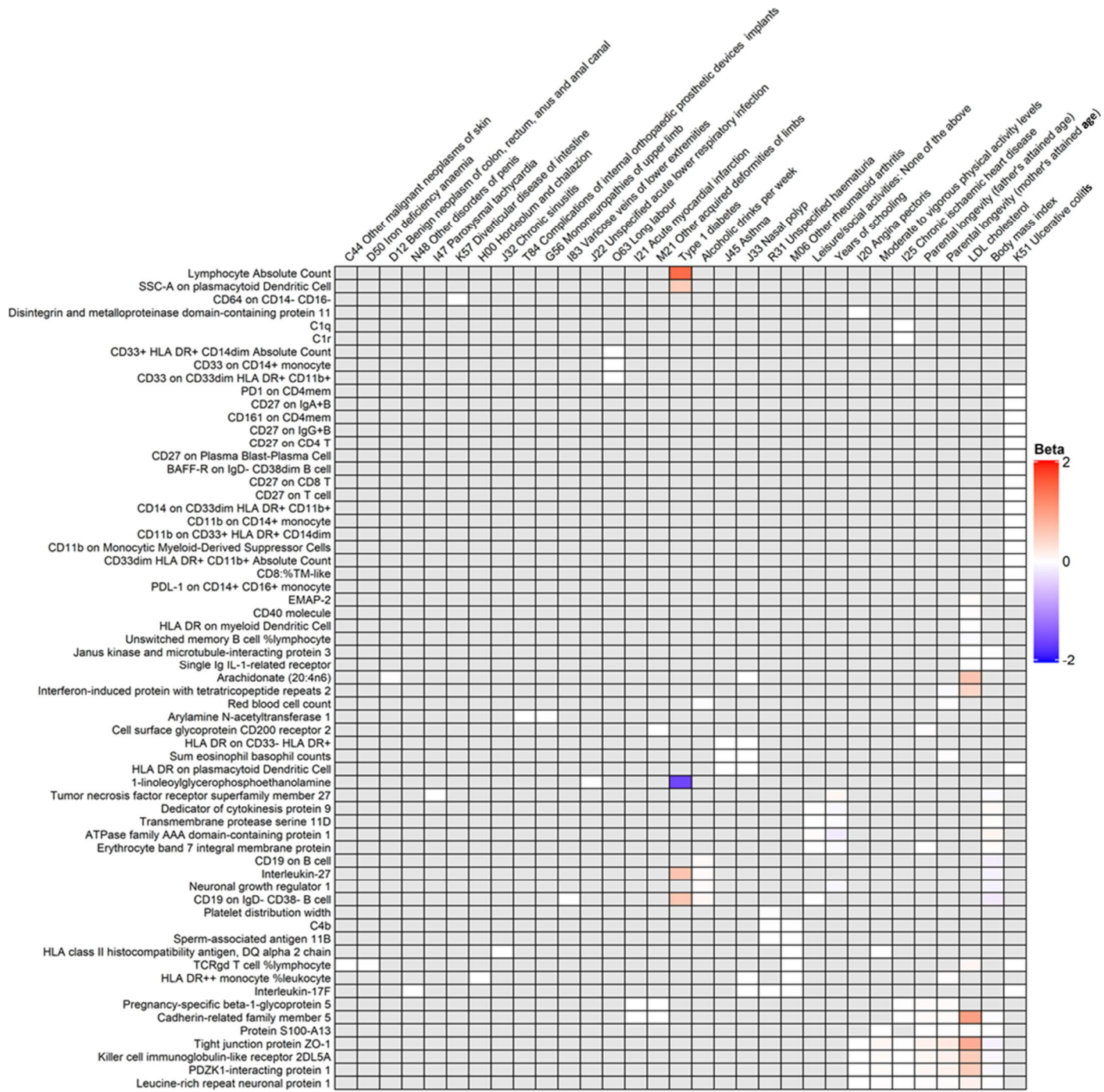
**Supplementary Figure 1A.** Mendelian randomization sensitivity analyses for one standard deviation change in biomarker levels associated with late onset Alzheimer’s diseases and with at least 3 SNPs available. The source of outcome and MR-base outcome identifier is described below the biomarker. Black = inverse variance weighted, grey = weighted median, blue = simple mode, red = Egger Mendelian randomization.



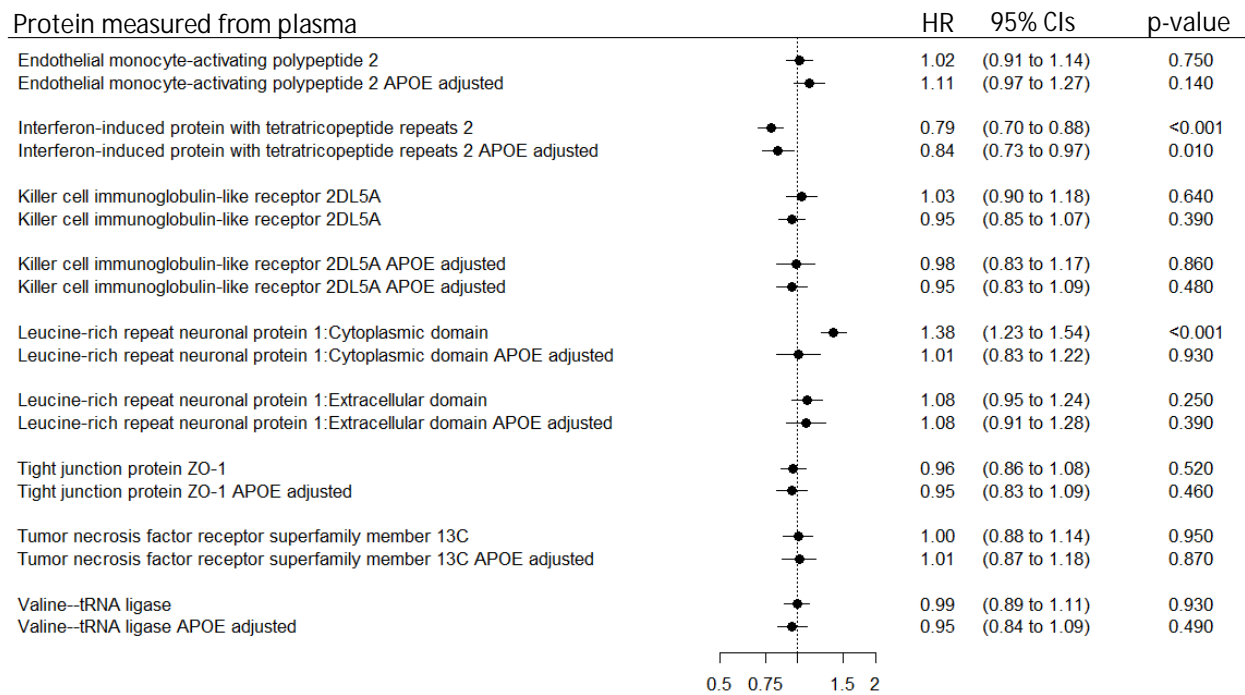
**Supplementary Figure 1B.** Mendelian randomization sensitivity analyses for one standard deviation change in biomarker levels associated with other dementias than late onset Alzheimer’s diseases and with at least 3 SNPs available. The source of outcome and MR-base outcome identifier is described below the Biomarker. Black = inverse variance weighted, grey = weighted median, blue = simple mode, red = Egger Mendelian randomization.



**Supplementary Figure 2.** Phenome-wide association analyses for the 126 biomarkers, effect size describes one standard deviation change in biomarker levels. All biomarker and outcomes pairs that passed false discovery rate correction of 5% are presented. Most biomarkers associated with only few outcomes and the grey boxes indicate no association after false discovery rate correction of 5% or lack of common SNPs.



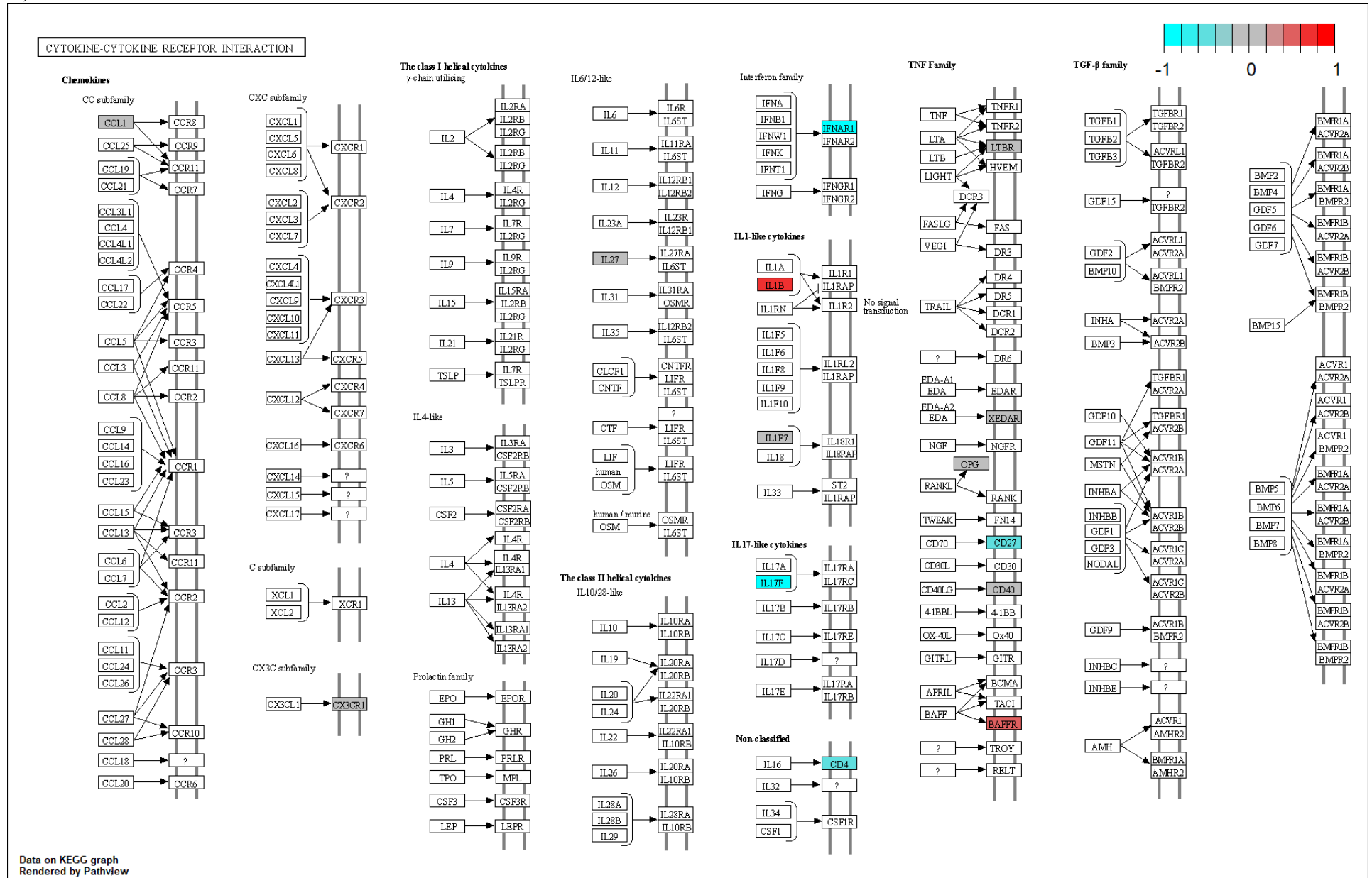
**Supplementary Figure 3.** Plasma protein associations with dementia for one standard deviation change in protein levels from the Whitehall II cohort. The analyses included 8 proteins that had SNPs clustered around *APOE* and associated with at least three dementia subtypes in Mendelian randomization analyses. Analyses are first adjusted for age and sex and then additionally for *APOE* status.



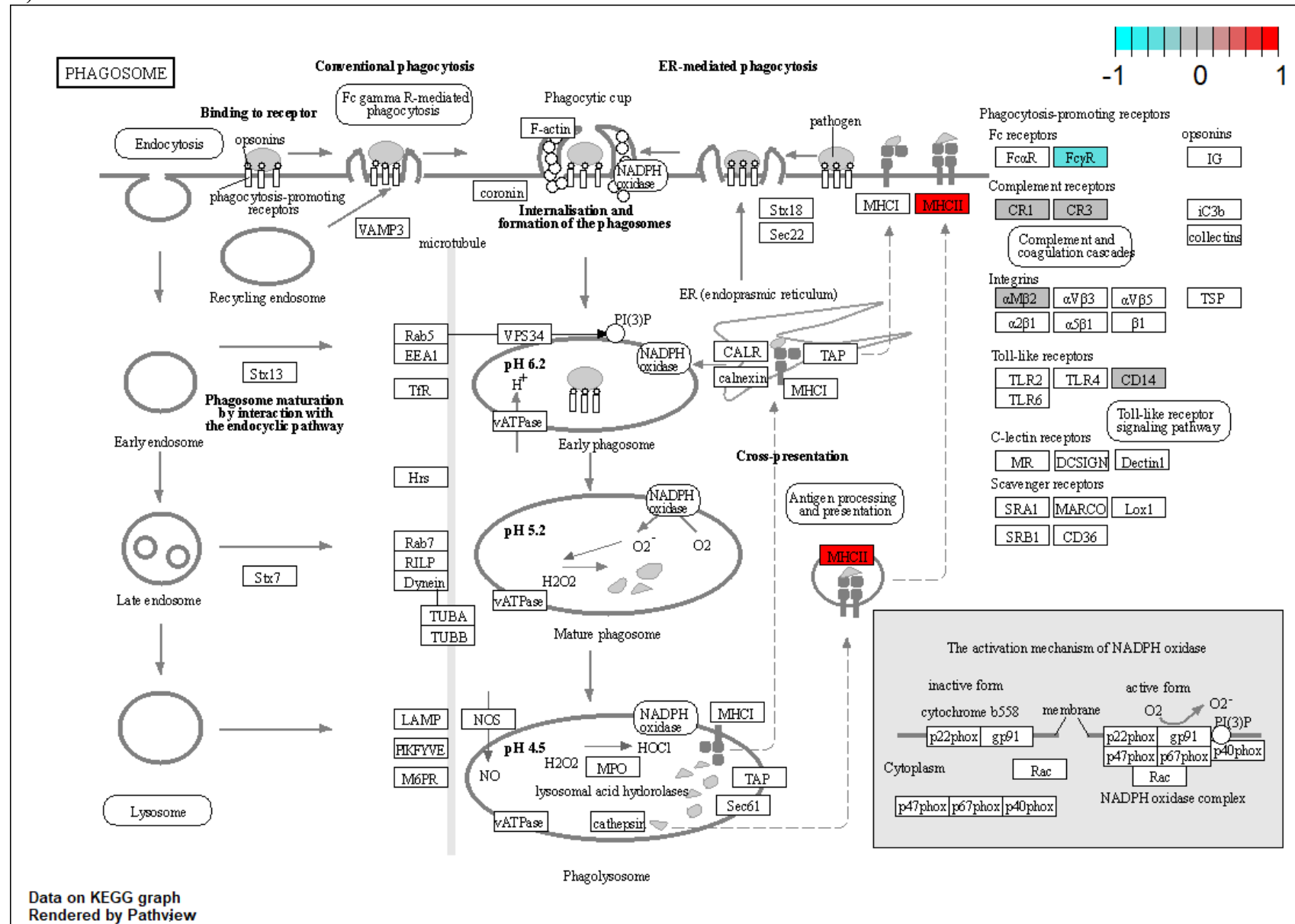
**Supplementary Figures 4 A-H.** KEGG functional pathway enrichment analyses for all proteins and receptors that associated with dementias in Mendelian randomization analyses. The estimated causal betas were used in place of log fold change.



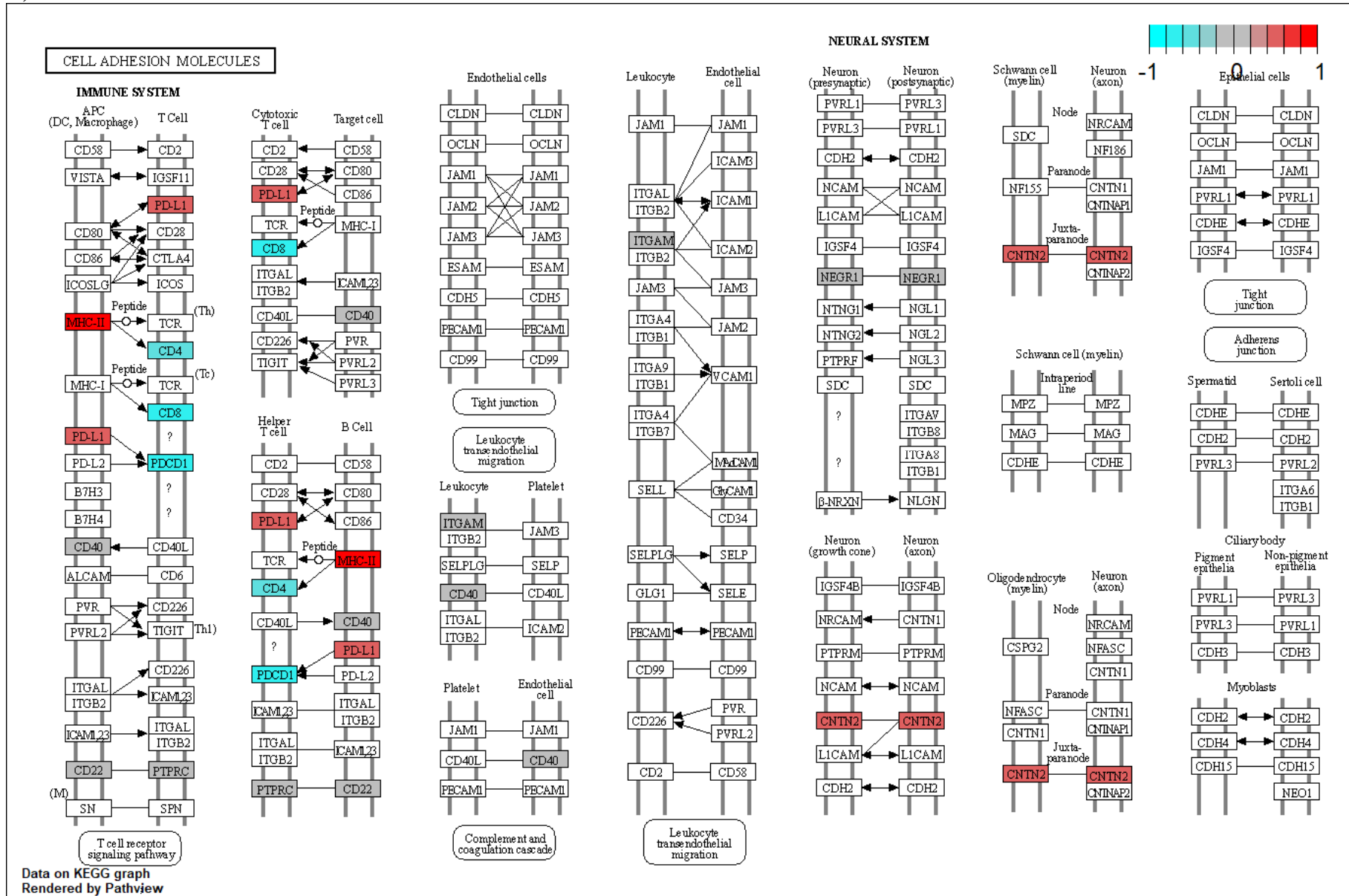
A)



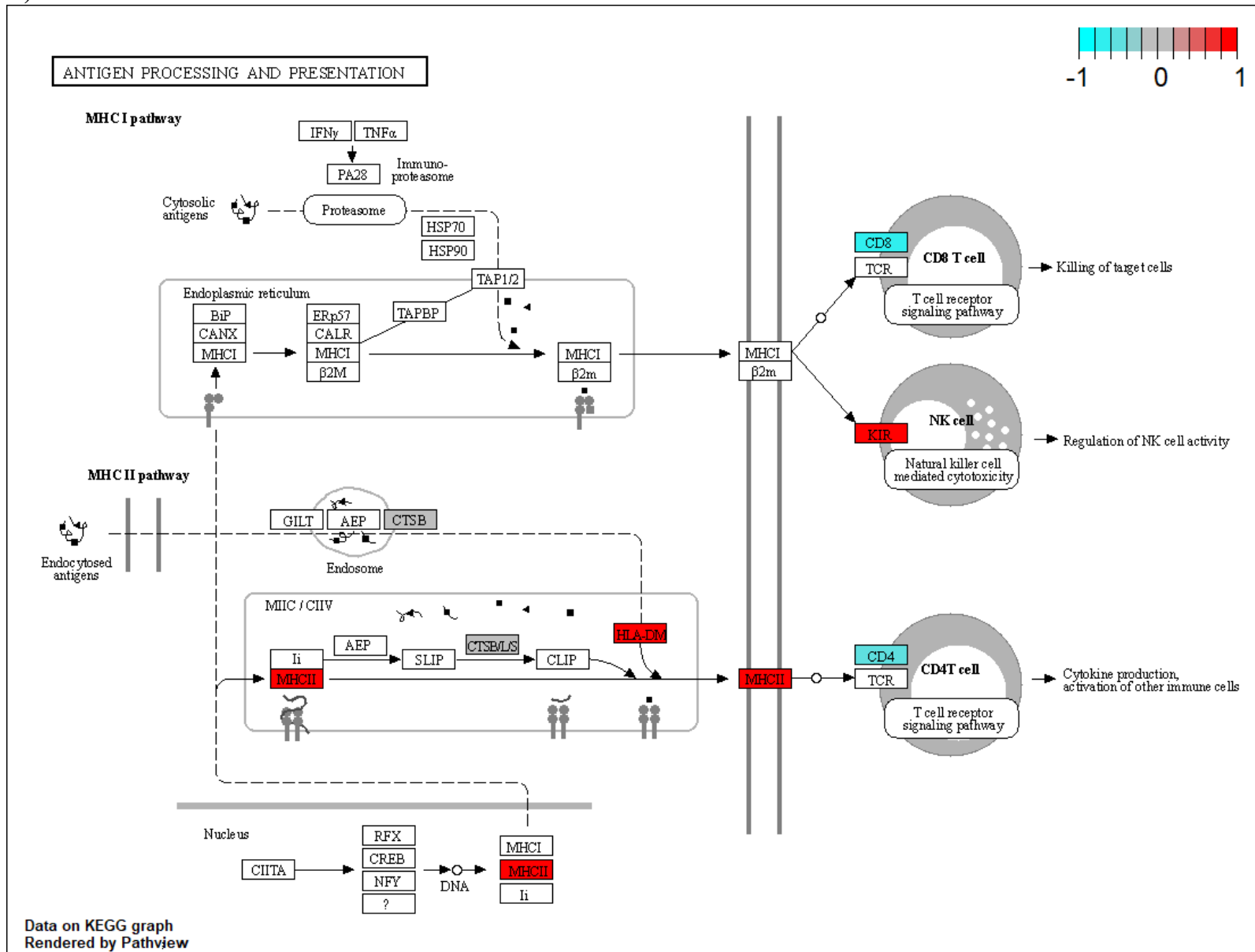
B)



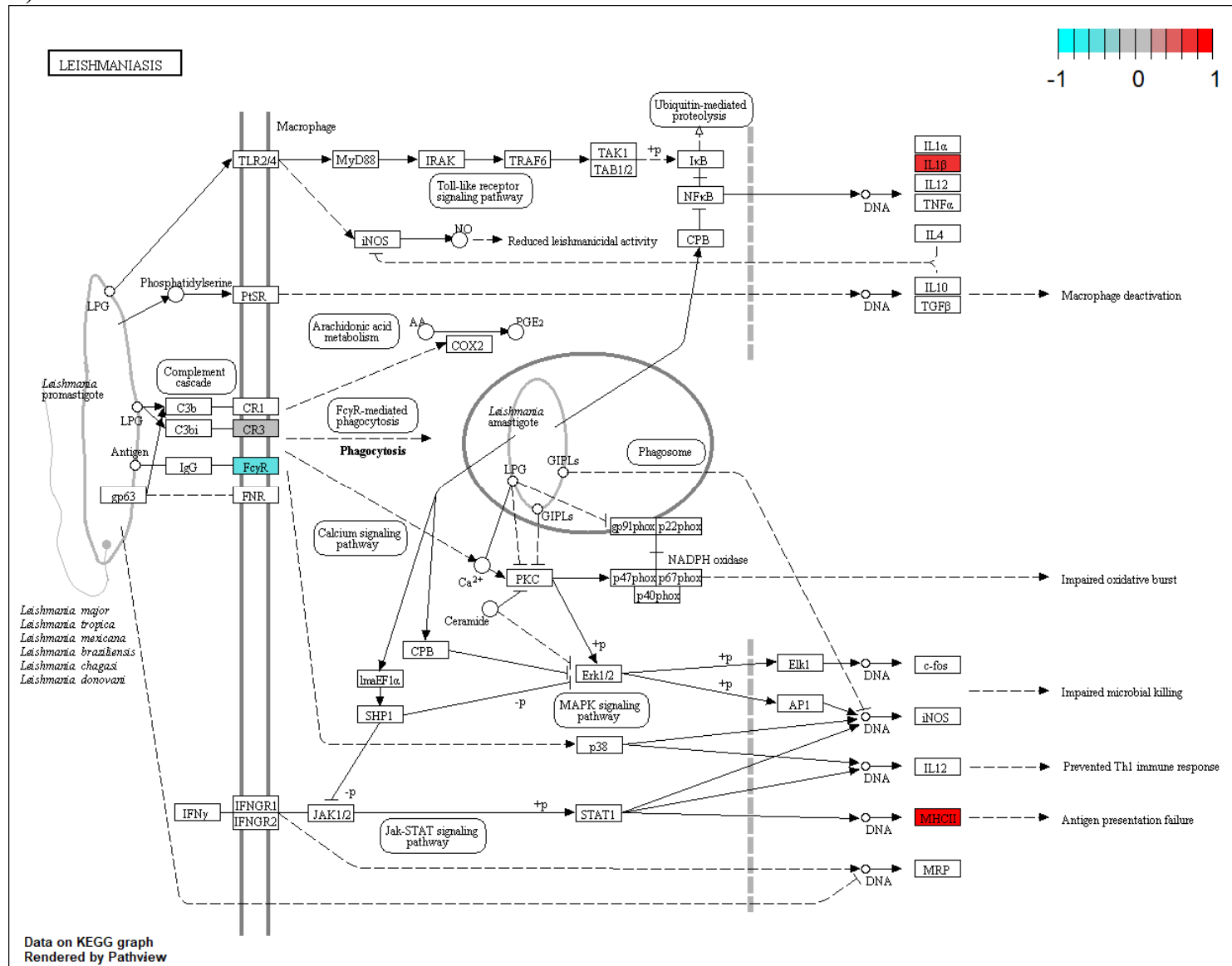
C)

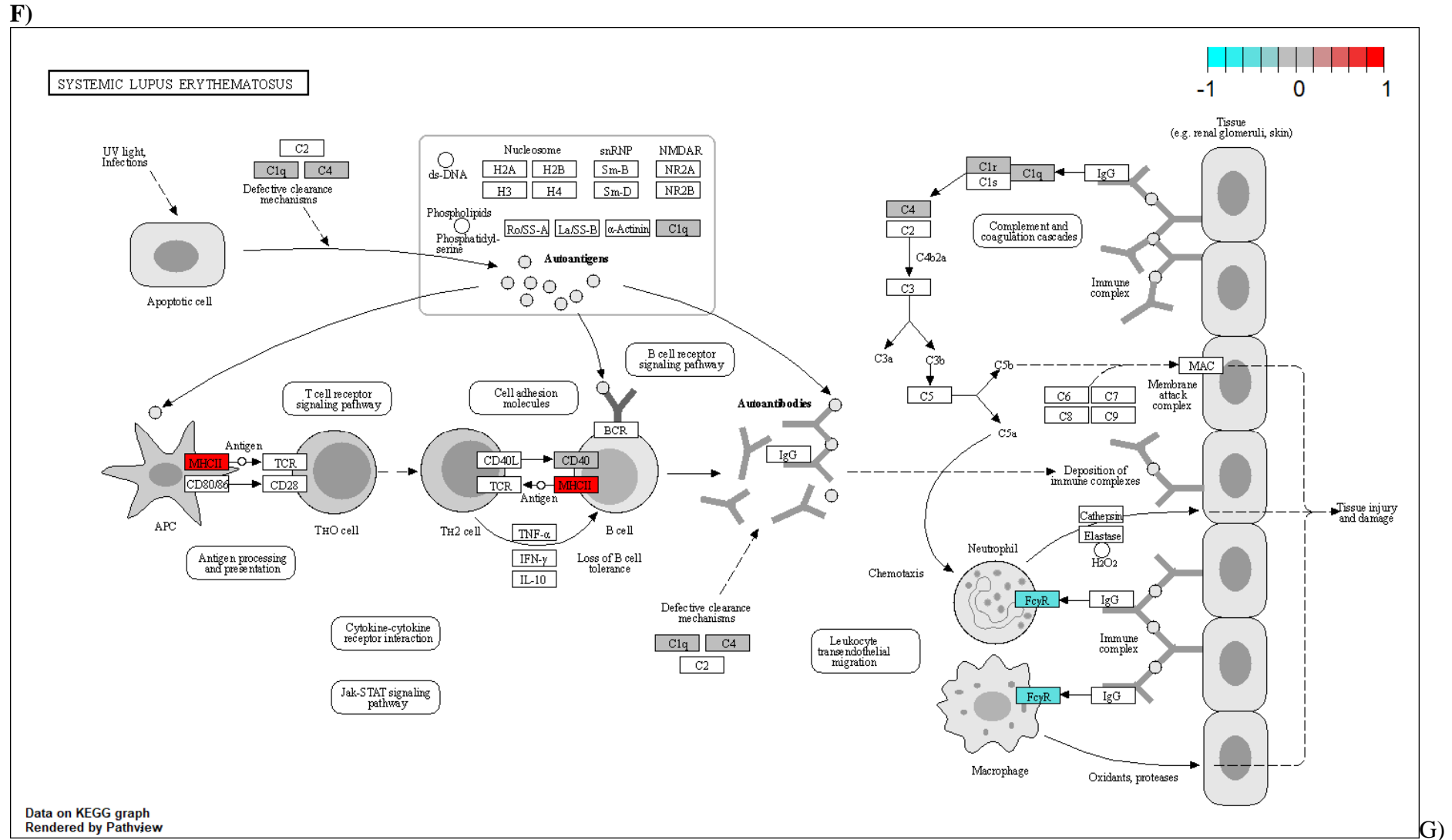


D)

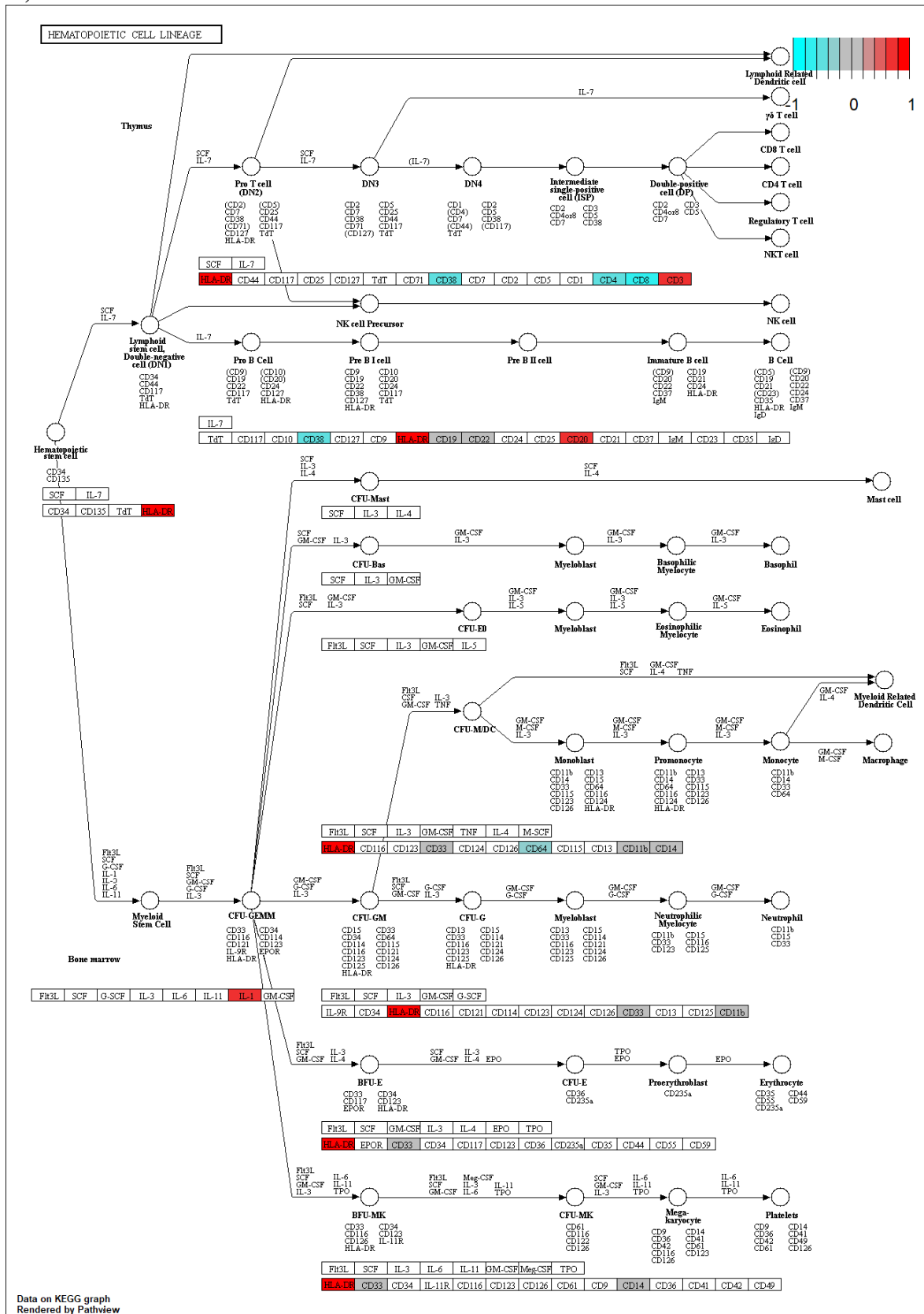


E)

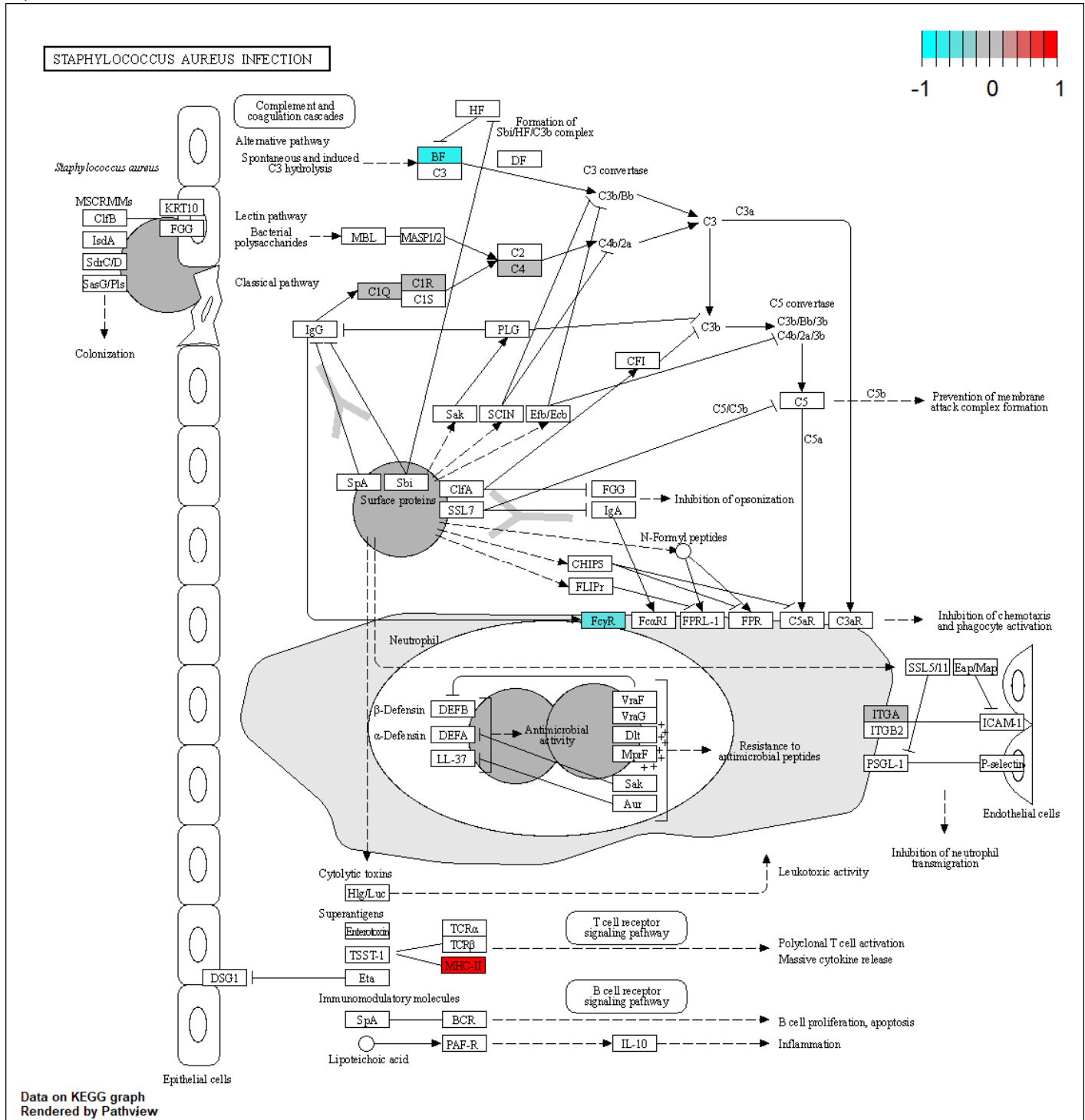




G)

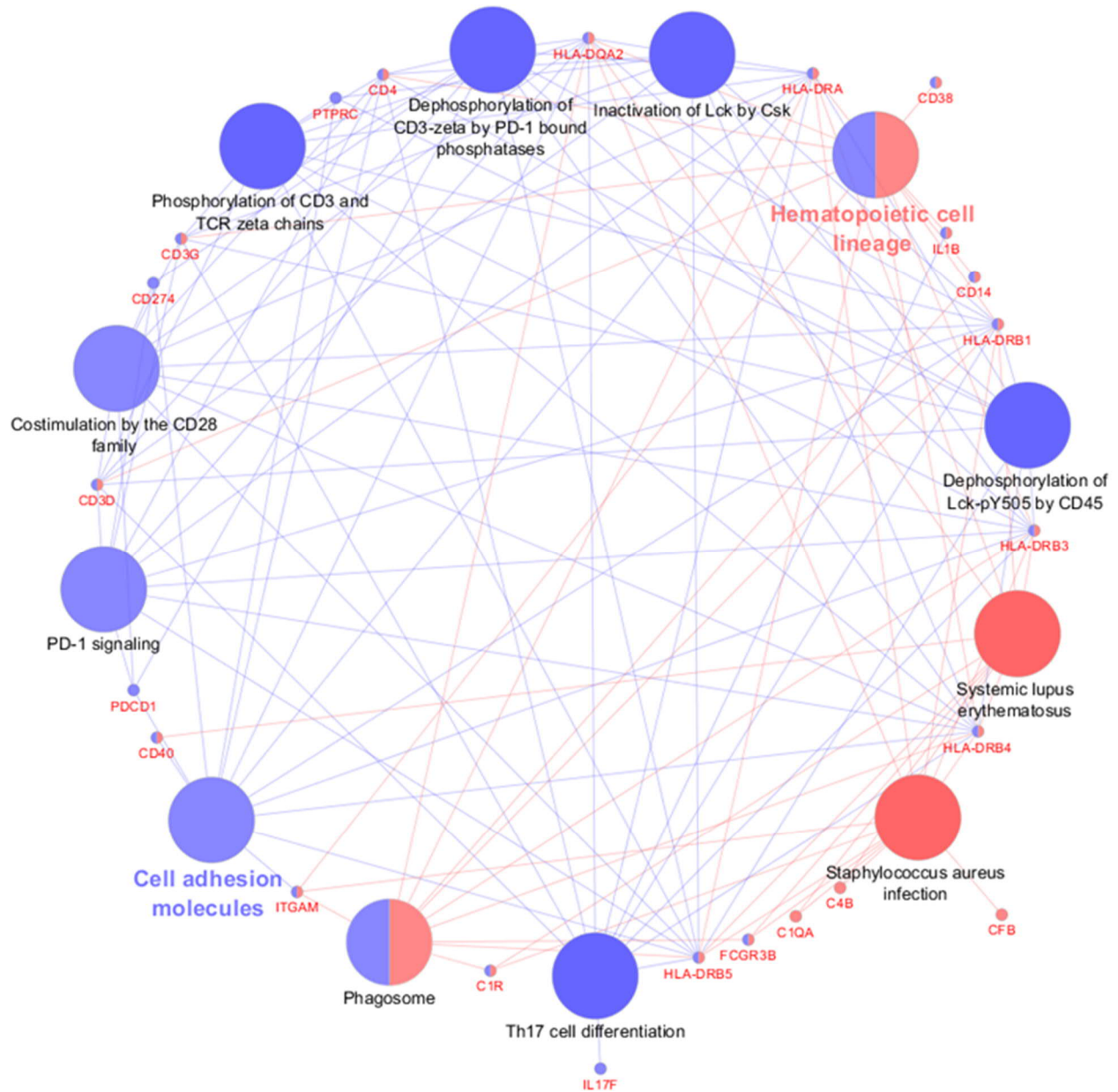


H)



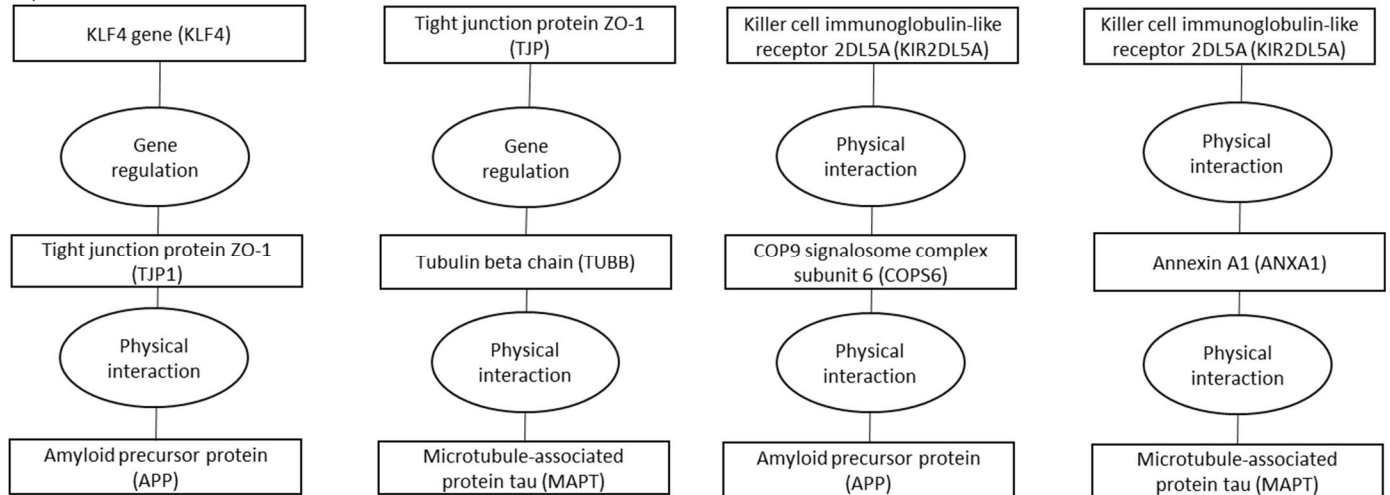


**Supplementary Figure 5.** ClueGO enrichment analyses for all the 76 proteins and receptors in the biomarkers that had evidence of causal association in Mendelian randomization analyses. All proteins that associated with Uniprot search terms “immune system” and “blood brain barrier” were used as a background dataset. GO-terms in blue were enriched in cluster where most significant associations were observed for cell adhesion molecules. In the red cluster, the most significant GO-term associations were observed for hematopoietic cell lineage. Big dots describe the GO-terms and small dots the genes associated with these terms.

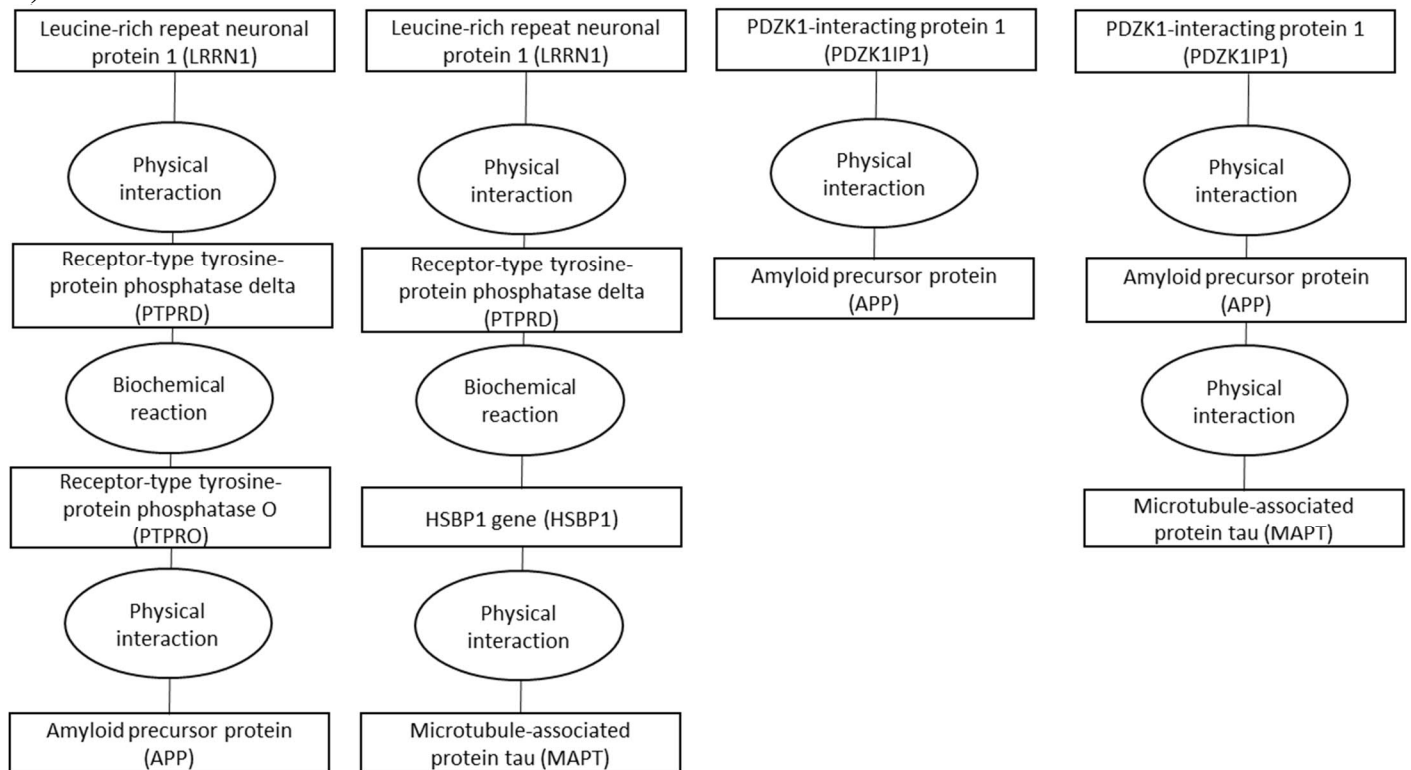


**Supplementary Figures 6A-R.** ConsensusPathDB shortest interaction path analyses for the 42 proteins that were causally associated with dementia causing diseases in Mendelian randomization analyses. Figures A-N include biomarkers for amyloid and tau and O-R for  $\alpha$ -synuclein pathways.

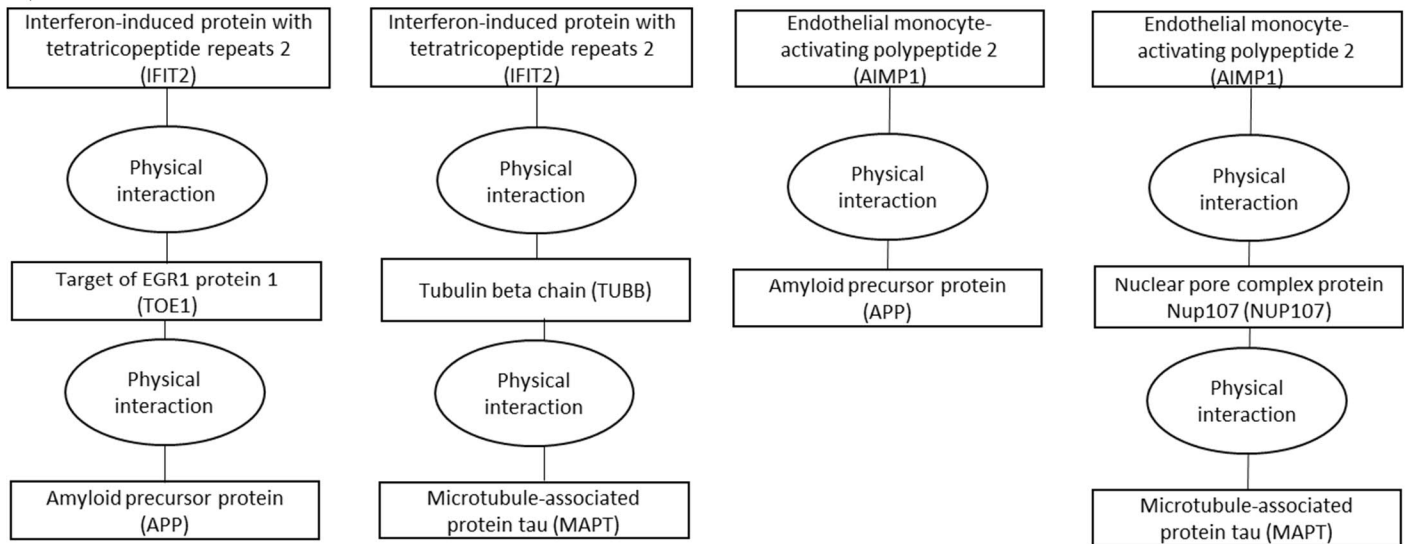
**A)**



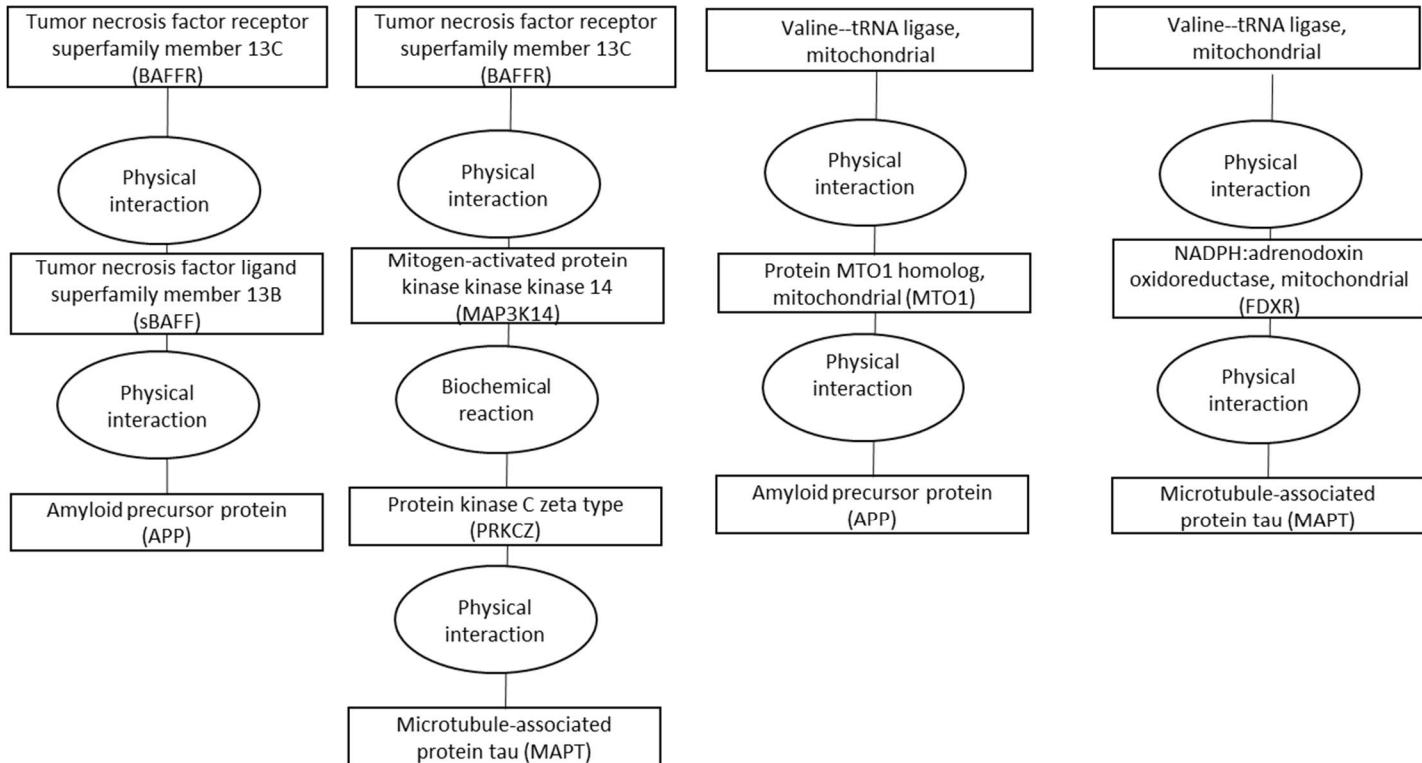
**B)**

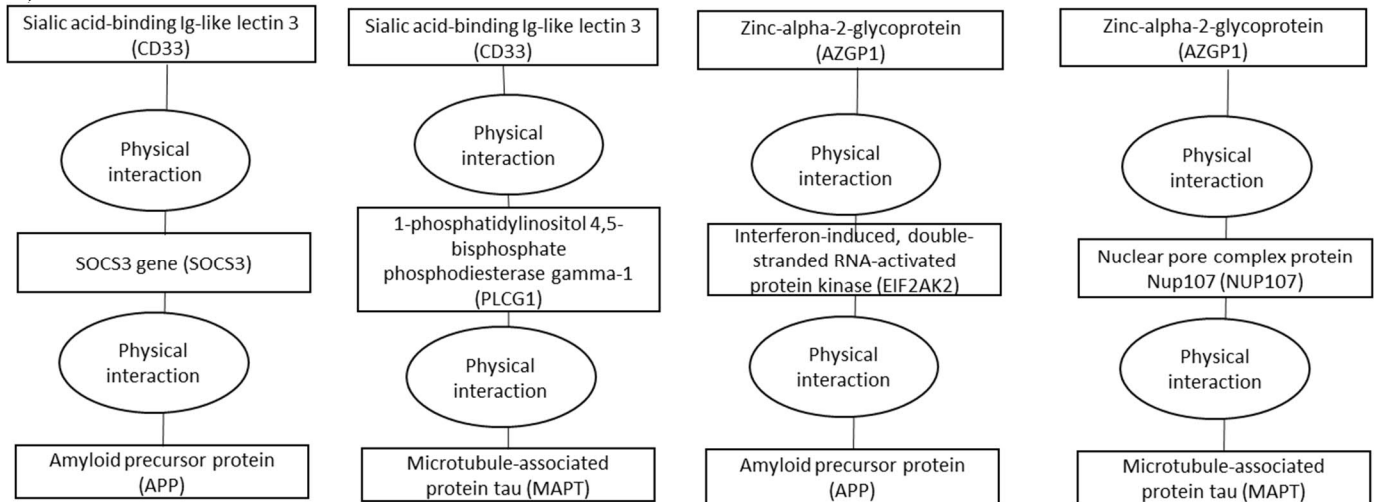
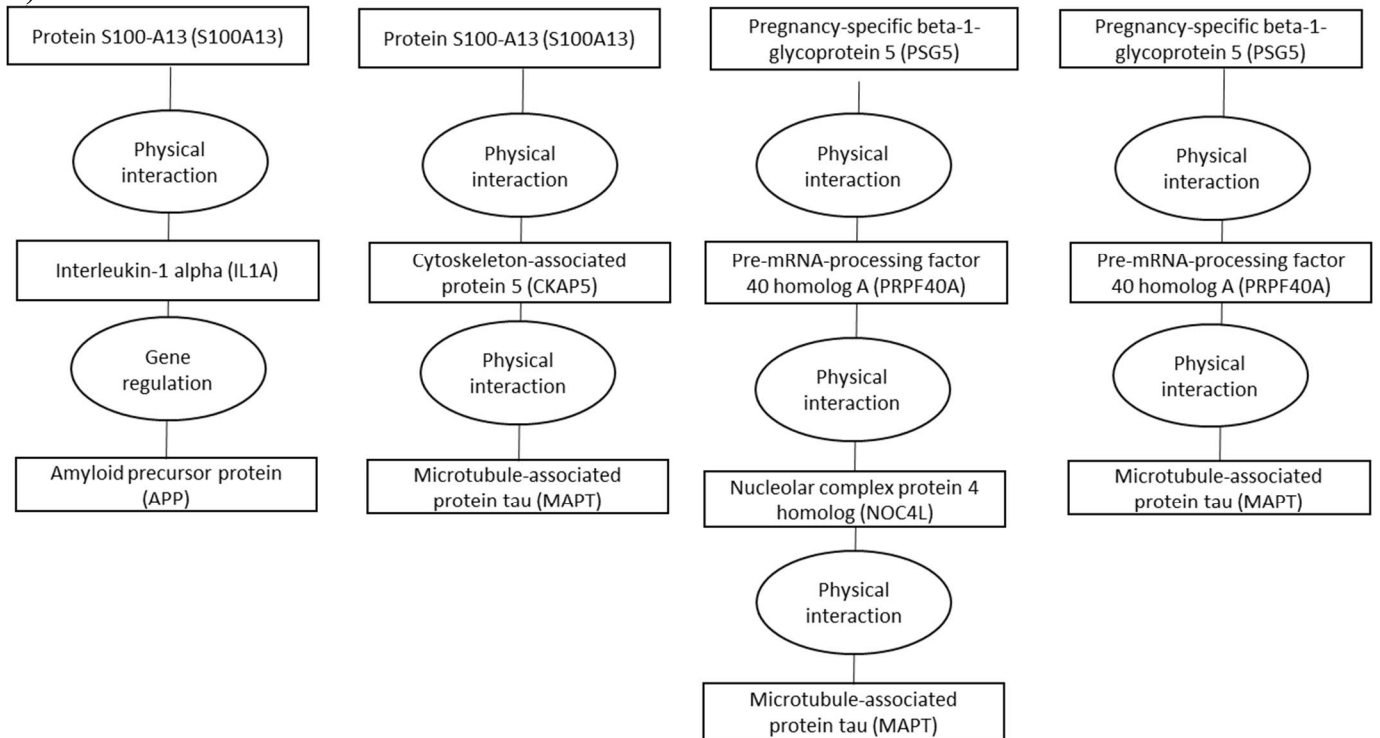


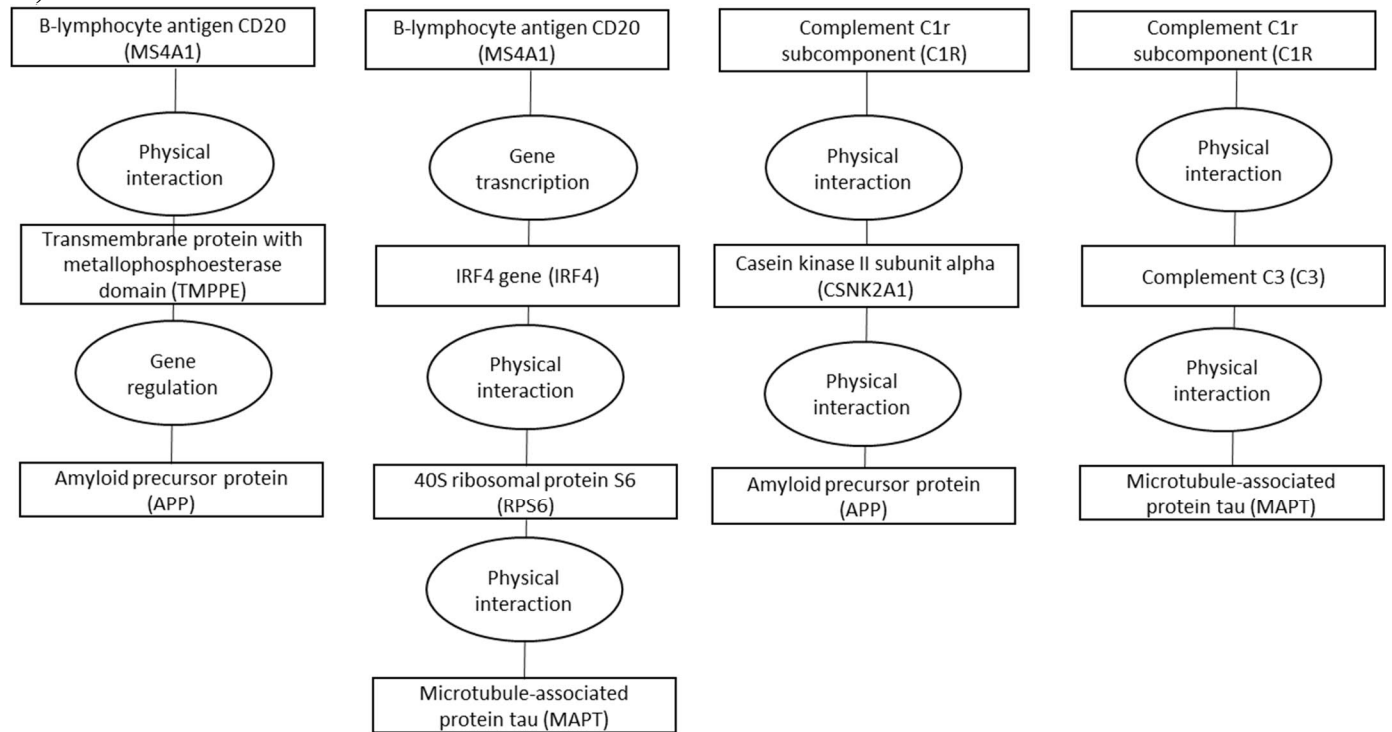
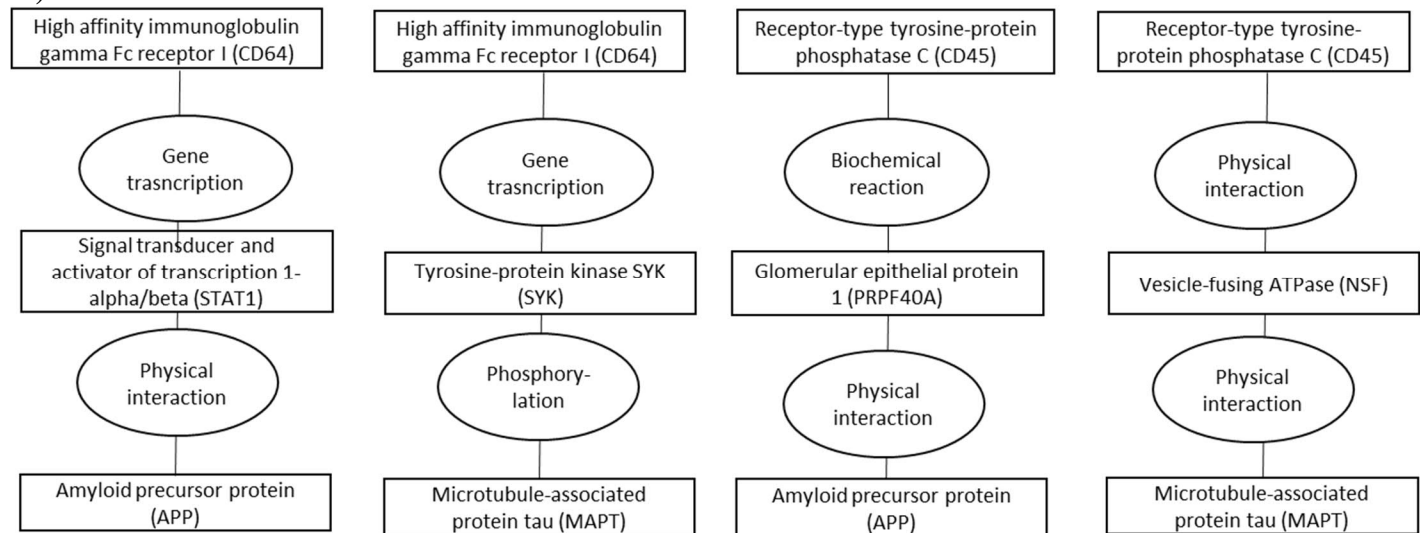
C)

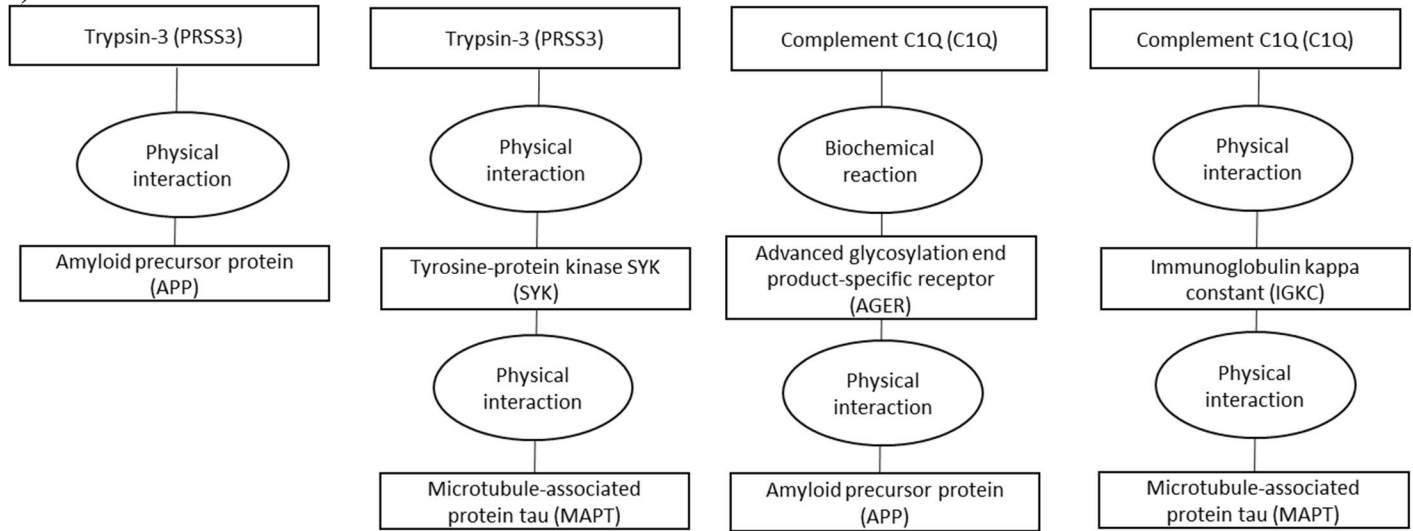
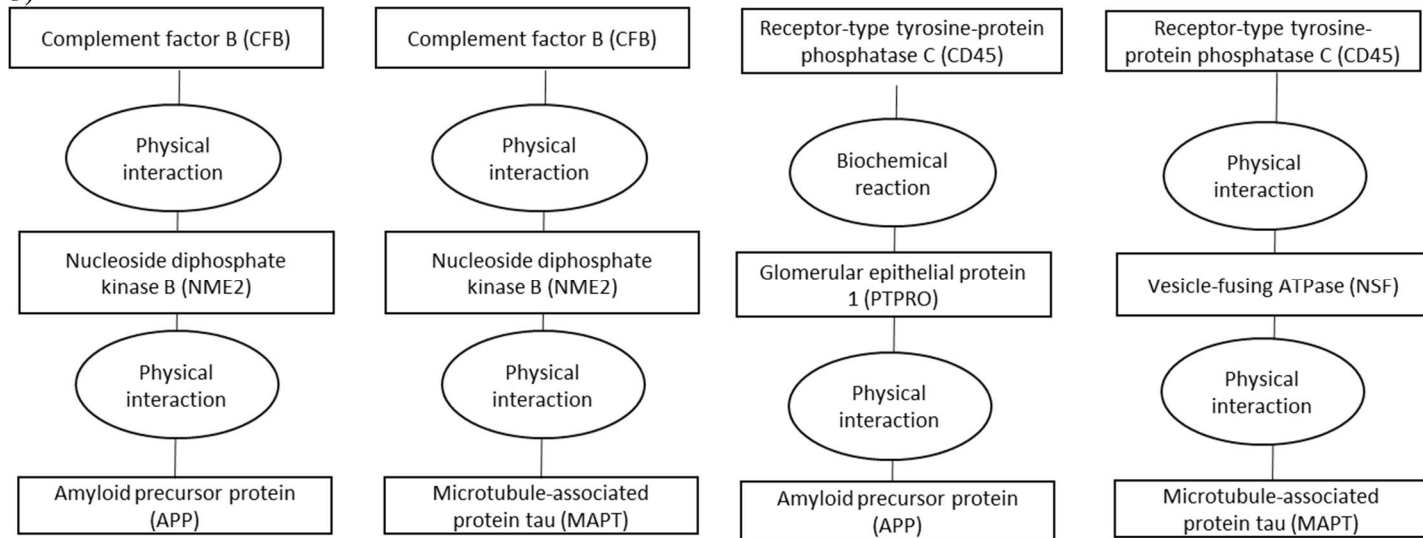


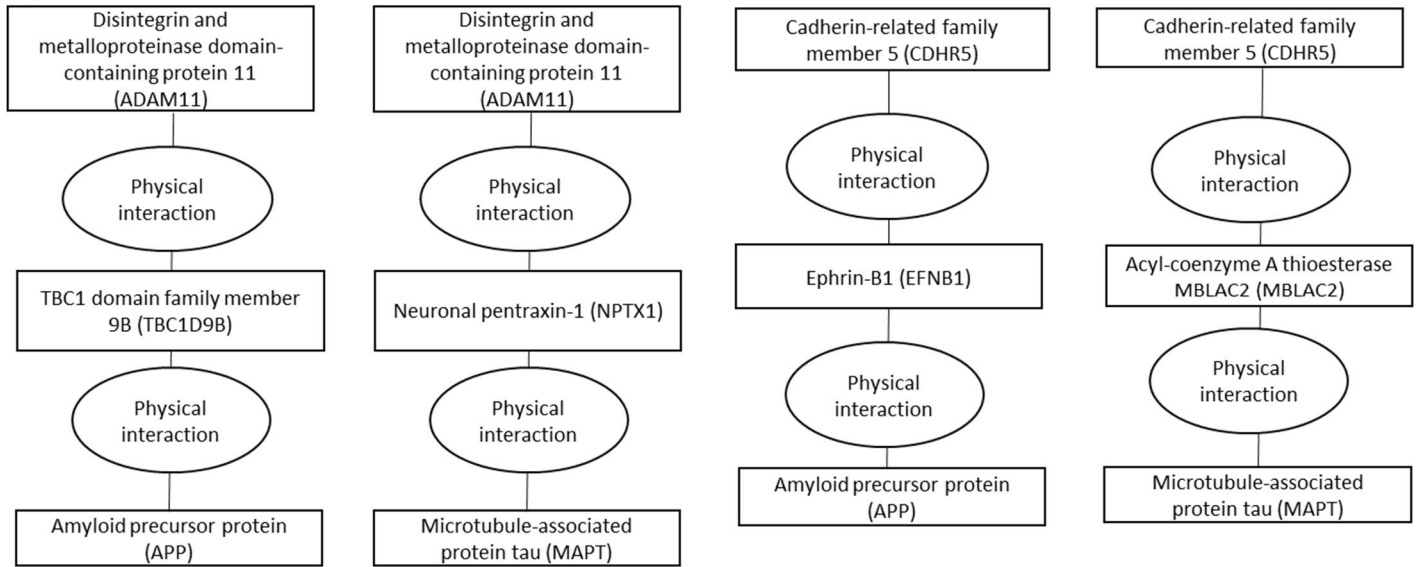
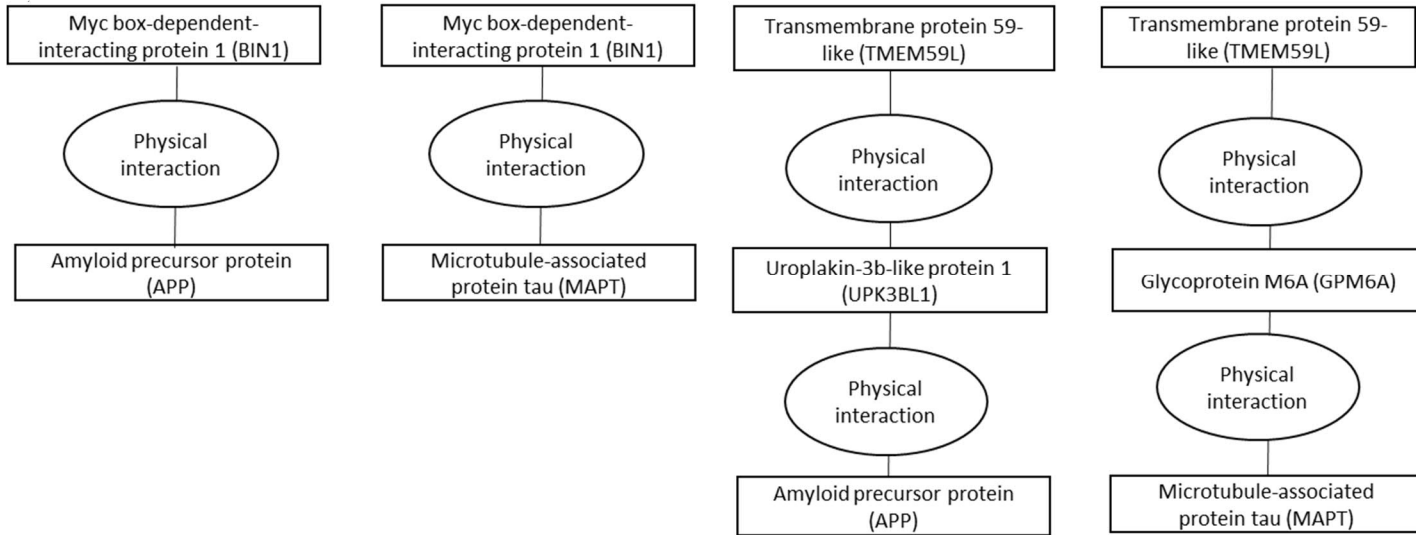
D)



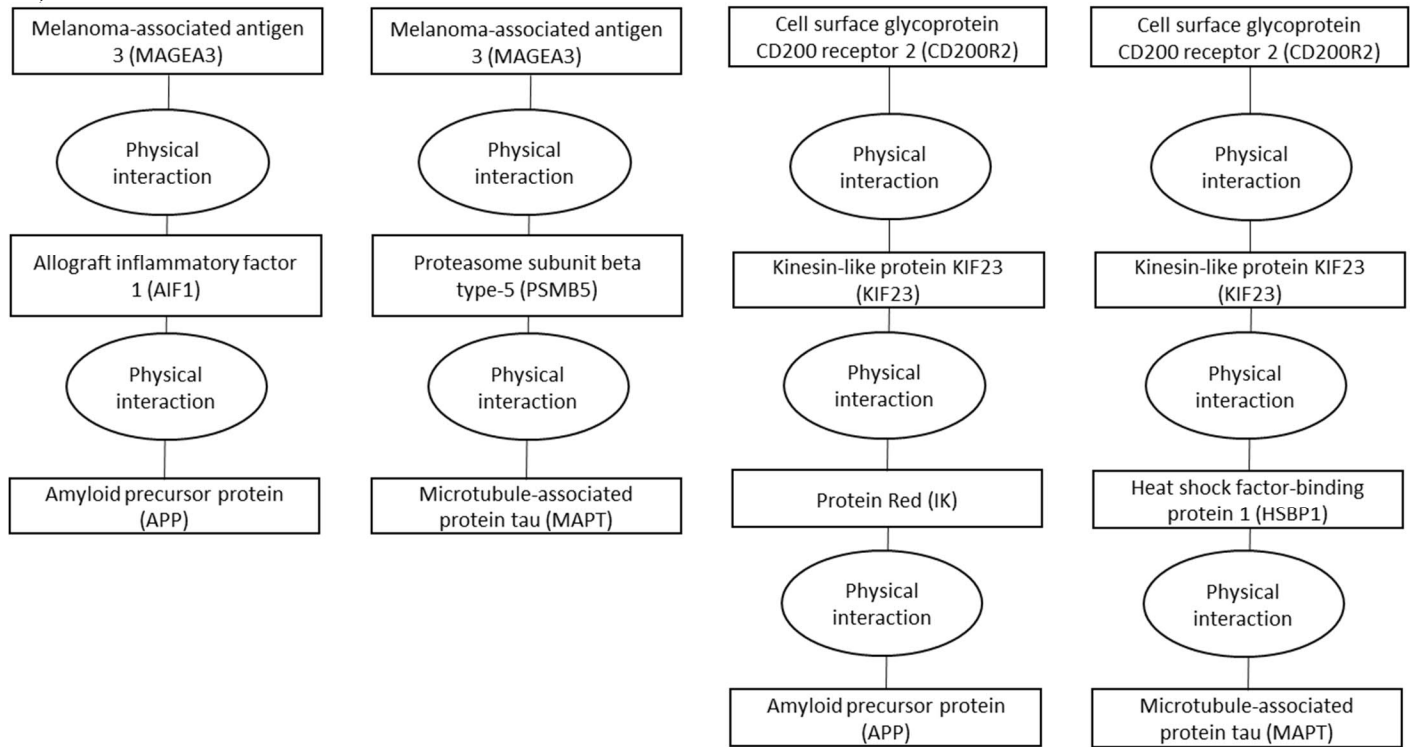
**E)****F)**

**G)****H)**

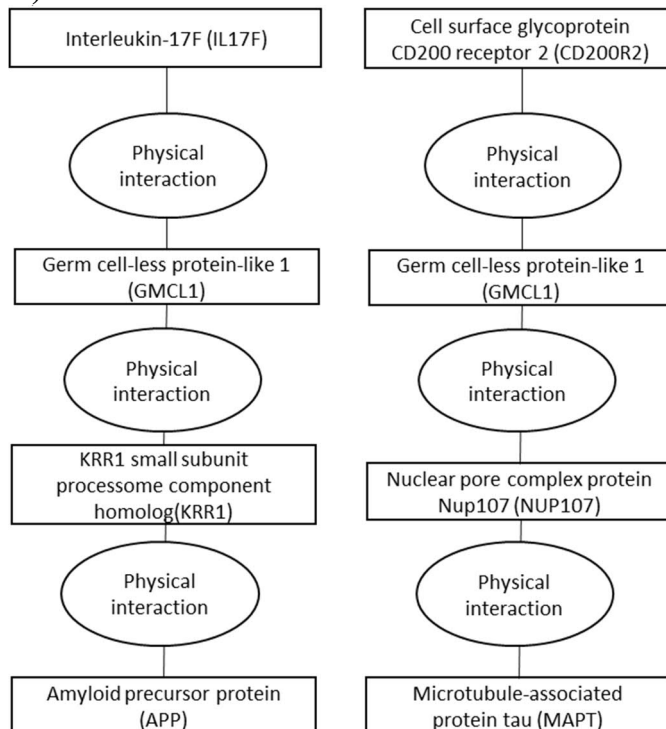
**D)****J)**

**K)****L)**

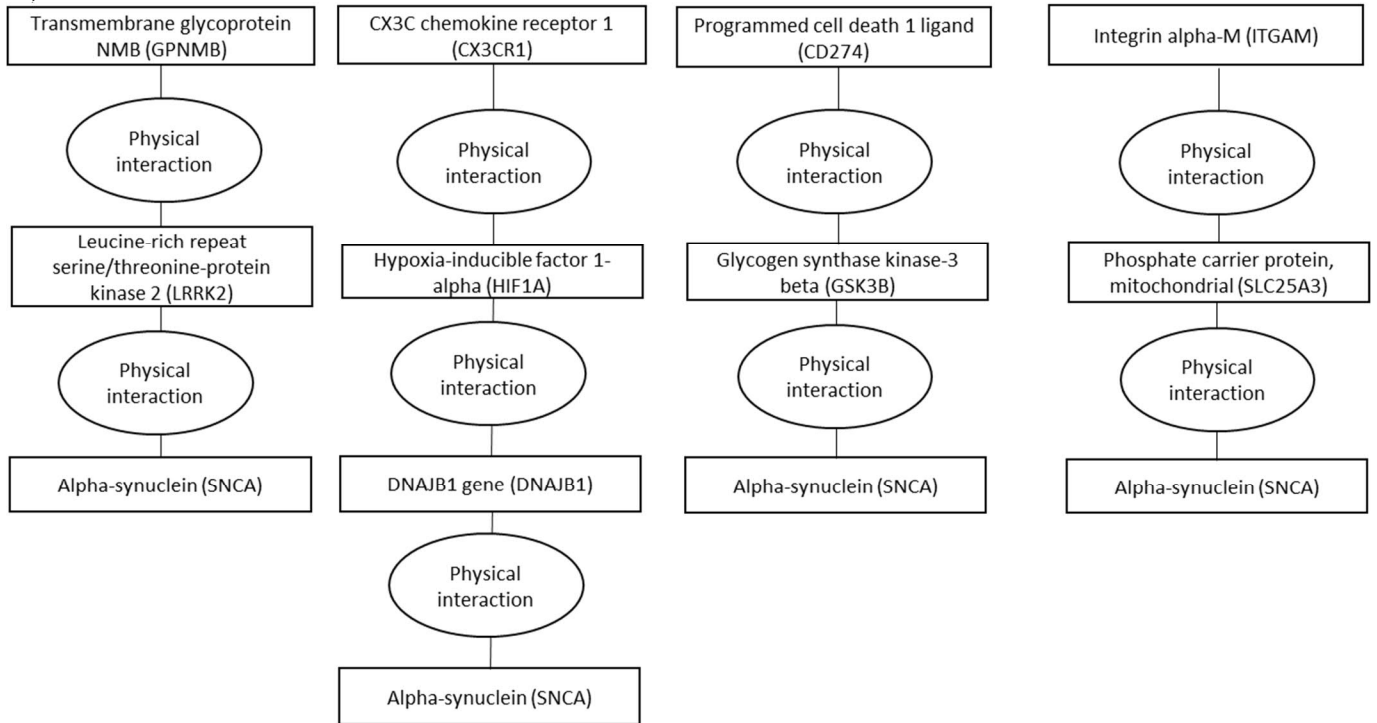
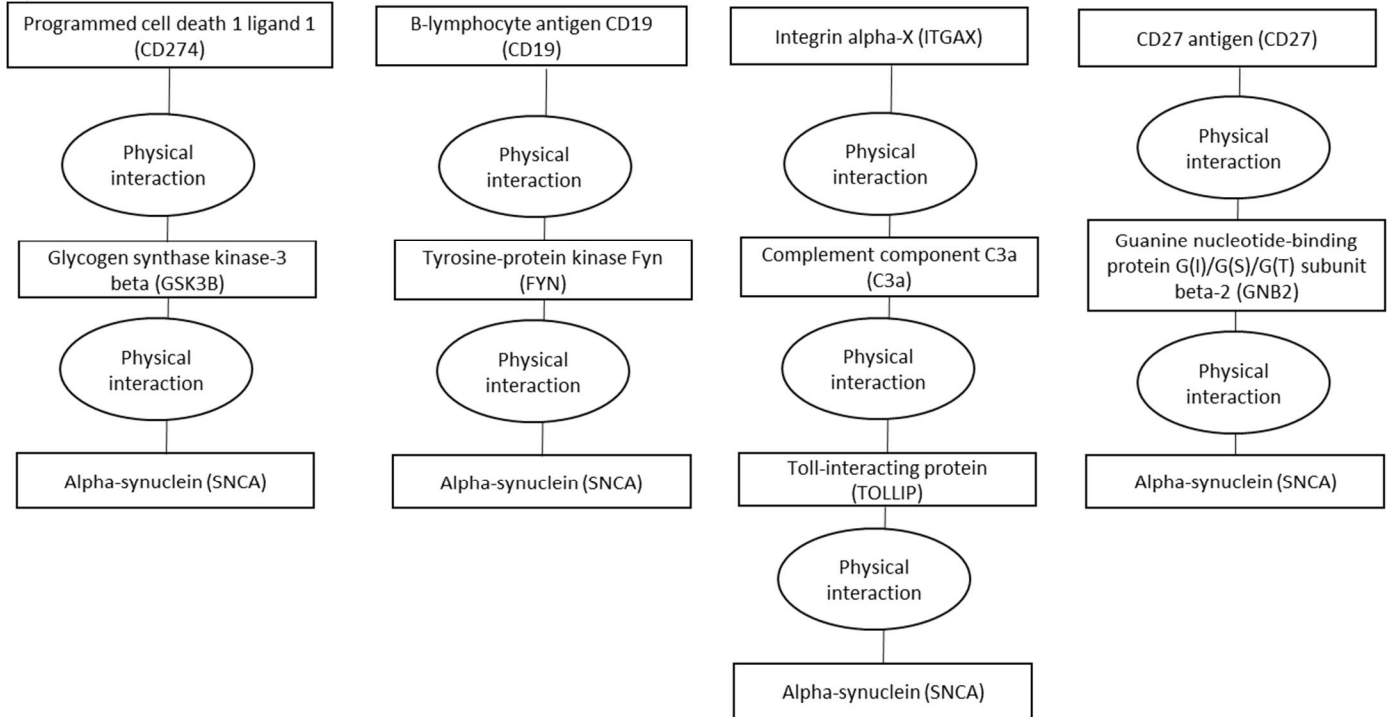
M)

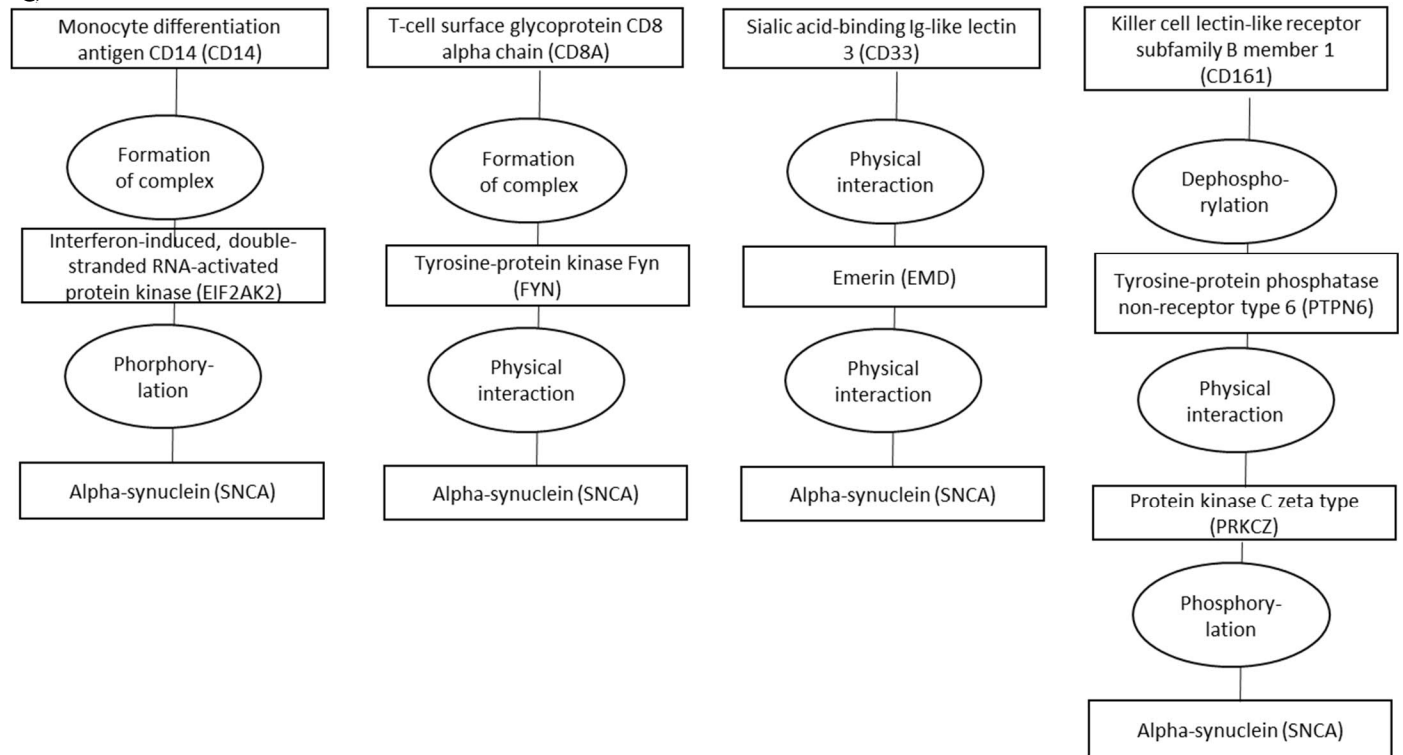
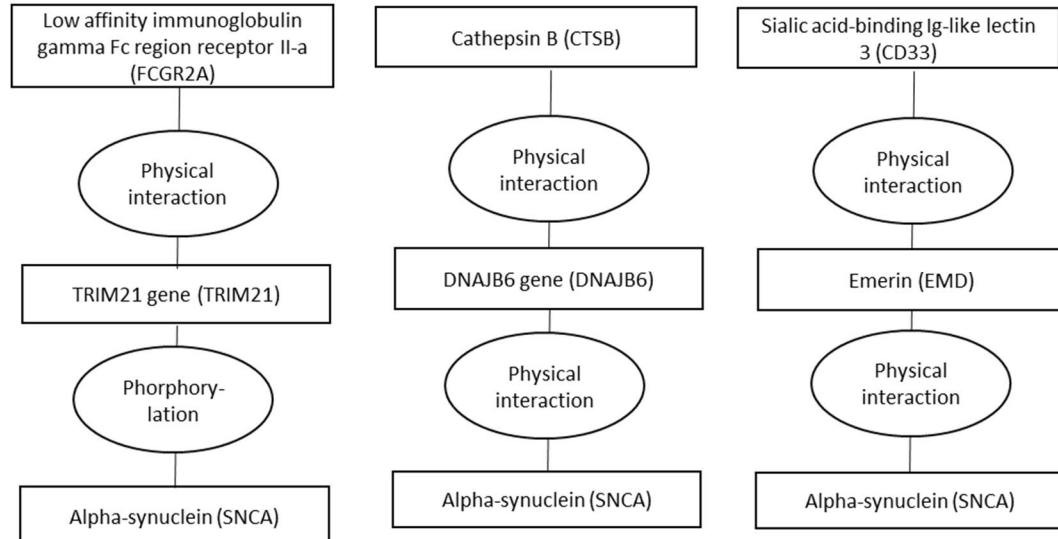


N)





**O)****P)**

**Q)****R)**

## 1 **Supplementary methods**

2

### 3 **Mendelian randomization analyses**

4 The SNPs for biomarkers and outcomes were searched from MR-base database.<sup>1</sup> Immune system  
5 and BBB search terms were identified using identifiers of cell types, receptors, proteins, and genes.  
6 The identifiers were searched from several publications<sup>2-10</sup> and from Uniprot<sup>11</sup> with search terms  
7 “immune” and “blood brain barrier”. Outcomes included all cohorts with following dementia-  
8 causing diseases: all types of Alzheimer’s disease, Parkinson’s disease, vascular dementia,  
9 frontotemporal dementia, dementia in general, and progression of dementia. Poor cognitive  
10 performance was chosen as an intermediate outcome. Two sample Mendelian randomization was  
11 used to analyse associations between biomarkers and outcomes.<sup>12</sup> First analyses estimated effects  
12 with Wald ratio or inverse variance-weighted analyses.<sup>1</sup> For biomarker-outcome pairs that passed  
13 FDR of 5% and shared over two common SNPs we performed sensitivity analyses with weighted  
14 median, simple mode, MR Egger, and backward Mendelian randomization<sup>12</sup> with TwoSampleMR  
15 and MRInstruments R packages.

16 To assess off-target effects of the observed causal biomarkers, we performed a phenome-wide  
17 Mendelian randomization analyses for each biomarker, using GWAS summary statistics for 210  
18 UK Biobank endpoints conducted by Neale lab and with recognized dementia risk factors.<sup>5,13</sup> All  
19 analyses used European ancestry as reference, clumping cut-off  $R^2 = 0.01$  and a 10,000kb window.  
20 LD proxies were searched with  $R^2 = 0.6$  and a proxy split size of 500. The biomarkers and outcome  
21 alleles were harmonized by inferring from positive strand alleles using allele frequencies for  
22 palindromes. We used statistical software R (3.6.0 and 4.1.0) for these analyses. Novelty of our  
23 Mendelian randomization findings was evaluated with Pubmed search using following search  
24 terms: (Mendelian randomization) AND (dementia OR Alzhem\* OR Parkin\* OR cognitive  
25 decline) AND (Entrez gene symbol OR Uniprot protein identifier) without limitations.

26

### 27 **Plasma proteins and Whitehall II study**

28 Plasma protein measurements in Whitehall II study were available for 6,235 individuals of whom  
29 310 developed dementia. The participants are linked to the National Health Services (NHS)  
30 Hospital Episode Statistics (HES) database, and the British National mortality register using  
31 individual NHS identification numbers for linkage.<sup>14</sup> The NHS provides nearly complete health care  
32 coverage for all individuals legally resident in the UK. Incident dementia was defined using the  
33 WHO International Classification of Diseases, version 10 (ICD-10) codes F00, F01, F03, G30, and  
34 G31 and ICD-9 codes 290.0-290.4, 331.0-331.2, 331.82, and 331.9. We also conducted informant  
35 interviews and checked participants’ medications at each screening (in 1996-1998, 2011-2013 and  
36 2016-2017) for dementia-related medication. Sensitivity and specificity of dementia assessment  
37 based on HES data is 0.78 and 0.92.<sup>15</sup>

38 The plasma proteins were measured using the SomaScan version 4.0 and 4.1 assays.<sup>4,16,17</sup> The  
39 assays were validated against external reference population and protein-specific conversion  
40 coefficients were used to balance the technical differences between versions 4.0 and 4.1. The

41 analyses used plasma samples measured in 1995/1997 and stored in 0.25 mL aliquots at  $-80^{\circ}\text{C}$ .  
42 Earlier studies describe performance of the SomaScan assay and the modified aptamer binding in  
43 detail.<sup>4,16,17</sup> In brief, the assay uses a mix of thousands of slow off-rate modified aptamers  
44 (SOMAmers) that bind to proteins in participants' plasma samples where the specificity is ensured  
45 with two-step process analogous to a conventional immunoassay. The specificity of the aptamer  
46 reagents is good and has been tested in several ways.<sup>4,18,19</sup> Median intra- and inter-assay coefficients  
47 of variation for SomaScan version 4 are  $\sim 5\%$  and assay sensitivity is comparable to that of typical  
48 immunoassays, with a median lower limit of detection in the femtomolar range.

49

50 In the Whitehall II study, standard self-administered questionnaires provided data on age and sex.  
51 Using DNA extracted from whole blood, a standard PCR assay determined *APOE* genotype using  
52 the salting out method.<sup>20,21</sup> Two blinded independent observers read the genotype and any  
53 discrepancies were resolved by repeating the PCR analysis.

54 In analyses, proteins were transformed to a normal distribution by inverse rank-based normal  
55 transformation. The follow-up ended at onset of dementia, death, or 1<sup>st</sup> of October 2019, which ever  
56 occurred first. Age, sex, and *APOE* adjusted Cox regression models estimated associations between  
57 the proteins and dementia.<sup>22</sup> The proportionality assumption in all Cox models was assessed with  
58 Schoenfeld residuals and with log-log plots.<sup>22</sup> We used statistical software R (3.6.0 and 4.1.0) for  
59 these analyses.

60

## 61 **Polygenic risk score and IPW analyses**

62 FinnGen Data Freeze 8 contains 339,233 individuals, and represents approximately 7% of Finnish  
63 adult population. FinnGen is a collection of prospective epidemiological and disease-based cohorts,  
64 and hospital biobank samples and links genotypes by the unique national personal identification  
65 numbers to nationwide health registries, including the national hospital discharge (available from  
66 1968), death (1969–), cancer (1953–) and medication reimbursement (1964–) and purchase (1995–)  
67 registries. The registry-based follow-up ended on Dec 31, 2019. Alzheimer's disease was defined  
68 with ICD-10 codes under F00 and G30, ICD-9 codes under 3310, ICD-8 code under 29010, and  
69 medication purchase code N06D. Vascular dementia was defined with ICD-10 codes under F01 and  
70 ICD-9 codes under 4378. Parkinson's disease was defined with ICD-10 codes under G20, ICD-9  
71 codes under 3320A, ICD-8 code under 34200, and reimbursements code 110.

72

73 FinnGen samples were genotyped with Illumina and Affymetrix arrays (Illumina Inc., San Diego,  
74 and Thermo Fisher Scientific, Santa Clara, CA, USA), and genotype calls were made with the  
75 GenCall or zCall (for Illumina) and the AxiomGT1 algorithm for Affymetrix data. Individuals with  
76 ambiguous gender, high genotype missingness ( $>5\%$ ), excess heterozygosity ( $+4\text{SD}$ ) and non-  
77 Finnish ancestry were excluded, as well as all variants with high missingness ( $>2\%$ ), low Hardy-  
78 Weinberg equilibrium p-value ( $<1\text{e-}6$ ) and minor allele count ( $\text{MAC} < 3$ ). Array data pre-phasing  
79 was carried out with Eagle 2.3.5<sup>23</sup> with the number of conditioning haplotypes set to 20,000.  
80 Genotype imputation was done using the population-specific SISu v3 imputation reference with

81 3,775 high-coverage (25-30x) whole-genome sequences in Finns, described in detail at  
82 <https://doi.org/10.17504/protocols.io.xbgfijw>.

83

84 The PRS were constructed from SNPs that were associated with the Mendelian randomization  
85 causal 126 biomarkers for dementias. The SNPs were LD-pruned with clumping cut-off  $R^2 = 0.01$   
86 in 500kb window with R package TwoSampleMR. The available SNPs were searched from  
87 FinnGen genotypes and the final scores were generated with PLINK v2.00aLM3 by calculating the  
88 SNP-biomarker beta weighted sum of risk alleles for each SNP. The PRS was scaled to zero mean  
89 and unit variance, and we analysed its phenome-wide associations across 2401 disease endpoints.  
90 The association between PRS and endpoints were studied with logistic regression, adjusting for  
91 birth year, sex, and ten first principal components of ancestry.

92

93 We used IPW analyses to emulate randomized control trials on the effect of preventive anti-  
94 inflammatory medication on risk of dementias in FinnGen.<sup>24</sup> These analyses included participants  
95 aged over 45 without any dementia-causing disease at baseline (N = 90,512) ATC codes for anti-  
96 inflammatory medication use were searched from medication purchase registry that starts from  
97 1995. To simulate trial design and to avoid immortal time bias, each analyses included only new  
98 medication users. In IPW analyses, we assumed that when medication is initiated, it is continued  
99 until end of follow-up to simulate intention to treat analyses and thus to provide conservative  
100 estimates. The baseline variables in IPW analyses were birth year, sex, ten principal components of  
101 ancestry and time-varying variables statin, ACE-blocker, AT-blocker, renin-blocker, calcium  
102 channel blocker, any diuretic, insulin, metformin, other diabetes drug, depression medication,  
103 antipsychotic, and anticoagulant use as well as time varying any cancer, myocardial infarction,  
104 atrial fibrillation, heart failure, venous thromboembolism, ischemic stroke, intracerebral  
105 haemorrhage, subarachnoid haemorrhage, obesity, sleep apnoea, and chronic obstructive pulmonary  
106 diseases, with informative censoring included. The positive control analyses on statin medication  
107 used these same variables but did not include statin as time-varying covariate. We used R (4.1.2) for  
108 these analyses.

109

### 110 **HLA analyses**

111 The analyses were done using imputed HLA alleles, imputed with high accuracy using a Finnish-  
112 specific reference panel, which has been previously described in detail.<sup>25</sup> After filtering based on a  
113 HLA carrier frequency of  $\geq 0.01$  and posterior probability of  $\geq 0.6$ , we assessed the association  
114 between HLA alleles and dementias and autoimmune diseases using logistic regression, adjusting  
115 for birth year, sex, and ten first principal components of ancestry.

116

### 117 **Pathway analyses**

118 KEGG pathway analysis was used for studying the effect of the biomarkers on validated pathways  
119 with Generally Applicable Gene-set Enrichment (GAGE),<sup>26</sup> using Mendelian randomization Wald

120 ratios or inverse variance weight betas and p-values as input for expression ratios. GO term  
121 enrichment analyses were done with ClueGO version 2.5.8<sup>27</sup> in Cytoscape version 3.7.2.<sup>28</sup> The  
122 hypergeometric test used all the 76 plasma proteins or surface receptors of the 126 biomarkers as  
123 input and all immune system and BBB related proteins from Uniprot<sup>11</sup> as background, with  
124 correction for 5% FDR. The shortest interaction path analyses were done with ConsensusPathDB,<sup>29</sup>  
125 a web based analysis tool containing a range of biomedical databases. ConsensusPathDB was used  
126 to decipher the potential common pathways between the biomarkers and amyloid  $\beta$ , tau protein, and  
127  $\alpha$ -synuclein.

128

### 129 **Open Targets analyses**

130 Medications that change the levels of the 126 biomarkers were searched from Open Targets  
131 database using Uniprot protein and Entrez gene symbols.

132

133

134

135

136

137

138

139

140

141

142

143

144

145

146

147

148

149

150

151

152

## 153 Supplementary references

154

- 155 1. Hemani, G., *et al.* The MR-Base platform supports systematic causal inference across the  
156 human phenome. *Elife* **7**(2018).
- 157 2. Akiyama, H., *et al.* Inflammation and Alzheimer's disease. *Neurobiology of aging* **21**, 383-  
158 421 (2000).
- 159 3. Dendrou, C.A., Petersen, J., Rossjohn, J. & Fugger, L. HLA variation and disease. *Nat Rev*  
160 *Immunol* **18**, 325-339 (2018).
- 161 4. Lindbohm, J.V., *et al.* Plasma proteins, cognitive decline, and 20-year risk of dementia in  
162 the Whitehall II and Atherosclerosis Risk in Communities studies. *Alzheimer's & dementia :*  
163 *the journal of the Alzheimer's Association* (2021).
- 164 5. Livingston, G., *et al.* Dementia prevention, intervention, and care: 2020 report of the Lancet  
165 Commission. *Lancet (London, England)* **396**, 413-446 (2020).
- 166 6. O'Brien, J.T. & Thomas, A. Vascular dementia. *Lancet (London, England)* **386**, 1698-1706  
167 (2015).
- 168 7. Sweeney, M.D., Zhao, Z., Montagne, A., Nelson, A.R. & Zlokovic, B.V. Blood-Brain  
169 Barrier: From Physiology to Disease and Back. *Physiological Reviews* **99**, 21-78 (2019).
- 170 8. Tan, E.K., *et al.* Parkinson disease and the immune system - associations, mechanisms and  
171 therapeutics. *Nat Rev Neurol* **16**, 303-318 (2020).
- 172 9. Theofilopoulos, A.N., Kono, D.H. & Baccala, R. The multiple pathways to autoimmunity.  
173 *Nat Immunol* **18**, 716-724 (2017).
- 174 10. Walker, K.A., *et al.* Large-scale plasma proteomic analysis identifies proteins and pathways  
175 associated with dementia risk. *Nature Aging* **1**, 473-489 (2021).
- 176 11. UniProt, C. UniProt: a worldwide hub of protein knowledge. *Nucleic acids research* **47**,  
177 D506-D515 (2019).
- 178 12. Holmes, M.V., Richardson, T.G., Ference, B.A., Davies, N.M. & Davey Smith, G.  
179 Integrating genomics with biomarkers and therapeutic targets to invigorate cardiovascular  
180 drug development. *Nat Rev Cardiol* **18**, 435-453 (2021).
- 181 13. <http://www.nealelab.is/uk-biobank/>.
- 182 14. Kivimaki, M., *et al.* Validity of Cardiovascular Disease Event Ascertainment Using Linkage  
183 to UK Hospital Records. *Epidemiology (Cambridge, Mass.)* **28**, 735-739 (2017).
- 184 15. Sommerlad, A., *et al.* Accuracy of general hospital dementia diagnoses in England:  
185 Sensitivity, specificity, and predictors of diagnostic accuracy 2008-2016. *Alzheimer's &*  
186 *dementia : the journal of the Alzheimer's Association* **14**, 933-943 (2018).
- 187 16. Gold, L., *et al.* Aptamer-based multiplexed proteomic technology for biomarker discovery.  
188 *PloS one* **5**, e15004 (2010).
- 189 17. Williams, S.A., *et al.* Plasma protein patterns as comprehensive indicators of health. *Nature*  
190 *medicine* **25**, 1851-1857 (2019).
- 191 18. Emilsson, V., *et al.* Co-regulatory networks of human serum proteins link genetics to  
192 disease. *Science (New York, N.Y.)* **361**, 769-773 (2018).
- 193 19. Tin, A., *et al.* Reproducibility and Variability of Protein Analytes Measured Using a  
194 Multiplexed Modified Aptamer Assay. *The journal of applied laboratory medicine* **4**, 30-39  
195 (2019).
- 196 20. Bolla, M.K., Wood, N. & Humphries, S.E. Rapid determination of apolipoprotein E  
197 genotype using a heteroduplex generator. *Journal of lipid research* **40**, 2340-2345 (1999).
- 198 21. Miller, S.A., Dykes, D.D. & Polesky, H.F. A simple salting out procedure for extracting  
199 DNA from human nucleated cells. *Nucleic acids research* **16**, 1215 (1988).
- 200 22. Cox, D.R. Regression Models and Life-Tables. *Journal of the Royal Statistical*  
201 *Society.Series B (Methodological)* **34**, 187-220 (1972).

- 202 23. Loh, P.R., *et al.* Reference-based phasing using the Haplotype Reference Consortium panel.  
203 *Nat Genet* **48**, 1443-1448 (2016).
- 204 24. Hernán, M.A. & Robins, J.M. Using Big Data to Emulate a Target Trial When a  
205 Randomized Trial Is Not Available. *Am J Epidemiol* **183**, 758-764 (2016).
- 206 25. Ritari, J., Hyvärinen, K., Clancy, J., Partanen, J. & Koskela, S. Increasing accuracy of HLA  
207 imputation by a population-specific reference panel in a FinnGen biobank cohort. *NAR*  
208 *Genom Bioinform* **2**, lqaa030 (2020).
- 209 26. Luo, W., Friedman, M.S., Shedden, K., Hankenson, K.D. & Woolf, P.J. GAGE: generally  
210 applicable gene set enrichment for pathway analysis. *BMC Bioinformatics* **10**, 161 (2009).
- 211 27. Bindea, G., *et al.* ClueGO: a Cytoscape plug-in to decipher functionally grouped gene  
212 ontology and pathway annotation networks. *Bioinformatics* **25**, 1091-1093 (2009).
- 213 28. Shannon, P., *et al.* Cytoscape: a software environment for integrated models of biomolecular  
214 interaction networks. *Genome Res* **13**, 2498-2504 (2003).
- 215 29. Herwig, R., Hardt, C., Lienhard, M. & Kamburov, A. Analyzing and interpreting genome  
216 data at the network level with ConsensusPathDB. *Nature Protocols* **11**, 1889-1907 (2016).
- 217



Supplementary file 1. Distance from *APOE* gene

| SNP        | Beta exposure | Exposure  | Outcome   | Chromosome | Position   | Distance from start of APOE | Distance from end of APOE |
|------------|---------------|---|---|------------|------------|-----------------------------|---------------------------|
| rs12461065 | 0.1574        | Valine--tRNA ligase    id:prot-a-3191                                 | Alzheimer's disease (more excluded)    id:finn-a-AD_EXMORE    | 19         | 45 102 050 | - 306 961                   | - 310 600                 |
| rs395908   | 0.3382        | EMAP-2    id:prot-c-2714_78_2   | Alzheimer's disease    id:ieu-b-2                             | 19         | 45 380 961 | - 28 050                    | - 31 689                  |
| rs429358   | 0.3499        | Killer cell immunoglobulin-like receptor 2DL5A    id:prot-a-1643      | Alzheimer's disease (late onset)    id:ebi-a-GCST002245       | 19         | 45 411 941 | 2 930                       | - 709                     |
| rs429358   | 1.1769        | Leucine-rich repeat neuronal protein 1    id:prot-a-1792              | Alzheimer's disease (late onset)    id:ebi-a-GCST002245       | 19         | 45 411 941 | 2 930                       | - 709                     |
| rs429358   | 0.3527        | PDZK1-interacting protein 1    id:prot-a-2242                         | Alzheimer's disease (late onset)    id:ebi-a-GCST002245       | 19         | 45 411 941 | 2 930                       | - 709                     |
| rs429358   | 0.2148        | Tight junction protein ZO-1    id:prot-a-2983                         | Alzheimer's disease (late onset)    id:ebi-a-GCST002245       | 19         | 45 411 941 | 2 930                       | - 709                     |
| rs438811   | -1.2435       | Protein S100-A13    id:prot-a-2616                                    | Alzheimer's disease (late onset)    id:ebi-a-GCST002245       | 19         | 45 418 790 | 9 779                       | 6 140                     |
| rs5167     | 0.2454        | BAFF Receptor    id:prot-c-5383_14_3                                  | Alzheimer's disease (late onset)    id:ebi-a-GCST002245       | 19         | 45 448 465 | 39 454                      | 35 815                    |
| rs5167     | 0.3319        | Endothelial monocyte-activating polypeptide 2    id:prot-a-65         | Alzheimer's disease (late onset)    id:ebi-a-GCST002245       | 19         | 45 448 465 | 39 454                      | 35 815                    |
| rs5167     | 0.277         | Melanoma-associated antigen 3    id:prot-a-1828                       | Alzheimer's disease (late onset)    id:ebi-a-GCST002245       | 19         | 45 448 465 | 39 454                      | 35 815                    |
| rs5167     | 0.2145        | Transmembrane protein 59-like    id:prot-a-3014                       | Alzheimer's disease (late onset)    id:ebi-a-GCST002245       | 19         | 45 448 465 | 39 454                      | 35 815                    |
| rs5167     | 0.8678        | Valine--tRNA ligase    id:prot-a-3191                                 | Alzheimer's disease (more excluded)    id:finn-a-AD_EXMORE    | 19         | 44 980 181 | - 428 830                   | - 432 469                 |
| rs59325138 | 0.1436        | Interferon-induced protein with tetratricopeptide repeats 2    id:pro | Alzheimer's disease (late onset)    id:ebi-a-GCST002245       | 19         | 45 416 291 | 7 280                       | 3 641                     |
| rs7412     | -0.4743       | Cadherin-related family member 5    id:prot-a-490                     | Alzheimer's disease (late onset)    id:ebi-a-GCST002245       | 19         | 45 412 079 | 3 068                       | - 571                     |
| rs7412     | 0.7212        | Cell surface glycoprotein CD200 receptor 2    id:prot-a-424           | Alzheimer's disease (late onset)    id:ebi-a-GCST002245       | 19         | 45 412 079 | 3 068                       | - 571                     |
| rs7412     | -0.3721       | Disintegrin and metalloproteinase domain-containing protein 11    ic  | Alzheimer's disease (late onset)    id:ebi-a-GCST002245       | 19         | 45 412 079 | 3 068                       | - 571                     |
| rs7412     | -0.5043       | Pregnancy-specific beta-1-glycoprotein 5    id:prot-a-2404            | Alzheimer disease (more excluded)    id:finn-a-G6_ALZHEIMER_E | 19         | 44 921 921 | - 487 090                   | - 490 729                 |

Supplementary File 2. Drugs available in the Open Targets database that act on the biomarkers that associated with dementias and are hypothesized to reduce the risk. In total 64 different drugs were identified.

| Drug_ID       | Drug_name                 | Type     | Mechanism_of_action   | Action_type   | Disease_ID      | Disease_name_originally_used_for      | Phase | Status                 | Source  |
|---------------|---------------------------|----------|---|---------------|-----------------|---------------------------------------|-------|------------------------|---|
| CHEMBL2107842 | ALBINTERFERON ALFA-2B     | Protein  | Interferon alpha/beta receptor agonist                      | Agonist       | EFO_0003047     | hepatitis C virus infection           | 2     | Completed              | <a href="https://clinicaltrials.gov/search?id=%22NCT00097435%22">https://clinicaltrials.gov/search?id=%22NCT00097435%22</a>   |
| CHEMBL2107842 | ALBINTERFERON ALFA-2B     | Protein  | Interferon alpha/beta receptor agonist                      | Agonist       | EFO_0004220     | chronic hepatitis C virus infection   | 2     | Completed              | <a href="https://clinicaltrials.gov/search?id=%22NCT00759200%22">https://clinicaltrials.gov/search?id=%22NCT00759200%22</a> , <a href="https://clinicaltrials.gov/sea">https://clinicaltrials.gov/sea</a> |
| CHEMBL2107842 | ALBINTERFERON ALFA-2B     | Protein  | Interferon alpha/beta receptor agonist                      | Agonist       | EFO_0004239     | chronic hepatitis B virus infection   | 1     | Terminated             | <a href="https://clinicaltrials.gov/search?id=%22NCT00964665%22">https://clinicaltrials.gov/search?id=%22NCT00964665%22</a>   |
| CHEMBL2108252 | APOLIZUMAB                | Antibody | Human leukocyte antigen DR beta chain inhibitor             | Inhibitor     | EFO_0000095     | chronic lymphocytic leukemia          | 1     | Terminated             | <a href="https://clinicaltrials.gov/search?id=%22NCT00022971%22">https://clinicaltrials.gov/search?id=%22NCT00022971%22</a>   |
| CHEMBL2108252 | APOLIZUMAB                | Antibody | Human leukocyte antigen DR beta chain inhibitor             | Inhibitor     | EFO_0000403     | diffuse large B-cell lymphoma         | 1     | Terminated             | <a href="https://clinicaltrials.gov/search?id=%22NCT00022971%22">https://clinicaltrials.gov/search?id=%22NCT00022971%22</a>   |
| CHEMBL2108252 | APOLIZUMAB                | Antibody | Human leukocyte antigen DR beta chain inhibitor             | Inhibitor     | EFO_0000574     | lymphoma                              | 1     | Completed              | <a href="https://clinicaltrials.gov/search?id=%22NCT00004101%22">https://clinicaltrials.gov/search?id=%22NCT00004101%22</a>   |
| CHEMBL2108252 | APOLIZUMAB                | Antibody | Human leukocyte antigen DR beta chain inhibitor             | Inhibitor     | EFO_1001469     | Mantle cell lymphoma                  | 1     | Terminated             | <a href="https://clinicaltrials.gov/search?id=%22NCT00022971%22">https://clinicaltrials.gov/search?id=%22NCT00022971%22</a>   |
| CHEMBL2108252 | APOLIZUMAB                | Antibody | Human leukocyte antigen DR beta chain inhibitor             | Inhibitor     | MONDO_0018906   | follicular lymphoma                   | 1     | Terminated             | <a href="https://clinicaltrials.gov/search?id=%22NCT00022971%22">https://clinicaltrials.gov/search?id=%22NCT00022971%22</a>   |
| CHEMBL4297888 | APX-005M                  | Unknown  | Tumor necrosis factor receptor superfamily member 5 agonist | Agonist       | EFO_1000657     | rectum cancer                         | 2     | Recruiting             | <a href="https://clinicaltrials.gov/search?id=%22NCT04130854%22">https://clinicaltrials.gov/search?id=%22NCT04130854%22</a>   |
| CHEMBL4297888 | APX-005M                  | Unknown  | Tumor necrosis factor receptor superfamily member 5 agonist | Agonist       | EFO_1001968     | soft tissue sarcoma                   | 2     | Recruiting             | <a href="https://clinicaltrials.gov/search?id=%22NCT03719430%22">https://clinicaltrials.gov/search?id=%22NCT03719430%22</a>   |
| CHEMBL4297888 | APX-005M                  | Unknown  | Tumor necrosis factor receptor superfamily member 5 agonist | Agonist       | MONDO_0007576   | esophageal cancer                     | 2     | Recruiting             | <a href="https://clinicaltrials.gov/search?id=%22NCT03165994%22">https://clinicaltrials.gov/search?id=%22NCT03165994%22</a>   |
| CHEMBL4297888 | APX-005M                  | Unknown  | Tumor necrosis factor receptor superfamily member 5 agonist | Agonist       | EFO_0000756     | melanoma                              | 1     | Recruiting             | <a href="https://clinicaltrials.gov/search?id=%22NCT02706353%22">https://clinicaltrials.gov/search?id=%22NCT02706353%22</a>   |
| CHEMBL4297888 | APX-005M                  | Unknown  | Tumor necrosis factor receptor superfamily member 5 agonist | Agonist       | EFO_0002617     | metastatic melanoma                   | 1     | Terminated             | <a href="https://clinicaltrials.gov/search?id=%22NCT03597282%22">https://clinicaltrials.gov/search?id=%22NCT03597282%22</a>   |
| CHEMBL4297888 | APX-005M                  | Unknown  | Tumor necrosis factor receptor superfamily member 5 agonist | Agonist       | EFO_1000044     | pancreatic adenocarcinoma             | 1     | Active, not recruiting | <a href="https://clinicaltrials.gov/search?id=%22NCT03214250%22">https://clinicaltrials.gov/search?id=%22NCT03214250%22</a>   |
| CHEMBL2109266 | AVE-9633                  | Antibody | Myeloid cell surface antigen CD33 binding agent             | Binding agent | MONDO_0004643   | myeloid leukemia                      | 1     | Terminated             | <a href="https://clinicaltrials.gov/search?id=%22NCT00543972%22">https://clinicaltrials.gov/search?id=%22NCT00543972%22</a>   |
| CHEMBL3989989 | AXICABTAGENE CILOLEUCEL   | Gene     | B-lymphocyte antigen CD19 binding agent                     | Binding agent | EFO_0000616     | neoplasm                              | 3     |                        | <a href="http://www.whocc.no/atc_ddd_index/?code=L01XX70">http://www.whocc.no/atc_ddd_index/?code=L01XX70</a>   |
| CHEMBL3989989 | AXICABTAGENE CILOLEUCEL   | Gene     | B-lymphocyte antigen CD19 binding agent                     | Binding agent | EFO_0011057     | neurotoxicity                         | 2     | Recruiting             | <a href="https://clinicaltrials.gov/search?id=%22NCT04150913%22">https://clinicaltrials.gov/search?id=%22NCT04150913%22</a>   |
| CHEMBL3989989 | AXICABTAGENE CILOLEUCEL   | Gene     | B-lymphocyte antigen CD19 binding agent                     | Binding agent | EFO_1001469     | Mantle cell lymphoma                  | 2     | Active, not recruiting | <a href="https://clinicaltrials.gov/search?id=%22NCT02601313%22">https://clinicaltrials.gov/search?id=%22NCT02601313%22</a>   |
| CHEMBL3989989 | AXICABTAGENE CILOLEUCEL   | Gene     | B-lymphocyte antigen CD19 binding agent                     | Binding agent | EFO_0000096     | neoplasm of mature B-cells            | 1     | Active, not recruiting | <a href="https://clinicaltrials.gov/search?id=%22NCT04314843%22">https://clinicaltrials.gov/search?id=%22NCT04314843%22</a> , <a href="https://clinicaltrials.gov/sea">https://clinicaltrials.gov/sea</a> |
| CHEMBL3989989 | AXICABTAGENE CILOLEUCEL   | Gene     | B-lymphocyte antigen CD19 binding agent                     | Binding agent | EFO_0000403     | diffuse large B-cell lymphoma         | 1     | Active, not recruiting | <a href="https://clinicaltrials.gov/search?id=%22NCT02926833%22">https://clinicaltrials.gov/search?id=%22NCT02926833%22</a>   |
| CHEMBL3989989 | AXICABTAGENE CILOLEUCEL   | Gene     | B-lymphocyte antigen CD19 binding agent                     | Binding agent | EFO_0000574     | lymphoma                              | 1     | Recruiting             | <a href="https://clinicaltrials.gov/search?id=%22NCT04608487%22">https://clinicaltrials.gov/search?id=%22NCT04608487%22</a>   |
| CHEMBL3989989 | AXICABTAGENE CILOLEUCEL   | Gene     | B-lymphocyte antigen CD19 binding agent                     | Binding agent | MONDO_0018906   | follicular lymphoma                   | 1     | Active, not recruiting | <a href="https://clinicaltrials.gov/search?id=%22NCT02348216%22">https://clinicaltrials.gov/search?id=%22NCT02348216%22</a>   |
| CHEMBL3989989 | AXICABTAGENE CILOLEUCEL   | Gene     | B-lymphocyte antigen CD19 binding agent                     | Binding agent | MONDO_0044889   | high grade B-cell lymphoma            | 1     | Active, not recruiting | <a href="https://clinicaltrials.gov/search?id=%22NCT02348216%22">https://clinicaltrials.gov/search?id=%22NCT02348216%22</a>   |
| CHEMBL4594618 | BREXUCABTAGENE AUTOLEUCEL | Gene     | B-lymphocyte antigen CD19 binding agent                     | Binding agent | EFO_1001469     | Mantle cell lymphoma                  | 2     | Active, not recruiting | <a href="https://clinicaltrials.gov/search?id=%22NCT02601313%22">https://clinicaltrials.gov/search?id=%22NCT02601313%22</a>   |
| CHEMBL4594618 | BREXUCABTAGENE AUTOLEUCEL | Gene     | B-lymphocyte antigen CD19 binding agent                     | Binding agent | EFO_0000095     | chronic lymphocytic leukemia          | 1     | Active, not recruiting | <a href="https://clinicaltrials.gov/search?id=%22NCT03624036%22">https://clinicaltrials.gov/search?id=%22NCT03624036%22</a>   |
| CHEMBL4594618 | BREXUCABTAGENE AUTOLEUCEL | Gene     | B-lymphocyte antigen CD19 binding agent                     | Binding agent | EFO_0000220     | acute lymphoblastic leukemia          | 1     | Active, not recruiting | <a href="https://clinicaltrials.gov/search?id=%22NCT02614066%22">https://clinicaltrials.gov/search?id=%22NCT02614066%22</a>   |
| CHEMBL1201834 | CANAKINUMAB               | Antibody | Interleukin-1 beta inhibitor                                | Inhibitor     | EFO_0000540     | immune system disease                 | 4     |                        | <a href="http://www.whocc.no/atc_ddd_index/?code=L04AC08">http://www.whocc.no/atc_ddd_index/?code=L04AC08</a>   |
| CHEMBL1201834 | CANAKINUMAB               | Antibody | Interleukin-1 beta inhibitor                                | Inhibitor     | Orphanet_208650 | Cryopyrin-associated periodic syndron | 4     |                        | <a href="http://dailymed.nlm.nih.gov/dailymed/drugInfo.cfm?setid=7d271f3b-e4f9-4d80-8dcf-">http://dailymed.nlm.nih.gov/dailymed/drugInfo.cfm?setid=7d271f3b-e4f9-4d80-8dcf-</a>                           |
| CHEMBL1201834 | CANAKINUMAB               | Antibody | Interleukin-1 beta inhibitor                                | Inhibitor     | EFO_0003106     | pneumonia                             | 3     | Completed              | <a href="https://clinicaltrials.gov/search?id=%22NCT04362813%22">https://clinicaltrials.gov/search?id=%22NCT04362813%22</a>   |

|               |             |          |                              |           |                 |  |                          |   |
|---------------|-------------|----------|------------------------------|-----------|-----------------|--|--------------------------|---|
| CHEMBL1201834 | CANAKINUMAB | Antibody | Interleukin-1 beta inhibitor | Inhibitor | EFO_0003914     | atherosclerosis                        | 3 Completed              | <a href="https://clinicaltrials.gov/search?id=%22NCT01327846%22">https://clinicaltrials.gov/search?id=%22NCT01327846%22</a>   |
| CHEMBL1201834 | CANAKINUMAB | Antibody | Interleukin-1 beta inhibitor | Inhibitor | EFO_1001999     | systemic juvenile idiopathic arthritis | 3 Terminated             | <a href="https://clinicaltrials.gov/search?id=%22NCT00886769%22">https://clinicaltrials.gov/search?id=%22NCT00886769%22</a>   |
| CHEMBL1201834 | CANAKINUMAB | Antibody | Interleukin-1 beta inhibitor | Inhibitor | Orphanet_1451   | CINCA syndrome                         | 3 Terminated             | <a href="https://clinicaltrials.gov/search?id=%22NCT00770601%22">https://clinicaltrials.gov/search?id=%22NCT00770601%22</a>   |
| CHEMBL1201834 | CANAKINUMAB | Antibody | Interleukin-1 beta inhibitor | Inhibitor | DOID_13406      | pulmonary sarcoidosis                  | 2 Completed              | <a href="https://clinicaltrials.gov/search?id=%22NCT02888080%22">https://clinicaltrials.gov/search?id=%22NCT02888080%22</a>   |
| CHEMBL1201834 | CANAKINUMAB | Antibody | Interleukin-1 beta inhibitor | Inhibitor | EFO_0000275     | atrial fibrillation                    | 2 Terminated             | <a href="https://clinicaltrials.gov/search?id=%22NCT01805960%22">https://clinicaltrials.gov/search?id=%22NCT01805960%22</a>   |
| CHEMBL1201834 | CANAKINUMAB | Antibody | Interleukin-1 beta inhibitor | Inhibitor | EFO_0000756     | melanoma                               | 2 Recruiting             | <a href="https://clinicaltrials.gov/search?id=%22NCT03484923%22">https://clinicaltrials.gov/search?id=%22NCT03484923%22</a>   |
| CHEMBL1201834 | CANAKINUMAB | Antibody | Interleukin-1 beta inhibitor | Inhibitor | EFO_0001071     | lung carcinoma                         | 2 Not yet recruiting     | <a href="https://clinicaltrials.gov/search?id=%22NCT04789681%22">https://clinicaltrials.gov/search?id=%22NCT04789681%22</a>   |
| CHEMBL1201834 | CANAKINUMAB | Antibody | Interleukin-1 beta inhibitor | Inhibitor | EFO_0001359     | type I diabetes mellitus               | 2 Completed              | <a href="https://clinicaltrials.gov/search?id=%22NCT00947427%22">https://clinicaltrials.gov/search?id=%22NCT00947427%22</a>   |
| CHEMBL1201834 | CANAKINUMAB | Antibody | Interleukin-1 beta inhibitor | Inhibitor | EFO_0001360     | type II diabetes mellitus              | 2 Terminated             | <a href="https://clinicaltrials.gov/search?id=%22NCT00900146%22">https://clinicaltrials.gov/search?id=%22NCT00900146%22</a>   |
| CHEMBL1201834 | CANAKINUMAB | Antibody | Interleukin-1 beta inhibitor | Inhibitor | EFO_0002506     | osteoarthritis                         | 2 Completed              | <a href="https://clinicaltrials.gov/search?id=%22NCT01160822%22">https://clinicaltrials.gov/search?id=%22NCT01160822%22</a>   |
| CHEMBL1201834 | CANAKINUMAB | Antibody | Interleukin-1 beta inhibitor | Inhibitor | EFO_0003780     | Behcet's syndrome                      | 2 Completed              | <a href="https://clinicaltrials.gov/search?id=%22NCT02756650%22">https://clinicaltrials.gov/search?id=%22NCT02756650%22</a>   |
| CHEMBL1201834 | CANAKINUMAB | Antibody | Interleukin-1 beta inhibitor | Inhibitor | EFO_0004214     | Abdominal Aortic Aneurysm              | 2 Terminated             | <a href="https://clinicaltrials.gov/search?id=%22NCT02007252%22">https://clinicaltrials.gov/search?id=%22NCT02007252%22</a>   |
| CHEMBL1201834 | CANAKINUMAB | Antibody | Interleukin-1 beta inhibitor | Inhibitor | EFO_0004246     | mucocutaneous lymph node syndrome      | 2 Withdrawn              | <a href="https://clinicaltrials.gov/search?id=%22NCT02980263%22">https://clinicaltrials.gov/search?id=%22NCT02980263%22</a>   |
| CHEMBL1201834 | CANAKINUMAB | Antibody | Interleukin-1 beta inhibitor | Inhibitor | EFO_0004265     | peripheral arterial disease            | 2 Terminated             | <a href="https://clinicaltrials.gov/search?id=%22NCT01731990%22">https://clinicaltrials.gov/search?id=%22NCT01731990%22</a>   |
| CHEMBL1201834 | CANAKINUMAB | Antibody | Interleukin-1 beta inhibitor | Inhibitor | EFO_0004274     | gout                                   | 2 Completed              | <a href="https://clinicaltrials.gov/search?id=%22NCT00819585%22">https://clinicaltrials.gov/search?id=%22NCT00819585%22</a> , <a href="https://clinicaltrials.gov/sea">https://clinicaltrials.gov/sea</a> |
| CHEMBL1201834 | CANAKINUMAB | Antibody | Interleukin-1 beta inhibitor | Inhibitor | EFO_0005531     | urticaria                              | 2 Unknown status         | <a href="https://clinicaltrials.gov/search?id=%22NCT01635127%22">https://clinicaltrials.gov/search?id=%22NCT01635127%22</a>   |
| CHEMBL1201834 | CANAKINUMAB | Antibody | Interleukin-1 beta inhibitor | Inhibitor | EFO_0007135     | adult-onset Still's disease            | 2 Terminated             | <a href="https://clinicaltrials.gov/search?id=%22NCT02204293%22">https://clinicaltrials.gov/search?id=%22NCT02204293%22</a>   |
| CHEMBL1201834 | CANAKINUMAB | Antibody | Interleukin-1 beta inhibitor | Inhibitor | EFO_0008518     | polymyalgia rheumatica                 | 2 Terminated             | <a href="https://clinicaltrials.gov/search?id=%22NCT01364389%22">https://clinicaltrials.gov/search?id=%22NCT01364389%22</a>   |
| CHEMBL1201834 | CANAKINUMAB | Antibody | Interleukin-1 beta inhibitor | Inhibitor | EFO_1000906     | dry eye syndrome                       | 2 Completed              | <a href="https://clinicaltrials.gov/search?id=%22NCT01250171%22">https://clinicaltrials.gov/search?id=%22NCT01250171%22</a>   |
| CHEMBL1201834 | CANAKINUMAB | Antibody | Interleukin-1 beta inhibitor | Inhibitor | EFO_1001165     | Schnitzler syndrome                    | 2 Completed              | <a href="https://clinicaltrials.gov/search?id=%22NCT01390350%22">https://clinicaltrials.gov/search?id=%22NCT01390350%22</a> , <a href="https://clinicaltrials.gov/sea">https://clinicaltrials.gov/sea</a> |
| CHEMBL1201834 | CANAKINUMAB | Antibody | Interleukin-1 beta inhibitor | Inhibitor | EFO_1001345     | Hepatitis, Alcoholic                   | 2 Active, not recruiting | <a href="https://clinicaltrials.gov/search?id=%22NCT03775109%22">https://clinicaltrials.gov/search?id=%22NCT03775109%22</a>   |
| CHEMBL1201834 | CANAKINUMAB | Antibody | Interleukin-1 beta inhibitor | Inhibitor | HP_0000999      | Pyoderma                               | 2 Completed              | <a href="https://clinicaltrials.gov/search?id=%22NCT01302795%22">https://clinicaltrials.gov/search?id=%22NCT01302795%22</a>   |
| CHEMBL1201834 | CANAKINUMAB | Antibody | Interleukin-1 beta inhibitor | Inhibitor | MONDO_0100096   | COVID-19                               | 2 Completed              | <a href="https://clinicaltrials.gov/search?id=%22NCT04365153%22">https://clinicaltrials.gov/search?id=%22NCT04365153%22</a>   |
| CHEMBL1201834 | CANAKINUMAB | Antibody | Interleukin-1 beta inhibitor | Inhibitor | Orphanet_232    | Sickle cell anemia                     | 2 Completed              | <a href="https://clinicaltrials.gov/search?id=%22NCT02961218%22">https://clinicaltrials.gov/search?id=%22NCT02961218%22</a>   |
| CHEMBL1201834 | CANAKINUMAB | Antibody | Interleukin-1 beta inhibitor | Inhibitor | Orphanet_309025 | Mevalonate kinase deficiency           | 2 Completed              | <a href="https://clinicaltrials.gov/search?id=%22NCT01303380%22">https://clinicaltrials.gov/search?id=%22NCT01303380%22</a>   |
| CHEMBL1201834 | CANAKINUMAB | Antibody | Interleukin-1 beta inhibitor | Inhibitor | Orphanet_342    | Familial Mediterranean fever           | 2 Completed              | <a href="https://clinicaltrials.gov/search?id=%22NCT01148797%22">https://clinicaltrials.gov/search?id=%22NCT01148797%22</a> , <a href="https://clinicaltrials.gov/sea">https://clinicaltrials.gov/sea</a> |
| CHEMBL1201834 | CANAKINUMAB | Antibody | Interleukin-1 beta inhibitor | Inhibitor | EFO_0000198     | myelodysplastic syndrome               | 1 Recruiting             | <a href="https://clinicaltrials.gov/search?id=%22NCT04810611%22">https://clinicaltrials.gov/search?id=%22NCT04810611%22</a> , <a href="https://clinicaltrials.gov/sea">https://clinicaltrials.gov/sea</a> |
| CHEMBL1201834 | CANAKINUMAB | Antibody | Interleukin-1 beta inhibitor | Inhibitor | EFO_0000341     | chronic obstructive pulmonary disease  | 1 Completed              | <a href="https://clinicaltrials.gov/search?id=%22NCT00581945%22">https://clinicaltrials.gov/search?id=%22NCT00581945%22</a>   |
| CHEMBL1201834 | CANAKINUMAB | Antibody | Interleukin-1 beta inhibitor | Inhibitor | EFO_0000685     | rheumatoid arthritis                   | 1 Terminated             | <a href="https://clinicaltrials.gov/search?id=%22NCT00505089%22">https://clinicaltrials.gov/search?id=%22NCT00505089%22</a>   |
| CHEMBL1201834 | CANAKINUMAB | Antibody | Interleukin-1 beta inhibitor | Inhibitor | EFO_0001365     | age-related macular degeneration       | 1 Completed              | <a href="https://clinicaltrials.gov/search?id=%22NCT00503022%22">https://clinicaltrials.gov/search?id=%22NCT00503022%22</a>   |
| CHEMBL1201834 | CANAKINUMAB | Antibody | Interleukin-1 beta inhibitor | Inhibitor | EFO_0002517     | pancreatic ductal adenocarcinoma       | 1 Recruiting             | <a href="https://clinicaltrials.gov/search?id=%22NCT04581343%22">https://clinicaltrials.gov/search?id=%22NCT04581343%22</a>   |
| CHEMBL1201834 | CANAKINUMAB | Antibody | Interleukin-1 beta inhibitor | Inhibitor | EFO_0002609     | juvenile idiopathic arthritis          | 1 Completed              | <a href="https://clinicaltrials.gov/search?id=%22NCT00426218%22">https://clinicaltrials.gov/search?id=%22NCT00426218%22</a>   |

|               |                       |          |   |               |               |                                     |   |                        |   |
|---------------|-----------------------|----------|---|---------------|---------------|-------------------------------------|---|------------------------|---|
| CHEMBL1201834 | CANAKINUMAB           | Antibody | Interleukin-1 beta inhibitor                      | Inhibitor     | EFO_0003060   | non-small cell lung carcinoma       | 1 | Active, not recruiting | <a href="https://clinicaltrials.gov/search?id=%22NCT03064854%22">https://clinicaltrials.gov/search?id=%22NCT03064854%22</a>   |
| CHEMBL1201834 | CANAKINUMAB           | Antibody | Interleukin-1 beta inhibitor                      | Inhibitor     | EFO_0009322   | proliferative diabetic retinopathy  | 1 | Terminated             | <a href="https://clinicaltrials.gov/search?id=%22NCT01589029%22">https://clinicaltrials.gov/search?id=%22NCT01589029%22</a>   |
| CHEMBL1201834 | CANAKINUMAB           | Antibody | Interleukin-1 beta inhibitor                      | Inhibitor     | HP_0001945    | Fever                               | 1 | Unknown status         | <a href="https://clinicaltrials.gov/search?id=%22NCT02775994%22">https://clinicaltrials.gov/search?id=%22NCT02775994%22</a>   |
| CHEMBL1201834 | CANAKINUMAB           | Antibody | Interleukin-1 beta inhibitor                      | Inhibitor     | MONDO_0007254 | breast cancer                       | 1 | Recruiting             | <a href="https://clinicaltrials.gov/search?id=%22NCT03742349%22">https://clinicaltrials.gov/search?id=%22NCT03742349%22</a>   |
| CHEMBL1201834 | CANAKINUMAB           | Antibody | Interleukin-1 beta inhibitor                      | Inhibitor     | EFO_0000681   | renal cell carcinoma                | 0 | Recruiting             | <a href="https://clinicaltrials.gov/search?id=%22NCT04028245%22">https://clinicaltrials.gov/search?id=%22NCT04028245%22</a>   |
| CHEMBL2109286 | COLTUXIMAB RAVTANSINE | Antibody | B-lymphocyte antigen CD19 binding agent           | Binding agent | EFO_0000220   | acute lymphoblastic leukemia        | 2 | Terminated             | <a href="https://clinicaltrials.gov/search?id=%22NCT01440179%22">https://clinicaltrials.gov/search?id=%22NCT01440179%22</a>   |
| CHEMBL2109286 | COLTUXIMAB RAVTANSINE | Antibody | B-lymphocyte antigen CD19 binding agent           | Binding agent | EFO_0000403   | diffuse large B-cell lymphoma       | 2 | Completed              | <a href="https://clinicaltrials.gov/search?id=%22NCT01472887%22">https://clinicaltrials.gov/search?id=%22NCT01472887%22</a> , <a href="https://clinicaltrials.gov/sea">https://clinicaltrials.gov/sea</a> |
| CHEMBL2109286 | COLTUXIMAB RAVTANSINE | Antibody | B-lymphocyte antigen CD19 binding agent           | Binding agent | EFO_0005952   | non-Hodgkins lymphoma               | 1 | Completed              | <a href="https://clinicaltrials.gov/search?id=%22NCT00796731%22">https://clinicaltrials.gov/search?id=%22NCT00796731%22</a> , <a href="https://clinicaltrials.gov/sea">https://clinicaltrials.gov/sea</a> |
| CHEMBL1743007 | DARATUMUMAB           | Antibody | Lymphocyte differentiation antigen CD38 inhibitor | Inhibitor     | EFO_0003073   | asymptomatic myeloma                | 3 | Recruiting             | <a href="https://clinicaltrials.gov/search?id=%22NCT03937635%22">https://clinicaltrials.gov/search?id=%22NCT03937635%22</a>   |
| CHEMBL1743007 | DARATUMUMAB           | Antibody | Lymphocyte differentiation antigen CD38 inhibitor | Inhibitor     | EFO_0000203   | monoclonal gammopathy               | 2 | Active, not recruiting | <a href="https://clinicaltrials.gov/search?id=%22NCT03236428%22">https://clinicaltrials.gov/search?id=%22NCT03236428%22</a>   |
| CHEMBL1743007 | DARATUMUMAB           | Antibody | Lymphocyte differentiation antigen CD38 inhibitor | Inhibitor     | EFO_0000209   | T-cell acute lymphoblastic leukemia | 2 | Not yet recruiting     | <a href="https://clinicaltrials.gov/search?id=%22NCT04972942%22">https://clinicaltrials.gov/search?id=%22NCT04972942%22</a>   |
| CHEMBL1743007 | DARATUMUMAB           | Antibody | Lymphocyte differentiation antigen CD38 inhibitor | Inhibitor     | EFO_0000220   | acute lymphoblastic leukemia        | 2 | Recruiting             | <a href="https://clinicaltrials.gov/search?id=%22NCT03384654%22">https://clinicaltrials.gov/search?id=%22NCT03384654%22</a>   |
| CHEMBL1743007 | DARATUMUMAB           | Antibody | Lymphocyte differentiation antigen CD38 inhibitor | Inhibitor     | EFO_0000222   | acute myeloid leukemia              | 2 | Active, not recruiting | <a href="https://clinicaltrials.gov/search?id=%22NCT02807558%22">https://clinicaltrials.gov/search?id=%22NCT02807558%22</a>   |
| CHEMBL1743007 | DARATUMUMAB           | Antibody | Lymphocyte differentiation antigen CD38 inhibitor | Inhibitor     | EFO_0000249   | Alzheimer's disease                 | 2 | Recruiting             | <a href="https://clinicaltrials.gov/search?id=%22NCT04070378%22">https://clinicaltrials.gov/search?id=%22NCT04070378%22</a>   |
| CHEMBL1743007 | DARATUMUMAB           | Antibody | Lymphocyte differentiation antigen CD38 inhibitor | Inhibitor     | EFO_0000574   | lymphoma                            | 2 | Completed              | <a href="https://clinicaltrials.gov/search?id=%22NCT02927925%22">https://clinicaltrials.gov/search?id=%22NCT02927925%22</a>   |
| CHEMBL1743007 | DARATUMUMAB           | Antibody | Lymphocyte differentiation antigen CD38 inhibitor | Inhibitor     | EFO_0000616   | neoplasm                            | 2 | Withdrawn              | <a href="https://clinicaltrials.gov/search?id=%22NCT03207542%22">https://clinicaltrials.gov/search?id=%22NCT03207542%22</a>   |
| CHEMBL1743007 | DARATUMUMAB           | Antibody | Lymphocyte differentiation antigen CD38 inhibitor | Inhibitor     | EFO_0002690   | systemic lupus erythematosus        | 2 | Not yet recruiting     | <a href="https://clinicaltrials.gov/search?id=%22NCT04810754%22">https://clinicaltrials.gov/search?id=%22NCT04810754%22</a>   |
| CHEMBL1743007 | DARATUMUMAB           | Antibody | Lymphocyte differentiation antigen CD38 inhibitor | Inhibitor     | EFO_0005761   | lupus nephritis                     | 2 | Recruiting             | <a href="https://clinicaltrials.gov/search?id=%22NCT04868838%22">https://clinicaltrials.gov/search?id=%22NCT04868838%22</a>   |
| CHEMBL1743007 | DARATUMUMAB           | Antibody | Lymphocyte differentiation antigen CD38 inhibitor | Inhibitor     | EFO_0006738   | plasmacytoma                        | 2 | Recruiting             | <a href="https://clinicaltrials.gov/search?id=%22NCT04166565%22">https://clinicaltrials.gov/search?id=%22NCT04166565%22</a>   |
| CHEMBL1743007 | DARATUMUMAB           | Antibody | Lymphocyte differentiation antigen CD38 inhibitor | Inhibitor     | EFO_0007160   | autoimmune thrombocytopenic purpu   | 2 | Recruiting             | <a href="https://clinicaltrials.gov/search?id=%22NCT04703621%22">https://clinicaltrials.gov/search?id=%22NCT04703621%22</a>   |
| CHEMBL1743007 | DARATUMUMAB           | Antibody | Lymphocyte differentiation antigen CD38 inhibitor | Inhibitor     | EFO_0009441   | Waldenstrom macroglobulinemia       | 2 | Recruiting             | <a href="https://clinicaltrials.gov/search?id=%22NCT03679624%22">https://clinicaltrials.gov/search?id=%22NCT03679624%22</a>   |
| CHEMBL1743007 | DARATUMUMAB           | Antibody | Lymphocyte differentiation antigen CD38 inhibitor | Inhibitor     | EFO_1001115   | POEMS syndrome                      | 2 | Recruiting             | <a href="https://clinicaltrials.gov/search?id=%22NCT04396496%22">https://clinicaltrials.gov/search?id=%22NCT04396496%22</a>   |
| CHEMBL1743007 | DARATUMUMAB           | Antibody | Lymphocyte differentiation antigen CD38 inhibitor | Inhibitor     | EFO_1001469   | Mantle cell lymphoma                | 2 | Terminated             | <a href="https://clinicaltrials.gov/search?id=%22NCT02413489%22">https://clinicaltrials.gov/search?id=%22NCT02413489%22</a>   |
| CHEMBL1743007 | DARATUMUMAB           | Antibody | Lymphocyte differentiation antigen CD38 inhibitor | Inhibitor     | EFO_1001875   | amyloidosis                         | 2 | Completed              | <a href="https://clinicaltrials.gov/search?id=%22NCT02816476%22">https://clinicaltrials.gov/search?id=%22NCT02816476%22</a>   |
| CHEMBL1743007 | DARATUMUMAB           | Antibody | Lymphocyte differentiation antigen CD38 inhibitor | Inhibitor     | EFO_1001951   | colorectal carcinoma                | 2 | Active, not recruiting | <a href="https://clinicaltrials.gov/search?id=%22NCT02060188%22">https://clinicaltrials.gov/search?id=%22NCT02060188%22</a>   |
| CHEMBL1743007 | DARATUMUMAB           | Antibody | Lymphocyte differentiation antigen CD38 inhibitor | Inhibitor     | MONDO_0008315 | prostate cancer                     | 2 | Withdrawn              | <a href="https://clinicaltrials.gov/search?id=%22NCT03035357%22">https://clinicaltrials.gov/search?id=%22NCT03035357%22</a>   |
| CHEMBL1743007 | DARATUMUMAB           | Antibody | Lymphocyte differentiation antigen CD38 inhibitor | Inhibitor     | MONDO_0018906 | follicular lymphoma                 | 2 | Terminated             | <a href="https://clinicaltrials.gov/search?id=%22NCT02413489%22">https://clinicaltrials.gov/search?id=%22NCT02413489%22</a>   |
| CHEMBL1743007 | DARATUMUMAB           | Antibody | Lymphocyte differentiation antigen CD38 inhibitor | Inhibitor     | EFO_0000095   | chronic lymphocytic leukemia        | 1 | Recruiting             | <a href="https://clinicaltrials.gov/search?id=%22NCT03447808%22">https://clinicaltrials.gov/search?id=%22NCT03447808%22</a>   |
| CHEMBL1743007 | DARATUMUMAB           | Antibody | Lymphocyte differentiation antigen CD38 inhibitor | Inhibitor     | EFO_0000183   | Hodgkins lymphoma                   | 1 | Suspended              | <a href="https://clinicaltrials.gov/search?id=%22NCT03432741%22">https://clinicaltrials.gov/search?id=%22NCT03432741%22</a>   |
| CHEMBL1743007 | DARATUMUMAB           | Antibody | Lymphocyte differentiation antigen CD38 inhibitor | Inhibitor     | EFO_0000198   | myelodysplastic syndrome            | 1 | Recruiting             | <a href="https://clinicaltrials.gov/search?id=%22NCT03537599%22">https://clinicaltrials.gov/search?id=%22NCT03537599%22</a>   |
| CHEMBL1743007 | DARATUMUMAB           | Antibody | Lymphocyte differentiation antigen CD38 inhibitor | Inhibitor     | EFO_0000304   | breast adenocarcinoma               | 1 | Suspended              | <a href="https://clinicaltrials.gov/search?id=%22NCT03432741%22">https://clinicaltrials.gov/search?id=%22NCT03432741%22</a>   |
| CHEMBL1743007 | DARATUMUMAB           | Antibody | Lymphocyte differentiation antigen CD38 inhibitor | Inhibitor     | EFO_0000311   | cancer                              | 1 | Completed              | <a href="https://clinicaltrials.gov/search?id=%22NCT03098550%22">https://clinicaltrials.gov/search?id=%22NCT03098550%22</a>   |

|               |                        |          |   |               |                |                                     |                          |   |
|---------------|------------------------|----------|---|---------------|----------------|-------------------------------------|--------------------------|---|
| CHEMBL1743007 | DARATUMUMAB            | Antibody | Lymphocyte differentiation antigen CD38 inhibitor | Inhibitor     | EFO_0000330    | childhood acute myeloid leukemia    | 1 Recruiting             | <a href="https://clinicaltrials.gov/search?id=%22NCT03537599%22">https://clinicaltrials.gov/search?id=%22NCT03537599%22</a>   |
| CHEMBL1743007 | DARATUMUMAB            | Antibody | Lymphocyte differentiation antigen CD38 inhibitor | Inhibitor     | EFO_0000519    | glioblastoma multiforme             | 1 Not yet recruiting     | <a href="https://clinicaltrials.gov/search?id=%22NCT04922723%22">https://clinicaltrials.gov/search?id=%22NCT04922723%22</a>   |
| CHEMBL1743007 | DARATUMUMAB            | Antibody | Lymphocyte differentiation antigen CD38 inhibitor | Inhibitor     | EFO_0000673    | prostate adenocarcinoma             | 1 Active, not recruiting | <a href="https://clinicaltrials.gov/search?id=%22NCT03177460%22">https://clinicaltrials.gov/search?id=%22NCT03177460%22</a>   |
| CHEMBL1743007 | DARATUMUMAB            | Antibody | Lymphocyte differentiation antigen CD38 inhibitor | Inhibitor     | EFO_0001378    | multiple myeloma                    | 1 Withdrawn              | <a href="https://clinicaltrials.gov/search?id=%22NCT03701321%22">https://clinicaltrials.gov/search?id=%22NCT03701321%22</a> , <a href="https://clinicaltrials.gov/sea">https://clinicaltrials.gov/sea</a> |
| CHEMBL1743007 | DARATUMUMAB            | Antibody | Lymphocyte differentiation antigen CD38 inhibitor | Inhibitor     | EFO_0003060    | non-small cell lung carcinoma       | 1 Completed              | <a href="https://clinicaltrials.gov/search?id=%22NCT03023423%22">https://clinicaltrials.gov/search?id=%22NCT03023423%22</a>   |
| CHEMBL1743007 | DARATUMUMAB            | Antibody | Lymphocyte differentiation antigen CD38 inhibitor | Inhibitor     | EFO_0004599    | acute graft vs. host disease        | 1 Recruiting             | <a href="https://clinicaltrials.gov/search?id=%22NCT04204980%22">https://clinicaltrials.gov/search?id=%22NCT04204980%22</a>   |
| CHEMBL1743007 | DARATUMUMAB            | Antibody | Lymphocyte differentiation antigen CD38 inhibitor | Inhibitor     | EFO_0005952    | non-Hodgkins lymphoma               | 1 Active, not recruiting | <a href="https://clinicaltrials.gov/search?id=%22NCT01592370%22">https://clinicaltrials.gov/search?id=%22NCT01592370%22</a>   |
| CHEMBL1743007 | DARATUMUMAB            | Antibody | Lymphocyte differentiation antigen CD38 inhibitor | Inhibitor     | EFO_0006475    | plasma cell leukemia                | 1 Withdrawn              | <a href="https://clinicaltrials.gov/search?id=%22NCT03591744%22">https://clinicaltrials.gov/search?id=%22NCT03591744%22</a>   |
| CHEMBL1743007 | DARATUMUMAB            | Antibody | Lymphocyte differentiation antigen CD38 inhibitor | Inhibitor     | EFO_1001051    | mycosis fungoides                   | 1 Suspended              | <a href="https://clinicaltrials.gov/search?id=%22NCT03432741%22">https://clinicaltrials.gov/search?id=%22NCT03432741%22</a>   |
| CHEMBL1743007 | DARATUMUMAB            | Antibody | Lymphocyte differentiation antigen CD38 inhibitor | Inhibitor     | MONDO_0019465  | nodal marginal zone B-cell lymphoma | 1 Suspended              | <a href="https://clinicaltrials.gov/search?id=%22NCT03432741%22">https://clinicaltrials.gov/search?id=%22NCT03432741%22</a>   |
| CHEMBL1743007 | DARATUMUMAB            | Antibody | Lymphocyte differentiation antigen CD38 inhibitor | Inhibitor     | Orphanet_85443 | AL amyloidosis                      | 1 Recruiting             | <a href="https://clinicaltrials.gov/search?id=%22NCT03283917%22">https://clinicaltrials.gov/search?id=%22NCT03283917%22</a>   |
| CHEMBL1743007 | DARATUMUMAB            | Antibody | Lymphocyte differentiation antigen CD38 inhibitor | Inhibitor     | EFO_0000349    | clear cell renal carcinoma          | 0 Active, not recruiting | <a href="https://clinicaltrials.gov/search?id=%22NCT03473730%22">https://clinicaltrials.gov/search?id=%22NCT03473730%22</a>   |
| CHEMBL1743007 | DARATUMUMAB            | Antibody | Lymphocyte differentiation antigen CD38 inhibitor | Inhibitor     | EFO_0000403    | diffuse large B-cell lymphoma       | 0 Recruiting             | <a href="https://clinicaltrials.gov/search?id=%22NCT04139304%22">https://clinicaltrials.gov/search?id=%22NCT04139304%22</a>   |
| CHEMBL1743007 | DARATUMUMAB            | Antibody | Lymphocyte differentiation antigen CD38 inhibitor | Inhibitor     | EFO_0006544    | bladder transitional cell carcinoma | 0 Active, not recruiting | <a href="https://clinicaltrials.gov/search?id=%22NCT03473730%22">https://clinicaltrials.gov/search?id=%22NCT03473730%22</a>   |
| CHEMBL3545371 | DENINTUZUMAB MAFODOTIN | Antibody | B-lymphocyte antigen CD19 binding agent           | Binding agent | EFO_0000220    | acute lymphoblastic leukemia        | 1 Completed              | <a href="https://clinicaltrials.gov/search?id=%22NCT01786135%22">https://clinicaltrials.gov/search?id=%22NCT01786135%22</a>   |
| CHEMBL3545371 | DENINTUZUMAB MAFODOTIN | Antibody | B-lymphocyte antigen CD19 binding agent           | Binding agent | EFO_0000309    | Burkitts lymphoma                   | 1 Completed              | <a href="https://clinicaltrials.gov/search?id=%22NCT01786135%22">https://clinicaltrials.gov/search?id=%22NCT01786135%22</a>   |
| CHEMBL3545371 | DENINTUZUMAB MAFODOTIN | Antibody | B-lymphocyte antigen CD19 binding agent           | Binding agent | EFO_0000403    | diffuse large B-cell lymphoma       | 1 Completed              | <a href="https://clinicaltrials.gov/search?id=%22NCT01786135%22">https://clinicaltrials.gov/search?id=%22NCT01786135%22</a>   |
| CHEMBL3545371 | DENINTUZUMAB MAFODOTIN | Antibody | B-lymphocyte antigen CD19 binding agent           | Binding agent | EFO_1001469    | Mantle cell lymphoma                | 1 Completed              | <a href="https://clinicaltrials.gov/search?id=%22NCT01786135%22">https://clinicaltrials.gov/search?id=%22NCT01786135%22</a>   |
| CHEMBL3545371 | DENINTUZUMAB MAFODOTIN | Antibody | B-lymphocyte antigen CD19 binding agent           | Binding agent | MONDO_0018906  | follicular lymphoma                 | 1 Completed              | <a href="https://clinicaltrials.gov/search?id=%22NCT01786135%22">https://clinicaltrials.gov/search?id=%22NCT01786135%22</a>   |
| CHEMBL4594579 | FELZARTAMAB            | Antibody | Lymphocyte differentiation antigen CD38 inhibitor | Inhibitor     | EFO_0003086    | kidney disease                      | 2 Not yet recruiting     | <a href="https://clinicaltrials.gov/search?id=%22NCT04893096%22">https://clinicaltrials.gov/search?id=%22NCT04893096%22</a>   |
| CHEMBL4594579 | FELZARTAMAB            | Antibody | Lymphocyte differentiation antigen CD38 inhibitor | Inhibitor     | MONDO_0002462  | glomerulonephritis                  | 2 Recruiting             | <a href="https://clinicaltrials.gov/search?id=%22NCT04733040%22">https://clinicaltrials.gov/search?id=%22NCT04733040%22</a>   |
| CHEMBL4594579 | FELZARTAMAB            | Antibody | Lymphocyte differentiation antigen CD38 inhibitor | Inhibitor     | EFO_0001378    | multiple myeloma                    | 1 Completed              | <a href="https://clinicaltrials.gov/search?id=%22NCT01421186%22">https://clinicaltrials.gov/search?id=%22NCT01421186%22</a>   |
| CHEMBL4594579 | FELZARTAMAB            | Antibody | Lymphocyte differentiation antigen CD38 inhibitor | Inhibitor     | EFO_0004254    | membranous glomerulonephritis       | 1 Recruiting             | <a href="https://clinicaltrials.gov/search?id=%22NCT04145440%22">https://clinicaltrials.gov/search?id=%22NCT04145440%22</a>   |
| CHEMBL3990038 | FLOTETUZUMAB           | Antibody | T cell surface glycoprotein CD3 binding agent     | Binding agent | EFO_0000222    | acute myeloid leukemia              | 1 Recruiting             | <a href="https://clinicaltrials.gov/search?id=%22NCT02152956%22">https://clinicaltrials.gov/search?id=%22NCT02152956%22</a> , <a href="https://clinicaltrials.gov/sea">https://clinicaltrials.gov/sea</a> |
| CHEMBL1743020 | FORALUMAB              | Antibody | T cell surface glycoprotein CD3 inhibitor         | Inhibitor     | EFO_0000384    | Crohn's disease                     | 1 Completed              | <a href="https://clinicaltrials.gov/search?id=%22NCT00630643%22">https://clinicaltrials.gov/search?id=%22NCT00630643%22</a>   |
| CHEMBL1743020 | FORALUMAB              | Antibody | T cell surface glycoprotein CD3 inhibitor         | Inhibitor     | EFO_0004599    | acute graft vs. host disease        | 1 Completed              | <a href="https://clinicaltrials.gov/search?id=%22NCT00805909%22">https://clinicaltrials.gov/search?id=%22NCT00805909%22</a>   |
| CHEMBL2108342 | GEMTUZUMAB             | Antibody | Myeloid cell surface antigen CD33 binding agent   | Binding agent | EFO_0000222    | acute myeloid leukemia              | 3 Completed              | <a href="https://clinicaltrials.gov/search?id=%22NCT00136084%22">https://clinicaltrials.gov/search?id=%22NCT00136084%22</a>   |
| CHEMBL1201506 | GEMTUZUMAB OZOGAMICIN  | Antibody | Myeloid cell surface antigen CD33 binding agent   | Binding agent | EFO_0000616    | neoplasm                            | 4                        | <a href="http://www.whocc.no/atc_ddd_index/?code=L01XC05">http://www.whocc.no/atc_ddd_index/?code=L01XC05</a>   |
| CHEMBL1201506 | GEMTUZUMAB OZOGAMICIN  | Antibody | Myeloid cell surface antigen CD33 binding agent   | Binding agent | EFO_0000220    | acute lymphoblastic leukemia        | 2 Terminated             | <a href="https://clinicaltrials.gov/search?id=%22NCT00798213%22">https://clinicaltrials.gov/search?id=%22NCT00798213%22</a>   |
| CHEMBL1201506 | GEMTUZUMAB OZOGAMICIN  | Antibody | Myeloid cell surface antigen CD33 binding agent   | Binding agent | EFO_0000224    | acute promyelocytic leukemia        | 2 Withdrawn              | <a href="https://clinicaltrials.gov/search?id=%22NCT01548911%22">https://clinicaltrials.gov/search?id=%22NCT01548911%22</a>   |
| CHEMBL1201506 | GEMTUZUMAB OZOGAMICIN  | Antibody | Myeloid cell surface antigen CD33 binding agent   | Binding agent | EFO_0000095    | chronic lymphocytic leukemia        | 1 Completed              | <a href="https://clinicaltrials.gov/search?id=%22NCT00038831%22">https://clinicaltrials.gov/search?id=%22NCT00038831%22</a>   |
| CHEMBL1201506 | GEMTUZUMAB OZOGAMICIN  | Antibody | Myeloid cell surface antigen CD33 binding agent   | Binding agent | EFO_0000198    | myelodysplastic syndrome            | 1 Active, not recruiting | <a href="https://clinicaltrials.gov/search?id=%22NCT01020539%22">https://clinicaltrials.gov/search?id=%22NCT01020539%22</a>   |

|               |                       |          |   |                       |               |                                      |                          |   |
|---------------|-----------------------|----------|---|-----------------------|---------------|--------------------------------------|--------------------------|---|
| CHEMBL1201506 | GEMTUZUMAB OZOGAMICIN | Antibody | Myeloid cell surface antigen CD33 binding agent             | Binding agent         | EFO_0000565   | leukemia                             | 1 Terminated             | <a href="https://clinicaltrials.gov/search?id=%22NCT00577694%22">https://clinicaltrials.gov/search?id=%22NCT00577694%22</a>   |
| CHEMBL1201506 | GEMTUZUMAB OZOGAMICIN | Antibody | Myeloid cell surface antigen CD33 binding agent             | Binding agent         | EFO_1000309   | Juvenile Myelomonocytic Leukemia     | 1 Terminated             | <a href="https://clinicaltrials.gov/search?id=%22NCT00669890%22">https://clinicaltrials.gov/search?id=%22NCT00669890%22</a>   |
| CHEMBL1201506 | GEMTUZUMAB OZOGAMICIN | Antibody | Myeloid cell surface antigen CD33 binding agent             | Binding agent         | MONDO_0019457 | therapy related acute myeloid leukem | 1 Recruiting             | <a href="https://clinicaltrials.gov/search?id=%22NCT04915612%22">https://clinicaltrials.gov/search?id=%22NCT04915612%22</a>   |
| CHEMBL1201506 | GEMTUZUMAB OZOGAMICIN | Antibody | Myeloid cell surface antigen CD33 binding agent             | Binding agent         | EFO_0000222   | acute myeloid leukemia               | 0 Active, not recruiting | <a href="https://clinicaltrials.gov/search?id=%22NCT03568994%22">https://clinicaltrials.gov/search?id=%22NCT03568994%22</a>   |
| CHEMBL1743026 | GEVOKIZUMAB           | Antibody | Interleukin-1 beta negative allosteric modulator            | Negative allosteric m | EFO_1001231   | uveitis                              | 3 Terminated             | <a href="https://clinicaltrials.gov/search?id=%22NCT02258854%22">https://clinicaltrials.gov/search?id=%22NCT02258854%22</a> , <a href="https://clinicaltrials.gov/sea">https://clinicaltrials.gov/sea</a> |
| CHEMBL1743026 | GEVOKIZUMAB           | Antibody | Interleukin-1 beta negative allosteric modulator            | Negative allosteric m | EFO_0000685   | rheumatoid arthritis                 | 2 Suspended              | <a href="https://clinicaltrials.gov/search?id=%22NCT00777816%22">https://clinicaltrials.gov/search?id=%22NCT00777816%22</a>   |
| CHEMBL1743026 | GEVOKIZUMAB           | Antibody | Interleukin-1 beta negative allosteric modulator            | Negative allosteric m | EFO_0001359   | type I diabetes mellitus             | 2 Completed              | <a href="https://clinicaltrials.gov/search?id=%22NCT00998699%22">https://clinicaltrials.gov/search?id=%22NCT00998699%22</a> , <a href="https://clinicaltrials.gov/sea">https://clinicaltrials.gov/sea</a> |
| CHEMBL1743026 | GEVOKIZUMAB           | Antibody | Interleukin-1 beta negative allosteric modulator            | Negative allosteric m | EFO_0002506   | osteoarthritis                       | 2 Completed              | <a href="https://clinicaltrials.gov/search?id=%22NCT01882491%22">https://clinicaltrials.gov/search?id=%22NCT01882491%22</a> , <a href="https://clinicaltrials.gov/sea">https://clinicaltrials.gov/sea</a> |
| CHEMBL1743026 | GEVOKIZUMAB           | Antibody | Interleukin-1 beta negative allosteric modulator            | Negative allosteric m | EFO_0003894   | acne                                 | 2 Completed              | <a href="https://clinicaltrials.gov/search?id=%22NCT01498874%22">https://clinicaltrials.gov/search?id=%22NCT01498874%22</a>   |
| CHEMBL1743026 | GEVOKIZUMAB           | Antibody | Interleukin-1 beta negative allosteric modulator            | Negative allosteric m | EFO_0009672   | inner ear disease                    | 2 Completed              | <a href="https://clinicaltrials.gov/search?id=%22NCT01950312%22">https://clinicaltrials.gov/search?id=%22NCT01950312%22</a>   |
| CHEMBL1743026 | GEVOKIZUMAB           | Antibody | Interleukin-1 beta negative allosteric modulator            | Negative allosteric m | HP_0000999    | Pyoderma                             | 2 Completed              | <a href="https://clinicaltrials.gov/search?id=%22NCT01882504%22">https://clinicaltrials.gov/search?id=%22NCT01882504%22</a>   |
| CHEMBL1743026 | GEVOKIZUMAB           | Antibody | Interleukin-1 beta negative allosteric modulator            | Negative allosteric m | EFO_0001360   | type II diabetes mellitus            | 1 Completed              | <a href="https://clinicaltrials.gov/search?id=%22NCT00513214%22">https://clinicaltrials.gov/search?id=%22NCT00513214%22</a> , <a href="https://clinicaltrials.gov/sea">https://clinicaltrials.gov/sea</a> |
| CHEMBL1743026 | GEVOKIZUMAB           | Antibody | Interleukin-1 beta negative allosteric modulator            | Negative allosteric m | EFO_0003780   | Behcet's syndrome                    | 1 Withdrawn              | <a href="https://clinicaltrials.gov/search?id=%22NCT01211977%22">https://clinicaltrials.gov/search?id=%22NCT01211977%22</a>   |
| CHEMBL1743026 | GEVOKIZUMAB           | Antibody | Interleukin-1 beta negative allosteric modulator            | Negative allosteric m | MONDO_0001718 | scleritis                            | 1 Completed              | <a href="https://clinicaltrials.gov/search?id=%22NCT01835132%22">https://clinicaltrials.gov/search?id=%22NCT01835132%22</a>   |
| CHEMBL2108707 | GLEMBATUMUMAB         | Antibody | Transmembrane glycoprotein NMB binding agent                | Binding agent         | EFO_0000756   | melanoma                             | 1 Completed              | <a href="https://clinicaltrials.gov/search?id=%22NCT00412828%22">https://clinicaltrials.gov/search?id=%22NCT00412828%22</a>   |
| CHEMBL2108707 | GLEMBATUMUMAB         | Antibody | Transmembrane glycoprotein NMB binding agent                | Binding agent         | MONDO_0007254 | breast cancer                        | 1 Completed              | <a href="https://clinicaltrials.gov/search?id=%22NCT00704158%22">https://clinicaltrials.gov/search?id=%22NCT00704158%22</a>   |
| CHEMBL1743028 | GLEMBATUMUMAB VEDOTIN | Antibody | Transmembrane glycoprotein NMB binding agent                | Binding agent         | EFO_0000637   | osteosarcoma                         | 2 Active, not recruiting | <a href="https://clinicaltrials.gov/search?id=%22NCT02487979%22">https://clinicaltrials.gov/search?id=%22NCT02487979%22</a>   |
| CHEMBL1743028 | GLEMBATUMUMAB VEDOTIN | Antibody | Transmembrane glycoprotein NMB binding agent                | Binding agent         | EFO_0000756   | melanoma                             | 2 Terminated             | <a href="https://clinicaltrials.gov/search?id=%22NCT02302339%22">https://clinicaltrials.gov/search?id=%22NCT02302339%22</a>   |
| CHEMBL1743028 | GLEMBATUMUMAB VEDOTIN | Antibody | Transmembrane glycoprotein NMB binding agent                | Binding agent         | EFO_1000616   | Uveal Melanoma                       | 2 Completed              | <a href="https://clinicaltrials.gov/search?id=%22NCT02363283%22">https://clinicaltrials.gov/search?id=%22NCT02363283%22</a>   |
| CHEMBL1743028 | GLEMBATUMUMAB VEDOTIN | Antibody | Transmembrane glycoprotein NMB binding agent                | Binding agent         | EFO_0000708   | squamous cell lung carcinoma         | 1 Terminated             | <a href="https://clinicaltrials.gov/search?id=%22NCT02713828%22">https://clinicaltrials.gov/search?id=%22NCT02713828%22</a>   |
| CHEMBL1743028 | GLEMBATUMUMAB VEDOTIN | Antibody | Transmembrane glycoprotein NMB binding agent                | Binding agent         | MONDO_0007254 | breast cancer                        | 0 Withdrawn              | <a href="https://clinicaltrials.gov/search?id=%22NCT03473691%22">https://clinicaltrials.gov/search?id=%22NCT03473691%22</a>   |
| CHEMBL2109509 | HCBE-11               | Antibody | Tumor necrosis factor receptor superfamily member 3 agonist | Agonist               | EFO_0000616   | neoplasm                             | 1 Terminated             | <a href="https://clinicaltrials.gov/search?id=%22NCT00105170%22">https://clinicaltrials.gov/search?id=%22NCT00105170%22</a>   |
| CHEMBL1201606 | IBRITUMOMAB TIUXETAN  | Antibody | B-lymphocyte antigen CD20 binding agent                     | Binding agent         | EFO_0000096   | neoplasm of mature B-cells           | 2 Completed              | <a href="https://clinicaltrials.gov/search?id=%22NCT00138086%22">https://clinicaltrials.gov/search?id=%22NCT00138086%22</a> , <a href="https://clinicaltrials.gov/sea">https://clinicaltrials.gov/sea</a> |
| CHEMBL1201606 | IBRITUMOMAB TIUXETAN  | Antibody | B-lymphocyte antigen CD20 binding agent                     | Binding agent         | MONDO_0013730 | graft versus host disease            | 2 Active, not recruiting | <a href="https://clinicaltrials.gov/search?id=%22NCT00577278%22">https://clinicaltrials.gov/search?id=%22NCT00577278%22</a>   |
| CHEMBL1201606 | IBRITUMOMAB TIUXETAN  | Antibody | B-lymphocyte antigen CD20 binding agent                     | Binding agent         | EFO_0000095   | chronic lymphocytic leukemia         | 1 Terminated             | <a href="https://clinicaltrials.gov/search?id=%22NCT00012298%22">https://clinicaltrials.gov/search?id=%22NCT00012298%22</a>   |
| CHEMBL1201606 | IBRITUMOMAB TIUXETAN  | Antibody | B-lymphocyte antigen CD20 binding agent                     | Binding agent         | EFO_0000183   | Hodgkins lymphoma                    | 1 Terminated             | <a href="https://clinicaltrials.gov/search?id=%22NCT00036855%22">https://clinicaltrials.gov/search?id=%22NCT00036855%22</a>   |
| CHEMBL1201606 | IBRITUMOMAB TIUXETAN  | Antibody | B-lymphocyte antigen CD20 binding agent                     | Binding agent         | EFO_0000191   | MALT lymphoma                        | 1 Terminated             | <a href="https://clinicaltrials.gov/search?id=%22NCT00012298%22">https://clinicaltrials.gov/search?id=%22NCT00012298%22</a>   |
| CHEMBL1201606 | IBRITUMOMAB TIUXETAN  | Antibody | B-lymphocyte antigen CD20 binding agent                     | Binding agent         | EFO_0000309   | Burkitts lymphoma                    | 1 Completed              | <a href="https://clinicaltrials.gov/search?id=%22NCT00064246%22">https://clinicaltrials.gov/search?id=%22NCT00064246%22</a>   |
| CHEMBL1201606 | IBRITUMOMAB TIUXETAN  | Antibody | B-lymphocyte antigen CD20 binding agent                     | Binding agent         | EFO_0000403   | diffuse large B-cell lymphoma        | 1 Terminated             | <a href="https://clinicaltrials.gov/search?id=%22NCT00036855%22">https://clinicaltrials.gov/search?id=%22NCT00036855%22</a>   |
| CHEMBL1201606 | IBRITUMOMAB TIUXETAN  | Antibody | B-lymphocyte antigen CD20 binding agent                     | Binding agent         | EFO_0000565   | leukemia                             | 1 Completed              | <a href="https://clinicaltrials.gov/search?id=%22NCT00048737%22">https://clinicaltrials.gov/search?id=%22NCT00048737%22</a>   |
| CHEMBL1201606 | IBRITUMOMAB TIUXETAN  | Antibody | B-lymphocyte antigen CD20 binding agent                     | Binding agent         | EFO_0000574   | lymphoma                             | 1 Terminated             | <a href="https://clinicaltrials.gov/search?id=%22NCT00372905%22">https://clinicaltrials.gov/search?id=%22NCT00372905%22</a>   |
| CHEMBL1201606 | IBRITUMOMAB TIUXETAN  | Antibody | B-lymphocyte antigen CD20 binding agent                     | Binding agent         | EFO_0001378   | multiple myeloma                     | 1 Completed              | <a href="https://clinicaltrials.gov/search?id=%22NCT00477815%22">https://clinicaltrials.gov/search?id=%22NCT00477815%22</a>   |

|               |                      |          |   |                     |               |   |   |                    |   |
|---------------|----------------------|----------|---|---------------------|---------------|---|---|--------------------|---|
| CHEMBL1201606 | IBRITUMOMAB TIUXETAN | Antibody | B-lymphocyte antigen CD20 binding agent   | Binding agent       | EFO_0005952   | non-Hodgkins lymphoma                   | 1 | Terminated         | <a href="https://clinicaltrials.gov/search?id=%22NCT00089284%22">https://clinicaltrials.gov/search?id=%22NCT00089284%22</a>   |
| CHEMBL1201606 | IBRITUMOMAB TIUXETAN | Antibody | B-lymphocyte antigen CD20 binding agent   | Binding agent       | EFO_0009441   | Waldenstrom macroglobulinemia           | 1 | Completed          | <a href="https://clinicaltrials.gov/search?id=%22NCT00438880%22">https://clinicaltrials.gov/search?id=%22NCT00438880%22</a> , <a href="https://clinicaltrials.gov/sea">https://clinicaltrials.gov/sea</a> |
| CHEMBL1201606 | IBRITUMOMAB TIUXETAN | Antibody | B-lymphocyte antigen CD20 binding agent   | Binding agent       | EFO_1000550   | Splenic Marginal Zone Lymphoma          | 1 | Terminated         | <a href="https://clinicaltrials.gov/search?id=%22NCT00012298%22">https://clinicaltrials.gov/search?id=%22NCT00012298%22</a>   |
| CHEMBL1201606 | IBRITUMOMAB TIUXETAN | Antibody | B-lymphocyte antigen CD20 binding agent   | Binding agent       | EFO_1001365   | Lymphoma, AIDS-Related                  | 1 | Terminated         | <a href="https://clinicaltrials.gov/search?id=%22NCT00036855%22">https://clinicaltrials.gov/search?id=%22NCT00036855%22</a>   |
| CHEMBL1201606 | IBRITUMOMAB TIUXETAN | Antibody | B-lymphocyte antigen CD20 binding agent   | Binding agent       | EFO_1001469   | Mantle cell lymphoma                    | 1 | Completed          | <a href="https://clinicaltrials.gov/search?id=%22NCT00438880%22">https://clinicaltrials.gov/search?id=%22NCT00438880%22</a>   |
| CHEMBL1201606 | IBRITUMOMAB TIUXETAN | Antibody | B-lymphocyte antigen CD20 binding agent   | Binding agent       | MONDO_0000873 | lymphoblastic lymphoma                  | 1 | Terminated         | <a href="https://clinicaltrials.gov/search?id=%22NCT00036855%22">https://clinicaltrials.gov/search?id=%22NCT00036855%22</a>   |
| CHEMBL1201606 | IBRITUMOMAB TIUXETAN | Antibody | B-lymphocyte antigen CD20 binding agent   | Binding agent       | MONDO_0018906 | follicular lymphoma                     | 1 | Completed          | <a href="https://clinicaltrials.gov/search?id=%22NCT00438880%22">https://clinicaltrials.gov/search?id=%22NCT00438880%22</a>   |
| CHEMBL1201606 | IBRITUMOMAB TIUXETAN | Antibody | B-lymphocyte antigen CD20 binding agent   | Binding agent       | MONDO_0019088 | post-transplant lymphoproliferative d   | 1 | Terminated         | <a href="https://clinicaltrials.gov/search?id=%22NCT00036855%22">https://clinicaltrials.gov/search?id=%22NCT00036855%22</a>   |
| CHEMBL1201606 | IBRITUMOMAB TIUXETAN | Antibody | B-lymphocyte antigen CD20 binding agent   | Binding agent       | MONDO_0019465 | nodal marginal zone B-cell lymphoma     | 1 | Completed          | <a href="https://clinicaltrials.gov/search?id=%22NCT00438880%22">https://clinicaltrials.gov/search?id=%22NCT00438880%22</a>   |
| CHEMBL2109330 | IC14                 | Antibody | Monocyte differentiation antigen CD14 inhibitor                                   | Inhibitor           | EFO_0005547   | dengue disease                          | 2 | Withdrawn          | <a href="https://clinicaltrials.gov/search?id=%22NCT03875560%22">https://clinicaltrials.gov/search?id=%22NCT03875560%22</a>   |
| CHEMBL2109330 | IC14                 | Antibody | Monocyte differentiation antigen CD14 inhibitor                                   | Inhibitor           | EFO_1000637   | acute respiratory distress syndrome     | 2 | Withdrawn          | <a href="https://clinicaltrials.gov/search?id=%22NCT03017547%22">https://clinicaltrials.gov/search?id=%22NCT03017547%22</a>   |
| CHEMBL2109330 | IC14                 | Antibody | Monocyte differentiation antigen CD14 inhibitor                                   | Inhibitor           | MONDO_0100096 | COVID-19                                | 2 | Recruiting         | <a href="https://clinicaltrials.gov/search?id=%22NCT04488081%22">https://clinicaltrials.gov/search?id=%22NCT04488081%22</a>   |
| CHEMBL2109330 | IC14                 | Antibody | Monocyte differentiation antigen CD14 inhibitor                                   | Inhibitor           | MONDO_0100130 | adult acute respiratory distress syndro | 2 | Terminated         | <a href="https://clinicaltrials.gov/search?id=%22NCT00233207%22">https://clinicaltrials.gov/search?id=%22NCT00233207%22</a>   |
| CHEMBL2109330 | IC14                 | Antibody | Monocyte differentiation antigen CD14 inhibitor                                   | Inhibitor           | EFO_0000253   | amyotrophic lateral sclerosis           | 1 | Completed          | <a href="https://clinicaltrials.gov/search?id=%22NCT03487263%22">https://clinicaltrials.gov/search?id=%22NCT03487263%22</a>   |
| CHEMBL2109389 | IMGATUZUMAB          | Antibody | Low affinity immunoglobulin gamma Fc region receptor III-A cr Cross-linking agent | Cross-linking agent | EFO_1001951   | colorectal carcinoma                    | 2 | Completed          | <a href="https://clinicaltrials.gov/search?id=%22NCT01326000%22">https://clinicaltrials.gov/search?id=%22NCT01326000%22</a>   |
| CHEMBL2109389 | IMGATUZUMAB          | Antibody | Low affinity immunoglobulin gamma Fc region receptor III-A cr Cross-linking agent | Cross-linking agent | EFO_0000616   | neoplasm                                | 1 | Completed          | <a href="https://clinicaltrials.gov/search?id=%22NCT00721266%22">https://clinicaltrials.gov/search?id=%22NCT00721266%22</a>   |
| CHEMBL2109389 | IMGATUZUMAB          | Antibody | Low affinity immunoglobulin gamma Fc region receptor III-A cr Cross-linking agent | Cross-linking agent | EFO_0003060   | non-small cell lung carcinoma           | 1 | Withdrawn          | <a href="https://clinicaltrials.gov/search?id=%22NCT01702714%22">https://clinicaltrials.gov/search?id=%22NCT01702714%22</a>   |
| CHEMBL2109389 | IMGATUZUMAB          | Antibody | Low affinity immunoglobulin gamma Fc region receptor III-A cr Cross-linking agent | Cross-linking agent | EFO_0006859   | head and neck malignant neoplasia       | 1 | Completed          | <a href="https://clinicaltrials.gov/search?id=%22NCT01046266%22">https://clinicaltrials.gov/search?id=%22NCT01046266%22</a>   |
| CHEMBL2109334 | INEBILIZUMAB         | Antibody | B-lymphocyte antigen CD19 binding agent   | Binding agent       | EFO_0000540   | immune system disease                   | 4 |                    | <a href="http://www.whocc.no/atc_ddd_index/?code=L04AA47">http://www.whocc.no/atc_ddd_index/?code=L04AA47</a>   |
| CHEMBL2109334 | INEBILIZUMAB         | Antibody | B-lymphocyte antigen CD19 binding agent   | Binding agent       | EFO_0004991   | Myasthenia gravis                       | 3 | Recruiting         | <a href="https://clinicaltrials.gov/search?id=%22NCT04524273%22">https://clinicaltrials.gov/search?id=%22NCT04524273%22</a>   |
| CHEMBL2109334 | INEBILIZUMAB         | Antibody | B-lymphocyte antigen CD19 binding agent   | Binding agent       | MONDO_0017287 | IgG4-related disease                    | 3 | Recruiting         | <a href="https://clinicaltrials.gov/search?id=%22NCT04540497%22">https://clinicaltrials.gov/search?id=%22NCT04540497%22</a>   |
| CHEMBL2109334 | INEBILIZUMAB         | Antibody | B-lymphocyte antigen CD19 binding agent   | Binding agent       | EFO_0000095   | chronic lymphocytic leukemia            | 2 | Completed          | <a href="https://clinicaltrials.gov/search?id=%22NCT01466153%22">https://clinicaltrials.gov/search?id=%22NCT01466153%22</a>   |
| CHEMBL2109334 | INEBILIZUMAB         | Antibody | B-lymphocyte antigen CD19 binding agent   | Binding agent       | EFO_0000403   | diffuse large B-cell lymphoma           | 2 | Completed          | <a href="https://clinicaltrials.gov/search?id=%22NCT01453205%22">https://clinicaltrials.gov/search?id=%22NCT01453205%22</a>   |
| CHEMBL2109334 | INEBILIZUMAB         | Antibody | B-lymphocyte antigen CD19 binding agent   | Binding agent       | EFO_0004256   | neuromyelitis optica                    | 2 | Completed          | <a href="https://clinicaltrials.gov/search?id=%22NCT02200770%22">https://clinicaltrials.gov/search?id=%22NCT02200770%22</a>   |
| CHEMBL2109334 | INEBILIZUMAB         | Antibody | B-lymphocyte antigen CD19 binding agent   | Binding agent       | EFO_0007332   | Japanese encephalitis                   | 2 | Not yet recruiting | <a href="https://clinicaltrials.gov/search?id=%22NCT04372615%22">https://clinicaltrials.gov/search?id=%22NCT04372615%22</a>   |
| CHEMBL2109334 | INEBILIZUMAB         | Antibody | B-lymphocyte antigen CD19 binding agent   | Binding agent       | EFO_0000311   | cancer                                  | 1 | Completed          | <a href="https://clinicaltrials.gov/search?id=%22NCT00983619%22">https://clinicaltrials.gov/search?id=%22NCT00983619%22</a> , <a href="https://clinicaltrials.gov/sea">https://clinicaltrials.gov/sea</a> |
| CHEMBL2109334 | INEBILIZUMAB         | Antibody | B-lymphocyte antigen CD19 binding agent   | Binding agent       | EFO_0000574   | lymphoma                                | 1 | Completed          | <a href="https://clinicaltrials.gov/search?id=%22NCT02271945%22">https://clinicaltrials.gov/search?id=%22NCT02271945%22</a>   |
| CHEMBL2109334 | INEBILIZUMAB         | Antibody | B-lymphocyte antigen CD19 binding agent   | Binding agent       | EFO_0001642   | lymphoid neoplasm                       | 1 | Completed          | <a href="https://clinicaltrials.gov/search?id=%22NCT01957579%22">https://clinicaltrials.gov/search?id=%22NCT01957579%22</a>   |
| CHEMBL2109334 | INEBILIZUMAB         | Antibody | B-lymphocyte antigen CD19 binding agent   | Binding agent       | EFO_0003885   | multiple sclerosis                      | 1 | Completed          | <a href="https://clinicaltrials.gov/search?id=%22NCT01585766%22">https://clinicaltrials.gov/search?id=%22NCT01585766%22</a>   |
| CHEMBL2109334 | INEBILIZUMAB         | Antibody | B-lymphocyte antigen CD19 binding agent   | Binding agent       | EFO_1001993   | scleroderma                             | 1 | Completed          | <a href="https://clinicaltrials.gov/search?id=%22NCT00946699%22">https://clinicaltrials.gov/search?id=%22NCT00946699%22</a>   |
| CHEMBL2109334 | INEBILIZUMAB         | Antibody | B-lymphocyte antigen CD19 binding agent   | Binding agent       | EFO_0001378   | multiple myeloma                        | 0 | Completed          | <a href="https://clinicaltrials.gov/search?id=%22NCT01861340%22">https://clinicaltrials.gov/search?id=%22NCT01861340%22</a>   |
| CHEMBL2108508 | INTERFERON ALFA-2A   | Protein  | Interferon alpha/beta receptor agonist  | Agonist             | EFO_0000220   | acute lymphoblastic leukemia            | 3 | Completed          | <a href="https://clinicaltrials.gov/search?id=%22NCT00483132%22">https://clinicaltrials.gov/search?id=%22NCT00483132%22</a>   |

|               |                    |         |  |         |               |                                     |                  |   |
|---------------|--------------------|---------|--|---------|---------------|-------------------------------------|------------------|---|
| CHEMBL2108508 | INTERFERON ALFA-2A | Protein | Interferon alpha/beta receptor agonist | Agonist | EFO_0000756   | melanoma                            | 3 Completed      | <a href="https://clinicaltrials.gov/search?id=%22NCT00204529%22">https://clinicaltrials.gov/search?id=%22NCT00204529%22</a>   |
| CHEMBL2108508 | INTERFERON ALFA-2A | Protein | Interferon alpha/beta receptor agonist | Agonist | EFO_0003047   | hepatitis C virus infection         | 3 Completed      | <a href="https://clinicaltrials.gov/search?id=%22NCT00381953%22">https://clinicaltrials.gov/search?id=%22NCT00381953%22</a>   |
| CHEMBL2108508 | INTERFERON ALFA-2A | Protein | Interferon alpha/beta receptor agonist | Agonist | EFO_0003780   | Behcet's syndrome                   | 3 Completed      | <a href="https://clinicaltrials.gov/search?id=%22NCT00167583%22">https://clinicaltrials.gov/search?id=%22NCT00167583%22</a>   |
| CHEMBL2108508 | INTERFERON ALFA-2A | Protein | Interferon alpha/beta receptor agonist | Agonist | EFO_1001156   | retinal vasculitis                  | 3 Completed      | <a href="https://clinicaltrials.gov/search?id=%22NCT00167583%22">https://clinicaltrials.gov/search?id=%22NCT00167583%22</a>   |
| CHEMBL2108508 | INTERFERON ALFA-2A | Protein | Interferon alpha/beta receptor agonist | Agonist | MONDO_0002367 | kidney cancer                       | 3 Completed      | <a href="https://clinicaltrials.gov/search?id=%22NCT00416429%22">https://clinicaltrials.gov/search?id=%22NCT00416429%22</a>   |
| CHEMBL2108508 | INTERFERON ALFA-2A | Protein | Interferon alpha/beta receptor agonist | Agonist | EFO_0000311   | cancer                              | 2 Terminated     | <a href="https://clinicaltrials.gov/search?id=%22NCT02159482%22">https://clinicaltrials.gov/search?id=%22NCT02159482%22</a>   |
| CHEMBL2108508 | INTERFERON ALFA-2A | Protein | Interferon alpha/beta receptor agonist | Agonist | EFO_0000574   | lymphoma                            | 2 Completed      | <a href="https://clinicaltrials.gov/search?id=%22NCT01404936%22">https://clinicaltrials.gov/search?id=%22NCT01404936%22</a>   |
| CHEMBL2108508 | INTERFERON ALFA-2A | Protein | Interferon alpha/beta receptor agonist | Agonist | EFO_0001378   | multiple myeloma                    | 2 Completed      | <a href="https://clinicaltrials.gov/search?id=%22NCT00323505%22">https://clinicaltrials.gov/search?id=%22NCT00323505%22</a>   |
| CHEMBL2108508 | INTERFERON ALFA-2A | Protein | Interferon alpha/beta receptor agonist | Agonist | EFO_0002617   | metastatic melanoma                 | 2 Completed      | <a href="https://clinicaltrials.gov/search?id=%22NCT00308607%22">https://clinicaltrials.gov/search?id=%22NCT00308607%22</a>   |
| CHEMBL2108508 | INTERFERON ALFA-2A | Protein | Interferon alpha/beta receptor agonist | Agonist | EFO_0004220   | chronic hepatitis C virus infection | 2 Completed      | <a href="https://clinicaltrials.gov/search?id=%22NCT02340962%22">https://clinicaltrials.gov/search?id=%22NCT02340962%22</a> , <a href="https://clinicaltrials.gov/sea">https://clinicaltrials.gov/sea</a> |
| CHEMBL2108508 | INTERFERON ALFA-2A | Protein | Interferon alpha/beta receptor agonist | Agonist | EFO_1000956   | hairy cell leukemia                 | 2 Completed      | <a href="https://clinicaltrials.gov/search?id=%22NCT00001567%22">https://clinicaltrials.gov/search?id=%22NCT00001567%22</a>   |
| CHEMBL2108508 | INTERFERON ALFA-2A | Protein | Interferon alpha/beta receptor agonist | Agonist | EFO_0000676   | psoriasis                           | 1 Completed      | <a href="https://clinicaltrials.gov/search?id=%22NCT02763969%22">https://clinicaltrials.gov/search?id=%22NCT02763969%22</a>   |
| CHEMBL2108508 | INTERFERON ALFA-2A | Protein | Interferon alpha/beta receptor agonist | Agonist | EFO_0000681   | renal cell carcinoma                | 1 Completed      | <a href="https://clinicaltrials.gov/search?id=%22NCT01513187%22">https://clinicaltrials.gov/search?id=%22NCT01513187%22</a>   |
| CHEMBL2108508 | INTERFERON ALFA-2A | Protein | Interferon alpha/beta receptor agonist | Agonist | EFO_0000764   | HIV infection                       | 1 Completed      | <a href="https://clinicaltrials.gov/search?id=%22NCT00000967%22">https://clinicaltrials.gov/search?id=%22NCT00000967%22</a> , <a href="https://clinicaltrials.gov/sea">https://clinicaltrials.gov/sea</a> |
| CHEMBL1201558 | INTERFERON ALFA-2B | Protein | Interferon alpha/beta receptor agonist | Agonist | EFO_0000558   | Kaposi's sarcoma                    | 4                | <a href="http://www.accessdata.fda.gov/drugsatfda_docs/label/2018/103132Orig1s51991bl.pdf">http://www.accessdata.fda.gov/drugsatfda_docs/label/2018/103132Orig1s51991bl.pdf</a>                           |
| CHEMBL1201558 | INTERFERON ALFA-2B | Protein | Interferon alpha/beta receptor agonist | Agonist | EFO_0000574   | lymphoma                            | 4 Terminated     | <a href="https://clinicaltrials.gov/search?id=%22NCT00854581%22">https://clinicaltrials.gov/search?id=%22NCT00854581%22</a>   |
| CHEMBL1201558 | INTERFERON ALFA-2B | Protein | Interferon alpha/beta receptor agonist | Agonist | EFO_0007147   | anogenital venereal wart            | 4                | <a href="http://www.accessdata.fda.gov/drugsatfda_docs/label/2018/103132Orig1s51991bl.pdf">http://www.accessdata.fda.gov/drugsatfda_docs/label/2018/103132Orig1s51991bl.pdf</a>                           |
| CHEMBL1201558 | INTERFERON ALFA-2B | Protein | Interferon alpha/beta receptor agonist | Agonist | EFO_0007306   | herpangina                          | 4 Completed      | <a href="https://clinicaltrials.gov/search?id=%22NCT03266601%22">https://clinicaltrials.gov/search?id=%22NCT03266601%22</a>   |
| CHEMBL1201558 | INTERFERON ALFA-2B | Protein | Interferon alpha/beta receptor agonist | Agonist | EFO_1000956   | hairy cell leukemia                 | 4                | <a href="http://www.accessdata.fda.gov/drugsatfda_docs/label/2018/103132Orig1s51991bl.pdf">http://www.accessdata.fda.gov/drugsatfda_docs/label/2018/103132Orig1s51991bl.pdf</a>                           |
| CHEMBL1201558 | INTERFERON ALFA-2B | Protein | Interferon alpha/beta receptor agonist | Agonist | EFO_1001051   | mycosis fungoides                   | 4 Unknown status | <a href="https://clinicaltrials.gov/search?id=%22NCT02323659%22">https://clinicaltrials.gov/search?id=%22NCT02323659%22</a>   |
| CHEMBL1201558 | INTERFERON ALFA-2B | Protein | Interferon alpha/beta receptor agonist | Agonist | MONDO_0018906 | follicular lymphoma                 | 4                | <a href="http://www.accessdata.fda.gov/drugsatfda_docs/label/2018/103132Orig1s51991bl.pdf">http://www.accessdata.fda.gov/drugsatfda_docs/label/2018/103132Orig1s51991bl.pdf</a>                           |
| CHEMBL1201558 | INTERFERON ALFA-2B | Protein | Interferon alpha/beta receptor agonist | Agonist | EFO_0000764   | HIV infection                       | 3 Terminated     | <a href="https://clinicaltrials.gov/search?id=%22NCT00125814%22">https://clinicaltrials.gov/search?id=%22NCT00125814%22</a>   |
| CHEMBL1201558 | INTERFERON ALFA-2B | Protein | Interferon alpha/beta receptor agonist | Agonist | EFO_0001378   | multiple myeloma                    | 3 Completed      | <a href="https://clinicaltrials.gov/search?id=%22NCT00002556%22">https://clinicaltrials.gov/search?id=%22NCT00002556%22</a> , <a href="https://clinicaltrials.gov/sea">https://clinicaltrials.gov/sea</a> |
| CHEMBL1201558 | INTERFERON ALFA-2B | Protein | Interferon alpha/beta receptor agonist | Agonist | EFO_0001422   | cirrhosis of liver                  | 3 Completed      | <a href="https://clinicaltrials.gov/search?id=%22NCT00273247%22">https://clinicaltrials.gov/search?id=%22NCT00273247%22</a>   |
| CHEMBL1201558 | INTERFERON ALFA-2B | Protein | Interferon alpha/beta receptor agonist | Agonist | EFO_0009708   | metastasis                          | 3 Completed      | <a href="https://clinicaltrials.gov/search?id=%22NCT00221702%22">https://clinicaltrials.gov/search?id=%22NCT00221702%22</a>   |
| CHEMBL1201558 | INTERFERON ALFA-2B | Protein | Interferon alpha/beta receptor agonist | Agonist | MONDO_0024503 | digestive system neuroendocrine neo | 3 Withdrawn      | <a href="https://clinicaltrials.gov/search?id=%22NCT01860742%22">https://clinicaltrials.gov/search?id=%22NCT01860742%22</a>   |
| CHEMBL1201558 | INTERFERON ALFA-2B | Protein | Interferon alpha/beta receptor agonist | Agonist | EFO_0000339   | chronic myelogenous leukemia        | 2 Recruiting     | <a href="https://clinicaltrials.gov/search?id=%22NCT02001818%22">https://clinicaltrials.gov/search?id=%22NCT02001818%22</a>   |
| CHEMBL1201558 | INTERFERON ALFA-2B | Protein | Interferon alpha/beta receptor agonist | Agonist | EFO_0000349   | clear cell renal carcinoma          | 2 Completed      | <a href="https://clinicaltrials.gov/search?id=%22NCT00101114%22">https://clinicaltrials.gov/search?id=%22NCT00101114%22</a> , <a href="https://clinicaltrials.gov/sea">https://clinicaltrials.gov/sea</a> |
| CHEMBL1201558 | INTERFERON ALFA-2B | Protein | Interferon alpha/beta receptor agonist | Agonist | EFO_0000673   | prostate adenocarcinoma             | 2 Recruiting     | <a href="https://clinicaltrials.gov/search?id=%22NCT03899987%22">https://clinicaltrials.gov/search?id=%22NCT03899987%22</a>   |
| CHEMBL1201558 | INTERFERON ALFA-2B | Protein | Interferon alpha/beta receptor agonist | Agonist | EFO_0000681   | renal cell carcinoma                | 2 Unknown status | <a href="https://clinicaltrials.gov/search?id=%22NCT01274273%22">https://clinicaltrials.gov/search?id=%22NCT01274273%22</a>   |
| CHEMBL1201558 | INTERFERON ALFA-2B | Protein | Interferon alpha/beta receptor agonist | Agonist | EFO_0001668   | human papilloma virus infection     | 2 Unknown status | <a href="https://clinicaltrials.gov/search?id=%22NCT02801383%22">https://clinicaltrials.gov/search?id=%22NCT02801383%22</a> , <a href="https://clinicaltrials.gov/sea">https://clinicaltrials.gov/sea</a> |
| CHEMBL1201558 | INTERFERON ALFA-2B | Protein | Interferon alpha/beta receptor agonist | Agonist | EFO_0002618   | pancreatic carcinoma                | 2 Completed      | <a href="https://clinicaltrials.gov/search?id=%22NCT00059826%22">https://clinicaltrials.gov/search?id=%22NCT00059826%22</a>   |



|               |                       |         |  |         |               |   |                          |   |
|---------------|-----------------------|---------|--|---------|---------------|---|--------------------------|---|
| CHEMBL1201558 | INTERFERON ALFA-2B    | Protein | Interferon alpha/beta receptor agonist | Agonist | EFO_0004239   | chronic hepatitis B virus infection     | 2 Completed              | <a href="https://clinicaltrials.gov/search?id=%22NCT00275938%22">https://clinicaltrials.gov/search?id=%22NCT00275938%22</a>   |
| CHEMBL1201558 | INTERFERON ALFA-2B    | Protein | Interferon alpha/beta receptor agonist | Agonist | MONDO_0000544 | mucosal melanoma                        | 2 Active, not recruiting | <a href="https://clinicaltrials.gov/search?id=%22NCT03178123%22">https://clinicaltrials.gov/search?id=%22NCT03178123%22</a>   |
| CHEMBL1201558 | INTERFERON ALFA-2B    | Protein | Interferon alpha/beta receptor agonist | Agonist | MONDO_0002367 | kidney cancer                           | 2 Withdrawn              | <a href="https://clinicaltrials.gov/search?id=%22NCT00293527%22">https://clinicaltrials.gov/search?id=%22NCT00293527%22</a>   |
| CHEMBL1201558 | INTERFERON ALFA-2B    | Protein | Interferon alpha/beta receptor agonist | Agonist | MONDO_0002691 | liver cancer                            | 2 Unknown status         | <a href="https://clinicaltrials.gov/search?id=%22NCT00471484%22">https://clinicaltrials.gov/search?id=%22NCT00471484%22</a>   |
| CHEMBL1201558 | INTERFERON ALFA-2B    | Protein | Interferon alpha/beta receptor agonist | Agonist | MONDO_0008315 | prostate cancer                         | 2 Terminated             | <a href="https://clinicaltrials.gov/search?id=%22NCT00176527%22">https://clinicaltrials.gov/search?id=%22NCT00176527%22</a>   |
| CHEMBL1201558 | INTERFERON ALFA-2B    | Protein | Interferon alpha/beta receptor agonist | Agonist | MONDO_0019471 | adult T-cell leukemia/lymphoma          | 2 Recruiting             | <a href="https://clinicaltrials.gov/search?id=%22NCT02737046%22">https://clinicaltrials.gov/search?id=%22NCT02737046%22</a>   |
| CHEMBL1201558 | INTERFERON ALFA-2B    | Protein | Interferon alpha/beta receptor agonist | Agonist | EFO_0000182   | hepatocellular carcinoma                | 1 Completed              | <a href="https://clinicaltrials.gov/search?id=%22NCT00234182%22">https://clinicaltrials.gov/search?id=%22NCT00234182%22</a>   |
| CHEMBL1201558 | INTERFERON ALFA-2B    | Protein | Interferon alpha/beta receptor agonist | Agonist | EFO_0000311   | cancer                                  | 1 Terminated             | <a href="https://clinicaltrials.gov/search?id=%22NCT00311558%22">https://clinicaltrials.gov/search?id=%22NCT00311558%22</a>   |
| CHEMBL1201558 | INTERFERON ALFA-2B    | Protein | Interferon alpha/beta receptor agonist | Agonist | EFO_0000389   | cutaneous melanoma                      | 1 Completed              | <a href="https://clinicaltrials.gov/search?id=%22NCT00398450%22">https://clinicaltrials.gov/search?id=%22NCT00398450%22</a>   |
| CHEMBL1201558 | INTERFERON ALFA-2B    | Protein | Interferon alpha/beta receptor agonist | Agonist | EFO_0000616   | neoplasm                                | 1 Completed              | <a href="https://clinicaltrials.gov/search?id=%22NCT00908869%22">https://clinicaltrials.gov/search?id=%22NCT00908869%22</a> , <a href="https://clinicaltrials.gov/sea">https://clinicaltrials.gov/sea</a> |
| CHEMBL1201558 | INTERFERON ALFA-2B    | Protein | Interferon alpha/beta receptor agonist | Agonist | EFO_0000756   | melanoma                                | 1 Terminated             | <a href="https://clinicaltrials.gov/search?id=%22NCT01409174%22">https://clinicaltrials.gov/search?id=%22NCT01409174%22</a>   |
| CHEMBL1201558 | INTERFERON ALFA-2B    | Protein | Interferon alpha/beta receptor agonist | Agonist | EFO_0003047   | hepatitis C virus infection             | 1 Completed              | <a href="https://clinicaltrials.gov/search?id=%22NCT01217359%22">https://clinicaltrials.gov/search?id=%22NCT01217359%22</a> , <a href="https://clinicaltrials.gov/sea">https://clinicaltrials.gov/sea</a> |
| CHEMBL1201558 | INTERFERON ALFA-2B    | Protein | Interferon alpha/beta receptor agonist | Agonist | EFO_0003869   | breast neoplasm                         | 1 Completed              | <a href="https://clinicaltrials.gov/search?id=%22NCT03066947%22">https://clinicaltrials.gov/search?id=%22NCT03066947%22</a>   |
| CHEMBL1201558 | INTERFERON ALFA-2B    | Protein | Interferon alpha/beta receptor agonist | Agonist | EFO_0004197   | hepatitis B virus infection             | 1 Completed              | <a href="https://clinicaltrials.gov/search?id=%22NCT03294798%22">https://clinicaltrials.gov/search?id=%22NCT03294798%22</a>   |
| CHEMBL1201558 | INTERFERON ALFA-2B    | Protein | Interferon alpha/beta receptor agonist | Agonist | EFO_0004220   | chronic hepatitis C virus infection     | 1 Completed              | <a href="https://clinicaltrials.gov/search?id=%22NCT01194037%22">https://clinicaltrials.gov/search?id=%22NCT01194037%22</a> , <a href="https://clinicaltrials.gov/sea">https://clinicaltrials.gov/sea</a> |
| CHEMBL1201558 | INTERFERON ALFA-2B    | Protein | Interferon alpha/beta receptor agonist | Agonist | MONDO_0004658 | breast carcinoma in situ                | 1 Recruiting             | <a href="https://clinicaltrials.gov/search?id=%22NCT04081389%22">https://clinicaltrials.gov/search?id=%22NCT04081389%22</a>   |
| CHEMBL1201558 | INTERFERON ALFA-2B    | Protein | Interferon alpha/beta receptor agonist | Agonist | MONDO_0008170 | ovarian cancer                          | 1 Completed              | <a href="https://clinicaltrials.gov/search?id=%22NCT01639885%22">https://clinicaltrials.gov/search?id=%22NCT01639885%22</a> , <a href="https://clinicaltrials.gov/sea">https://clinicaltrials.gov/sea</a> |
| CHEMBL1201558 | INTERFERON ALFA-2B    | Protein | Interferon alpha/beta receptor agonist | Agonist | MONDO_0044881 | hematopoietic and lymphoid cell neop    | 1 Recruiting             | <a href="https://clinicaltrials.gov/search?id=%22NCT04379518%22">https://clinicaltrials.gov/search?id=%22NCT04379518%22</a>   |
| CHEMBL1201558 | INTERFERON ALFA-2B    | Protein | Interferon alpha/beta receptor agonist | Agonist | EFO_0000565   | leukemia                                | 0 Completed              | <a href="https://clinicaltrials.gov/search?id=%22NCT02331706%22">https://clinicaltrials.gov/search?id=%22NCT02331706%22</a>   |
| CHEMBL1201558 | INTERFERON ALFA-2B    | Protein | Interferon alpha/beta receptor agonist | Agonist | MONDO_0007254 | breast cancer                           | 0 Active, not recruiting | <a href="https://clinicaltrials.gov/search?id=%22NCT03599453%22">https://clinicaltrials.gov/search?id=%22NCT03599453%22</a>   |
| CHEMBL1201558 | INTERFERON ALFA-2B    | Protein | Interferon alpha/beta receptor agonist | Agonist | MONDO_0100096 | COVID-19                                | 0 Not yet recruiting     | <a href="https://clinicaltrials.gov/search?id=%22NCT04293887%22">https://clinicaltrials.gov/search?id=%22NCT04293887%22</a>   |
| CHEMBL2109047 | INTERFERON ALFA-N3    | Protein | Interferon alpha/beta receptor agonist | Agonist | EFO_0000694   | severe acute respiratory syndrome       | 2 Completed              | <a href="https://clinicaltrials.gov/search?id=%22NCT00215826%22">https://clinicaltrials.gov/search?id=%22NCT00215826%22</a>   |
| CHEMBL2109047 | INTERFERON ALFA-N3    | Protein | Interferon alpha/beta receptor agonist | Agonist | EFO_0000764   | HIV infection                           | 1 Completed              | <a href="https://clinicaltrials.gov/search?id=%22NCT00002078%22">https://clinicaltrials.gov/search?id=%22NCT00002078%22</a>   |
| CHEMBL1201557 | INTERFERON ALFA-CON-1 | Protein | Interferon alpha/beta receptor agonist | Agonist | EFO_0003047   | hepatitis C virus infection             | 3 Completed              | <a href="https://clinicaltrials.gov/search?id=%22NCT00239252%22">https://clinicaltrials.gov/search?id=%22NCT00239252%22</a>   |
| CHEMBL1201557 | INTERFERON ALFA-CON-1 | Protein | Interferon alpha/beta receptor agonist | Agonist | EFO_0004220   | chronic hepatitis C virus infection     | 3 Completed              | <a href="https://clinicaltrials.gov/search?id=%22NCT00162734%22">https://clinicaltrials.gov/search?id=%22NCT00162734%22</a> , <a href="https://clinicaltrials.gov/sea">https://clinicaltrials.gov/sea</a> |
| CHEMBL1201557 | INTERFERON ALFA-CON-1 | Protein | Interferon alpha/beta receptor agonist | Agonist | EFO_0007328   | influenza                               | 1 Unknown status         | <a href="https://clinicaltrials.gov/search?id=%22NCT01227798%22">https://clinicaltrials.gov/search?id=%22NCT01227798%22</a>   |
| CHEMBL1201562 | INTERFERON BETA-1A    | Protein | Interferon alpha/beta receptor agonist | Agonist | EFO_0003106   | pneumonia                               | 4 Recruiting             | <a href="https://clinicaltrials.gov/search?id=%22NCT02735707%22">https://clinicaltrials.gov/search?id=%22NCT02735707%22</a>   |
| CHEMBL1201562 | INTERFERON BETA-1A    | Protein | Interferon alpha/beta receptor agonist | Agonist | EFO_0007328   | influenza                               | 4 Recruiting             | <a href="https://clinicaltrials.gov/search?id=%22NCT02735707%22">https://clinicaltrials.gov/search?id=%22NCT02735707%22</a>   |
| CHEMBL1201562 | INTERFERON BETA-1A    | Protein | Interferon alpha/beta receptor agonist | Agonist | EFO_0003047   | hepatitis C virus infection             | 3 Completed              | <a href="https://clinicaltrials.gov/search?id=%22NCT00249860%22">https://clinicaltrials.gov/search?id=%22NCT00249860%22</a>   |
| CHEMBL1201562 | INTERFERON BETA-1A    | Protein | Interferon alpha/beta receptor agonist | Agonist | MONDO_0100130 | adult acute respiratory distress syndro | 3 Terminated             | <a href="https://clinicaltrials.gov/search?id=%22NCT02622724%22">https://clinicaltrials.gov/search?id=%22NCT02622724%22</a>   |
| CHEMBL1201562 | INTERFERON BETA-1A    | Protein | Interferon alpha/beta receptor agonist | Agonist | EFO_0000249   | Alzheimer's disease                     | 2 Completed              | <a href="https://clinicaltrials.gov/search?id=%22NCT01075763%22">https://clinicaltrials.gov/search?id=%22NCT01075763%22</a>   |
| CHEMBL1201562 | INTERFERON BETA-1A    | Protein | Interferon alpha/beta receptor agonist | Agonist | EFO_0000270   | asthma                                  | 2 Completed              | <a href="https://clinicaltrials.gov/search?id=%22NCT01126177%22">https://clinicaltrials.gov/search?id=%22NCT01126177%22</a> , <a href="https://clinicaltrials.gov/sea">https://clinicaltrials.gov/sea</a> |

|               |                    |          |   |               |                |  |                          |   |
|---------------|--------------------|----------|---|---------------|----------------|--|--------------------------|---|
| CHEMBL1201562 | INTERFERON BETA-1A | Protein  | Interferon alpha/beta receptor agonist            | Agonist       | EFO_0000341    | chronic obstructive pulmonary disease  | 2 Recruiting             | <a href="https://clinicaltrials.gov/search?id=%22NCT03570359%22">https://clinicaltrials.gov/search?id=%22NCT03570359%22</a>   |
| CHEMBL1201562 | INTERFERON BETA-1A | Protein  | Interferon alpha/beta receptor agonist            | Agonist       | EFO_0000384    | Crohn's disease                        | 2 Terminated             | <a href="https://clinicaltrials.gov/search?id=%22NCT00304252%22">https://clinicaltrials.gov/search?id=%22NCT00304252%22</a>   |
| CHEMBL1201562 | INTERFERON BETA-1A | Protein  | Interferon alpha/beta receptor agonist            | Agonist       | EFO_0000729    | ulcerative colitis                     | 2 Completed              | <a href="https://clinicaltrials.gov/search?id=%22NCT00048347%22">https://clinicaltrials.gov/search?id=%22NCT00048347%22</a> , <a href="https://clinicaltrials.gov/sea">https://clinicaltrials.gov/sea</a> |
| CHEMBL1201562 | INTERFERON BETA-1A | Protein  | Interferon alpha/beta receptor agonist            | Agonist       | EFO_1000868    | chronic inflammatory demyelinating p   | 2 Completed              | <a href="https://clinicaltrials.gov/search?id=%22NCT00099489%22">https://clinicaltrials.gov/search?id=%22NCT00099489%22</a>   |
| CHEMBL1201562 | INTERFERON BETA-1A | Protein  | Interferon alpha/beta receptor agonist            | Agonist       | EFO_1001373    | Multiple Organ Failure                 | 2 Terminated             | <a href="https://clinicaltrials.gov/search?id=%22NCT03119701%22">https://clinicaltrials.gov/search?id=%22NCT03119701%22</a>   |
| CHEMBL1201562 | INTERFERON BETA-1A | Protein  | Interferon alpha/beta receptor agonist            | Agonist       | MONDO_0100096  | COVID-19                               | 2 Active, not recruiting | <a href="https://clinicaltrials.gov/search?id=%22NCT04385095%22">https://clinicaltrials.gov/search?id=%22NCT04385095%22</a>   |
| CHEMBL1201562 | INTERFERON BETA-1A | Protein  | Interferon alpha/beta receptor agonist            | Agonist       | EFO_0000712    | stroke                                 | 1 Completed              | <a href="https://clinicaltrials.gov/search?id=%22NCT00097318%22">https://clinicaltrials.gov/search?id=%22NCT00097318%22</a>   |
| CHEMBL1201562 | INTERFERON BETA-1A | Protein  | Interferon alpha/beta receptor agonist            | Agonist       | EFO_0003929    | relapsing-remitting multiple sclerosis | 1 Unknown status         | <a href="https://clinicaltrials.gov/search?id=%22NCT02364986%22">https://clinicaltrials.gov/search?id=%22NCT02364986%22</a>   |
| CHEMBL1201562 | INTERFERON BETA-1A | Protein  | Interferon alpha/beta receptor agonist            | Agonist       | EFO_0003885    | multiple sclerosis                     | 0 Completed              | <a href="https://clinicaltrials.gov/search?id=%22NCT00618527%22">https://clinicaltrials.gov/search?id=%22NCT00618527%22</a>   |
| CHEMBL1201563 | INTERFERON BETA-1B | Protein  | Interferon alpha/beta receptor agonist            | Agonist       | EFO_0000764    | HIV infection                          | 3 Completed              | <a href="https://clinicaltrials.gov/search?id=%22NCT00002238%22">https://clinicaltrials.gov/search?id=%22NCT00002238%22</a>   |
| CHEMBL1201563 | INTERFERON BETA-1B | Protein  | Interferon alpha/beta receptor agonist            | Agonist       | EFO_0000318    | cardiomyopathy                         | 2 Completed              | <a href="https://clinicaltrials.gov/search?id=%22NCT00185250%22">https://clinicaltrials.gov/search?id=%22NCT00185250%22</a>   |
| CHEMBL1201563 | INTERFERON BETA-1B | Protein  | Interferon alpha/beta receptor agonist            | Agonist       | EFO_0003929    | relapsing-remitting multiple sclerosis | 2 Recruiting             | <a href="https://clinicaltrials.gov/search?id=%22NCT03133403%22">https://clinicaltrials.gov/search?id=%22NCT03133403%22</a>   |
| CHEMBL1201563 | INTERFERON BETA-1B | Protein  | Interferon alpha/beta receptor agonist            | Agonist       | MONDO_0100096  | COVID-19                               | 2 Completed              | <a href="https://clinicaltrials.gov/search?id=%22NCT04343768%22">https://clinicaltrials.gov/search?id=%22NCT04343768%22</a> , <a href="https://clinicaltrials.gov/sea">https://clinicaltrials.gov/sea</a> |
| CHEMBL1201563 | INTERFERON BETA-1B | Protein  | Interferon alpha/beta receptor agonist            | Agonist       | MONDO_0100116  | Middle East respiratory syndrome       | 2 Completed              | <a href="https://clinicaltrials.gov/search?id=%22NCT02845843%22">https://clinicaltrials.gov/search?id=%22NCT02845843%22</a>   |
| CHEMBL1201563 | INTERFERON BETA-1B | Protein  | Interferon alpha/beta receptor agonist            | Agonist       | EFO_0003885    | multiple sclerosis                     | 1 Completed              | <a href="https://clinicaltrials.gov/search?id=%22NCT02474134%22">https://clinicaltrials.gov/search?id=%22NCT02474134%22</a>   |
| CHEMBL3545131 | ISATUXIMAB         | Antibody | Lymphocyte differentiation antigen CD38 inhibitor | Inhibitor     | EFO_0000203    | monoclonal gammopathy                  | 2 Not yet recruiting     | <a href="https://clinicaltrials.gov/search?id=%22NCT04614558%22">https://clinicaltrials.gov/search?id=%22NCT04614558%22</a>   |
| CHEMBL3545131 | ISATUXIMAB         | Antibody | Lymphocyte differentiation antigen CD38 inhibitor | Inhibitor     | EFO_0000220    | acute lymphoblastic leukemia           | 2 Recruiting             | <a href="https://clinicaltrials.gov/search?id=%22NCT03860844%22">https://clinicaltrials.gov/search?id=%22NCT03860844%22</a>   |
| CHEMBL3545131 | ISATUXIMAB         | Antibody | Lymphocyte differentiation antigen CD38 inhibitor | Inhibitor     | EFO_0000222    | acute myeloid leukemia                 | 2 Recruiting             | <a href="https://clinicaltrials.gov/search?id=%22NCT03860844%22">https://clinicaltrials.gov/search?id=%22NCT03860844%22</a>   |
| CHEMBL3545131 | ISATUXIMAB         | Antibody | Lymphocyte differentiation antigen CD38 inhibitor | Inhibitor     | EFO_0003073    | asymptomatic myeloma                   | 2 Recruiting             | <a href="https://clinicaltrials.gov/search?id=%22NCT02960555%22">https://clinicaltrials.gov/search?id=%22NCT02960555%22</a>   |
| CHEMBL3545131 | ISATUXIMAB         | Antibody | Lymphocyte differentiation antigen CD38 inhibitor | Inhibitor     | EFO_0005592    | T-cell leukemia                        | 2 Terminated             | <a href="https://clinicaltrials.gov/search?id=%22NCT02999633%22">https://clinicaltrials.gov/search?id=%22NCT02999633%22</a>   |
| CHEMBL3545131 | ISATUXIMAB         | Antibody | Lymphocyte differentiation antigen CD38 inhibitor | Inhibitor     | MONDO_0044917  | T-lymphoblastic lymphoma               | 2 Terminated             | <a href="https://clinicaltrials.gov/search?id=%22NCT02999633%22">https://clinicaltrials.gov/search?id=%22NCT02999633%22</a>   |
| CHEMBL3545131 | ISATUXIMAB         | Antibody | Lymphocyte differentiation antigen CD38 inhibitor | Inhibitor     | EFO_0000540    | immune system disease                  | 1 Recruiting             | <a href="https://clinicaltrials.gov/search?id=%22NCT04294459%22">https://clinicaltrials.gov/search?id=%22NCT04294459%22</a>   |
| CHEMBL3545131 | ISATUXIMAB         | Antibody | Lymphocyte differentiation antigen CD38 inhibitor | Inhibitor     | EFO_0000574    | lymphoma                               | 1 Active, not recruiting | <a href="https://clinicaltrials.gov/search?id=%22NCT03769181%22">https://clinicaltrials.gov/search?id=%22NCT03769181%22</a>   |
| CHEMBL3545131 | ISATUXIMAB         | Antibody | Lymphocyte differentiation antigen CD38 inhibitor | Inhibitor     | EFO_0000616    | neoplasm                               | 1 Active, not recruiting | <a href="https://clinicaltrials.gov/search?id=%22NCT03637764%22">https://clinicaltrials.gov/search?id=%22NCT03637764%22</a>   |
| CHEMBL3545131 | ISATUXIMAB         | Antibody | Lymphocyte differentiation antigen CD38 inhibitor | Inhibitor     | EFO_0001378    | multiple myeloma                       | 1 Active, not recruiting | <a href="https://clinicaltrials.gov/search?id=%22NCT02514668%22">https://clinicaltrials.gov/search?id=%22NCT02514668%22</a> , <a href="https://clinicaltrials.gov/sea">https://clinicaltrials.gov/sea</a> |
| CHEMBL3545131 | ISATUXIMAB         | Antibody | Lymphocyte differentiation antigen CD38 inhibitor | Inhibitor     | EFO_0001642    | lymphoid neoplasm                      | 1 Active, not recruiting | <a href="https://clinicaltrials.gov/search?id=%22NCT01084252%22">https://clinicaltrials.gov/search?id=%22NCT01084252%22</a>   |
| CHEMBL3545131 | ISATUXIMAB         | Antibody | Lymphocyte differentiation antigen CD38 inhibitor | Inhibitor     | EFO_1001264    | Anemia, Hemolytic, Autoimmune          | 1 Recruiting             | <a href="https://clinicaltrials.gov/search?id=%22NCT04661033%22">https://clinicaltrials.gov/search?id=%22NCT04661033%22</a>   |
| CHEMBL3545131 | ISATUXIMAB         | Antibody | Lymphocyte differentiation antigen CD38 inhibitor | Inhibitor     | EFO_1001951    | colorectal carcinoma                   | 1 Recruiting             | <a href="https://clinicaltrials.gov/search?id=%22NCT03555149%22">https://clinicaltrials.gov/search?id=%22NCT03555149%22</a>   |
| CHEMBL3545131 | ISATUXIMAB         | Antibody | Lymphocyte differentiation antigen CD38 inhibitor | Inhibitor     | Orphanet_85443 | AL amyloidosis                         | 1 Recruiting             | <a href="https://clinicaltrials.gov/search?id=%22NCT04754945%22">https://clinicaltrials.gov/search?id=%22NCT04754945%22</a>   |
| CHEMBL2109348 | LF6-R603           | Antibody | B-lymphocyte antigen CD20 binding agent           | Binding agent | EFO_0000095    | chronic lymphocytic leukemia           | 1 Completed              | <a href="https://clinicaltrials.gov/search?id=%22NCT01098188%22">https://clinicaltrials.gov/search?id=%22NCT01098188%22</a>   |
| CHEMBL2109150 | LINTUZUMAB         | Antibody | Myeloid cell surface antigen CD33 other           | Other         | MONDO_0001475  | neutropenia                            | 2 Completed              | <a href="https://clinicaltrials.gov/search?id=%22NCT00002800%22">https://clinicaltrials.gov/search?id=%22NCT00002800%22</a>   |
| CHEMBL2109150 | LINTUZUMAB         | Antibody | Myeloid cell surface antigen CD33 other           | Other         | EFO_0000198    | myelodysplastic syndrome               | 1 Completed              | <a href="https://clinicaltrials.gov/search?id=%22NCT00502112%22">https://clinicaltrials.gov/search?id=%22NCT00502112%22</a> , <a href="https://clinicaltrials.gov/sea">https://clinicaltrials.gov/sea</a> |

|               |                          |          |  |                     |               |                                     |   |                        |   |
|---------------|--------------------------|----------|--|---------------------|---------------|-------------------------------------|---|------------------------|---|
| CHEMBL2109150 | LINTUZUMAB               | Antibody | Myeloid cell surface antigen CD33 other                              | Other               | EFO_0000222   | acute myeloid leukemia              | 1 | Not yet recruiting     | <a href="https://clinicaltrials.gov/search?id=%22NCT03932318%22">https://clinicaltrials.gov/search?id=%22NCT03932318%22</a>   |
| CHEMBL2109150 | LINTUZUMAB               | Antibody | Myeloid cell surface antigen CD33 other                              | Other               | EFO_0000565   | leukemia                            | 1 | Active, not recruiting | <a href="https://clinicaltrials.gov/search?id=%22NCT01756677%22">https://clinicaltrials.gov/search?id=%22NCT01756677%22</a>   |
| CHEMBL2109150 | LINTUZUMAB               | Antibody | Myeloid cell surface antigen CD33 other                              | Other               | EFO_0001378   | multiple myeloma                    | 1 | Active, not recruiting | <a href="https://clinicaltrials.gov/search?id=%22NCT02998047%22">https://clinicaltrials.gov/search?id=%22NCT02998047%22</a>   |
| CHEMBL2109150 | LINTUZUMAB               | Antibody | Myeloid cell surface antigen CD33 other                              | Other               | EFO_1001779   | chronic myelomonocytic leukemia     | 1 | Completed              | <a href="https://clinicaltrials.gov/search?id=%22NCT00283114%22">https://clinicaltrials.gov/search?id=%22NCT00283114%22</a>   |
| CHEMBL4297236 | LISOCABTAGENE MARALEUCEL | Gene     | B-lymphocyte antigen CD19 binding agent                              | Binding agent       | EFO_0005952   | non-Hodgkins lymphoma               | 2 | Recruiting             | <a href="https://clinicaltrials.gov/search?id=%22NCT03484702%22">https://clinicaltrials.gov/search?id=%22NCT03484702%22</a> , <a href="https://clinicaltrials.gov/sea">https://clinicaltrials.gov/sea</a> |
| CHEMBL4297236 | LISOCABTAGENE MARALEUCEL | Gene     | B-lymphocyte antigen CD19 binding agent                              | Binding agent       | EFO_0000095   | chronic lymphocytic leukemia        | 1 | Recruiting             | <a href="https://clinicaltrials.gov/search?id=%22NCT03331198%22">https://clinicaltrials.gov/search?id=%22NCT03331198%22</a>   |
| CHEMBL4297236 | LISOCABTAGENE MARALEUCEL | Gene     | B-lymphocyte antigen CD19 binding agent                              | Binding agent       | EFO_0000220   | acute lymphoblastic leukemia        | 1 | Recruiting             | <a href="https://clinicaltrials.gov/search?id=%22NCT03743246%22">https://clinicaltrials.gov/search?id=%22NCT03743246%22</a>   |
| CHEMBL4297236 | LISOCABTAGENE MARALEUCEL | Gene     | B-lymphocyte antigen CD19 binding agent                              | Binding agent       | EFO_0000403   | diffuse large B-cell lymphoma       | 1 | Recruiting             | <a href="https://clinicaltrials.gov/search?id=%22NCT02631044%22">https://clinicaltrials.gov/search?id=%22NCT02631044%22</a> , <a href="https://clinicaltrials.gov/sea">https://clinicaltrials.gov/sea</a> |
| CHEMBL4297236 | LISOCABTAGENE MARALEUCEL | Gene     | B-lymphocyte antigen CD19 binding agent                              | Binding agent       | EFO_1001469   | Mantle cell lymphoma                | 1 | Recruiting             | <a href="https://clinicaltrials.gov/search?id=%22NCT02631044%22">https://clinicaltrials.gov/search?id=%22NCT02631044%22</a> , <a href="https://clinicaltrials.gov/sea">https://clinicaltrials.gov/sea</a> |
| CHEMBL4297236 | LISOCABTAGENE MARALEUCEL | Gene     | B-lymphocyte antigen CD19 binding agent                              | Binding agent       | MONDO_0018906 | follicular lymphoma                 | 1 | Recruiting             | <a href="https://clinicaltrials.gov/search?id=%22NCT02631044%22">https://clinicaltrials.gov/search?id=%22NCT02631044%22</a> , <a href="https://clinicaltrials.gov/sea">https://clinicaltrials.gov/sea</a> |
| CHEMBL4297778 | LONCASTUXIMAB TESIRINE   | Antibody | B-lymphocyte antigen CD19 binding agent                              | Binding agent       | EFO_1001938   | B-cell non-Hodgkins lymphoma        | 4 |                        | <a href="http://www.accessdata.fda.gov/drugsatfda_docs/label/2021/761196s000lbl.pdf">http://www.accessdata.fda.gov/drugsatfda_docs/label/2021/761196s000lbl.pdf</a>                                       |
| CHEMBL4297778 | LONCASTUXIMAB TESIRINE   | Antibody | B-lymphocyte antigen CD19 binding agent                              | Binding agent       | MONDO_0018906 | follicular lymphoma                 | 2 | Recruiting             | <a href="https://clinicaltrials.gov/search?id=%22NCT04699461%22">https://clinicaltrials.gov/search?id=%22NCT04699461%22</a>   |
| CHEMBL4297778 | LONCASTUXIMAB TESIRINE   | Antibody | B-lymphocyte antigen CD19 binding agent                              | Binding agent       | EFO_0000096   | neoplasm of mature B-cells          | 1 | Not yet recruiting     | <a href="https://clinicaltrials.gov/search?id=%22NCT04970901%22">https://clinicaltrials.gov/search?id=%22NCT04970901%22</a>   |
| CHEMBL4297778 | LONCASTUXIMAB TESIRINE   | Antibody | B-lymphocyte antigen CD19 binding agent                              | Binding agent       | EFO_0000220   | acute lymphoblastic leukemia        | 1 | Terminated             | <a href="https://clinicaltrials.gov/search?id=%22NCT02669264%22">https://clinicaltrials.gov/search?id=%22NCT02669264%22</a>   |
| CHEMBL4297778 | LONCASTUXIMAB TESIRINE   | Antibody | B-lymphocyte antigen CD19 binding agent                              | Binding agent       | EFO_0000403   | diffuse large B-cell lymphoma       | 1 | Not yet recruiting     | <a href="https://clinicaltrials.gov/search?id=%22NCT04974996%22">https://clinicaltrials.gov/search?id=%22NCT04974996%22</a>   |
| CHEMBL4594518 | LUTIKIZUMAB              | Antibody | Interleukin-1 beta inhibitor   | Inhibitor           | EFO_1000789   | osteoarthritis, hand                | 2 | Completed              | <a href="https://clinicaltrials.gov/search?id=%22NCT02384538%22">https://clinicaltrials.gov/search?id=%22NCT02384538%22</a>   |
| CHEMBL4594518 | LUTIKIZUMAB              | Antibody | Interleukin-1 beta inhibitor   | Inhibitor           | EFO_0002506   | osteoarthritis                      | 1 | Completed              | <a href="https://clinicaltrials.gov/search?id=%22NCT01668511%22">https://clinicaltrials.gov/search?id=%22NCT01668511%22</a>   |
| CHEMBL2109447 | LYM-1                    | Antibody | HLA class II histocompatibility antigen, DRB1-10 beta chain other    | Other               | EFO_0000574   | lymphoma                            | 1 | Unknown status         | <a href="https://clinicaltrials.gov/search?id=%22NCT00009776%22">https://clinicaltrials.gov/search?id=%22NCT00009776%22</a> , <a href="https://clinicaltrials.gov/sea">https://clinicaltrials.gov/sea</a> |
| CHEMBL2109267 | M195                     | Antibody | Myeloid cell surface antigen CD33 other                              | Other               | EFO_0000198   | myelodysplastic syndrome            | 1 | Completed              | <a href="https://clinicaltrials.gov/search?id=%22NCT00014495%22">https://clinicaltrials.gov/search?id=%22NCT00014495%22</a> , <a href="https://clinicaltrials.gov/sea">https://clinicaltrials.gov/sea</a> |
| CHEMBL2109267 | M195                     | Antibody | Myeloid cell surface antigen CD33 other                              | Other               | EFO_0000565   | leukemia                            | 1 | Completed              | <a href="https://clinicaltrials.gov/search?id=%22NCT00014495%22">https://clinicaltrials.gov/search?id=%22NCT00014495%22</a> , <a href="https://clinicaltrials.gov/sea">https://clinicaltrials.gov/sea</a> |
| CHEMBL2109267 | M195                     | Antibody | Myeloid cell surface antigen CD33 other                              | Other               | EFO_0004251   | myeloproliferative disorder         | 1 | Completed              | <a href="https://clinicaltrials.gov/search?id=%22NCT00014495%22">https://clinicaltrials.gov/search?id=%22NCT00014495%22</a> , <a href="https://clinicaltrials.gov/sea">https://clinicaltrials.gov/sea</a> |
| CHEMBL2109337 | MDX-1342                 | Antibody | B-lymphocyte antigen CD19 binding agent                              | Binding agent       | EFO_0000095   | chronic lymphocytic leukemia        | 1 | Completed              | <a href="https://clinicaltrials.gov/search?id=%22NCT00593944%22">https://clinicaltrials.gov/search?id=%22NCT00593944%22</a>   |
| CHEMBL2109337 | MDX-1342                 | Antibody | B-lymphocyte antigen CD19 binding agent                              | Binding agent       | EFO_0000685   | rheumatoid arthritis                | 1 | Completed              | <a href="https://clinicaltrials.gov/search?id=%22NCT00639834%22">https://clinicaltrials.gov/search?id=%22NCT00639834%22</a>   |
| CHEMBL2109391 | MDX-447                  | Antibody | High affinity immunoglobulin gamma Fc receptor I cross-linking agent | Cross-linking agent | EFO_1000158   | Central Nervous System Neoplasm     | 1 | Completed              | <a href="https://clinicaltrials.gov/search?id=%22NCT00005813%22">https://clinicaltrials.gov/search?id=%22NCT00005813%22</a>   |
| CHEMBL4297833 | MEZAGITAMAB              | Antibody | Lymphocyte differentiation antigen CD38 binding agent                | Binding agent       | EFO_0004991   | Myasthenia gravis                   | 2 | Recruiting             | <a href="https://clinicaltrials.gov/search?id=%22NCT04159805%22">https://clinicaltrials.gov/search?id=%22NCT04159805%22</a>   |
| CHEMBL4297833 | MEZAGITAMAB              | Antibody | Lymphocyte differentiation antigen CD38 binding agent                | Binding agent       | EFO_0007160   | autoimmune thrombocytopenic purpura | 2 | Recruiting             | <a href="https://clinicaltrials.gov/search?id=%22NCT04278924%22">https://clinicaltrials.gov/search?id=%22NCT04278924%22</a>   |
| CHEMBL4297833 | MEZAGITAMAB              | Antibody | Lymphocyte differentiation antigen CD38 binding agent                | Binding agent       | EFO_0001378   | multiple myeloma                    | 1 | Recruiting             | <a href="https://clinicaltrials.gov/search?id=%22NCT04776018%22">https://clinicaltrials.gov/search?id=%22NCT04776018%22</a>   |
| CHEMBL4297833 | MEZAGITAMAB              | Antibody | Lymphocyte differentiation antigen CD38 binding agent                | Binding agent       | EFO_0002690   | systemic lupus erythematosus        | 1 | Recruiting             | <a href="https://clinicaltrials.gov/search?id=%22NCT03724916%22">https://clinicaltrials.gov/search?id=%22NCT03724916%22</a>   |
| CHEMBL4297833 | MEZAGITAMAB              | Antibody | Lymphocyte differentiation antigen CD38 binding agent                | Binding agent       | EFO_0005140   | autoimmune disease                  | 1 | Completed              | <a href="https://clinicaltrials.gov/search?id=%22NCT02219256%22">https://clinicaltrials.gov/search?id=%22NCT02219256%22</a>   |
| CHEMBL4297789 | MT-3724                  | Unknown  | B-lymphocyte antigen CD20 binding agent                              | Binding agent       | EFO_0005952   | non-Hodgkins lymphoma               | 2 | Terminated             | <a href="https://clinicaltrials.gov/search?id=%22NCT03645395%22">https://clinicaltrials.gov/search?id=%22NCT03645395%22</a>   |
| CHEMBL4297789 | MT-3724                  | Unknown  | B-lymphocyte antigen CD20 binding agent                              | Binding agent       | EFO_0000095   | chronic lymphocytic leukemia        | 1 | Active, not recruiting | <a href="https://clinicaltrials.gov/search?id=%22NCT02361346%22">https://clinicaltrials.gov/search?id=%22NCT02361346%22</a>   |
| CHEMBL4297789 | MT-3724                  | Unknown  | B-lymphocyte antigen CD20 binding agent                              | Binding agent       | EFO_0000403   | diffuse large B-cell lymphoma       | 1 | Active, not recruiting | <a href="https://clinicaltrials.gov/search?id=%22NCT02361346%22">https://clinicaltrials.gov/search?id=%22NCT02361346%22</a>   |

|               |              |          |   |               |               |                                       |   |                        |   |
|---------------|--------------|----------|---|---------------|---------------|---------------------------------------|---|------------------------|---|
| CHEMBL4297789 | MT-3724      | Unknown  | B-lymphocyte antigen CD20 binding agent | Binding agent | EFO_0004289   | lymphoid leukemia                     | 1 | Withdrawn              | <a href="https://clinicaltrials.gov/search?id=%22NCT02556346%22">https://clinicaltrials.gov/search?id=%22NCT02556346%22</a>   |
| CHEMBL1743048 | OBINUTUZUMAB | Antibody | B-lymphocyte antigen CD20 binding agent | Binding agent | EFO_0002690   | systemic lupus erythematosus          | 3 | Not yet recruiting     | <a href="https://clinicaltrials.gov/search?id=%22NCT04963296%22">https://clinicaltrials.gov/search?id=%22NCT04963296%22</a>   |
| CHEMBL1743048 | OBINUTUZUMAB | Antibody | B-lymphocyte antigen CD20 binding agent | Binding agent | EFO_0003086   | kidney disease                        | 3 | Recruiting             | <a href="https://clinicaltrials.gov/search?id=%22NCT04629248%22">https://clinicaltrials.gov/search?id=%22NCT04629248%22</a>   |
| CHEMBL1743048 | OBINUTUZUMAB | Antibody | B-lymphocyte antigen CD20 binding agent | Binding agent | EFO_0000220   | acute lymphoblastic leukemia          | 2 | Not yet recruiting     | <a href="https://clinicaltrials.gov/search?id=%22NCT04920968%22">https://clinicaltrials.gov/search?id=%22NCT04920968%22</a>   |
| CHEMBL1743048 | OBINUTUZUMAB | Antibody | B-lymphocyte antigen CD20 binding agent | Binding agent | EFO_0003060   | non-small cell lung carcinoma         | 2 | Not yet recruiting     | <a href="https://clinicaltrials.gov/search?id=%22NCT04880863%22">https://clinicaltrials.gov/search?id=%22NCT04880863%22</a>   |
| CHEMBL1743048 | OBINUTUZUMAB | Antibody | B-lymphocyte antigen CD20 binding agent | Binding agent | EFO_0005761   | lupus nephritis                       | 2 | Active, not recruiting | <a href="https://clinicaltrials.gov/search?id=%22NCT02550652%22">https://clinicaltrials.gov/search?id=%22NCT02550652%22</a>   |
| CHEMBL1743048 | OBINUTUZUMAB | Antibody | B-lymphocyte antigen CD20 binding agent | Binding agent | EFO_0009441   | Waldenstrom macroglobulinemia         | 2 | Active, not recruiting | <a href="https://clinicaltrials.gov/search?id=%22NCT02962401%22">https://clinicaltrials.gov/search?id=%22NCT02962401%22</a>   |
| CHEMBL1743048 | OBINUTUZUMAB | Antibody | B-lymphocyte antigen CD20 binding agent | Binding agent | EFO_1000956   | hairy cell leukemia                   | 2 | Recruiting             | <a href="https://clinicaltrials.gov/search?id=%22NCT03410875%22">https://clinicaltrials.gov/search?id=%22NCT03410875%22</a>   |
| CHEMBL1743048 | OBINUTUZUMAB | Antibody | B-lymphocyte antigen CD20 binding agent | Binding agent | MONDO_0013730 | graft versus host disease             | 2 | Recruiting             | <a href="https://clinicaltrials.gov/search?id=%22NCT02867384%22">https://clinicaltrials.gov/search?id=%22NCT02867384%22</a>   |
| CHEMBL1743048 | OBINUTUZUMAB | Antibody | B-lymphocyte antigen CD20 binding agent | Binding agent | MONDO_0019088 | post-transplant lymphoproliferative d | 2 | Withdrawn              | <a href="https://clinicaltrials.gov/search?id=%22NCT03086395%22">https://clinicaltrials.gov/search?id=%22NCT03086395%22</a>   |
| CHEMBL1743048 | OBINUTUZUMAB | Antibody | B-lymphocyte antigen CD20 binding agent | Binding agent | EFO_0000095   | chronic lymphocytic leukemia          | 1 | Terminated             | <a href="https://clinicaltrials.gov/search?id=%22NCT02336048%22">https://clinicaltrials.gov/search?id=%22NCT02336048%22</a> , <a href="https://clinicaltrials.gov/sea">https://clinicaltrials.gov/sea</a> |
| CHEMBL1743048 | OBINUTUZUMAB | Antibody | B-lymphocyte antigen CD20 binding agent | Binding agent | EFO_0000096   | neoplasm of mature B-cells            | 1 | Active, not recruiting | <a href="https://clinicaltrials.gov/search?id=%22NCT04313608%22">https://clinicaltrials.gov/search?id=%22NCT04313608%22</a>   |
| CHEMBL1743048 | OBINUTUZUMAB | Antibody | B-lymphocyte antigen CD20 binding agent | Binding agent | EFO_0000183   | Hodgkins lymphoma                     | 1 | Suspended              | <a href="https://clinicaltrials.gov/search?id=%22NCT03432741%22">https://clinicaltrials.gov/search?id=%22NCT03432741%22</a>   |
| CHEMBL1743048 | OBINUTUZUMAB | Antibody | B-lymphocyte antigen CD20 binding agent | Binding agent | EFO_0000304   | breast adenocarcinoma                 | 1 | Suspended              | <a href="https://clinicaltrials.gov/search?id=%22NCT03432741%22">https://clinicaltrials.gov/search?id=%22NCT03432741%22</a>   |
| CHEMBL1743048 | OBINUTUZUMAB | Antibody | B-lymphocyte antigen CD20 binding agent | Binding agent | EFO_0000309   | Burkitts lymphoma                     | 1 | Recruiting             | <a href="https://clinicaltrials.gov/search?id=%22NCT03223610%22">https://clinicaltrials.gov/search?id=%22NCT03223610%22</a> , <a href="https://clinicaltrials.gov/sea">https://clinicaltrials.gov/sea</a> |
| CHEMBL1743048 | OBINUTUZUMAB | Antibody | B-lymphocyte antigen CD20 binding agent | Binding agent | EFO_0000311   | cancer                                | 1 | Active, not recruiting | <a href="https://clinicaltrials.gov/search?id=%22NCT02457598%22">https://clinicaltrials.gov/search?id=%22NCT02457598%22</a>   |
| CHEMBL1743048 | OBINUTUZUMAB | Antibody | B-lymphocyte antigen CD20 binding agent | Binding agent | EFO_0000403   | diffuse large B-cell lymphoma         | 1 | Recruiting             | <a href="https://clinicaltrials.gov/search?id=%22NCT03223610%22">https://clinicaltrials.gov/search?id=%22NCT03223610%22</a> , <a href="https://clinicaltrials.gov/sea">https://clinicaltrials.gov/sea</a> |
| CHEMBL1743048 | OBINUTUZUMAB | Antibody | B-lymphocyte antigen CD20 binding agent | Binding agent | EFO_0000565   | leukemia                              | 1 | Recruiting             | <a href="https://clinicaltrials.gov/search?id=%22NCT03759184%22">https://clinicaltrials.gov/search?id=%22NCT03759184%22</a>   |
| CHEMBL1743048 | OBINUTUZUMAB | Antibody | B-lymphocyte antigen CD20 binding agent | Binding agent | EFO_0000574   | lymphoma                              | 1 | Completed              | <a href="https://clinicaltrials.gov/search?id=%22NCT02729896%22">https://clinicaltrials.gov/search?id=%22NCT02729896%22</a> , <a href="https://clinicaltrials.gov/sea">https://clinicaltrials.gov/sea</a> |
| CHEMBL1743048 | OBINUTUZUMAB | Antibody | B-lymphocyte antigen CD20 binding agent | Binding agent | EFO_0000616   | neoplasm                              | 1 | Completed              | <a href="https://clinicaltrials.gov/search?id=%22NCT02324257%22">https://clinicaltrials.gov/search?id=%22NCT02324257%22</a>   |
| CHEMBL1743048 | OBINUTUZUMAB | Antibody | B-lymphocyte antigen CD20 binding agent | Binding agent | EFO_0003884   | chronic kidney disease                | 1 | Completed              | <a href="https://clinicaltrials.gov/search?id=%22NCT02586051%22">https://clinicaltrials.gov/search?id=%22NCT02586051%22</a>   |
| CHEMBL1743048 | OBINUTUZUMAB | Antibody | B-lymphocyte antigen CD20 binding agent | Binding agent | EFO_0005952   | non-Hodgkins lymphoma                 | 1 | Recruiting             | <a href="https://clinicaltrials.gov/search?id=%22NCT04434196%22">https://clinicaltrials.gov/search?id=%22NCT04434196%22</a> , <a href="https://clinicaltrials.gov/sea">https://clinicaltrials.gov/sea</a> |
| CHEMBL1743048 | OBINUTUZUMAB | Antibody | B-lymphocyte antigen CD20 binding agent | Binding agent | EFO_1001051   | mycosis fungoides                     | 1 | Suspended              | <a href="https://clinicaltrials.gov/search?id=%22NCT03432741%22">https://clinicaltrials.gov/search?id=%22NCT03432741%22</a>   |
| CHEMBL1743048 | OBINUTUZUMAB | Antibody | B-lymphocyte antigen CD20 binding agent | Binding agent | EFO_1001469   | Mantle cell lymphoma                  | 1 | Active, not recruiting | <a href="https://clinicaltrials.gov/search?id=%22NCT02558816%22">https://clinicaltrials.gov/search?id=%22NCT02558816%22</a>   |
| CHEMBL1743048 | OBINUTUZUMAB | Antibody | B-lymphocyte antigen CD20 binding agent | Binding agent | EFO_1001480   | metastatic colorectal cancer          | 1 | Recruiting             | <a href="https://clinicaltrials.gov/search?id=%22NCT04826003%22">https://clinicaltrials.gov/search?id=%22NCT04826003%22</a>   |
| CHEMBL1743048 | OBINUTUZUMAB | Antibody | B-lymphocyte antigen CD20 binding agent | Binding agent | EFO_1001951   | colorectal carcinoma                  | 1 | Recruiting             | <a href="https://clinicaltrials.gov/search?id=%22NCT03866239%22">https://clinicaltrials.gov/search?id=%22NCT03866239%22</a>   |
| CHEMBL1743048 | OBINUTUZUMAB | Antibody | B-lymphocyte antigen CD20 binding agent | Binding agent | MONDO_0001023 | prolymphocytic leukemia               | 1 | Active, not recruiting | <a href="https://clinicaltrials.gov/search?id=%22NCT02296918%22">https://clinicaltrials.gov/search?id=%22NCT02296918%22</a>   |
| CHEMBL1743048 | OBINUTUZUMAB | Antibody | B-lymphocyte antigen CD20 binding agent | Binding agent | MONDO_0002083 | Richter syndrome                      | 1 | Active, not recruiting | <a href="https://clinicaltrials.gov/search?id=%22NCT03113695%22">https://clinicaltrials.gov/search?id=%22NCT03113695%22</a>   |
| CHEMBL1743048 | OBINUTUZUMAB | Antibody | B-lymphocyte antigen CD20 binding agent | Binding agent | MONDO_0018906 | follicular lymphoma                   | 1 | Completed              | <a href="https://clinicaltrials.gov/search?id=%22NCT02631577%22">https://clinicaltrials.gov/search?id=%22NCT02631577%22</a> , <a href="https://clinicaltrials.gov/sea">https://clinicaltrials.gov/sea</a> |
| CHEMBL1743048 | OBINUTUZUMAB | Antibody | B-lymphocyte antigen CD20 binding agent | Binding agent | MONDO_0019465 | nodal marginal zone B-cell lymphoma   | 1 | Suspended              | <a href="https://clinicaltrials.gov/search?id=%22NCT03432741%22">https://clinicaltrials.gov/search?id=%22NCT03432741%22</a>   |
| CHEMBL2109665 | OCARATUZUMAB | Antibody | B-lymphocyte antigen CD20 binding agent | Binding agent | EFO_0000311   | cancer                                | 1 | Unknown status         | <a href="https://clinicaltrials.gov/search?id=%22NCT01858181%22">https://clinicaltrials.gov/search?id=%22NCT01858181%22</a>   |
| CHEMBL2108041 | OCRELIZUMAB  | Antibody | B-lymphocyte antigen CD20 binding agent | Binding agent | EFO_0000540   | immune system disease                 | 4 |                        | <a href="http://www.whocc.no/atc_ddd_index/?code=L04AA36">http://www.whocc.no/atc_ddd_index/?code=L04AA36</a>   |

|               |              |          |   |               |               |  |   |                        |   |
|---------------|--------------|----------|---|---------------|---------------|--|---|------------------------|---|
| CHEMBL2108041 | OCRELIZUMAB  | Antibody | B-lymphocyte antigen CD20 binding agent | Binding agent | EFO_0008522   | secondary progressive multiple sclero: | 4 | Not yet recruiting     | <a href="https://clinicaltrials.gov/search?id=%22NCT04925557%22">https://clinicaltrials.gov/search?id=%22NCT04925557%22</a>   |
| CHEMBL2108041 | OCRELIZUMAB  | Antibody | B-lymphocyte antigen CD20 binding agent | Binding agent | EFO_0002690   | systemic lupus erythematosus           | 3 | Terminated             | <a href="https://clinicaltrials.gov/search?id=%22NCT00539838%22">https://clinicaltrials.gov/search?id=%22NCT00539838%22</a>   |
| CHEMBL2108041 | OCRELIZUMAB  | Antibody | B-lymphocyte antigen CD20 binding agent | Binding agent | EFO_0003840   | chronic progressive multiple sclerosis | 3 | Active, not recruiting | <a href="https://clinicaltrials.gov/search?id=%22NCT01194570%22">https://clinicaltrials.gov/search?id=%22NCT01194570%22</a>   |
| CHEMBL2108041 | OCRELIZUMAB  | Antibody | B-lymphocyte antigen CD20 binding agent | Binding agent | EFO_0008520   | primary progressive multiple sclerosis | 3 | Recruiting             | <a href="https://clinicaltrials.gov/search?id=%22NCT03691077%22">https://clinicaltrials.gov/search?id=%22NCT03691077%22</a>   |
| CHEMBL2108041 | OCRELIZUMAB  | Antibody | B-lymphocyte antigen CD20 binding agent | Binding agent | EFO_0003929   | relapsing-remitting multiple sclerosis | 2 | Not yet recruiting     | <a href="https://clinicaltrials.gov/search?id=%22NCT04971005%22">https://clinicaltrials.gov/search?id=%22NCT04971005%22</a>   |
| CHEMBL2108041 | OCRELIZUMAB  | Antibody | B-lymphocyte antigen CD20 binding agent | Binding agent | EFO_0007332   | Japanese encephalitis                  | 2 | Completed              | <a href="https://clinicaltrials.gov/search?id=%22NCT03835728%22">https://clinicaltrials.gov/search?id=%22NCT03835728%22</a>   |
| CHEMBL2108041 | OCRELIZUMAB  | Antibody | B-lymphocyte antigen CD20 binding agent | Binding agent | EFO_0000685   | rheumatoid arthritis                   | 1 | Terminated             | <a href="https://clinicaltrials.gov/search?id=%22NCT02720120%22">https://clinicaltrials.gov/search?id=%22NCT02720120%22</a>   |
| CHEMBL2108041 | OCRELIZUMAB  | Antibody | B-lymphocyte antigen CD20 binding agent | Binding agent | EFO_0003885   | multiple sclerosis                     | 1 | Recruiting             | <a href="https://clinicaltrials.gov/search?id=%22NCT03972306%22">https://clinicaltrials.gov/search?id=%22NCT03972306%22</a>   |
| CHEMBL2108041 | OCRELIZUMAB  | Antibody | B-lymphocyte antigen CD20 binding agent | Binding agent | EFO_0005952   | non-Hodgkins lymphoma                  | 1 | Completed              | <a href="https://clinicaltrials.gov/search?id=%22NCT02723071%22">https://clinicaltrials.gov/search?id=%22NCT02723071%22</a>   |
| CHEMBL4298084 | ODRONEXTAMAB | Antibody | B-lymphocyte antigen CD20 binding agent | Binding agent | EFO_0000096   | neoplasm of mature B-cells             | 2 | Recruiting             | <a href="https://clinicaltrials.gov/search?id=%22NCT03888105%22">https://clinicaltrials.gov/search?id=%22NCT03888105%22</a>   |
| CHEMBL4298084 | ODRONEXTAMAB | Antibody | B-lymphocyte antigen CD20 binding agent | Binding agent | EFO_0000095   | chronic lymphocytic leukemia           | 1 | Recruiting             | <a href="https://clinicaltrials.gov/search?id=%22NCT02290951%22">https://clinicaltrials.gov/search?id=%22NCT02290951%22</a>   |
| CHEMBL4298084 | ODRONEXTAMAB | Antibody | B-lymphocyte antigen CD20 binding agent | Binding agent | EFO_0000574   | lymphoma                               | 1 | Active, not recruiting | <a href="https://clinicaltrials.gov/search?id=%22NCT02651662%22">https://clinicaltrials.gov/search?id=%22NCT02651662%22</a>   |
| CHEMBL1201836 | OFATUMUMAB   | Antibody | B-lymphocyte antigen CD20 binding agent | Binding agent | EFO_0000616   | neoplasm                               | 4 |                        | <a href="http://www.whocc.no/atc_ddd_index/?code=L01XC10">http://www.whocc.no/atc_ddd_index/?code=L01XC10</a>   |
| CHEMBL1201836 | OFATUMUMAB   | Antibody | B-lymphocyte antigen CD20 binding agent | Binding agent | EFO_0004719   | pemphigus vulgaris                     | 3 | Terminated             | <a href="https://clinicaltrials.gov/search?id=%22NCT01920477%22">https://clinicaltrials.gov/search?id=%22NCT01920477%22</a>   |
| CHEMBL1201836 | OFATUMUMAB   | Antibody | B-lymphocyte antigen CD20 binding agent | Binding agent | EFO_1000749   | pemphigus                              | 3 | Terminated             | <a href="https://clinicaltrials.gov/search?id=%22NCT02613910%22">https://clinicaltrials.gov/search?id=%22NCT02613910%22</a>   |
| CHEMBL1201836 | OFATUMUMAB   | Antibody | B-lymphocyte antigen CD20 binding agent | Binding agent | EFO_0000183   | Hodgkins lymphoma                      | 2 | Completed              | <a href="https://clinicaltrials.gov/search?id=%22NCT01195766%22">https://clinicaltrials.gov/search?id=%22NCT01195766%22</a>   |
| CHEMBL1201836 | OFATUMUMAB   | Antibody | B-lymphocyte antigen CD20 binding agent | Binding agent | EFO_0000220   | acute lymphoblastic leukemia           | 2 | Terminated             | <a href="https://clinicaltrials.gov/search?id=%22NCT03488225%22">https://clinicaltrials.gov/search?id=%22NCT03488225%22</a>   |
| CHEMBL1201836 | OFATUMUMAB   | Antibody | B-lymphocyte antigen CD20 binding agent | Binding agent | EFO_0000309   | Burkitts lymphoma                      | 2 | Completed              | <a href="https://clinicaltrials.gov/search?id=%22NCT01363128%22">https://clinicaltrials.gov/search?id=%22NCT01363128%22</a>   |
| CHEMBL1201836 | OFATUMUMAB   | Antibody | B-lymphocyte antigen CD20 binding agent | Binding agent | EFO_0000403   | diffuse large B-cell lymphoma          | 2 | Completed              | <a href="https://clinicaltrials.gov/search?id=%22NCT01481272%22">https://clinicaltrials.gov/search?id=%22NCT01481272%22</a> , <a href="https://clinicaltrials.gov/sea">https://clinicaltrials.gov/sea</a> |
| CHEMBL1201836 | OFATUMUMAB   | Antibody | B-lymphocyte antigen CD20 binding agent | Binding agent | EFO_0000574   | lymphoma                               | 2 | Completed              | <a href="https://clinicaltrials.gov/search?id=%22NCT01613300%22">https://clinicaltrials.gov/search?id=%22NCT01613300%22</a> , <a href="https://clinicaltrials.gov/sea">https://clinicaltrials.gov/sea</a> |
| CHEMBL1201836 | OFATUMUMAB   | Antibody | B-lymphocyte antigen CD20 binding agent | Binding agent | EFO_0000756   | melanoma                               | 2 | Completed              | <a href="https://clinicaltrials.gov/search?id=%22NCT01376713%22">https://clinicaltrials.gov/search?id=%22NCT01376713%22</a>   |
| CHEMBL1201836 | OFATUMUMAB   | Antibody | B-lymphocyte antigen CD20 binding agent | Binding agent | EFO_0000765   | AIDS                                   | 2 | Recruiting             | <a href="https://clinicaltrials.gov/search?id=%22NCT02199184%22">https://clinicaltrials.gov/search?id=%22NCT02199184%22</a>   |
| CHEMBL1201836 | OFATUMUMAB   | Antibody | B-lymphocyte antigen CD20 binding agent | Binding agent | EFO_0003885   | multiple sclerosis                     | 2 | Completed              | <a href="https://clinicaltrials.gov/search?id=%22NCT03560739%22">https://clinicaltrials.gov/search?id=%22NCT03560739%22</a> , <a href="https://clinicaltrials.gov/sea">https://clinicaltrials.gov/sea</a> |
| CHEMBL1201836 | OFATUMUMAB   | Antibody | B-lymphocyte antigen CD20 binding agent | Binding agent | EFO_0004255   | nephrotic syndrome                     | 2 | Completed              | <a href="https://clinicaltrials.gov/search?id=%22NCT02394119%22">https://clinicaltrials.gov/search?id=%22NCT02394119%22</a>   |
| CHEMBL1201836 | OFATUMUMAB   | Antibody | B-lymphocyte antigen CD20 binding agent | Binding agent | EFO_0004289   | lymphoid leukemia                      | 2 | Completed              | <a href="https://clinicaltrials.gov/search?id=%22NCT01762202%22">https://clinicaltrials.gov/search?id=%22NCT01762202%22</a>   |
| CHEMBL1201836 | OFATUMUMAB   | Antibody | B-lymphocyte antigen CD20 binding agent | Binding agent | EFO_0009441   | Waldenstrom macroglobulinemia          | 2 | Terminated             | <a href="https://clinicaltrials.gov/search?id=%22NCT01536067%22">https://clinicaltrials.gov/search?id=%22NCT01536067%22</a>   |
| CHEMBL1201836 | OFATUMUMAB   | Antibody | B-lymphocyte antigen CD20 binding agent | Binding agent | MONDO_0000870 | childhood acute lymphoblastic leuker   | 2 | Completed              | <a href="https://clinicaltrials.gov/search?id=%22NCT01363128%22">https://clinicaltrials.gov/search?id=%22NCT01363128%22</a>   |
| CHEMBL1201836 | OFATUMUMAB   | Antibody | B-lymphocyte antigen CD20 binding agent | Binding agent | MONDO_0000873 | lymphoblastic lymphoma                 | 2 | Completed              | <a href="https://clinicaltrials.gov/search?id=%22NCT01363128%22">https://clinicaltrials.gov/search?id=%22NCT01363128%22</a>   |
| CHEMBL1201836 | OFATUMUMAB   | Antibody | B-lymphocyte antigen CD20 binding agent | Binding agent | MONDO_0003541 | adult acute lymphoblastic leukemia     | 2 | Completed              | <a href="https://clinicaltrials.gov/search?id=%22NCT01363128%22">https://clinicaltrials.gov/search?id=%22NCT01363128%22</a>   |
| CHEMBL1201836 | OFATUMUMAB   | Antibody | B-lymphocyte antigen CD20 binding agent | Binding agent | EFO_0000095   | chronic lymphocytic leukemia           | 1 | Completed              | <a href="https://clinicaltrials.gov/search?id=%22NCT00742144%22">https://clinicaltrials.gov/search?id=%22NCT00742144%22</a> , <a href="https://clinicaltrials.gov/sea">https://clinicaltrials.gov/sea</a> |
| CHEMBL1201836 | OFATUMUMAB   | Antibody | B-lymphocyte antigen CD20 binding agent | Binding agent | EFO_0000311   | cancer                                 | 1 | Completed              | <a href="https://clinicaltrials.gov/search?id=%22NCT01691807%22">https://clinicaltrials.gov/search?id=%22NCT01691807%22</a>   |
| CHEMBL1201836 | OFATUMUMAB   | Antibody | B-lymphocyte antigen CD20 binding agent | Binding agent | EFO_0000565   | leukemia                               | 1 | Completed              | <a href="https://clinicaltrials.gov/search?id=%22NCT01110031%22">https://clinicaltrials.gov/search?id=%22NCT01110031%22</a>   |

|               |                       |          |   |               |               |                                  |                          |   |
|---------------|-----------------------|----------|---|---------------|---------------|----------------------------------|--------------------------|---|
| CHEMBL1201836 | OFATUMUMAB            | Antibody | B-lymphocyte antigen CD20 binding agent | Binding agent | EFO_0000685   | rheumatoid arthritis             | 1 Completed              | <a href="https://clinicaltrials.gov/search?id=%22NCT00686868%22">https://clinicaltrials.gov/search?id=%22NCT00686868%22</a>   |
| CHEMBL1201836 | OFATUMUMAB            | Antibody | B-lymphocyte antigen CD20 binding agent | Binding agent | EFO_0005952   | non-Hodgkins lymphoma            | 1 Active, not recruiting | <a href="https://clinicaltrials.gov/search?id=%22NCT01458366%22">https://clinicaltrials.gov/search?id=%22NCT01458366%22</a>   |
| CHEMBL1201836 | OFATUMUMAB            | Antibody | B-lymphocyte antigen CD20 binding agent | Binding agent | EFO_1001469   | Mantle cell lymphoma             | 1 Unknown status         | <a href="https://clinicaltrials.gov/search?id=%22NCT01221103%22">https://clinicaltrials.gov/search?id=%22NCT01221103%22</a>   |
| CHEMBL1201836 | OFATUMUMAB            | Antibody | B-lymphocyte antigen CD20 binding agent | Binding agent | MONDO_0001023 | prolymphocytic leukemia          | 1 Completed              | <a href="https://clinicaltrials.gov/search?id=%22NCT01515176%22">https://clinicaltrials.gov/search?id=%22NCT01515176%22</a>   |
| CHEMBL1201836 | OFATUMUMAB            | Antibody | B-lymphocyte antigen CD20 binding agent | Binding agent | MONDO_0002083 | Richter syndrome                 | 1 Completed              | <a href="https://clinicaltrials.gov/search?id=%22NCT01217749%22">https://clinicaltrials.gov/search?id=%22NCT01217749%22</a>   |
| CHEMBL1201836 | OFATUMUMAB            | Antibody | B-lymphocyte antigen CD20 binding agent | Binding agent | MONDO_0013730 | graft versus host disease        | 1 Active, not recruiting | <a href="https://clinicaltrials.gov/search?id=%22NCT01680965%22">https://clinicaltrials.gov/search?id=%22NCT01680965%22</a>   |
| CHEMBL1201836 | OFATUMUMAB            | Antibody | B-lymphocyte antigen CD20 binding agent | Binding agent | MONDO_0018906 | follicular lymphoma              | 1 Withdrawn              | <a href="https://clinicaltrials.gov/search?id=%22NCT00092274%22">https://clinicaltrials.gov/search?id=%22NCT00092274%22</a>   |
| CHEMBL1201560 | PEGINTERFERON ALFA-2A | Protein  | Interferon alpha/beta receptor agonist  | Agonist       | EFO_0004272   | anemia (phenotype)               | 4 Completed              | <a href="https://clinicaltrials.gov/search?id=%22NCT00560274%22">https://clinicaltrials.gov/search?id=%22NCT00560274%22</a>   |
| CHEMBL1201560 | PEGINTERFERON ALFA-2A | Protein  | Interferon alpha/beta receptor agonist  | Agonist       | EFO_0008496   | chronic hepatitis                | 4 Recruiting             | <a href="https://clinicaltrials.gov/search?id=%22NCT03013556%22">https://clinicaltrials.gov/search?id=%22NCT03013556%22</a>   |
| CHEMBL1201560 | PEGINTERFERON ALFA-2A | Protein  | Interferon alpha/beta receptor agonist  | Agonist       | EFO_0000756   | melanoma                         | 3 Completed              | <a href="https://clinicaltrials.gov/search?id=%22NCT00204529%22">https://clinicaltrials.gov/search?id=%22NCT00204529%22</a>   |
| CHEMBL1201560 | PEGINTERFERON ALFA-2A | Protein  | Interferon alpha/beta receptor agonist  | Agonist       | EFO_0001422   | cirrhosis of liver               | 3 Completed              | <a href="https://clinicaltrials.gov/search?id=%22NCT00006164%22">https://clinicaltrials.gov/search?id=%22NCT00006164%22</a>   |
| CHEMBL1201560 | PEGINTERFERON ALFA-2A | Protein  | Interferon alpha/beta receptor agonist  | Agonist       | EFO_0002430   | primary myelofibrosis            | 3 Unknown status         | <a href="https://clinicaltrials.gov/search?id=%22NCT01387763%22">https://clinicaltrials.gov/search?id=%22NCT01387763%22</a>   |
| CHEMBL1201560 | PEGINTERFERON ALFA-2A | Protein  | Interferon alpha/beta receptor agonist  | Agonist       | HP_0012115    | Hepatitis                        | 3 Completed              | <a href="https://clinicaltrials.gov/search?id=%22NCT00147784%22">https://clinicaltrials.gov/search?id=%22NCT00147784%22</a>   |
| CHEMBL1201560 | PEGINTERFERON ALFA-2A | Protein  | Interferon alpha/beta receptor agonist  | Agonist       | MONDO_0002050 | depressive disorder              | 3 Completed              | <a href="https://clinicaltrials.gov/search?id=%22NCT00136318%22">https://clinicaltrials.gov/search?id=%22NCT00136318%22</a>   |
| CHEMBL1201560 | PEGINTERFERON ALFA-2A | Protein  | Interferon alpha/beta receptor agonist  | Agonist       | EFO_0000182   | hepatocellular carcinoma         | 2 Completed              | <a href="https://clinicaltrials.gov/search?id=%22NCT02576964%22">https://clinicaltrials.gov/search?id=%22NCT02576964%22</a>   |
| CHEMBL1201560 | PEGINTERFERON ALFA-2A | Protein  | Interferon alpha/beta receptor agonist  | Agonist       | EFO_0000339   | chronic myelogenous leukemia     | 2 Completed              | <a href="https://clinicaltrials.gov/search?id=%22NCT01294618%22">https://clinicaltrials.gov/search?id=%22NCT01294618%22</a>   |
| CHEMBL1201560 | PEGINTERFERON ALFA-2A | Protein  | Interferon alpha/beta receptor agonist  | Agonist       | EFO_0000544   | infection                        | 2 Completed              | <a href="https://clinicaltrials.gov/search?id=%22NCT00665353%22">https://clinicaltrials.gov/search?id=%22NCT00665353%22</a> , <a href="https://clinicaltrials.gov/sea">https://clinicaltrials.gov/sea</a> |
| CHEMBL1201560 | PEGINTERFERON ALFA-2A | Protein  | Interferon alpha/beta receptor agonist  | Agonist       | EFO_0000565   | leukemia                         | 2 Terminated             | <a href="https://clinicaltrials.gov/search?id=%22NCT01392170%22">https://clinicaltrials.gov/search?id=%22NCT01392170%22</a>   |
| CHEMBL1201560 | PEGINTERFERON ALFA-2A | Protein  | Interferon alpha/beta receptor agonist  | Agonist       | EFO_0001378   | multiple myeloma                 | 2 Completed              | <a href="https://clinicaltrials.gov/search?id=%22NCT00323505%22">https://clinicaltrials.gov/search?id=%22NCT00323505%22</a>   |
| CHEMBL1201560 | PEGINTERFERON ALFA-2A | Protein  | Interferon alpha/beta receptor agonist  | Agonist       | EFO_1000026   | diffuse intrinsic pontine glioma | 2 Completed              | <a href="https://clinicaltrials.gov/search?id=%22NCT00036569%22">https://clinicaltrials.gov/search?id=%22NCT00036569%22</a>   |
| CHEMBL1201560 | PEGINTERFERON ALFA-2A | Protein  | Interferon alpha/beta receptor agonist  | Agonist       | EFO_1000251   | Fallopian Tube Carcinoma         | 2 Terminated             | <a href="https://clinicaltrials.gov/search?id=%22NCT01773889%22">https://clinicaltrials.gov/search?id=%22NCT01773889%22</a>   |
| CHEMBL1201560 | PEGINTERFERON ALFA-2A | Protein  | Interferon alpha/beta receptor agonist  | Agonist       | HP_0001873    | Thrombocytopenia                 | 2 Completed              | <a href="https://clinicaltrials.gov/search?id=%22NCT01355289%22">https://clinicaltrials.gov/search?id=%22NCT01355289%22</a>   |
| CHEMBL1201560 | PEGINTERFERON ALFA-2A | Protein  | Interferon alpha/beta receptor agonist  | Agonist       | MONDO_0002087 | peritoneum cancer                | 2 Terminated             | <a href="https://clinicaltrials.gov/search?id=%22NCT01773889%22">https://clinicaltrials.gov/search?id=%22NCT01773889%22</a>   |
| CHEMBL1201560 | PEGINTERFERON ALFA-2A | Protein  | Interferon alpha/beta receptor agonist  | Agonist       | MONDO_0007254 | breast cancer                    | 2 Terminated             | <a href="https://clinicaltrials.gov/search?id=%22NCT00227656%22">https://clinicaltrials.gov/search?id=%22NCT00227656%22</a>   |
| CHEMBL1201560 | PEGINTERFERON ALFA-2A | Protein  | Interferon alpha/beta receptor agonist  | Agonist       | MONDO_0008170 | ovarian cancer                   | 2 Terminated             | <a href="https://clinicaltrials.gov/search?id=%22NCT01773889%22">https://clinicaltrials.gov/search?id=%22NCT01773889%22</a>   |
| CHEMBL1201560 | PEGINTERFERON ALFA-2A | Protein  | Interferon alpha/beta receptor agonist  | Agonist       | MONDO_0021063 | malignant colon neoplasm         | 2 Not yet recruiting     | <a href="https://clinicaltrials.gov/search?id=%22NCT04798612%22">https://clinicaltrials.gov/search?id=%22NCT04798612%22</a>   |
| CHEMBL1201560 | PEGINTERFERON ALFA-2A | Protein  | Interferon alpha/beta receptor agonist  | Agonist       | MONDO_0024880 | metastatic malignant neoplasm    | 2 Terminated             | <a href="https://clinicaltrials.gov/search?id=%22NCT00227656%22">https://clinicaltrials.gov/search?id=%22NCT00227656%22</a>   |
| CHEMBL1201560 | PEGINTERFERON ALFA-2A | Protein  | Interferon alpha/beta receptor agonist  | Agonist       | EFO_0000095   | chronic lymphocytic leukemia     | 1 Withdrawn              | <a href="https://clinicaltrials.gov/search?id=%22NCT00962715%22">https://clinicaltrials.gov/search?id=%22NCT00962715%22</a>   |
| CHEMBL1201560 | PEGINTERFERON ALFA-2A | Protein  | Interferon alpha/beta receptor agonist  | Agonist       | EFO_0000222   | acute myeloid leukemia           | 1 Completed              | <a href="https://clinicaltrials.gov/search?id=%22NCT02328755%22">https://clinicaltrials.gov/search?id=%22NCT02328755%22</a>   |
| CHEMBL1201560 | PEGINTERFERON ALFA-2A | Protein  | Interferon alpha/beta receptor agonist  | Agonist       | EFO_0000311   | cancer                           | 1 Completed              | <a href="https://clinicaltrials.gov/search?id=%22NCT02174172%22">https://clinicaltrials.gov/search?id=%22NCT02174172%22</a>   |
| CHEMBL1201560 | PEGINTERFERON ALFA-2A | Protein  | Interferon alpha/beta receptor agonist  | Agonist       | EFO_0000479   | essential thrombocythemia        | 1 Completed              | <a href="https://clinicaltrials.gov/search?id=%22NCT02407080%22">https://clinicaltrials.gov/search?id=%22NCT02407080%22</a>   |
| CHEMBL1201560 | PEGINTERFERON ALFA-2A | Protein  | Interferon alpha/beta receptor agonist  | Agonist       | EFO_0000616   | neoplasm                         | 1 Completed              | <a href="https://clinicaltrials.gov/search?id=%22NCT00253474%22">https://clinicaltrials.gov/search?id=%22NCT00253474%22</a>   |

|               |                       |         |  |         |               |                                     |                          |   |
|---------------|-----------------------|---------|--|---------|---------------|-------------------------------------|--------------------------|---|
| CHEMBL1201560 | PEGINTERFERON ALFA-2A | Protein | Interferon alpha/beta receptor agonist | Agonist | EFO_0000764   | HIV infection                       | 1 Recruiting             | <a href="https://clinicaltrials.gov/search?id=%22NCT02471430%22">https://clinicaltrials.gov/search?id=%22NCT02471430%22</a>   |
| CHEMBL1201560 | PEGINTERFERON ALFA-2A | Protein | Interferon alpha/beta receptor agonist | Agonist | EFO_0002429   | polycythemia vera                   | 1 Completed              | <a href="https://clinicaltrials.gov/search?id=%22NCT02407080%22">https://clinicaltrials.gov/search?id=%22NCT02407080%22</a>   |
| CHEMBL1201560 | PEGINTERFERON ALFA-2A | Protein | Interferon alpha/beta receptor agonist | Agonist | EFO_0003047   | hepatitis C virus infection         | 1 Terminated             | <a href="https://clinicaltrials.gov/search?id=%22NCT00277758%22">https://clinicaltrials.gov/search?id=%22NCT00277758%22</a>   |
| CHEMBL1201560 | PEGINTERFERON ALFA-2A | Protein | Interferon alpha/beta receptor agonist | Agonist | EFO_0004197   | hepatitis B virus infection         | 1 Completed              | <a href="https://clinicaltrials.gov/search?id=%22NCT03294798%22">https://clinicaltrials.gov/search?id=%22NCT03294798%22</a>   |
| CHEMBL1201560 | PEGINTERFERON ALFA-2A | Protein | Interferon alpha/beta receptor agonist | Agonist | EFO_0004220   | chronic hepatitis C virus infection | 1 Unknown status         | <a href="https://clinicaltrials.gov/search?id=%22NCT02057887%22">https://clinicaltrials.gov/search?id=%22NCT02057887%22</a> , <a href="https://clinicaltrials.gov/sea">https://clinicaltrials.gov/sea</a> |
| CHEMBL1201560 | PEGINTERFERON ALFA-2A | Protein | Interferon alpha/beta receptor agonist | Agonist | EFO_0004239   | chronic hepatitis B virus infection | 1 Unknown status         | <a href="https://clinicaltrials.gov/search?id=%22NCT01589952%22">https://clinicaltrials.gov/search?id=%22NCT01589952%22</a>   |
| CHEMBL1201560 | PEGINTERFERON ALFA-2A | Protein | Interferon alpha/beta receptor agonist | Agonist | EFO_0007304   | hepatitis D virus infection         | 1 Completed              | <a href="https://clinicaltrials.gov/search?id=%22NCT02637999%22">https://clinicaltrials.gov/search?id=%22NCT02637999%22</a>   |
| CHEMBL1201560 | PEGINTERFERON ALFA-2A | Protein | Interferon alpha/beta receptor agonist | Agonist | EFO_0009260   | non-melanoma skin carcinoma         | 1 Unknown status         | <a href="https://clinicaltrials.gov/search?id=%22NCT00423397%22">https://clinicaltrials.gov/search?id=%22NCT00423397%22</a>   |
| CHEMBL1201560 | PEGINTERFERON ALFA-2A | Protein | Interferon alpha/beta receptor agonist | Agonist | MONDO_0002367 | kidney cancer                       | 1 Completed              | <a href="https://clinicaltrials.gov/search?id=%22NCT00003542%22">https://clinicaltrials.gov/search?id=%22NCT00003542%22</a>   |
| CHEMBL1201560 | PEGINTERFERON ALFA-2A | Protein | Interferon alpha/beta receptor agonist | Agonist | MONDO_0044903 | myelofibrosis                       | 1 Active, not recruiting | <a href="https://clinicaltrials.gov/search?id=%22NCT02742324%22">https://clinicaltrials.gov/search?id=%22NCT02742324%22</a>   |
| CHEMBL1201561 | PEGINTERFERON ALFA-2B | Protein | Interferon alpha/beta receptor agonist | Agonist | EFO_0000479   | essential thrombocythemia           | 3 Unknown status         | <a href="https://clinicaltrials.gov/search?id=%22NCT01387763%22">https://clinicaltrials.gov/search?id=%22NCT01387763%22</a>   |
| CHEMBL1201561 | PEGINTERFERON ALFA-2B | Protein | Interferon alpha/beta receptor agonist | Agonist | EFO_0000637   | osteosarcoma                        | 3 Unknown status         | <a href="https://clinicaltrials.gov/search?id=%22NCT00134030%22">https://clinicaltrials.gov/search?id=%22NCT00134030%22</a>   |
| CHEMBL1201561 | PEGINTERFERON ALFA-2B | Protein | Interferon alpha/beta receptor agonist | Agonist | EFO_0001378   | multiple myeloma                    | 3 Completed              | <a href="https://clinicaltrials.gov/search?id=%22NCT00732641%22">https://clinicaltrials.gov/search?id=%22NCT00732641%22</a>   |
| CHEMBL1201561 | PEGINTERFERON ALFA-2B | Protein | Interferon alpha/beta receptor agonist | Agonist | EFO_0001422   | cirrhosis of liver                  | 3 Completed              | <a href="https://clinicaltrials.gov/search?id=%22NCT00378599%22">https://clinicaltrials.gov/search?id=%22NCT00378599%22</a> , <a href="https://clinicaltrials.gov/sea">https://clinicaltrials.gov/sea</a> |
| CHEMBL1201561 | PEGINTERFERON ALFA-2B | Protein | Interferon alpha/beta receptor agonist | Agonist | EFO_0002430   | primary myelofibrosis               | 3 Unknown status         | <a href="https://clinicaltrials.gov/search?id=%22NCT01387763%22">https://clinicaltrials.gov/search?id=%22NCT01387763%22</a>   |
| CHEMBL1201561 | PEGINTERFERON ALFA-2B | Protein | Interferon alpha/beta receptor agonist | Agonist | EFO_0009708   | metastasis                          | 3 Completed              | <a href="https://clinicaltrials.gov/search?id=%22NCT00221702%22">https://clinicaltrials.gov/search?id=%22NCT00221702%22</a>   |
| CHEMBL1201561 | PEGINTERFERON ALFA-2B | Protein | Interferon alpha/beta receptor agonist | Agonist | EFO_1001469   | Mantle cell lymphoma                | 3 Unknown status         | <a href="https://clinicaltrials.gov/search?id=%22NCT00209209%22">https://clinicaltrials.gov/search?id=%22NCT00209209%22</a>   |
| CHEMBL1201561 | PEGINTERFERON ALFA-2B | Protein | Interferon alpha/beta receptor agonist | Agonist | HP_0012115    | Hepatitis                           | 3 Completed              | <a href="https://clinicaltrials.gov/search?id=%22NCT00039871%22">https://clinicaltrials.gov/search?id=%22NCT00039871%22</a>   |
| CHEMBL1201561 | PEGINTERFERON ALFA-2B | Protein | Interferon alpha/beta receptor agonist | Agonist | EFO_0000326   | central nervous system cancer       | 2 Completed              | <a href="https://clinicaltrials.gov/search?id=%22NCT00047879%22">https://clinicaltrials.gov/search?id=%22NCT00047879%22</a>   |
| CHEMBL1201561 | PEGINTERFERON ALFA-2B | Protein | Interferon alpha/beta receptor agonist | Agonist | EFO_0000389   | cutaneous melanoma                  | 2 Completed              | <a href="https://clinicaltrials.gov/search?id=%22NCT00049530%22">https://clinicaltrials.gov/search?id=%22NCT00049530%22</a> , <a href="https://clinicaltrials.gov/sea">https://clinicaltrials.gov/sea</a> |
| CHEMBL1201561 | PEGINTERFERON ALFA-2B | Protein | Interferon alpha/beta receptor agonist | Agonist | EFO_0000565   | leukemia                            | 2 Completed              | <a href="https://clinicaltrials.gov/search?id=%22NCT00548847%22">https://clinicaltrials.gov/search?id=%22NCT00548847%22</a>   |
| CHEMBL1201561 | PEGINTERFERON ALFA-2B | Protein | Interferon alpha/beta receptor agonist | Agonist | EFO_0000574   | lymphoma                            | 2 Recruiting             | <a href="https://clinicaltrials.gov/search?id=%22NCT04246359%22">https://clinicaltrials.gov/search?id=%22NCT04246359%22</a>   |
| CHEMBL1201561 | PEGINTERFERON ALFA-2B | Protein | Interferon alpha/beta receptor agonist | Agonist | EFO_0000658   | plexiform neurofibroma              | 2 Completed              | <a href="https://clinicaltrials.gov/search?id=%22NCT00396019%22">https://clinicaltrials.gov/search?id=%22NCT00396019%22</a>   |
| CHEMBL1201561 | PEGINTERFERON ALFA-2B | Protein | Interferon alpha/beta receptor agonist | Agonist | EFO_0000707   | squamous cell carcinoma             | 2 Active, not recruiting | <a href="https://clinicaltrials.gov/search?id=%22NCT02218164%22">https://clinicaltrials.gov/search?id=%22NCT02218164%22</a>   |
| CHEMBL1201561 | PEGINTERFERON ALFA-2B | Protein | Interferon alpha/beta receptor agonist | Agonist | EFO_0001642   | lymphoid neoplasm                   | 2 Recruiting             | <a href="https://clinicaltrials.gov/search?id=%22NCT02634294%22">https://clinicaltrials.gov/search?id=%22NCT02634294%22</a>   |
| CHEMBL1201561 | PEGINTERFERON ALFA-2B | Protein | Interferon alpha/beta receptor agonist | Agonist | EFO_0004197   | hepatitis B virus infection         | 2 Active, not recruiting | <a href="https://clinicaltrials.gov/search?id=%22NCT04189276%22">https://clinicaltrials.gov/search?id=%22NCT04189276%22</a>   |
| CHEMBL1201561 | PEGINTERFERON ALFA-2B | Protein | Interferon alpha/beta receptor agonist | Agonist | EFO_0004239   | chronic hepatitis B virus infection | 2 Completed              | <a href="https://clinicaltrials.gov/search?id=%22NCT02332473%22">https://clinicaltrials.gov/search?id=%22NCT02332473%22</a> , <a href="https://clinicaltrials.gov/sea">https://clinicaltrials.gov/sea</a> |
| CHEMBL1201561 | PEGINTERFERON ALFA-2B | Protein | Interferon alpha/beta receptor agonist | Agonist | EFO_0004243   | carcinoid tumor                     | 2 Completed              | <a href="https://clinicaltrials.gov/search?id=%22NCT00055809%22">https://clinicaltrials.gov/search?id=%22NCT00055809%22</a>   |
| CHEMBL1201561 | PEGINTERFERON ALFA-2B | Protein | Interferon alpha/beta receptor agonist | Agonist | EFO_0005221   | cholangiocarcinoma                  | 2 Terminated             | <a href="https://clinicaltrials.gov/search?id=%22NCT02982720%22">https://clinicaltrials.gov/search?id=%22NCT02982720%22</a>   |
| CHEMBL1201561 | PEGINTERFERON ALFA-2B | Protein | Interferon alpha/beta receptor agonist | Agonist | EFO_0006859   | head and neck malignant neoplasia   | 2 Completed              | <a href="https://clinicaltrials.gov/search?id=%22NCT00276523%22">https://clinicaltrials.gov/search?id=%22NCT00276523%22</a>   |
| CHEMBL1201561 | PEGINTERFERON ALFA-2B | Protein | Interferon alpha/beta receptor agonist | Agonist | EFO_0007304   | hepatitis D virus infection         | 2 Unknown status         | <a href="https://clinicaltrials.gov/search?id=%22NCT03105310%22">https://clinicaltrials.gov/search?id=%22NCT03105310%22</a>   |
| CHEMBL1201561 | PEGINTERFERON ALFA-2B | Protein | Interferon alpha/beta receptor agonist | Agonist | EFO_0009259   | skin carcinoma                      | 2 Active, not recruiting | <a href="https://clinicaltrials.gov/search?id=%22NCT02218164%22">https://clinicaltrials.gov/search?id=%22NCT02218164%22</a>   |

|               |                       |             |   |         |               |  |                          |   |
|---------------|-----------------------|-------------|---|---------|---------------|--|--------------------------|---|
| CHEMBL1201561 | PEGINTERFERON ALFA-2B | Protein     | Interferon alpha/beta receptor agonist                                    | Agonist | EFO_1000209   | Craniopharyngioma                      | 2 Terminated             | <a href="https://clinicaltrials.gov/search?id=%22NCT01964300%22">https://clinicaltrials.gov/search?id=%22NCT01964300%22</a>   |
| CHEMBL1201561 | PEGINTERFERON ALFA-2B | Protein     | Interferon alpha/beta receptor agonist                                    | Agonist | EFO_1000403   | Ocular Melanoma                        | 2 Completed              | <a href="https://clinicaltrials.gov/search?id=%22NCT00027742%22">https://clinicaltrials.gov/search?id=%22NCT00027742%22</a> , <a href="https://clinicaltrials.gov/sea">https://clinicaltrials.gov/sea</a> |
| CHEMBL1201561 | PEGINTERFERON ALFA-2B | Protein     | Interferon alpha/beta receptor agonist                                    | Agonist | MONDO_0002974 | cervical cancer                        | 2 Terminated             | <a href="https://clinicaltrials.gov/search?id=%22NCT00138151%22">https://clinicaltrials.gov/search?id=%22NCT00138151%22</a>   |
| CHEMBL1201561 | PEGINTERFERON ALFA-2B | Protein     | Interferon alpha/beta receptor agonist                                    | Agonist | MONDO_0016691 | pilocytic astrocytoma                  | 2 Recruiting             | <a href="https://clinicaltrials.gov/search?id=%22NCT02343224%22">https://clinicaltrials.gov/search?id=%22NCT02343224%22</a>   |
| CHEMBL1201561 | PEGINTERFERON ALFA-2B | Protein     | Interferon alpha/beta receptor agonist                                    | Agonist | MONDO_0018079 | thymic epithelial neoplasm             | 2 Not yet recruiting     | <a href="https://clinicaltrials.gov/search?id=%22NCT04517539%22">https://clinicaltrials.gov/search?id=%22NCT04517539%22</a>   |
| CHEMBL1201561 | PEGINTERFERON ALFA-2B | Protein     | Interferon alpha/beta receptor agonist                                    | Agonist | MONDO_0019471 | adult T-cell leukemia/lymphoma         | 2 Recruiting             | <a href="https://clinicaltrials.gov/search?id=%22NCT02737046%22">https://clinicaltrials.gov/search?id=%22NCT02737046%22</a>   |
| CHEMBL1201561 | PEGINTERFERON ALFA-2B | Protein     | Interferon alpha/beta receptor agonist                                    | Agonist | MONDO_0100096 | COVID-19                               | 2 Active, not recruiting | <a href="https://clinicaltrials.gov/search?id=%22NCT04480138%22">https://clinicaltrials.gov/search?id=%22NCT04480138%22</a>   |
| CHEMBL1201561 | PEGINTERFERON ALFA-2B | Protein     | Interferon alpha/beta receptor agonist                                    | Agonist | Orphanet_636  | Neurofibromatosis type 1               | 2 Unknown status         | <a href="https://clinicaltrials.gov/search?id=%22NCT00846430%22">https://clinicaltrials.gov/search?id=%22NCT00846430%22</a>   |
| CHEMBL1201561 | PEGINTERFERON ALFA-2B | Protein     | Interferon alpha/beta receptor agonist                                    | Agonist | EFO_0000180   | HIV-1 infection                        | 1 Active, not recruiting | <a href="https://clinicaltrials.gov/search?id=%22NCT03588715%22">https://clinicaltrials.gov/search?id=%22NCT03588715%22</a>   |
| CHEMBL1201561 | PEGINTERFERON ALFA-2B | Protein     | Interferon alpha/beta receptor agonist                                    | Agonist | EFO_0000182   | hepatocellular carcinoma               | 1 Recruiting             | <a href="https://clinicaltrials.gov/search?id=%22NCT04943679%22">https://clinicaltrials.gov/search?id=%22NCT04943679%22</a>   |
| CHEMBL1201561 | PEGINTERFERON ALFA-2B | Protein     | Interferon alpha/beta receptor agonist                                    | Agonist | EFO_0000311   | cancer                                 | 1 Terminated             | <a href="https://clinicaltrials.gov/search?id=%22NCT00311558%22">https://clinicaltrials.gov/search?id=%22NCT00311558%22</a> , <a href="https://clinicaltrials.gov/sea">https://clinicaltrials.gov/sea</a> |
| CHEMBL1201561 | PEGINTERFERON ALFA-2B | Protein     | Interferon alpha/beta receptor agonist                                    | Agonist | EFO_0000339   | chronic myelogenous leukemia           | 1 Completed              | <a href="https://clinicaltrials.gov/search?id=%22NCT00303290%22">https://clinicaltrials.gov/search?id=%22NCT00303290%22</a>   |
| CHEMBL1201561 | PEGINTERFERON ALFA-2B | Protein     | Interferon alpha/beta receptor agonist                                    | Agonist | EFO_0000616   | neoplasm                               | 1 Completed              | <a href="https://clinicaltrials.gov/search?id=%22NCT00014261%22">https://clinicaltrials.gov/search?id=%22NCT00014261%22</a> , <a href="https://clinicaltrials.gov/sea">https://clinicaltrials.gov/sea</a> |
| CHEMBL1201561 | PEGINTERFERON ALFA-2B | Protein     | Interferon alpha/beta receptor agonist                                    | Agonist | EFO_0000681   | renal cell carcinoma                   | 1 Terminated             | <a href="https://clinicaltrials.gov/search?id=%22NCT00522249%22">https://clinicaltrials.gov/search?id=%22NCT00522249%22</a>   |
| CHEMBL1201561 | PEGINTERFERON ALFA-2B | Protein     | Interferon alpha/beta receptor agonist                                    | Agonist | EFO_0000756   | melanoma                               | 1 Completed              | <a href="https://clinicaltrials.gov/search?id=%22NCT01496807%22">https://clinicaltrials.gov/search?id=%22NCT01496807%22</a> , <a href="https://clinicaltrials.gov/sea">https://clinicaltrials.gov/sea</a> |
| CHEMBL1201561 | PEGINTERFERON ALFA-2B | Protein     | Interferon alpha/beta receptor agonist                                    | Agonist | EFO_0000764   | HIV infection                          | 1 Completed              | <a href="https://clinicaltrials.gov/search?id=%22NCT00006325%22">https://clinicaltrials.gov/search?id=%22NCT00006325%22</a>   |
| CHEMBL1201561 | PEGINTERFERON ALFA-2B | Protein     | Interferon alpha/beta receptor agonist                                    | Agonist | EFO_0000765   | AIDS                                   | 1 Active, not recruiting | <a href="https://clinicaltrials.gov/search?id=%22NCT03588715%22">https://clinicaltrials.gov/search?id=%22NCT03588715%22</a>   |
| CHEMBL1201561 | PEGINTERFERON ALFA-2B | Protein     | Interferon alpha/beta receptor agonist                                    | Agonist | EFO_0002429   | polycythemia vera                      | 1 Completed              | <a href="https://clinicaltrials.gov/search?id=%22NCT01193699%22">https://clinicaltrials.gov/search?id=%22NCT01193699%22</a>   |
| CHEMBL1201561 | PEGINTERFERON ALFA-2B | Protein     | Interferon alpha/beta receptor agonist                                    | Agonist | EFO_0002617   | metastatic melanoma                    | 1 Completed              | <a href="https://clinicaltrials.gov/search?id=%22NCT02379195%22">https://clinicaltrials.gov/search?id=%22NCT02379195%22</a>   |
| CHEMBL1201561 | PEGINTERFERON ALFA-2B | Protein     | Interferon alpha/beta receptor agonist                                    | Agonist | EFO_0003047   | hepatitis C virus infection            | 1 Terminated             | <a href="https://clinicaltrials.gov/search?id=%22NCT01701063%22">https://clinicaltrials.gov/search?id=%22NCT01701063%22</a>   |
| CHEMBL1201561 | PEGINTERFERON ALFA-2B | Protein     | Interferon alpha/beta receptor agonist                                    | Agonist | EFO_0004220   | chronic hepatitis C virus infection    | 1 Completed              | <a href="https://clinicaltrials.gov/search?id=%22NCT00120835%22">https://clinicaltrials.gov/search?id=%22NCT00120835%22</a> , <a href="https://clinicaltrials.gov/sea">https://clinicaltrials.gov/sea</a> |
| CHEMBL1201561 | PEGINTERFERON ALFA-2B | Protein     | Interferon alpha/beta receptor agonist                                    | Agonist | HP_0000083    | Renal insufficiency                    | 1 Completed              | <a href="https://clinicaltrials.gov/search?id=%22NCT01432535%22">https://clinicaltrials.gov/search?id=%22NCT01432535%22</a>   |
| CHEMBL1201561 | PEGINTERFERON ALFA-2B | Protein     | Interferon alpha/beta receptor agonist                                    | Agonist | MONDO_0002087 | peritoneum cancer                      | 1 Terminated             | <a href="https://clinicaltrials.gov/search?id=%22NCT00085384%22">https://clinicaltrials.gov/search?id=%22NCT00085384%22</a>   |
| CHEMBL1201561 | PEGINTERFERON ALFA-2B | Protein     | Interferon alpha/beta receptor agonist                                    | Agonist | MONDO_0002158 | fallopian tube cancer                  | 1 Terminated             | <a href="https://clinicaltrials.gov/search?id=%22NCT00085384%22">https://clinicaltrials.gov/search?id=%22NCT00085384%22</a>   |
| CHEMBL1201561 | PEGINTERFERON ALFA-2B | Protein     | Interferon alpha/beta receptor agonist                                    | Agonist | MONDO_0002367 | kidney cancer                          | 1 Terminated             | <a href="https://clinicaltrials.gov/search?id=%22NCT00589550%22">https://clinicaltrials.gov/search?id=%22NCT00589550%22</a>   |
| CHEMBL1201561 | PEGINTERFERON ALFA-2B | Protein     | Interferon alpha/beta receptor agonist                                    | Agonist | MONDO_0008170 | ovarian cancer                         | 1 Terminated             | <a href="https://clinicaltrials.gov/search?id=%22NCT00085384%22">https://clinicaltrials.gov/search?id=%22NCT00085384%22</a>   |
| CHEMBL2108677 | PEGINTERFERON BETA-1A | Protein     | Interferon alpha/beta receptor agonist                                    | Agonist | EFO_0000694   | severe acute respiratory syndrome      | 3 Recruiting             | <a href="https://clinicaltrials.gov/search?id=%22NCT04727424%22">https://clinicaltrials.gov/search?id=%22NCT04727424%22</a>   |
| CHEMBL2108677 | PEGINTERFERON BETA-1A | Protein     | Interferon alpha/beta receptor agonist                                    | Agonist | EFO_0003929   | relapsing-remitting multiple sclerosis | 3 Withdrawn              | <a href="https://clinicaltrials.gov/search?id=%22NCT01337427%22">https://clinicaltrials.gov/search?id=%22NCT01337427%22</a>   |
| CHEMBL2108677 | PEGINTERFERON BETA-1A | Protein     | Interferon alpha/beta receptor agonist                                    | Agonist | MONDO_0100096 | COVID-19                               | 3 Recruiting             | <a href="https://clinicaltrials.gov/search?id=%22NCT04727424%22">https://clinicaltrials.gov/search?id=%22NCT04727424%22</a>   |
| CHEMBL2108677 | PEGINTERFERON BETA-1A | Protein     | Interferon alpha/beta receptor agonist                                    | Agonist | EFO_0003885   | multiple sclerosis                     | 1 Completed              | <a href="https://clinicaltrials.gov/search?id=%22NCT02269930%22">https://clinicaltrials.gov/search?id=%22NCT02269930%22</a>   |
| CHEMBL2108677 | PEGINTERFERON BETA-1A | Protein     | Interferon alpha/beta receptor agonist                                    | Agonist | HP_0000083    | Renal insufficiency                    | 1 Completed              | <a href="https://clinicaltrials.gov/search?id=%22NCT01119781%22">https://clinicaltrials.gov/search?id=%22NCT01119781%22</a>   |
| CHEMBL2108712 | PLOVAMER ACETATE      | Small molec | HLA class II histocompatibility antigen, DRB1-15 beta chain mox Modulator | Agonist | EFO_0003929   | relapsing-remitting multiple sclerosis | 2 Terminated             | <a href="https://clinicaltrials.gov/search?id=%22NCT01963611%22">https://clinicaltrials.gov/search?id=%22NCT01963611%22</a>   |



|               |            |          |   |               |                 |   |                      |   |
|---------------|------------|----------|---|---------------|-----------------|---|----------------------|---|
| CHEMBL1201830 | RILONACEPT | Protein  | Interleukin-1 beta inhibitor            | Inhibitor     | EFO_0000540     | immune system disease                   | 4                    | <a href="http://www.whocc.no/atc_ddd_index/?code=L04AC04">http://www.whocc.no/atc_ddd_index/?code=L04AC04</a>   |
| CHEMBL1201830 | RILONACEPT | Protein  | Interleukin-1 beta inhibitor            | Inhibitor     | EFO_0003884     | chronic kidney disease                  | 4 Completed          | <a href="https://clinicaltrials.gov/search?id=%22NCT01663103%22">https://clinicaltrials.gov/search?id=%22NCT01663103%22</a>   |
| CHEMBL1201830 | RILONACEPT | Protein  | Interleukin-1 beta inhibitor            | Inhibitor     | Orphanet_208650 | Cryopyrin-associated periodic syndrom   | 4                    | <a href="http://dailymed.nlm.nih.gov/dailymed/drugInfo.cfm?setid=282f4099-e848-432a-bac1-">http://dailymed.nlm.nih.gov/dailymed/drugInfo.cfm?setid=282f4099-e848-432a-bac1-</a>                           |
| CHEMBL1201830 | RILONACEPT | Protein  | Interleukin-1 beta inhibitor            | Inhibitor     | Orphanet_47045  | Familial cold urticaria                 | 3 Completed          | <a href="https://clinicaltrials.gov/search?id=%22NCT00288704%22">https://clinicaltrials.gov/search?id=%22NCT00288704%22</a>   |
| CHEMBL1201830 | RILONACEPT | Protein  | Interleukin-1 beta inhibitor            | Inhibitor     | Orphanet_575    | Muckle-Wells syndrome                   | 3 Completed          | <a href="https://clinicaltrials.gov/search?id=%22NCT00288704%22">https://clinicaltrials.gov/search?id=%22NCT00288704%22</a>   |
| CHEMBL1201830 | RILONACEPT | Protein  | Interleukin-1 beta inhibitor            | Inhibitor     | EFO_0002609     | juvenile idiopathic arthritis           | 2 Completed          | <a href="https://clinicaltrials.gov/search?id=%22NCT00534495%22">https://clinicaltrials.gov/search?id=%22NCT00534495%22</a>   |
| CHEMBL1201830 | RILONACEPT | Protein  | Interleukin-1 beta inhibitor            | Inhibitor     | EFO_0004274     | gout                                    | 2 Completed          | <a href="https://clinicaltrials.gov/search?id=%22NCT00610363%22">https://clinicaltrials.gov/search?id=%22NCT00610363%22</a>   |
| CHEMBL1201830 | RILONACEPT | Protein  | Interleukin-1 beta inhibitor            | Inhibitor     | EFO_0007427     | pericarditis                            | 2 Completed          | <a href="https://clinicaltrials.gov/search?id=%22NCT03980522%22">https://clinicaltrials.gov/search?id=%22NCT03980522%22</a>   |
| CHEMBL1201830 | RILONACEPT | Protein  | Interleukin-1 beta inhibitor            | Inhibitor     | EFO_1001345     | Hepatitis, Alcoholic                    | 2 Completed          | <a href="https://clinicaltrials.gov/search?id=%22NCT01903798%22">https://clinicaltrials.gov/search?id=%22NCT01903798%22</a>   |
| CHEMBL1201830 | RILONACEPT | Protein  | Interleukin-1 beta inhibitor            | Inhibitor     | EFO_1001881     | cold urticaria                          | 2 Completed          | <a href="https://clinicaltrials.gov/search?id=%22NCT02171416%22">https://clinicaltrials.gov/search?id=%22NCT02171416%22</a>   |
| CHEMBL1201830 | RILONACEPT | Protein  | Interleukin-1 beta inhibitor            | Inhibitor     | Orphanet_210115 | Sterile multifocal osteomyelitis with p | 2 Completed          | <a href="https://clinicaltrials.gov/search?id=%22NCT01801449%22">https://clinicaltrials.gov/search?id=%22NCT01801449%22</a>   |
| CHEMBL1201830 | RILONACEPT | Protein  | Interleukin-1 beta inhibitor            | Inhibitor     | Orphanet_342    | Familial Mediterranean fever            | 2 Completed          | <a href="https://clinicaltrials.gov/search?id=%22NCT00582907%22">https://clinicaltrials.gov/search?id=%22NCT00582907%22</a>   |
| CHEMBL1201830 | RILONACEPT | Protein  | Interleukin-1 beta inhibitor            | Inhibitor     | EFO_0000404     | diffuse scleroderma                     | 1 Completed          | <a href="https://clinicaltrials.gov/search?id=%22NCT01538719%22">https://clinicaltrials.gov/search?id=%22NCT01538719%22</a>   |
| CHEMBL1201830 | RILONACEPT | Protein  | Interleukin-1 beta inhibitor            | Inhibitor     | EFO_0001359     | type I diabetes mellitus                | 1 Completed          | <a href="https://clinicaltrials.gov/search?id=%22NCT00962026%22">https://clinicaltrials.gov/search?id=%22NCT00962026%22</a>   |
| CHEMBL1201830 | RILONACEPT | Protein  | Interleukin-1 beta inhibitor            | Inhibitor     | EFO_1001999     | systemic juvenile idiopathic arthritis  | 1 Completed          | <a href="https://clinicaltrials.gov/search?id=%22NCT01803321%22">https://clinicaltrials.gov/search?id=%22NCT01803321%22</a>   |
| CHEMBL1201830 | RILONACEPT | Protein  | Interleukin-1 beta inhibitor            | Inhibitor     | EFO_0004238     | hearing loss                            | 0 Unknown status     | <a href="https://clinicaltrials.gov/search?id=%22NCT02828033%22">https://clinicaltrials.gov/search?id=%22NCT02828033%22</a>   |
| CHEMBL1201576 | RITUXIMAB  | Antibody | B-lymphocyte antigen CD20 binding agent | Binding agent | EFO_0000474     | epilepsy                                | 4 Not yet recruiting | <a href="https://clinicaltrials.gov/search?id=%22NCT04542629%22">https://clinicaltrials.gov/search?id=%22NCT04542629%22</a>   |
| CHEMBL1201576 | RITUXIMAB  | Antibody | B-lymphocyte antigen CD20 binding agent | Binding agent | EFO_0004194     | IGA glomerulonephritis                  | 4 Recruiting         | <a href="https://clinicaltrials.gov/search?id=%22NCT04525729%22">https://clinicaltrials.gov/search?id=%22NCT04525729%22</a>   |
| CHEMBL1201576 | RITUXIMAB  | Antibody | B-lymphocyte antigen CD20 binding agent | Binding agent | HP_0000083      | Renal insufficiency                     | 4 Terminated         | <a href="https://clinicaltrials.gov/search?id=%22NCT01312064%22">https://clinicaltrials.gov/search?id=%22NCT01312064%22</a>   |
| CHEMBL1201576 | RITUXIMAB  | Antibody | B-lymphocyte antigen CD20 binding agent | Binding agent | EFO_0003929     | relapsing-remitting multiple sclerosis  | 3 Recruiting         | <a href="https://clinicaltrials.gov/search?id=%22NCT04578639%22">https://clinicaltrials.gov/search?id=%22NCT04578639%22</a>   |
| CHEMBL1201576 | RITUXIMAB  | Antibody | B-lymphocyte antigen CD20 binding agent | Binding agent | EFO_0004719     | pemphigus vulgaris                      | 3 Completed          | <a href="https://clinicaltrials.gov/search?id=%22NCT02383589%22">https://clinicaltrials.gov/search?id=%22NCT02383589%22</a> , <a href="https://clinicaltrials.gov/sea">https://clinicaltrials.gov/sea</a> |
| CHEMBL1201576 | RITUXIMAB  | Antibody | B-lymphocyte antigen CD20 binding agent | Binding agent | EFO_0004826     | anti-neutrophil antibody associated va  | 3 Completed          | <a href="https://clinicaltrials.gov/search?id=%22NCT01697267%22">https://clinicaltrials.gov/search?id=%22NCT01697267%22</a> , <a href="https://clinicaltrials.gov/sea">https://clinicaltrials.gov/sea</a> |
| CHEMBL1201576 | RITUXIMAB  | Antibody | B-lymphocyte antigen CD20 binding agent | Binding agent | EFO_0009562     | polyneuropathy                          | 3 Completed          | <a href="https://clinicaltrials.gov/search?id=%22NCT00259974%22">https://clinicaltrials.gov/search?id=%22NCT00259974%22</a>   |
| CHEMBL1201576 | RITUXIMAB  | Antibody | B-lymphocyte antigen CD20 binding agent | Binding agent | HP_0000093      | Proteinuria                             | 3 Terminated         | <a href="https://clinicaltrials.gov/search?id=%22NCT01164098%22">https://clinicaltrials.gov/search?id=%22NCT01164098%22</a>   |
| CHEMBL1201576 | RITUXIMAB  | Antibody | B-lymphocyte antigen CD20 binding agent | Binding agent | MONDO_0000432   | lymphoplasmacytic lymphoma              | 3 Completed          | <a href="https://clinicaltrials.gov/search?id=%22NCT00801281%22">https://clinicaltrials.gov/search?id=%22NCT00801281%22</a>   |
| CHEMBL1201576 | RITUXIMAB  | Antibody | B-lymphocyte antigen CD20 binding agent | Binding agent | EFO_0000255     | angioimmunoblastic T-cell lymphoma      | 2 Completed          | <a href="https://clinicaltrials.gov/search?id=%22NCT00169156%22">https://clinicaltrials.gov/search?id=%22NCT00169156%22</a>   |
| CHEMBL1201576 | RITUXIMAB  | Antibody | B-lymphocyte antigen CD20 binding agent | Binding agent | EFO_0000389     | cutaneous melanoma                      | 2 Unknown status     | <a href="https://clinicaltrials.gov/search?id=%22NCT02142335%22">https://clinicaltrials.gov/search?id=%22NCT02142335%22</a>   |
| CHEMBL1201576 | RITUXIMAB  | Antibody | B-lymphocyte antigen CD20 binding agent | Binding agent | EFO_0000540     | immune system disease                   | 2 Recruiting         | <a href="https://clinicaltrials.gov/search?id=%22NCT03651518%22">https://clinicaltrials.gov/search?id=%22NCT03651518%22</a>   |
| CHEMBL1201576 | RITUXIMAB  | Antibody | B-lymphocyte antigen CD20 binding agent | Binding agent | EFO_0000557     | juvenile dermatomyositis                | 2 Completed          | <a href="https://clinicaltrials.gov/search?id=%22NCT00106184%22">https://clinicaltrials.gov/search?id=%22NCT00106184%22</a>   |
| CHEMBL1201576 | RITUXIMAB  | Antibody | B-lymphocyte antigen CD20 binding agent | Binding agent | EFO_0000717     | systemic scleroderma                    | 2 Unknown status     | <a href="https://clinicaltrials.gov/search?id=%22NCT00379431%22">https://clinicaltrials.gov/search?id=%22NCT00379431%22</a>   |
| CHEMBL1201576 | RITUXIMAB  | Antibody | B-lymphocyte antigen CD20 binding agent | Binding agent | EFO_0000729     | ulcerative colitis                      | 2 Completed          | <a href="https://clinicaltrials.gov/search?id=%22NCT00261118%22">https://clinicaltrials.gov/search?id=%22NCT00261118%22</a>   |
| CHEMBL1201576 | RITUXIMAB  | Antibody | B-lymphocyte antigen CD20 binding agent | Binding agent | EFO_0000765     | AIDS                                    | 2 Recruiting         | <a href="https://clinicaltrials.gov/search?id=%22NCT02199184%22">https://clinicaltrials.gov/search?id=%22NCT02199184%22</a>   |

|               |           |          |   |               |             |   |                          |   |
|---------------|-----------|----------|---|---------------|-------------|---|--------------------------|---|
| CHEMBL1201576 | RITUXIMAB | Antibody | B-lymphocyte antigen CD20 binding agent | Binding agent | EFO_0000772 | pneumococcal infection                  | 2 Active, not recruiting | <a href="https://clinicaltrials.gov/search?id=%22NCT03069703%22">https://clinicaltrials.gov/search?id=%22NCT03069703%22</a>   |
| CHEMBL1201576 | RITUXIMAB | Antibody | B-lymphocyte antigen CD20 binding agent | Binding agent | EFO_0002612 | human herpesvirus 8 infection           | 2 Recruiting             | <a href="https://clinicaltrials.gov/search?id=%22NCT01419561%22">https://clinicaltrials.gov/search?id=%22NCT01419561%22</a>   |
| CHEMBL1201576 | RITUXIMAB | Antibody | B-lymphocyte antigen CD20 binding agent | Binding agent | EFO_0002689 | antiphospholipid syndrome               | 2 Completed              | <a href="https://clinicaltrials.gov/search?id=%22NCT00537290%22">https://clinicaltrials.gov/search?id=%22NCT00537290%22</a>   |
| CHEMBL1201576 | RITUXIMAB | Antibody | B-lymphocyte antigen CD20 binding agent | Binding agent | EFO_0003032 | anaplastic large cell lymphoma          | 2 Completed              | <a href="https://clinicaltrials.gov/search?id=%22NCT01686165%22">https://clinicaltrials.gov/search?id=%22NCT01686165%22</a> , <a href="https://clinicaltrials.gov/sea">https://clinicaltrials.gov/sea</a> |
| CHEMBL1201576 | RITUXIMAB | Antibody | B-lymphocyte antigen CD20 binding agent | Binding agent | EFO_0003100 | peripheral neuropathy                   | 2 Unknown status         | <a href="https://clinicaltrials.gov/search?id=%22NCT00006072%22">https://clinicaltrials.gov/search?id=%22NCT00006072%22</a>   |
| CHEMBL1201576 | RITUXIMAB | Antibody | B-lymphocyte antigen CD20 binding agent | Binding agent | EFO_0003144 | heart failure                           | 2 Not yet recruiting     | <a href="https://clinicaltrials.gov/search?id=%22NCT03332888%22">https://clinicaltrials.gov/search?id=%22NCT03332888%22</a>   |
| CHEMBL1201576 | RITUXIMAB | Antibody | B-lymphocyte antigen CD20 binding agent | Binding agent | EFO_0003780 | Behcet's syndrome                       | 2 Completed              | <a href="https://clinicaltrials.gov/search?id=%22NCT00664599%22">https://clinicaltrials.gov/search?id=%22NCT00664599%22</a>   |
| CHEMBL1201576 | RITUXIMAB | Antibody | B-lymphocyte antigen CD20 binding agent | Binding agent | EFO_0003840 | chronic progressive multiple sclerosis  | 2 Completed              | <a href="https://clinicaltrials.gov/search?id=%22NCT02545959%22">https://clinicaltrials.gov/search?id=%22NCT02545959%22</a>   |
| CHEMBL1201576 | RITUXIMAB | Antibody | B-lymphocyte antigen CD20 binding agent | Binding agent | EFO_0003860 | pancreatic neoplasm                     | 2 Completed              | <a href="https://clinicaltrials.gov/search?id=%22NCT00001805%22">https://clinicaltrials.gov/search?id=%22NCT00001805%22</a>   |
| CHEMBL1201576 | RITUXIMAB | Antibody | B-lymphocyte antigen CD20 binding agent | Binding agent | EFO_0003869 | breast neoplasm                         | 2 Completed              | <a href="https://clinicaltrials.gov/search?id=%22NCT00001805%22">https://clinicaltrials.gov/search?id=%22NCT00001805%22</a>   |
| CHEMBL1201576 | RITUXIMAB | Antibody | B-lymphocyte antigen CD20 binding agent | Binding agent | EFO_0003897 | stomach neoplasm                        | 2 Completed              | <a href="https://clinicaltrials.gov/search?id=%22NCT00001805%22">https://clinicaltrials.gov/search?id=%22NCT00001805%22</a>   |
| CHEMBL1201576 | RITUXIMAB | Antibody | B-lymphocyte antigen CD20 binding agent | Binding agent | EFO_0003898 | ankylosing spondylitis                  | 2 Unknown status         | <a href="https://clinicaltrials.gov/search?id=%22NCT00432653%22">https://clinicaltrials.gov/search?id=%22NCT00432653%22</a>   |
| CHEMBL1201576 | RITUXIMAB | Antibody | B-lymphocyte antigen CD20 binding agent | Binding agent | EFO_0004244 | interstitial lung disease               | 2 Withdrawn              | <a href="https://clinicaltrials.gov/search?id=%22NCT02789397%22">https://clinicaltrials.gov/search?id=%22NCT02789397%22</a>   |
| CHEMBL1201576 | RITUXIMAB | Antibody | B-lymphocyte antigen CD20 binding agent | Binding agent | EFO_0004254 | membranous glomerulonephritis           | 2 Completed              | <a href="https://clinicaltrials.gov/search?id=%22NCT01180036%22">https://clinicaltrials.gov/search?id=%22NCT01180036%22</a>   |
| CHEMBL1201576 | RITUXIMAB | Antibody | B-lymphocyte antigen CD20 binding agent | Binding agent | EFO_0004255 | nephrotic syndrome                      | 2 Recruiting             | <a href="https://clinicaltrials.gov/search?id=%22NCT04783675%22">https://clinicaltrials.gov/search?id=%22NCT04783675%22</a> , <a href="https://clinicaltrials.gov/sea">https://clinicaltrials.gov/sea</a> |
| CHEMBL1201576 | RITUXIMAB | Antibody | B-lymphocyte antigen CD20 binding agent | Binding agent | EFO_0004288 | colonic neoplasm                        | 2 Completed              | <a href="https://clinicaltrials.gov/search?id=%22NCT00001805%22">https://clinicaltrials.gov/search?id=%22NCT00001805%22</a>   |
| CHEMBL1201576 | RITUXIMAB | Antibody | B-lymphocyte antigen CD20 binding agent | Binding agent | EFO_0004540 | chronic fatigue syndrome                | 2 Completed              | <a href="https://clinicaltrials.gov/search?id=%22NCT00848692%22">https://clinicaltrials.gov/search?id=%22NCT00848692%22</a>   |
| CHEMBL1201576 | RITUXIMAB | Antibody | B-lymphocyte antigen CD20 binding agent | Binding agent | EFO_0004599 | acute graft vs. host disease            | 2 Completed              | <a href="https://clinicaltrials.gov/search?id=%22NCT00771875%22">https://clinicaltrials.gov/search?id=%22NCT00771875%22</a>   |
| CHEMBL1201576 | RITUXIMAB | Antibody | B-lymphocyte antigen CD20 binding agent | Binding agent | EFO_0005761 | lupus nephritis                         | 2 Completed              | <a href="https://clinicaltrials.gov/search?id=%22NCT02260934%22">https://clinicaltrials.gov/search?id=%22NCT02260934%22</a>   |
| CHEMBL1201576 | RITUXIMAB | Antibody | B-lymphocyte antigen CD20 binding agent | Binding agent | EFO_0007208 | Churg-Strauss syndrome                  | 2 Terminated             | <a href="https://clinicaltrials.gov/search?id=%22NCT00424749%22">https://clinicaltrials.gov/search?id=%22NCT00424749%22</a>   |
| CHEMBL1201576 | RITUXIMAB | Antibody | B-lymphocyte antigen CD20 binding agent | Binding agent | EFO_0007332 | Japanese encephalitis                   | 2 Not yet recruiting     | <a href="https://clinicaltrials.gov/search?id=%22NCT03274375%22">https://clinicaltrials.gov/search?id=%22NCT03274375%22</a>   |
| CHEMBL1201576 | RITUXIMAB | Antibody | B-lymphocyte antigen CD20 binding agent | Binding agent | EFO_0007359 | mast-cell leukemia                      | 2 Completed              | <a href="https://clinicaltrials.gov/search?id=%22NCT00186628%22">https://clinicaltrials.gov/search?id=%22NCT00186628%22</a>   |
| CHEMBL1201576 | RITUXIMAB | Antibody | B-lymphocyte antigen CD20 binding agent | Binding agent | EFO_0009538 | chronic inflammatory demyelinating p    | 2 Not yet recruiting     | <a href="https://clinicaltrials.gov/search?id=%22NCT04480450%22">https://clinicaltrials.gov/search?id=%22NCT04480450%22</a>   |
| CHEMBL1201576 | RITUXIMAB | Antibody | B-lymphocyte antigen CD20 binding agent | Binding agent | EFO_0010580 | blastic plasmacytoid dendritic cell neo | 2 Recruiting             | <a href="https://clinicaltrials.gov/search?id=%22NCT04216524%22">https://clinicaltrials.gov/search?id=%22NCT04216524%22</a>   |
| CHEMBL1201576 | RITUXIMAB | Antibody | B-lymphocyte antigen CD20 binding agent | Binding agent | EFO_1000318 | Langerhans Cell Histiocytosis           | 2 Recruiting             | <a href="https://clinicaltrials.gov/search?id=%22NCT03096782%22">https://clinicaltrials.gov/search?id=%22NCT03096782%22</a>   |
| CHEMBL1201576 | RITUXIMAB | Antibody | B-lymphocyte antigen CD20 binding agent | Binding agent | EFO_1000749 | pemphigus                               | 2 Recruiting             | <a href="https://clinicaltrials.gov/search?id=%22NCT04400994%22">https://clinicaltrials.gov/search?id=%22NCT04400994%22</a>   |
| CHEMBL1201576 | RITUXIMAB | Antibody | B-lymphocyte antigen CD20 binding agent | Binding agent | EFO_1000783 | diabetic neuropathy                     | 2 Completed              | <a href="https://clinicaltrials.gov/search?id=%22NCT00050245%22">https://clinicaltrials.gov/search?id=%22NCT00050245%22</a>   |
| CHEMBL1201576 | RITUXIMAB | Antibody | B-lymphocyte antigen CD20 binding agent | Binding agent | EFO_1000784 | microscopic polyangiitis                | 2 Completed              | <a href="https://clinicaltrials.gov/search?id=%22NCT00104299%22">https://clinicaltrials.gov/search?id=%22NCT00104299%22</a>   |
| CHEMBL1201576 | RITUXIMAB | Antibody | B-lymphocyte antigen CD20 binding agent | Binding agent | EFO_1000868 | chronic inflammatory demyelinating p    | 2 Active, not recruiting | <a href="https://clinicaltrials.gov/search?id=%22NCT03864185%22">https://clinicaltrials.gov/search?id=%22NCT03864185%22</a>   |
| CHEMBL1201576 | RITUXIMAB | Antibody | B-lymphocyte antigen CD20 binding agent | Binding agent | EFO_1001050 | multiple system atrophy                 | 2 Recruiting             | <a href="https://clinicaltrials.gov/search?id=%22NCT04004819%22">https://clinicaltrials.gov/search?id=%22NCT04004819%22</a>   |
| CHEMBL1201576 | RITUXIMAB | Antibody | B-lymphocyte antigen CD20 binding agent | Binding agent | EFO_1001264 | Anemia, Hemolytic, Autoimmune           | 2 Completed              | <a href="https://clinicaltrials.gov/search?id=%22NCT00749112%22">https://clinicaltrials.gov/search?id=%22NCT00749112%22</a> , <a href="https://clinicaltrials.gov/sea">https://clinicaltrials.gov/sea</a> |
| CHEMBL1201576 | RITUXIMAB | Antibody | B-lymphocyte antigen CD20 binding agent | Binding agent | EFO_1001946 | childhood B acute lymphoblastic leuke   | 2 Terminated             | <a href="https://clinicaltrials.gov/search?id=%22NCT00058461%22">https://clinicaltrials.gov/search?id=%22NCT00058461%22</a>   |

|               |           |          |   |               |                 |                                      |   |                        |   |
|---------------|-----------|----------|---|---------------|-----------------|--------------------------------------|---|------------------------|---|
| CHEMBL1201576 | RITUXIMAB | Antibody | B-lymphocyte antigen CD20 binding agent | Binding agent | HP_0012664      | Reduced ejection fraction            | 2 | Not yet recruiting     | <a href="https://clinicaltrials.gov/search?id=%22NCT03332888%22">https://clinicaltrials.gov/search?id=%22NCT03332888%22</a>   |
| CHEMBL1201576 | RITUXIMAB | Antibody | B-lymphocyte antigen CD20 binding agent | Binding agent | MONDO_0000870   | childhood acute lymphoblastic leuker | 2 | Completed              | <a href="https://clinicaltrials.gov/search?id=%22NCT00057811%22">https://clinicaltrials.gov/search?id=%22NCT00057811%22</a>   |
| CHEMBL1201576 | RITUXIMAB | Antibody | B-lymphocyte antigen CD20 binding agent | Binding agent | MONDO_0001549   | hemolytic-uremic syndrome            | 2 | Unknown status         | <a href="https://clinicaltrials.gov/search?id=%22NCT00531089%22">https://clinicaltrials.gov/search?id=%22NCT00531089%22</a>   |
| CHEMBL1201576 | RITUXIMAB | Antibody | B-lymphocyte antigen CD20 binding agent | Binding agent | MONDO_0003541   | adult acute lymphoblastic leukemia   | 2 | Withdrawn              | <a href="https://clinicaltrials.gov/search?id=%22NCT02538926%22">https://clinicaltrials.gov/search?id=%22NCT02538926%22</a>   |
| CHEMBL1201576 | RITUXIMAB | Antibody | B-lymphocyte antigen CD20 binding agent | Binding agent | MONDO_0004695   | liver lymphoma                       | 2 | Recruiting             | <a href="https://clinicaltrials.gov/search?id=%22NCT04115631%22">https://clinicaltrials.gov/search?id=%22NCT04115631%22</a>   |
| CHEMBL1201576 | RITUXIMAB | Antibody | B-lymphocyte antigen CD20 binding agent | Binding agent | MONDO_0009348   | classic Hodgkin lymphoma             | 2 | Completed              | <a href="https://clinicaltrials.gov/search?id=%22NCT00654732%22">https://clinicaltrials.gov/search?id=%22NCT00654732%22</a>   |
| CHEMBL1201576 | RITUXIMAB | Antibody | B-lymphocyte antigen CD20 binding agent | Binding agent | MONDO_0018170   | idiopathic nephrotic syndrome        | 2 | Completed              | <a href="https://clinicaltrials.gov/search?id=%22NCT01268033%22">https://clinicaltrials.gov/search?id=%22NCT01268033%22</a>   |
| CHEMBL1201576 | RITUXIMAB | Antibody | B-lymphocyte antigen CD20 binding agent | Binding agent | MONDO_0019139   | acquired hemophilia                  | 2 | Unknown status         | <a href="https://clinicaltrials.gov/search?id=%22NCT03700229%22">https://clinicaltrials.gov/search?id=%22NCT03700229%22</a>   |
| CHEMBL1201576 | RITUXIMAB | Antibody | B-lymphocyte antigen CD20 binding agent | Binding agent | MONDO_0020743   | mixed phenotype acute leukemia       | 2 | Recruiting             | <a href="https://clinicaltrials.gov/search?id=%22NCT02135874%22">https://clinicaltrials.gov/search?id=%22NCT02135874%22</a>   |
| CHEMBL1201576 | RITUXIMAB | Antibody | B-lymphocyte antigen CD20 binding agent | Binding agent | MONDO_0021117   | lung neoplasm                        | 2 | Completed              | <a href="https://clinicaltrials.gov/search?id=%22NCT00001805%22">https://clinicaltrials.gov/search?id=%22NCT00001805%22</a>   |
| CHEMBL1201576 | RITUXIMAB | Antibody | B-lymphocyte antigen CD20 binding agent | Binding agent | MONDO_0044917   | T-lymphoblastic lymphoma             | 2 | Withdrawn              | <a href="https://clinicaltrials.gov/search?id=%22NCT02538926%22">https://clinicaltrials.gov/search?id=%22NCT02538926%22</a>   |
| CHEMBL1201576 | RITUXIMAB | Antibody | B-lymphocyte antigen CD20 binding agent | Binding agent | Orphanet_232    | Sickle cell anemia                   | 2 | Terminated             | <a href="https://clinicaltrials.gov/search?id=%22NCT01279616%22">https://clinicaltrials.gov/search?id=%22NCT01279616%22</a>   |
| CHEMBL1201576 | RITUXIMAB | Antibody | B-lymphocyte antigen CD20 binding agent | Binding agent | Orphanet_238510 | Lymphoproliferative syndrome         | 2 | Terminated             | <a href="https://clinicaltrials.gov/search?id=%22NCT00869323%22">https://clinicaltrials.gov/search?id=%22NCT00869323%22</a>   |
| CHEMBL1201576 | RITUXIMAB | Antibody | B-lymphocyte antigen CD20 binding agent | Binding agent | Orphanet_797    | Sarcoidosis                          | 2 | Completed              | <a href="https://clinicaltrials.gov/search?id=%22NCT00855205%22">https://clinicaltrials.gov/search?id=%22NCT00855205%22</a>   |
| CHEMBL1201576 | RITUXIMAB | Antibody | B-lymphocyte antigen CD20 binding agent | Binding agent | Orphanet_98878  | Hemophilia A                         | 2 | Completed              | <a href="https://clinicaltrials.gov/search?id=%22NCT00331006%22">https://clinicaltrials.gov/search?id=%22NCT00331006%22</a>   |
| CHEMBL1201576 | RITUXIMAB | Antibody | B-lymphocyte antigen CD20 binding agent | Binding agent | EFO_0000096     | neoplasm of mature B-cells           | 1 | Suspended              | <a href="https://clinicaltrials.gov/search?id=%22NCT04607772%22">https://clinicaltrials.gov/search?id=%22NCT04607772%22</a>   |
| CHEMBL1201576 | RITUXIMAB | Antibody | B-lymphocyte antigen CD20 binding agent | Binding agent | EFO_0000183     | Hodgkins lymphoma                    | 1 | Withdrawn              | <a href="https://clinicaltrials.gov/search?id=%22NCT02408042%22">https://clinicaltrials.gov/search?id=%22NCT02408042%22</a>   |
| CHEMBL1201576 | RITUXIMAB | Antibody | B-lymphocyte antigen CD20 binding agent | Binding agent | EFO_0000191     | MALT lymphoma                        | 1 | Terminated             | <a href="https://clinicaltrials.gov/search?id=%22NCT00012298%22">https://clinicaltrials.gov/search?id=%22NCT00012298%22</a>   |
| CHEMBL1201576 | RITUXIMAB | Antibody | B-lymphocyte antigen CD20 binding agent | Binding agent | EFO_0000198     | myelodysplastic syndrome             | 1 | Active, not recruiting | <a href="https://clinicaltrials.gov/search?id=%22NCT02960646%22">https://clinicaltrials.gov/search?id=%22NCT02960646%22</a> , <a href="https://clinicaltrials.gov/sea">https://clinicaltrials.gov/sea</a> |
| CHEMBL1201576 | RITUXIMAB | Antibody | B-lymphocyte antigen CD20 binding agent | Binding agent | EFO_0000209     | T-cell acute lymphoblastic leukemia  | 1 | Recruiting             | <a href="https://clinicaltrials.gov/search?id=%22NCT03808610%22">https://clinicaltrials.gov/search?id=%22NCT03808610%22</a>   |
| CHEMBL1201576 | RITUXIMAB | Antibody | B-lymphocyte antigen CD20 binding agent | Binding agent | EFO_0000220     | acute lymphoblastic leukemia         | 1 | Recruiting             | <a href="https://clinicaltrials.gov/search?id=%22NCT01371630%22">https://clinicaltrials.gov/search?id=%22NCT01371630%22</a> , <a href="https://clinicaltrials.gov/sea">https://clinicaltrials.gov/sea</a> |
| CHEMBL1201576 | RITUXIMAB | Antibody | B-lymphocyte antigen CD20 binding agent | Binding agent | EFO_0000222     | acute myeloid leukemia               | 1 | Completed              | <a href="https://clinicaltrials.gov/search?id=%22NCT02779283%22">https://clinicaltrials.gov/search?id=%22NCT02779283%22</a>   |
| CHEMBL1201576 | RITUXIMAB | Antibody | B-lymphocyte antigen CD20 binding agent | Binding agent | EFO_0000304     | breast adenocarcinoma                | 1 | Suspended              | <a href="https://clinicaltrials.gov/search?id=%22NCT03432741%22">https://clinicaltrials.gov/search?id=%22NCT03432741%22</a>   |
| CHEMBL1201576 | RITUXIMAB | Antibody | B-lymphocyte antigen CD20 binding agent | Binding agent | EFO_0000309     | Burkitts lymphoma                    | 1 | Completed              | <a href="https://clinicaltrials.gov/search?id=%22NCT01397825%22">https://clinicaltrials.gov/search?id=%22NCT01397825%22</a> , <a href="https://clinicaltrials.gov/sea">https://clinicaltrials.gov/sea</a> |
| CHEMBL1201576 | RITUXIMAB | Antibody | B-lymphocyte antigen CD20 binding agent | Binding agent | EFO_0000311     | cancer                               | 1 | Active, not recruiting | <a href="https://clinicaltrials.gov/search?id=%22NCT00788684%22">https://clinicaltrials.gov/search?id=%22NCT00788684%22</a> , <a href="https://clinicaltrials.gov/sea">https://clinicaltrials.gov/sea</a> |
| CHEMBL1201576 | RITUXIMAB | Antibody | B-lymphocyte antigen CD20 binding agent | Binding agent | EFO_0000339     | chronic myelogenous leukemia         | 1 | Active, not recruiting | <a href="https://clinicaltrials.gov/search?id=%22NCT01619761%22">https://clinicaltrials.gov/search?id=%22NCT01619761%22</a>   |
| CHEMBL1201576 | RITUXIMAB | Antibody | B-lymphocyte antigen CD20 binding agent | Binding agent | EFO_0000384     | Crohn's disease                      | 1 | Recruiting             | <a href="https://clinicaltrials.gov/search?id=%22NCT00692939%22">https://clinicaltrials.gov/search?id=%22NCT00692939%22</a>   |
| CHEMBL1201576 | RITUXIMAB | Antibody | B-lymphocyte antigen CD20 binding agent | Binding agent | EFO_0000565     | leukemia                             | 1 | Recruiting             | <a href="https://clinicaltrials.gov/search?id=%22NCT02356159%22">https://clinicaltrials.gov/search?id=%22NCT02356159%22</a>   |
| CHEMBL1201576 | RITUXIMAB | Antibody | B-lymphocyte antigen CD20 binding agent | Binding agent | EFO_0000616     | neoplasm                             | 1 | Recruiting             | <a href="https://clinicaltrials.gov/search?id=%22NCT03783403%22">https://clinicaltrials.gov/search?id=%22NCT03783403%22</a>   |
| CHEMBL1201576 | RITUXIMAB | Antibody | B-lymphocyte antigen CD20 binding agent | Binding agent | EFO_0000685     | rheumatoid arthritis                 | 1 | Terminated             | <a href="https://clinicaltrials.gov/search?id=%22NCT03061838%22">https://clinicaltrials.gov/search?id=%22NCT03061838%22</a> , <a href="https://clinicaltrials.gov/sea">https://clinicaltrials.gov/sea</a> |
| CHEMBL1201576 | RITUXIMAB | Antibody | B-lymphocyte antigen CD20 binding agent | Binding agent | EFO_0000692     | schizophrenia                        | 1 | Recruiting             | <a href="https://clinicaltrials.gov/search?id=%22NCT03983018%22">https://clinicaltrials.gov/search?id=%22NCT03983018%22</a>   |
| CHEMBL1201576 | RITUXIMAB | Antibody | B-lymphocyte antigen CD20 binding agent | Binding agent | EFO_0000699     | Sjogren syndrome                     | 1 | Completed              | <a href="https://clinicaltrials.gov/search?id=%22NCT00101829%22">https://clinicaltrials.gov/search?id=%22NCT00101829%22</a> , <a href="https://clinicaltrials.gov/sea">https://clinicaltrials.gov/sea</a> |

|               |           |          |   |               |             |  |                          |   |
|---------------|-----------|----------|---|---------------|-------------|--|--------------------------|---|
| CHEMBL1201576 | RITUXIMAB | Antibody | B-lymphocyte antigen CD20 binding agent | Binding agent | EFO_0000707 | squamous cell carcinoma                | 1 Completed              | <a href="https://clinicaltrials.gov/search?id=%22NCT04361409%22">https://clinicaltrials.gov/search?id=%22NCT04361409%22</a>   |
| CHEMBL1201576 | RITUXIMAB | Antibody | B-lymphocyte antigen CD20 binding agent | Binding agent | EFO_0000768 | idiopathic pulmonary fibrosis          | 1 Completed              | <a href="https://clinicaltrials.gov/search?id=%22NCT01266317%22">https://clinicaltrials.gov/search?id=%22NCT01266317%22</a>   |
| CHEMBL1201576 | RITUXIMAB | Antibody | B-lymphocyte antigen CD20 binding agent | Binding agent | EFO_0001359 | type I diabetes mellitus               | 1 Unknown status         | <a href="https://clinicaltrials.gov/search?id=%22NCT00798785%22">https://clinicaltrials.gov/search?id=%22NCT00798785%22</a>   |
| CHEMBL1201576 | RITUXIMAB | Antibody | B-lymphocyte antigen CD20 binding agent | Binding agent | EFO_0001378 | multiple myeloma                       | 1 Terminated             | <a href="https://clinicaltrials.gov/search?id=%22NCT00176475%22">https://clinicaltrials.gov/search?id=%22NCT00176475%22</a> , <a href="https://clinicaltrials.gov/sea">https://clinicaltrials.gov/sea</a> |
| CHEMBL1201576 | RITUXIMAB | Antibody | B-lymphocyte antigen CD20 binding agent | Binding agent | EFO_0001423 | encephalomyelitis                      | 1 Completed              | <a href="https://clinicaltrials.gov/search?id=%22NCT00259805%22">https://clinicaltrials.gov/search?id=%22NCT00259805%22</a>   |
| CHEMBL1201576 | RITUXIMAB | Antibody | B-lymphocyte antigen CD20 binding agent | Binding agent | EFO_0001642 | lymphoid neoplasm                      | 1 Terminated             | <a href="https://clinicaltrials.gov/search?id=%22NCT01596127%22">https://clinicaltrials.gov/search?id=%22NCT01596127%22</a>   |
| CHEMBL1201576 | RITUXIMAB | Antibody | B-lymphocyte antigen CD20 binding agent | Binding agent | EFO_0002508 | Parkinson's disease                    | 1 Recruiting             | <a href="https://clinicaltrials.gov/search?id=%22NCT04127578%22">https://clinicaltrials.gov/search?id=%22NCT04127578%22</a>   |
| CHEMBL1201576 | RITUXIMAB | Antibody | B-lymphocyte antigen CD20 binding agent | Binding agent | EFO_0002617 | metastatic melanoma                    | 1 Terminated             | <a href="https://clinicaltrials.gov/search?id=%22NCT01032122%22">https://clinicaltrials.gov/search?id=%22NCT01032122%22</a>   |
| CHEMBL1201576 | RITUXIMAB | Antibody | B-lymphocyte antigen CD20 binding agent | Binding agent | EFO_0002690 | systemic lupus erythematosus           | 1 Completed              | <a href="https://clinicaltrials.gov/search?id=%22NCT00036491%22">https://clinicaltrials.gov/search?id=%22NCT00036491%22</a>   |
| CHEMBL1201576 | RITUXIMAB | Antibody | B-lymphocyte antigen CD20 binding agent | Binding agent | EFO_0003778 | psoriatic arthritis                    | 1 Completed              | <a href="https://clinicaltrials.gov/search?id=%22NCT00509678%22">https://clinicaltrials.gov/search?id=%22NCT00509678%22</a>   |
| CHEMBL1201576 | RITUXIMAB | Antibody | B-lymphocyte antigen CD20 binding agent | Binding agent | EFO_0003884 | chronic kidney disease                 | 1 Completed              | <a href="https://clinicaltrials.gov/search?id=%22NCT01178216%22">https://clinicaltrials.gov/search?id=%22NCT01178216%22</a> , <a href="https://clinicaltrials.gov/sea">https://clinicaltrials.gov/sea</a> |
| CHEMBL1201576 | RITUXIMAB | Antibody | B-lymphocyte antigen CD20 binding agent | Binding agent | EFO_0003885 | multiple sclerosis                     | 1 Terminated             | <a href="https://clinicaltrials.gov/search?id=%22NCT01212094%22">https://clinicaltrials.gov/search?id=%22NCT01212094%22</a>   |
| CHEMBL1201576 | RITUXIMAB | Antibody | B-lymphocyte antigen CD20 binding agent | Binding agent | EFO_0004145 | myopathy                               | 1 Terminated             | <a href="https://clinicaltrials.gov/search?id=%22NCT00278564%22">https://clinicaltrials.gov/search?id=%22NCT00278564%22</a>   |
| CHEMBL1201576 | RITUXIMAB | Antibody | B-lymphocyte antigen CD20 binding agent | Binding agent | EFO_0004236 | focal segmental glomerulosclerosis     | 1 Recruiting             | <a href="https://clinicaltrials.gov/search?id=%22NCT03763643%22">https://clinicaltrials.gov/search?id=%22NCT03763643%22</a>   |
| CHEMBL1201576 | RITUXIMAB | Antibody | B-lymphocyte antigen CD20 binding agent | Binding agent | EFO_0004256 | neuromyelitis optica                   | 1 Completed              | <a href="https://clinicaltrials.gov/search?id=%22NCT00787722%22">https://clinicaltrials.gov/search?id=%22NCT00787722%22</a> , <a href="https://clinicaltrials.gov/sea">https://clinicaltrials.gov/sea</a> |
| CHEMBL1201576 | RITUXIMAB | Antibody | B-lymphocyte antigen CD20 binding agent | Binding agent | EFO_0004289 | lymphoid leukemia                      | 1 Completed              | <a href="https://clinicaltrials.gov/search?id=%22NCT00366418%22">https://clinicaltrials.gov/search?id=%22NCT00366418%22</a>   |
| CHEMBL1201576 | RITUXIMAB | Antibody | B-lymphocyte antigen CD20 binding agent | Binding agent | EFO_0004991 | Myasthenia gravis                      | 1 Completed              | <a href="https://clinicaltrials.gov/search?id=%22NCT00619671%22">https://clinicaltrials.gov/search?id=%22NCT00619671%22</a>   |
| CHEMBL1201576 | RITUXIMAB | Antibody | B-lymphocyte antigen CD20 binding agent | Binding agent | EFO_0005140 | autoimmune disease                     | 1 Completed              | <a href="https://clinicaltrials.gov/search?id=%22NCT01086631%22">https://clinicaltrials.gov/search?id=%22NCT01086631%22</a>   |
| CHEMBL1201576 | RITUXIMAB | Antibody | B-lymphocyte antigen CD20 binding agent | Binding agent | EFO_0005297 | Granulomatosis with Polyangiitis       | 1 Completed              | <a href="https://clinicaltrials.gov/search?id=%22NCT00072592%22">https://clinicaltrials.gov/search?id=%22NCT00072592%22</a>   |
| CHEMBL1201576 | RITUXIMAB | Antibody | B-lymphocyte antigen CD20 binding agent | Binding agent | EFO_0005531 | urticaria                              | 1 Terminated             | <a href="https://clinicaltrials.gov/search?id=%22NCT00216762%22">https://clinicaltrials.gov/search?id=%22NCT00216762%22</a>   |
| CHEMBL1201576 | RITUXIMAB | Antibody | B-lymphocyte antigen CD20 binding agent | Binding agent | EFO_0005952 | non-Hodgkins Lymphoma                  | 1 Recruiting             | <a href="https://clinicaltrials.gov/search?id=%22NCT04673617%22">https://clinicaltrials.gov/search?id=%22NCT04673617%22</a> , <a href="https://clinicaltrials.gov/sea">https://clinicaltrials.gov/sea</a> |
| CHEMBL1201576 | RITUXIMAB | Antibody | B-lymphocyte antigen CD20 binding agent | Binding agent | EFO_0007160 | autoimmune thrombocytopenic purpu      | 1 Completed              | <a href="https://clinicaltrials.gov/search?id=%22NCT01713738%22">https://clinicaltrials.gov/search?id=%22NCT01713738%22</a>   |
| CHEMBL1201576 | RITUXIMAB | Antibody | B-lymphocyte antigen CD20 binding agent | Binding agent | EFO_0007187 | bullous pemphigoid                     | 1 Completed              | <a href="https://clinicaltrials.gov/search?id=%22NCT00286325%22">https://clinicaltrials.gov/search?id=%22NCT00286325%22</a>   |
| CHEMBL1201576 | RITUXIMAB | Antibody | B-lymphocyte antigen CD20 binding agent | Binding agent | EFO_0007498 | Stiff-Person syndrome                  | 1 Terminated             | <a href="https://clinicaltrials.gov/search?id=%22NCT02282514%22">https://clinicaltrials.gov/search?id=%22NCT02282514%22</a>   |
| CHEMBL1201576 | RITUXIMAB | Antibody | B-lymphocyte antigen CD20 binding agent | Binding agent | EFO_0008520 | primary progressive multiple sclerosis | 1 Completed              | <a href="https://clinicaltrials.gov/search?id=%22NCT02253264%22">https://clinicaltrials.gov/search?id=%22NCT02253264%22</a>   |
| CHEMBL1201576 | RITUXIMAB | Antibody | B-lymphocyte antigen CD20 binding agent | Binding agent | EFO_0008522 | secondary progressive multiple sclero: | 1 Completed              | <a href="https://clinicaltrials.gov/search?id=%22NCT02253264%22">https://clinicaltrials.gov/search?id=%22NCT02253264%22</a>   |
| CHEMBL1201576 | RITUXIMAB | Antibody | B-lymphocyte antigen CD20 binding agent | Binding agent | EFO_0008610 | ocular cicatricial pemphigoid          | 1 Completed              | <a href="https://clinicaltrials.gov/search?id=%22NCT00584935%22">https://clinicaltrials.gov/search?id=%22NCT00584935%22</a>   |
| CHEMBL1201576 | RITUXIMAB | Antibody | B-lymphocyte antigen CD20 binding agent | Binding agent | EFO_0009606 | macular degeneration                   | 1 Completed              | <a href="https://clinicaltrials.gov/search?id=%22NCT02332941%22">https://clinicaltrials.gov/search?id=%22NCT02332941%22</a>   |
| CHEMBL1201576 | RITUXIMAB | Antibody | B-lymphocyte antigen CD20 binding agent | Binding agent | EFO_1000131 | Blast Phase Chronic Myelogenous Leu    | 1 Active, not recruiting | <a href="https://clinicaltrials.gov/search?id=%22NCT02960646%22">https://clinicaltrials.gov/search?id=%22NCT02960646%22</a>   |
| CHEMBL1201576 | RITUXIMAB | Antibody | B-lymphocyte antigen CD20 binding agent | Binding agent | EFO_1000550 | Splenic Marginal Zone Lymphoma         | 1 Completed              | <a href="https://clinicaltrials.gov/search?id=%22NCT00438880%22">https://clinicaltrials.gov/search?id=%22NCT00438880%22</a>   |
| CHEMBL1201576 | RITUXIMAB | Antibody | B-lymphocyte antigen CD20 binding agent | Binding agent | EFO_1000956 | hairy cell leukemia                    | 1 Recruiting             | <a href="https://clinicaltrials.gov/search?id=%22NCT03805932%22">https://clinicaltrials.gov/search?id=%22NCT03805932%22</a>   |
| CHEMBL1201576 | RITUXIMAB | Antibody | B-lymphocyte antigen CD20 binding agent | Binding agent | EFO_1001051 | mycosis fungoides                      | 1 Suspended              | <a href="https://clinicaltrials.gov/search?id=%22NCT03432741%22">https://clinicaltrials.gov/search?id=%22NCT03432741%22</a>   |

|               |           |          |   |               |                 |  |   |                        |   |
|---------------|-----------|----------|---|---------------|-----------------|--|---|------------------------|---|
| CHEMBL1201576 | RITUXIMAB | Antibody | B-lymphocyte antigen CD20 binding agent | Binding agent | EFO_1001365     | Lymphoma, AIDS-Related                 | 1 | Terminated             | <a href="https://clinicaltrials.gov/search?id=%22NCT00036855%22">https://clinicaltrials.gov/search?id=%22NCT00036855%22</a>   |
| CHEMBL1201576 | RITUXIMAB | Antibody | B-lymphocyte antigen CD20 binding agent | Binding agent | EFO_1001383     | Opsoclonus-Myoclonus Syndrome          | 1 | Completed              | <a href="https://clinicaltrials.gov/search?id=%22NCT00244361%22">https://clinicaltrials.gov/search?id=%22NCT00244361%22</a>   |
| CHEMBL1201576 | RITUXIMAB | Antibody | B-lymphocyte antigen CD20 binding agent | Binding agent | EFO_1001466     | Graves ophthalmopathy                  | 1 | Completed              | <a href="https://clinicaltrials.gov/search?id=%22NCT00150111%22">https://clinicaltrials.gov/search?id=%22NCT00150111%22</a> , <a href="https://clinicaltrials.gov/sea">https://clinicaltrials.gov/sea</a> |
| CHEMBL1201576 | RITUXIMAB | Antibody | B-lymphocyte antigen CD20 binding agent | Binding agent | EFO_1001486     | primary biliary cirrhosis              | 1 | Completed              | <a href="https://clinicaltrials.gov/search?id=%22NCT00364819%22">https://clinicaltrials.gov/search?id=%22NCT00364819%22</a>   |
| CHEMBL1201576 | RITUXIMAB | Antibody | B-lymphocyte antigen CD20 binding agent | Binding agent | EFO_1001779     | chronic myelomonocytic leukemia        | 1 | Active, not recruiting | <a href="https://clinicaltrials.gov/search?id=%22NCT02960646%22">https://clinicaltrials.gov/search?id=%22NCT02960646%22</a>   |
| CHEMBL1201576 | RITUXIMAB | Antibody | B-lymphocyte antigen CD20 binding agent | Binding agent | EFO_1002048     | kidney failure                         | 1 | Not yet recruiting     | <a href="https://clinicaltrials.gov/search?id=%22NCT04540380%22">https://clinicaltrials.gov/search?id=%22NCT04540380%22</a>   |
| CHEMBL1201576 | RITUXIMAB | Antibody | B-lymphocyte antigen CD20 binding agent | Binding agent | HP_0001871      | Abnormality of blood and blood-formi   | 1 | Not yet recruiting     | <a href="https://clinicaltrials.gov/search?id=%22NCT04243434%22">https://clinicaltrials.gov/search?id=%22NCT04243434%22</a>   |
| CHEMBL1201576 | RITUXIMAB | Antibody | B-lymphocyte antigen CD20 binding agent | Binding agent | HP_0001915      | Aplastic anemia                        | 1 | Active, not recruiting | <a href="https://clinicaltrials.gov/search?id=%22NCT02960646%22">https://clinicaltrials.gov/search?id=%22NCT02960646%22</a>   |
| CHEMBL1201576 | RITUXIMAB | Antibody | B-lymphocyte antigen CD20 binding agent | Binding agent | MONDO_0000873   | lymphoblastic lymphoma                 | 1 | Active, not recruiting | <a href="https://clinicaltrials.gov/search?id=%22NCT02960646%22">https://clinicaltrials.gov/search?id=%22NCT02960646%22</a>   |
| CHEMBL1201576 | RITUXIMAB | Antibody | B-lymphocyte antigen CD20 binding agent | Binding agent | MONDO_0001023   | prolymphocytic leukemia                | 1 | Active, not recruiting | <a href="https://clinicaltrials.gov/search?id=%22NCT02296918%22">https://clinicaltrials.gov/search?id=%22NCT02296918%22</a>   |
| CHEMBL1201576 | RITUXIMAB | Antibody | B-lymphocyte antigen CD20 binding agent | Binding agent | MONDO_0001437   | pulmonary alveolar proteinosis         | 1 | Completed              | <a href="https://clinicaltrials.gov/search?id=%22NCT01842386%22">https://clinicaltrials.gov/search?id=%22NCT01842386%22</a>   |
| CHEMBL1201576 | RITUXIMAB | Antibody | B-lymphocyte antigen CD20 binding agent | Binding agent | MONDO_0001718   | scleritis                              | 1 | Completed              | <a href="https://clinicaltrials.gov/search?id=%22NCT00415506%22">https://clinicaltrials.gov/search?id=%22NCT00415506%22</a>   |
| CHEMBL1201576 | RITUXIMAB | Antibody | B-lymphocyte antigen CD20 binding agent | Binding agent | MONDO_0002083   | Richter syndrome                       | 1 | Completed              | <a href="https://clinicaltrials.gov/search?id=%22NCT00472849%22">https://clinicaltrials.gov/search?id=%22NCT00472849%22</a>   |
| CHEMBL1201576 | RITUXIMAB | Antibody | B-lymphocyte antigen CD20 binding agent | Binding agent | MONDO_0002334   | hematopoietic and lymphoid system n    | 1 | Recruiting             | <a href="https://clinicaltrials.gov/search?id=%22NCT04022239%22">https://clinicaltrials.gov/search?id=%22NCT04022239%22</a>   |
| CHEMBL1201576 | RITUXIMAB | Antibody | B-lymphocyte antigen CD20 binding agent | Binding agent | MONDO_0002462   | glomerulonephritis                     | 1 | Completed              | <a href="https://clinicaltrials.gov/search?id=%22NCT00275613%22">https://clinicaltrials.gov/search?id=%22NCT00275613%22</a>   |
| CHEMBL1201576 | RITUXIMAB | Antibody | B-lymphocyte antigen CD20 binding agent | Binding agent | MONDO_0004095   | B-cell neoplasm                        | 1 | Recruiting             | <a href="https://clinicaltrials.gov/search?id=%22NCT02911142%22">https://clinicaltrials.gov/search?id=%22NCT02911142%22</a>   |
| CHEMBL1201576 | RITUXIMAB | Antibody | B-lymphocyte antigen CD20 binding agent | Binding agent | MONDO_0013730   | graft versus host disease              | 1 | Recruiting             | <a href="https://clinicaltrials.gov/search?id=%22NCT03689894%22">https://clinicaltrials.gov/search?id=%22NCT03689894%22</a>   |
| CHEMBL1201576 | RITUXIMAB | Antibody | B-lymphocyte antigen CD20 binding agent | Binding agent | MONDO_0015564   | Castleman disease                      | 1 | Withdrawn              | <a href="https://clinicaltrials.gov/search?id=%22NCT02228512%22">https://clinicaltrials.gov/search?id=%22NCT02228512%22</a>   |
| CHEMBL1201576 | RITUXIMAB | Antibody | B-lymphocyte antigen CD20 binding agent | Binding agent | MONDO_0015760   | T-cell non-Hodgkin lymphoma            | 1 | Recruiting             | <a href="https://clinicaltrials.gov/search?id=%22NCT01701986%22">https://clinicaltrials.gov/search?id=%22NCT01701986%22</a>   |
| CHEMBL1201576 | RITUXIMAB | Antibody | B-lymphocyte antigen CD20 binding agent | Binding agent | MONDO_0018896   | thrombotic thrombocytopenic purpura    | 1 | Withdrawn              | <a href="https://clinicaltrials.gov/search?id=%22NCT00251277%22">https://clinicaltrials.gov/search?id=%22NCT00251277%22</a>   |
| CHEMBL1201576 | RITUXIMAB | Antibody | B-lymphocyte antigen CD20 binding agent | Binding agent | MONDO_0019088   | post-transplant lymphoproliferative d  | 1 | Terminated             | <a href="https://clinicaltrials.gov/search?id=%22NCT00036855%22">https://clinicaltrials.gov/search?id=%22NCT00036855%22</a>   |
| CHEMBL1201576 | RITUXIMAB | Antibody | B-lymphocyte antigen CD20 binding agent | Binding agent | MONDO_0019457   | therapy related acute myeloid leukem   | 1 | Active, not recruiting | <a href="https://clinicaltrials.gov/search?id=%22NCT01619761%22">https://clinicaltrials.gov/search?id=%22NCT01619761%22</a>   |
| CHEMBL1201576 | RITUXIMAB | Antibody | B-lymphocyte antigen CD20 binding agent | Binding agent | MONDO_0019465   | nodal marginal zone B-cell lymphoma    | 1 | Terminated             | <a href="https://clinicaltrials.gov/search?id=%22NCT00012298%22">https://clinicaltrials.gov/search?id=%22NCT00012298%22</a>   |
| CHEMBL1201576 | RITUXIMAB | Antibody | B-lymphocyte antigen CD20 binding agent | Binding agent | MONDO_0024880   | metastatic malignant neoplasm          | 1 | Terminated             | <a href="https://clinicaltrials.gov/search?id=%22NCT01596127%22">https://clinicaltrials.gov/search?id=%22NCT01596127%22</a>   |
| CHEMBL1201576 | RITUXIMAB | Antibody | B-lymphocyte antigen CD20 binding agent | Binding agent | MONDO_0044881   | hematopoietic and lymphoid cell neop   | 1 | Active, not recruiting | <a href="https://clinicaltrials.gov/search?id=%22NCT02367196%22">https://clinicaltrials.gov/search?id=%22NCT02367196%22</a> , <a href="https://clinicaltrials.gov/sea">https://clinicaltrials.gov/sea</a> |
| CHEMBL1201576 | RITUXIMAB | Antibody | B-lymphocyte antigen CD20 binding agent | Binding agent | MONDO_0044887   | central nervous system non-hodgkin l   | 1 | Recruiting             | <a href="https://clinicaltrials.gov/search?id=%22NCT02315326%22">https://clinicaltrials.gov/search?id=%22NCT02315326%22</a> , <a href="https://clinicaltrials.gov/sea">https://clinicaltrials.gov/sea</a> |
| CHEMBL1201576 | RITUXIMAB | Antibody | B-lymphocyte antigen CD20 binding agent | Binding agent | MONDO_0044889   | high grade B-cell lymphoma             | 1 | Active, not recruiting | <a href="https://clinicaltrials.gov/search?id=%22NCT03742258%22">https://clinicaltrials.gov/search?id=%22NCT03742258%22</a> , <a href="https://clinicaltrials.gov/sea">https://clinicaltrials.gov/sea</a> |
| CHEMBL1201576 | RITUXIMAB | Antibody | B-lymphocyte antigen CD20 binding agent | Binding agent | Orphanet_1334   | Chronic mucocutaneous candidosis       | 1 | Completed              | <a href="https://clinicaltrials.gov/search?id=%22NCT01842386%22">https://clinicaltrials.gov/search?id=%22NCT01842386%22</a>   |
| CHEMBL1201576 | RITUXIMAB | Antibody | B-lymphocyte antigen CD20 binding agent | Binding agent | Orphanet_282    | Frontotemporal dementia                | 1 | Recruiting             | <a href="https://clinicaltrials.gov/search?id=%22NCT04408625%22">https://clinicaltrials.gov/search?id=%22NCT04408625%22</a>   |
| CHEMBL1201576 | RITUXIMAB | Antibody | B-lymphocyte antigen CD20 binding agent | Binding agent | Orphanet_309144 | Gangliosidosis                         | 1 | Recruiting             | <a href="https://clinicaltrials.gov/search?id=%22NCT03952637%22">https://clinicaltrials.gov/search?id=%22NCT03952637%22</a>   |
| CHEMBL1201576 | RITUXIMAB | Antibody | B-lymphocyte antigen CD20 binding agent | Binding agent | Orphanet_365    | Glycogen storage disease due to acid r | 1 | Active, not recruiting | <a href="https://clinicaltrials.gov/search?id=%22NCT02240407%22">https://clinicaltrials.gov/search?id=%22NCT02240407%22</a>   |
| CHEMBL1201576 | RITUXIMAB | Antibody | B-lymphocyte antigen CD20 binding agent | Binding agent | Orphanet_84     | Fanconi anemia                         | 1 | Not yet recruiting     | <a href="https://clinicaltrials.gov/search?id=%22NCT04784052%22">https://clinicaltrials.gov/search?id=%22NCT04784052%22</a>   |

|               |                         |          |   |                    |               |                                     |                          |   |
|---------------|-------------------------|----------|---|--------------------|---------------|-------------------------------------|--------------------------|---|
| CHEMBL1201576 | RITUXIMAB               | Antibody | B-lymphocyte antigen CD20 binding agent                     | Binding agent      | EFO_0000095   | chronic lymphocytic leukemia        | 0 Completed              | <a href="https://clinicaltrials.gov/search?id=%22NCT00017381%22">https://clinicaltrials.gov/search?id=%22NCT00017381%22</a>   |
| CHEMBL1201576 | RITUXIMAB               | Antibody | B-lymphocyte antigen CD20 binding agent                     | Binding agent      | EFO_0000403   | diffuse large B-cell lymphoma       | 0 Completed              | <a href="https://clinicaltrials.gov/search?id=%22NCT00017381%22">https://clinicaltrials.gov/search?id=%22NCT00017381%22</a>   |
| CHEMBL1201576 | RITUXIMAB               | Antibody | B-lymphocyte antigen CD20 binding agent                     | Binding agent      | EFO_0000574   | lymphoma                            | 0 Terminated             | <a href="https://clinicaltrials.gov/search?id=%22NCT00515138%22">https://clinicaltrials.gov/search?id=%22NCT00515138%22</a>   |
| CHEMBL1201576 | RITUXIMAB               | Antibody | B-lymphocyte antigen CD20 binding agent                     | Binding agent      | EFO_0000621   | neuroblastoma                       | 0 Active, not recruiting | <a href="https://clinicaltrials.gov/search?id=%22NCT00790413%22">https://clinicaltrials.gov/search?id=%22NCT00790413%22</a>   |
| CHEMBL1201576 | RITUXIMAB               | Antibody | B-lymphocyte antigen CD20 binding agent                     | Binding agent      | EFO_0003086   | kidney disease                      | 0 Completed              | <a href="https://clinicaltrials.gov/search?id=%22NCT00405340%22">https://clinicaltrials.gov/search?id=%22NCT00405340%22</a>   |
| CHEMBL1201576 | RITUXIMAB               | Antibody | B-lymphocyte antigen CD20 binding agent                     | Binding agent      | EFO_0009441   | Waldenstrom macroglobulinemia       | 0 Completed              | <a href="https://clinicaltrials.gov/search?id=%22NCT00017381%22">https://clinicaltrials.gov/search?id=%22NCT00017381%22</a>   |
| CHEMBL1201576 | RITUXIMAB               | Antibody | B-lymphocyte antigen CD20 binding agent                     | Binding agent      | EFO_1000157   | Central Nervous System Lymphoma     | 0 Recruiting             | <a href="https://clinicaltrials.gov/search?id=%22NCT03684980%22">https://clinicaltrials.gov/search?id=%22NCT03684980%22</a>   |
| CHEMBL1201576 | RITUXIMAB               | Antibody | B-lymphocyte antigen CD20 binding agent                     | Binding agent      | EFO_1000630   | marginal zone B-cell lymphoma       | 0 Completed              | <a href="https://clinicaltrials.gov/search?id=%22NCT00017381%22">https://clinicaltrials.gov/search?id=%22NCT00017381%22</a>   |
| CHEMBL1201576 | RITUXIMAB               | Antibody | B-lymphocyte antigen CD20 binding agent                     | Binding agent      | EFO_1001469   | Mantle cell lymphoma                | 0 Active, not recruiting | <a href="https://clinicaltrials.gov/search?id=%22NCT03295240%22">https://clinicaltrials.gov/search?id=%22NCT03295240%22</a>   |
| CHEMBL1201576 | RITUXIMAB               | Antibody | B-lymphocyte antigen CD20 binding agent                     | Binding agent      | MONDO_0008315 | prostate cancer                     | 0 Unknown status         | <a href="https://clinicaltrials.gov/search?id=%22NCT01804712%22">https://clinicaltrials.gov/search?id=%22NCT01804712%22</a>   |
| CHEMBL1201576 | RITUXIMAB               | Antibody | B-lymphocyte antigen CD20 binding agent                     | Binding agent      | MONDO_0018906 | follicular lymphoma                 | 0 Completed              | <a href="https://clinicaltrials.gov/search?id=%22NCT00017381%22">https://clinicaltrials.gov/search?id=%22NCT00017381%22</a>   |
| CHEMBL4297819 | ROPEGINTERFERON ALFA-2B | Unknown  | Interferon alpha/beta receptor positive modulator           | Positive modulator | EFO_0000479   | essential thrombocythemia           | 3 Recruiting             | <a href="https://clinicaltrials.gov/search?id=%22NCT04285086%22">https://clinicaltrials.gov/search?id=%22NCT04285086%22</a>   |
| CHEMBL4297819 | ROPEGINTERFERON ALFA-2B | Unknown  | Interferon alpha/beta receptor positive modulator           | Positive modulator | EFO_0002429   | polycythemia vera                   | 2 Active, not recruiting | <a href="https://clinicaltrials.gov/search?id=%22NCT04182100%22">https://clinicaltrials.gov/search?id=%22NCT04182100%22</a> , <a href="https://clinicaltrials.gov/sea">https://clinicaltrials.gov/sea</a> |
| CHEMBL4297819 | ROPEGINTERFERON ALFA-2B | Unknown  | Interferon alpha/beta receptor positive modulator           | Positive modulator | EFO_0000182   | hepatocellular carcinoma            | 1 Recruiting             | <a href="https://clinicaltrials.gov/search?id=%22NCT04233840%22">https://clinicaltrials.gov/search?id=%22NCT04233840%22</a>   |
| CHEMBL4297819 | ROPEGINTERFERON ALFA-2B | Unknown  | Interferon alpha/beta receptor positive modulator           | Positive modulator | EFO_0000339   | chronic myelogenous leukemia        | 1 Completed              | <a href="https://clinicaltrials.gov/search?id=%22NCT01933906%22">https://clinicaltrials.gov/search?id=%22NCT01933906%22</a>   |
| CHEMBL4297819 | ROPEGINTERFERON ALFA-2B | Unknown  | Interferon alpha/beta receptor positive modulator           | Positive modulator | EFO_0004220   | chronic hepatitis C virus infection | 1 Recruiting             | <a href="https://clinicaltrials.gov/search?id=%22NCT04774107%22">https://clinicaltrials.gov/search?id=%22NCT04774107%22</a>   |
| CHEMBL4297819 | ROPEGINTERFERON ALFA-2B | Unknown  | Interferon alpha/beta receptor positive modulator           | Positive modulator | EFO_0004239   | chronic hepatitis B virus infection | 1 Not yet recruiting     | <a href="https://clinicaltrials.gov/search?id=%22NCT04638439%22">https://clinicaltrials.gov/search?id=%22NCT04638439%22</a>   |
| CHEMBL4297819 | ROPEGINTERFERON ALFA-2B | Unknown  | Interferon alpha/beta receptor positive modulator           | Positive modulator | EFO_0007304   | hepatitis D virus infection         | 1 Not yet recruiting     | <a href="https://clinicaltrials.gov/search?id=%22NCT04638439%22">https://clinicaltrials.gov/search?id=%22NCT04638439%22</a>   |
| CHEMBL2109477 | SELICRELUMAB            | Antibody | Tumor necrosis factor receptor superfamily member 5 agonist | Agonist            | EFO_0000096   | neoplasm of mature B-cells          | 1 Terminated             | <a href="https://clinicaltrials.gov/search?id=%22NCT03892525%22">https://clinicaltrials.gov/search?id=%22NCT03892525%22</a>   |
| CHEMBL2109477 | SELICRELUMAB            | Antibody | Tumor necrosis factor receptor superfamily member 5 agonist | Agonist            | EFO_0000756   | melanoma                            | 1 Completed              | <a href="https://clinicaltrials.gov/search?id=%22NCT01103635%22">https://clinicaltrials.gov/search?id=%22NCT01103635%22</a> , <a href="https://clinicaltrials.gov/sea">https://clinicaltrials.gov/sea</a> |
| CHEMBL2109477 | SELICRELUMAB            | Antibody | Tumor necrosis factor receptor superfamily member 5 agonist | Agonist            | EFO_0003860   | pancreatic neoplasm                 | 1 Completed              | <a href="https://clinicaltrials.gov/search?id=%22NCT00711191%22">https://clinicaltrials.gov/search?id=%22NCT00711191%22</a>   |
| CHEMBL2109477 | SELICRELUMAB            | Antibody | Tumor necrosis factor receptor superfamily member 5 agonist | Agonist            | EFO_1000044   | pancreatic adenocarcinoma           | 1 Completed              | <a href="https://clinicaltrials.gov/search?id=%22NCT01456585%22">https://clinicaltrials.gov/search?id=%22NCT01456585%22</a>   |
| CHEMBL2109477 | SELICRELUMAB            | Antibody | Tumor necrosis factor receptor superfamily member 5 agonist | Agonist            | EFO_1001951   | colorectal carcinoma                | 1 Recruiting             | <a href="https://clinicaltrials.gov/search?id=%22NCT03555149%22">https://clinicaltrials.gov/search?id=%22NCT03555149%22</a>   |
| CHEMBL2109477 | SELICRELUMAB            | Antibody | Tumor necrosis factor receptor superfamily member 5 agonist | Agonist            | MONDO_0007254 | breast cancer                       | 1 Recruiting             | <a href="https://clinicaltrials.gov/search?id=%22NCT03424005%22">https://clinicaltrials.gov/search?id=%22NCT03424005%22</a>   |
| CHEMBL2109477 | SELICRELUMAB            | Antibody | Tumor necrosis factor receptor superfamily member 5 agonist | Agonist            | EFO_0000616   | neoplasm                            | 0 Completed              | <a href="https://clinicaltrials.gov/search?id=%22NCT02157831%22">https://clinicaltrials.gov/search?id=%22NCT02157831%22</a>   |
| CHEMBL4298047 | TAFASITAMAB             | Antibody | B-lymphocyte antigen CD19 binding agent                     | Binding agent      | EFO_0000616   | neoplasm                            | 4                        | <a href="http://www.whocc.no/atc_ddd_index/?code=L01XC35">http://www.whocc.no/atc_ddd_index/?code=L01XC35</a>   |
| CHEMBL4298047 | TAFASITAMAB             | Antibody | B-lymphocyte antigen CD19 binding agent                     | Binding agent      | MONDO_0018906 | follicular lymphoma                 | 3 Recruiting             | <a href="https://clinicaltrials.gov/search?id=%22NCT04680052%22">https://clinicaltrials.gov/search?id=%22NCT04680052%22</a>   |
| CHEMBL4298047 | TAFASITAMAB             | Antibody | B-lymphocyte antigen CD19 binding agent                     | Binding agent      | EFO_0000220   | acute lymphoblastic leukemia        | 2 Terminated             | <a href="https://clinicaltrials.gov/search?id=%22NCT01685021%22">https://clinicaltrials.gov/search?id=%22NCT01685021%22</a>   |
| CHEMBL4298047 | TAFASITAMAB             | Antibody | B-lymphocyte antigen CD19 binding agent                     | Binding agent      | EFO_0005952   | non-Hodgkins lymphoma               | 2 Active, not recruiting | <a href="https://clinicaltrials.gov/search?id=%22NCT01685008%22">https://clinicaltrials.gov/search?id=%22NCT01685008%22</a>   |
| CHEMBL4298047 | TAFASITAMAB             | Antibody | B-lymphocyte antigen CD19 binding agent                     | Binding agent      | MONDO_0001023 | prolymphocytic leukemia             | 2 Active, not recruiting | <a href="https://clinicaltrials.gov/search?id=%22NCT02005289%22">https://clinicaltrials.gov/search?id=%22NCT02005289%22</a>   |
| CHEMBL4298047 | TAFASITAMAB             | Antibody | B-lymphocyte antigen CD19 binding agent                     | Binding agent      | EFO_0000095   | chronic lymphocytic leukemia        | 1 Completed              | <a href="https://clinicaltrials.gov/search?id=%22NCT01161511%22">https://clinicaltrials.gov/search?id=%22NCT01161511%22</a>   |
| CHEMBL4298047 | TAFASITAMAB             | Antibody | B-lymphocyte antigen CD19 binding agent                     | Binding agent      | EFO_0000096   | neoplasm of mature B-cells          | 1 Suspended              | <a href="https://clinicaltrials.gov/search?id=%22NCT04607772%22">https://clinicaltrials.gov/search?id=%22NCT04607772%22</a>   |

|               |                  |          |   |               |               |                                     |   |                        |   |
|---------------|------------------|----------|---|---------------|---------------|-------------------------------------|---|------------------------|---|
| CHEMBL4298047 | TAFASITAMAB      | Antibody | B-lymphocyte antigen CD19 binding agent | Binding agent | EFO_0000403   | diffuse large B-cell lymphoma       | 1 | Active, not recruiting | <a href="https://clinicaltrials.gov/search?id=%22NCT04134936%22">https://clinicaltrials.gov/search?id=%22NCT04134936%22</a>   |
| CHEMBL4298047 | TAFASITAMAB      | Antibody | B-lymphocyte antigen CD19 binding agent | Binding agent | EFO_0000574   | lymphoma                            | 1 | Not yet recruiting     | <a href="https://clinicaltrials.gov/search?id=%22NCT04882163%22">https://clinicaltrials.gov/search?id=%22NCT04882163%22</a>   |
| CHEMBL3301574 | TISAGENLECLEUCEL | Cell     | B-lymphocyte antigen CD19 binding agent | Binding agent | EFO_0000616   | neoplasm                            | 4 |                        | <a href="http://www.whocc.no/atc_ddd_index/?code=L01XX71">http://www.whocc.no/atc_ddd_index/?code=L01XX71</a>   |
| CHEMBL3301574 | TISAGENLECLEUCEL | Cell     | B-lymphocyte antigen CD19 binding agent | Binding agent | EFO_0000096   | neoplasm of mature B-cells          | 2 | Unknown status         | <a href="https://clinicaltrials.gov/search?id=%22NCT03391726%22">https://clinicaltrials.gov/search?id=%22NCT03391726%22</a>   |
| CHEMBL3301574 | TISAGENLECLEUCEL | Cell     | B-lymphocyte antigen CD19 binding agent | Binding agent | EFO_0004289   | lymphoid leukemia                   | 2 | Active, not recruiting | <a href="https://clinicaltrials.gov/search?id=%22NCT02435849%22">https://clinicaltrials.gov/search?id=%22NCT02435849%22</a>   |
| CHEMBL3301574 | TISAGENLECLEUCEL | Cell     | B-lymphocyte antigen CD19 binding agent | Binding agent | EFO_0005952   | non-Hodgkins lymphoma               | 2 | Active, not recruiting | <a href="https://clinicaltrials.gov/search?id=%22NCT03610724%22">https://clinicaltrials.gov/search?id=%22NCT03610724%22</a>   |
| CHEMBL3301574 | TISAGENLECLEUCEL | Cell     | B-lymphocyte antigen CD19 binding agent | Binding agent | EFO_1001469   | Mantle cell lymphoma                | 2 | Recruiting             | <a href="https://clinicaltrials.gov/search?id=%22NCT04234061%22">https://clinicaltrials.gov/search?id=%22NCT04234061%22</a>   |
| CHEMBL3301574 | TISAGENLECLEUCEL | Cell     | B-lymphocyte antigen CD19 binding agent | Binding agent | MONDO_0000873 | lymphoblastic lymphoma              | 2 | Unknown status         | <a href="https://clinicaltrials.gov/search?id=%22NCT03321123%22">https://clinicaltrials.gov/search?id=%22NCT03321123%22</a>   |
| CHEMBL3301574 | TISAGENLECLEUCEL | Cell     | B-lymphocyte antigen CD19 binding agent | Binding agent | MONDO_0018906 | follicular lymphoma                 | 2 | Active, not recruiting | <a href="https://clinicaltrials.gov/search?id=%22NCT03568461%22">https://clinicaltrials.gov/search?id=%22NCT03568461%22</a>   |
| CHEMBL3301574 | TISAGENLECLEUCEL | Cell     | B-lymphocyte antigen CD19 binding agent | Binding agent | EFO_0000094   | B-cell acute lymphoblastic leukemia | 1 | Unknown status         | <a href="https://clinicaltrials.gov/search?id=%22NCT02924753%22">https://clinicaltrials.gov/search?id=%22NCT02924753%22</a>   |
| CHEMBL3301574 | TISAGENLECLEUCEL | Cell     | B-lymphocyte antigen CD19 binding agent | Binding agent | EFO_0000095   | chronic lymphocytic leukemia        | 1 | Recruiting             | <a href="https://clinicaltrials.gov/search?id=%22NCT03853616%22">https://clinicaltrials.gov/search?id=%22NCT03853616%22</a>   |
| CHEMBL3301574 | TISAGENLECLEUCEL | Cell     | B-lymphocyte antigen CD19 binding agent | Binding agent | EFO_0000220   | acute lymphoblastic leukemia        | 1 | Terminated             | <a href="https://clinicaltrials.gov/search?id=%22NCT01551043%22">https://clinicaltrials.gov/search?id=%22NCT01551043%22</a>   |
| CHEMBL3301574 | TISAGENLECLEUCEL | Cell     | B-lymphocyte antigen CD19 binding agent | Binding agent | EFO_0000222   | acute myeloid leukemia              | 1 | Recruiting             | <a href="https://clinicaltrials.gov/search?id=%22NCT03896854%22">https://clinicaltrials.gov/search?id=%22NCT03896854%22</a>   |
| CHEMBL3301574 | TISAGENLECLEUCEL | Cell     | B-lymphocyte antigen CD19 binding agent | Binding agent | EFO_0000565   | leukemia                            | 1 | Recruiting             | <a href="https://clinicaltrials.gov/search?id=%22NCT03614858%22">https://clinicaltrials.gov/search?id=%22NCT03614858%22</a>   |
| CHEMBL3301574 | TISAGENLECLEUCEL | Cell     | B-lymphocyte antigen CD19 binding agent | Binding agent | EFO_0001378   | multiple myeloma                    | 1 | Completed              | <a href="https://clinicaltrials.gov/search?id=%22NCT02135406%22">https://clinicaltrials.gov/search?id=%22NCT02135406%22</a>   |
| CHEMBL3301574 | TISAGENLECLEUCEL | Cell     | B-lymphocyte antigen CD19 binding agent | Binding agent | EFO_1000157   | Central Nervous System Lymphoma     | 1 | Recruiting             | <a href="https://clinicaltrials.gov/search?id=%22NCT04134117%22">https://clinicaltrials.gov/search?id=%22NCT04134117%22</a>   |
| CHEMBL3301574 | TISAGENLECLEUCEL | Cell     | B-lymphocyte antigen CD19 binding agent | Binding agent | EFO_0000183   | Hodgkins lymphoma                   | 0 | Terminated             | <a href="https://clinicaltrials.gov/search?id=%22NCT02624258%22">https://clinicaltrials.gov/search?id=%22NCT02624258%22</a>   |
| CHEMBL3301574 | TISAGENLECLEUCEL | Cell     | B-lymphocyte antigen CD19 binding agent | Binding agent | EFO_0000403   | diffuse large B-cell lymphoma       | 0 | Not yet recruiting     | <a href="https://clinicaltrials.gov/search?id=%22NCT04890236%22">https://clinicaltrials.gov/search?id=%22NCT04890236%22</a>   |
| CHEMBL3301574 | TISAGENLECLEUCEL | Cell     | B-lymphocyte antigen CD19 binding agent | Binding agent | EFO_0000574   | lymphoma                            | 0 | Completed              | <a href="https://clinicaltrials.gov/search?id=%22NCT02476734%22">https://clinicaltrials.gov/search?id=%22NCT02476734%22</a>   |
| CHEMBL3301574 | TISAGENLECLEUCEL | Cell     | B-lymphocyte antigen CD19 binding agent | Binding agent | EFO_0002618   | pancreatic carcinoma                | 0 | Unknown status         | <a href="https://clinicaltrials.gov/search?id=%22NCT03497819%22">https://clinicaltrials.gov/search?id=%22NCT03497819%22</a>   |
| CHEMBL1201604 | TOSITUMOMAB      | Antibody | B-lymphocyte antigen CD20 binding agent | Binding agent | EFO_0000095   | chronic lymphocytic leukemia        | 2 | Completed              | <a href="https://clinicaltrials.gov/search?id=%22NCT00476047%22">https://clinicaltrials.gov/search?id=%22NCT00476047%22</a>   |
| CHEMBL1201604 | TOSITUMOMAB      | Antibody | B-lymphocyte antigen CD20 binding agent | Binding agent | EFO_0000574   | lymphoma                            | 2 | Completed              | <a href="https://clinicaltrials.gov/search?id=%22NCT00107380%22">https://clinicaltrials.gov/search?id=%22NCT00107380%22</a> , <a href="https://clinicaltrials.gov/sea">https://clinicaltrials.gov/sea</a> |
| CHEMBL1201604 | TOSITUMOMAB      | Antibody | B-lymphocyte antigen CD20 binding agent | Binding agent | EFO_1001469   | Mantle cell lymphoma                | 2 | Completed              | <a href="https://clinicaltrials.gov/search?id=%22NCT00992992%22">https://clinicaltrials.gov/search?id=%22NCT00992992%22</a>   |
| CHEMBL1201604 | TOSITUMOMAB      | Antibody | B-lymphocyte antigen CD20 binding agent | Binding agent | EFO_0000096   | neoplasm of mature B-cells          | 1 | Completed              | <a href="https://clinicaltrials.gov/search?id=%22NCT00434629%22">https://clinicaltrials.gov/search?id=%22NCT00434629%22</a>   |
| CHEMBL1201604 | TOSITUMOMAB      | Antibody | B-lymphocyte antigen CD20 binding agent | Binding agent | EFO_0005952   | non-Hodgkins lymphoma               | 1 | Completed              | <a href="https://clinicaltrials.gov/search?id=%22NCT00434629%22">https://clinicaltrials.gov/search?id=%22NCT00434629%22</a> , <a href="https://clinicaltrials.gov/sea">https://clinicaltrials.gov/sea</a> |
| CHEMBL1201604 | TOSITUMOMAB      | Antibody | B-lymphocyte antigen CD20 binding agent | Binding agent | MONDO_0018906 | follicular lymphoma                 | 1 | Completed              | <a href="https://clinicaltrials.gov/search?id=%22NCT00315731%22">https://clinicaltrials.gov/search?id=%22NCT00315731%22</a>   |
| CHEMBL3833304 | TOSITUMOMAB 131I | Antibody | B-lymphocyte antigen CD20 binding agent | Binding agent | EFO_0000574   | lymphoma                            | 2 | Completed              | <a href="https://clinicaltrials.gov/search?id=%22NCT00006695%22">https://clinicaltrials.gov/search?id=%22NCT00006695%22</a> , <a href="https://clinicaltrials.gov/sea">https://clinicaltrials.gov/sea</a> |
| CHEMBL3833304 | TOSITUMOMAB 131I | Antibody | B-lymphocyte antigen CD20 binding agent | Binding agent | EFO_0001378   | multiple myeloma                    | 2 | Active, not recruiting | <a href="https://clinicaltrials.gov/search?id=%22NCT00135200%22">https://clinicaltrials.gov/search?id=%22NCT00135200%22</a>   |
| CHEMBL3833304 | TOSITUMOMAB 131I | Antibody | B-lymphocyte antigen CD20 binding agent | Binding agent | EFO_0003032   | anaplastic large cell lymphoma      | 2 | Completed              | <a href="https://clinicaltrials.gov/search?id=%22NCT00073918%22">https://clinicaltrials.gov/search?id=%22NCT00073918%22</a>   |
| CHEMBL3833304 | TOSITUMOMAB 131I | Antibody | B-lymphocyte antigen CD20 binding agent | Binding agent | EFO_0000095   | chronic lymphocytic leukemia        | 1 | Unknown status         | <a href="https://clinicaltrials.gov/search?id=%22NCT00022880%22">https://clinicaltrials.gov/search?id=%22NCT00022880%22</a>   |
| CHEMBL3833304 | TOSITUMOMAB 131I | Antibody | B-lymphocyte antigen CD20 binding agent | Binding agent | EFO_0000096   | neoplasm of mature B-cells          | 1 | Completed              | <a href="https://clinicaltrials.gov/search?id=%22NCT00434629%22">https://clinicaltrials.gov/search?id=%22NCT00434629%22</a>   |
| CHEMBL3833304 | TOSITUMOMAB 131I | Antibody | B-lymphocyte antigen CD20 binding agent | Binding agent | EFO_0000183   | Hodgkins lymphoma                   | 1 | Completed              | <a href="https://clinicaltrials.gov/search?id=%22NCT00484874%22">https://clinicaltrials.gov/search?id=%22NCT00484874%22</a>   |

|               |                  |          |   |               |               |  |                          |   |
|---------------|------------------|----------|---|---------------|---------------|--|--------------------------|---|
| CHEMBL3833304 | TOSITUMOMAB 131I | Antibody | B-lymphocyte antigen CD20 binding agent | Binding agent | EFO_0000309   | Burkitts lymphoma                      | 1 Completed              | <a href="https://clinicaltrials.gov/search?id=%22NCT00110071%22">https://clinicaltrials.gov/search?id=%22NCT00110071%22</a>   |
| CHEMBL3833304 | TOSITUMOMAB 131I | Antibody | B-lymphocyte antigen CD20 binding agent | Binding agent | EFO_0000403   | diffuse large B-cell lymphoma          | 1 Completed              | <a href="https://clinicaltrials.gov/search?id=%22NCT00110071%22">https://clinicaltrials.gov/search?id=%22NCT00110071%22</a>   |
| CHEMBL3833304 | TOSITUMOMAB 131I | Antibody | B-lymphocyte antigen CD20 binding agent | Binding agent | EFO_0005952   | non-Hodgkins lymphoma                  | 1 Completed              | <a href="https://clinicaltrials.gov/search?id=%22NCT00434629%22">https://clinicaltrials.gov/search?id=%22NCT00434629%22</a> , <a href="https://clinicaltrials.gov/sea">https://clinicaltrials.gov/sea</a> |
| CHEMBL3833304 | TOSITUMOMAB 131I | Antibody | B-lymphocyte antigen CD20 binding agent | Binding agent | EFO_0009441   | Waldenstrom macroglobulinemia          | 1 Completed              | <a href="https://clinicaltrials.gov/search?id=%22NCT00110071%22">https://clinicaltrials.gov/search?id=%22NCT00110071%22</a>   |
| CHEMBL3833304 | TOSITUMOMAB 131I | Antibody | B-lymphocyte antigen CD20 binding agent | Binding agent | EFO_1000550   | Splenic Marginal Zone Lymphoma         | 1 Completed              | <a href="https://clinicaltrials.gov/search?id=%22NCT00110071%22">https://clinicaltrials.gov/search?id=%22NCT00110071%22</a>   |
| CHEMBL3833304 | TOSITUMOMAB 131I | Antibody | B-lymphocyte antigen CD20 binding agent | Binding agent | EFO_1001469   | Mantle cell lymphoma                   | 1 Completed              | <a href="https://clinicaltrials.gov/search?id=%22NCT00110071%22">https://clinicaltrials.gov/search?id=%22NCT00110071%22</a>   |
| CHEMBL3833304 | TOSITUMOMAB 131I | Antibody | B-lymphocyte antigen CD20 binding agent | Binding agent | MONDO_0000873 | lymphoblastic lymphoma                 | 1 Completed              | <a href="https://clinicaltrials.gov/search?id=%22NCT00110071%22">https://clinicaltrials.gov/search?id=%22NCT00110071%22</a>   |
| CHEMBL3833304 | TOSITUMOMAB 131I | Antibody | B-lymphocyte antigen CD20 binding agent | Binding agent | MONDO_0018906 | follicular lymphoma                    | 1 Completed              | <a href="https://clinicaltrials.gov/search?id=%22NCT00110071%22">https://clinicaltrials.gov/search?id=%22NCT00110071%22</a> , <a href="https://clinicaltrials.gov/sea">https://clinicaltrials.gov/sea</a> |
| CHEMBL3833304 | TOSITUMOMAB 131I | Antibody | B-lymphocyte antigen CD20 binding agent | Binding agent | MONDO_0019465 | nodal marginal zone B-cell lymphoma    | 1 Completed              | <a href="https://clinicaltrials.gov/search?id=%22NCT00110071%22">https://clinicaltrials.gov/search?id=%22NCT00110071%22</a>   |
| CHEMBL1743083 | TREGALIZUMAB     | Antibody | T-cell surface antigen CD4 agonist      | Agonist       | EFO_0000685   | rheumatoid arthritis                   | 2 Completed              | <a href="https://clinicaltrials.gov/search?id=%22NCT01481493%22">https://clinicaltrials.gov/search?id=%22NCT01481493%22</a>   |
| CHEMBL1743083 | TREGALIZUMAB     | Antibody | T-cell surface antigen CD4 agonist      | Agonist       | EFO_1001494   | psoriasis vulgaris                     | 2 Completed              | <a href="https://clinicaltrials.gov/search?id=%22NCT01072383%22">https://clinicaltrials.gov/search?id=%22NCT01072383%22</a>   |
| CHEMBL1743083 | TREGALIZUMAB     | Antibody | T-cell surface antigen CD4 agonist      | Agonist       | MONDO_0004784 | allergic asthma                        | 2 Recruiting             | <a href="https://clinicaltrials.gov/search?id=%22NCT04673591%22">https://clinicaltrials.gov/search?id=%22NCT04673591%22</a>   |
| CHEMBL4297845 | TRU-015          | Unknown  | B-lymphocyte antigen CD20 binding agent | Binding agent | EFO_0000685   | rheumatoid arthritis                   | 2 Terminated             | <a href="https://clinicaltrials.gov/search?id=%22NCT00634933%22">https://clinicaltrials.gov/search?id=%22NCT00634933%22</a>   |
| CHEMBL4297845 | TRU-015          | Unknown  | B-lymphocyte antigen CD20 binding agent | Binding agent | EFO_0000574   | lymphoma                               | 1 Terminated             | <a href="https://clinicaltrials.gov/search?id=%22NCT00521638%22">https://clinicaltrials.gov/search?id=%22NCT00521638%22</a>   |
| CHEMBL4297845 | TRU-015          | Unknown  | B-lymphocyte antigen CD20 binding agent | Binding agent | EFO_0002690   | systemic lupus erythematosus           | 1 Terminated             | <a href="https://clinicaltrials.gov/search?id=%22NCT00479622%22">https://clinicaltrials.gov/search?id=%22NCT00479622%22</a>   |
| CHEMBL2108354 | UBLITUXIMAB      | Antibody | B-lymphocyte antigen CD20 binding agent | Binding agent | EFO_0000403   | diffuse large B-cell lymphoma          | 2 Recruiting             | <a href="https://clinicaltrials.gov/search?id=%22NCT02793583%22">https://clinicaltrials.gov/search?id=%22NCT02793583%22</a>   |
| CHEMBL2108354 | UBLITUXIMAB      | Antibody | B-lymphocyte antigen CD20 binding agent | Binding agent | EFO_0003885   | multiple sclerosis                     | 2 Completed              | <a href="https://clinicaltrials.gov/search?id=%22NCT02738775%22">https://clinicaltrials.gov/search?id=%22NCT02738775%22</a>   |
| CHEMBL2108354 | UBLITUXIMAB      | Antibody | B-lymphocyte antigen CD20 binding agent | Binding agent | EFO_0003929   | relapsing-remitting multiple sclerosis | 2 Active, not recruiting | <a href="https://clinicaltrials.gov/search?id=%22NCT03381170%22">https://clinicaltrials.gov/search?id=%22NCT03381170%22</a>   |
| CHEMBL2108354 | UBLITUXIMAB      | Antibody | B-lymphocyte antigen CD20 binding agent | Binding agent | MONDO_0018906 | follicular lymphoma                    | 2 Recruiting             | <a href="https://clinicaltrials.gov/search?id=%22NCT03828448%22">https://clinicaltrials.gov/search?id=%22NCT03828448%22</a> , <a href="https://clinicaltrials.gov/sea">https://clinicaltrials.gov/sea</a> |
| CHEMBL2108354 | UBLITUXIMAB      | Antibody | B-lymphocyte antigen CD20 binding agent | Binding agent | EFO_0000095   | chronic lymphocytic leukemia           | 1 Recruiting             | <a href="https://clinicaltrials.gov/search?id=%22NCT03671590%22">https://clinicaltrials.gov/search?id=%22NCT03671590%22</a> , <a href="https://clinicaltrials.gov/sea">https://clinicaltrials.gov/sea</a> |
| CHEMBL2108354 | UBLITUXIMAB      | Antibody | B-lymphocyte antigen CD20 binding agent | Binding agent | EFO_0000096   | neoplasm of mature B-cells             | 1 Recruiting             | <a href="https://clinicaltrials.gov/search?id=%22NCT03804996%22">https://clinicaltrials.gov/search?id=%22NCT03804996%22</a>   |
| CHEMBL2108354 | UBLITUXIMAB      | Antibody | B-lymphocyte antigen CD20 binding agent | Binding agent | EFO_0004256   | neuromyelitis optica                   | 1 Completed              | <a href="https://clinicaltrials.gov/search?id=%22NCT02276963%22">https://clinicaltrials.gov/search?id=%22NCT02276963%22</a>   |
| CHEMBL2108354 | UBLITUXIMAB      | Antibody | B-lymphocyte antigen CD20 binding agent | Binding agent | EFO_0009441   | Waldenstrom macroglobulinemia          | 1 Completed              | <a href="https://clinicaltrials.gov/search?id=%22NCT01744912%22">https://clinicaltrials.gov/search?id=%22NCT01744912%22</a>   |
| CHEMBL2108354 | UBLITUXIMAB      | Antibody | B-lymphocyte antigen CD20 binding agent | Binding agent | EFO_1001469   | Mantle cell lymphoma                   | 1 Completed              | <a href="https://clinicaltrials.gov/search?id=%22NCT01744912%22">https://clinicaltrials.gov/search?id=%22NCT01744912%22</a>   |
| CHEMBL3137347 | VARLILUMAB       | Antibody | CD27 antigen agonist                    | Agonist       | EFO_0000519   | glioblastoma multiforme                | 2 Recruiting             | <a href="https://clinicaltrials.gov/search?id=%22NCT03688178%22">https://clinicaltrials.gov/search?id=%22NCT03688178%22</a>   |
| CHEMBL3137347 | VARLILUMAB       | Antibody | CD27 antigen agonist                    | Agonist       | EFO_1001961   | intrahepatic cholangiocarcinoma        | 2 Not yet recruiting     | <a href="https://clinicaltrials.gov/search?id=%22NCT04941287%22">https://clinicaltrials.gov/search?id=%22NCT04941287%22</a>   |
| CHEMBL3137347 | VARLILUMAB       | Antibody | CD27 antigen agonist                    | Agonist       | EFO_0000272   | astrocytoma                            | 1 Active, not recruiting | <a href="https://clinicaltrials.gov/search?id=%22NCT02924038%22">https://clinicaltrials.gov/search?id=%22NCT02924038%22</a>   |
| CHEMBL3137347 | VARLILUMAB       | Antibody | CD27 antigen agonist                    | Agonist       | EFO_0000574   | lymphoma                               | 1 Active, not recruiting | <a href="https://clinicaltrials.gov/search?id=%22NCT03307746%22">https://clinicaltrials.gov/search?id=%22NCT03307746%22</a>   |
| CHEMBL3137347 | VARLILUMAB       | Antibody | CD27 antigen agonist                    | Agonist       | EFO_0000630   | oligoastrocytoma                       | 1 Active, not recruiting | <a href="https://clinicaltrials.gov/search?id=%22NCT02924038%22">https://clinicaltrials.gov/search?id=%22NCT02924038%22</a>   |
| CHEMBL3137347 | VARLILUMAB       | Antibody | CD27 antigen agonist                    | Agonist       | EFO_0000632   | oligodendroglioma                      | 1 Active, not recruiting | <a href="https://clinicaltrials.gov/search?id=%22NCT02924038%22">https://clinicaltrials.gov/search?id=%22NCT02924038%22</a>   |
| CHEMBL3137347 | VARLILUMAB       | Antibody | CD27 antigen agonist                    | Agonist       | EFO_0000681   | renal cell carcinoma                   | 1 Terminated             | <a href="https://clinicaltrials.gov/search?id=%22NCT02386111%22">https://clinicaltrials.gov/search?id=%22NCT02386111%22</a>   |
| CHEMBL3137347 | VARLILUMAB       | Antibody | CD27 antigen agonist                    | Agonist       | EFO_0000756   | melanoma                               | 1 Terminated             | <a href="https://clinicaltrials.gov/search?id=%22NCT02413827%22">https://clinicaltrials.gov/search?id=%22NCT02413827%22</a>   |



|               |                                  |          |   |               |               |                                       |                          |   |
|---------------|----------------------------------|----------|---|---------------|---------------|---------------------------------------|--------------------------|---|
| CHEMBL3137347 | VARLILUMAB                       | Antibody | CD27 antigen agonist                    | Agonist       | EFO_0003060   | non-small cell lung carcinoma         | 1 Recruiting             | <a href="https://clinicaltrials.gov/search?id=%22NCT04081688%22">https://clinicaltrials.gov/search?id=%22NCT04081688%22</a>   |
| CHEMBL3137347 | VARLILUMAB                       | Antibody | CD27 antigen agonist                    | Agonist       | EFO_0003863   | urogenital neoplasm                   | 1 Terminated             | <a href="https://clinicaltrials.gov/search?id=%22NCT02386111%22">https://clinicaltrials.gov/search?id=%22NCT02386111%22</a>   |
| CHEMBL1743088 | VELTUZUMAB                       | Antibody | B-lymphocyte antigen CD20 binding agent | Binding agent | EFO_0000685   | rheumatoid arthritis                  | 2 Terminated             | <a href="https://clinicaltrials.gov/search?id=%22NCT01390545%22">https://clinicaltrials.gov/search?id=%22NCT01390545%22</a>   |
| CHEMBL1743088 | VELTUZUMAB                       | Antibody | B-lymphocyte antigen CD20 binding agent | Binding agent | EFO_0000095   | chronic lymphocytic leukemia          | 1 Completed              | <a href="https://clinicaltrials.gov/search?id=%22NCT00546793%22">https://clinicaltrials.gov/search?id=%22NCT00546793%22</a>   |
| CHEMBL1743088 | VELTUZUMAB                       | Antibody | B-lymphocyte antigen CD20 binding agent | Binding agent | EFO_0000220   | acute lymphoblastic leukemia          | 1 Unknown status         | <a href="https://clinicaltrials.gov/search?id=%22NCT01279707%22">https://clinicaltrials.gov/search?id=%22NCT01279707%22</a>   |
| CHEMBL1743088 | VELTUZUMAB                       | Antibody | B-lymphocyte antigen CD20 binding agent | Binding agent | EFO_0000403   | diffuse large B-cell lymphoma         | 1 Withdrawn              | <a href="https://clinicaltrials.gov/search?id=%22NCT01101581%22">https://clinicaltrials.gov/search?id=%22NCT01101581%22</a>   |
| CHEMBL1743088 | VELTUZUMAB                       | Antibody | B-lymphocyte antigen CD20 binding agent | Binding agent | EFO_0000574   | lymphoma                              | 1 Completed              | <a href="https://clinicaltrials.gov/search?id=%22NCT00989586%22">https://clinicaltrials.gov/search?id=%22NCT00989586%22</a>   |
| CHEMBL1743088 | VELTUZUMAB                       | Antibody | B-lymphocyte antigen CD20 binding agent | Binding agent | EFO_0005952   | non-Hodgkins lymphoma                 | 1 Completed              | <a href="https://clinicaltrials.gov/search?id=%22NCT00596804%22">https://clinicaltrials.gov/search?id=%22NCT00596804%22</a> , <a href="https://clinicaltrials.gov/sea">https://clinicaltrials.gov/sea</a> |
| CHEMBL1743088 | VELTUZUMAB                       | Antibody | B-lymphocyte antigen CD20 binding agent | Binding agent | EFO_0007160   | autoimmune thrombocytopenic purpu     | 1 Terminated             | <a href="https://clinicaltrials.gov/search?id=%22NCT00547066%22">https://clinicaltrials.gov/search?id=%22NCT00547066%22</a>   |
| CHEMBL1743088 | VELTUZUMAB                       | Antibody | B-lymphocyte antigen CD20 binding agent | Binding agent | MONDO_0000432 | lymphoplasmacytic lymphoma            | 1 Completed              | <a href="https://clinicaltrials.gov/search?id=%22NCT00546793%22">https://clinicaltrials.gov/search?id=%22NCT00546793%22</a>   |
| CHEMBL1743088 | VELTUZUMAB                       | Antibody | B-lymphocyte antigen CD20 binding agent | Binding agent | MONDO_0018906 | follicular lymphoma                   | 1 Terminated             | <a href="https://clinicaltrials.gov/search?id=%22NCT01147393%22">https://clinicaltrials.gov/search?id=%22NCT01147393%22</a>   |
| CHEMBL2108667 | YTTRIUM Y 90 IBRITUMOMAB TIUXETA | Antibody | B-lymphocyte antigen CD20 binding agent | Binding agent | EFO_0000565   | leukemia                              | 2 Active, not recruiting | <a href="https://clinicaltrials.gov/search?id=%22NCT00577278%22">https://clinicaltrials.gov/search?id=%22NCT00577278%22</a>   |
| CHEMBL2108667 | YTTRIUM Y 90 IBRITUMOMAB TIUXETA | Antibody | B-lymphocyte antigen CD20 binding agent | Binding agent | EFO_0003032   | anaplastic large cell lymphoma        | 2 Withdrawn              | <a href="https://clinicaltrials.gov/search?id=%22NCT00310128%22">https://clinicaltrials.gov/search?id=%22NCT00310128%22</a>   |
| CHEMBL2108667 | YTTRIUM Y 90 IBRITUMOMAB TIUXETA | Antibody | B-lymphocyte antigen CD20 binding agent | Binding agent | MONDO_0013730 | graft versus host disease             | 2 Active, not recruiting | <a href="https://clinicaltrials.gov/search?id=%22NCT00577278%22">https://clinicaltrials.gov/search?id=%22NCT00577278%22</a>   |
| CHEMBL2108667 | YTTRIUM Y 90 IBRITUMOMAB TIUXETA | Antibody | B-lymphocyte antigen CD20 binding agent | Binding agent | MONDO_0044887 | central nervous system non-hodgkin ly | 2 Terminated             | <a href="https://clinicaltrials.gov/search?id=%22NCT01973062%22">https://clinicaltrials.gov/search?id=%22NCT01973062%22</a>   |
| CHEMBL2108667 | YTTRIUM Y 90 IBRITUMOMAB TIUXETA | Antibody | B-lymphocyte antigen CD20 binding agent | Binding agent | EFO_0000096   | neoplasm of mature B-cells            | 1 Completed              | <a href="https://clinicaltrials.gov/search?id=%22NCT00761384%22">https://clinicaltrials.gov/search?id=%22NCT00761384%22</a>   |
| CHEMBL2108667 | YTTRIUM Y 90 IBRITUMOMAB TIUXETA | Antibody | B-lymphocyte antigen CD20 binding agent | Binding agent | EFO_0000183   | Hodgkins lymphoma                     | 1 Terminated             | <a href="https://clinicaltrials.gov/search?id=%22NCT00036855%22">https://clinicaltrials.gov/search?id=%22NCT00036855%22</a>   |
| CHEMBL2108667 | YTTRIUM Y 90 IBRITUMOMAB TIUXETA | Antibody | B-lymphocyte antigen CD20 binding agent | Binding agent | EFO_0000191   | MALT lymphoma                         | 1 Terminated             | <a href="https://clinicaltrials.gov/search?id=%22NCT00012298%22">https://clinicaltrials.gov/search?id=%22NCT00012298%22</a>   |
| CHEMBL2108667 | YTTRIUM Y 90 IBRITUMOMAB TIUXETA | Antibody | B-lymphocyte antigen CD20 binding agent | Binding agent | EFO_0000309   | Burkitts lymphoma                     | 1 Completed              | <a href="https://clinicaltrials.gov/search?id=%22NCT00064246%22">https://clinicaltrials.gov/search?id=%22NCT00064246%22</a>   |
| CHEMBL2108667 | YTTRIUM Y 90 IBRITUMOMAB TIUXETA | Antibody | B-lymphocyte antigen CD20 binding agent | Binding agent | EFO_0000574   | lymphoma                              | 1 Completed              | <a href="https://clinicaltrials.gov/search?id=%22NCT00058292%22">https://clinicaltrials.gov/search?id=%22NCT00058292%22</a> , <a href="https://clinicaltrials.gov/sea">https://clinicaltrials.gov/sea</a> |
| CHEMBL2108667 | YTTRIUM Y 90 IBRITUMOMAB TIUXETA | Antibody | B-lymphocyte antigen CD20 binding agent | Binding agent | EFO_0001378   | multiple myeloma                      | 1 Completed              | <a href="https://clinicaltrials.gov/search?id=%22NCT00477815%22">https://clinicaltrials.gov/search?id=%22NCT00477815%22</a>   |
| CHEMBL2108667 | YTTRIUM Y 90 IBRITUMOMAB TIUXETA | Antibody | B-lymphocyte antigen CD20 binding agent | Binding agent | EFO_0005952   | non-Hodgkins lymphoma                 | 1 Unknown status         | <a href="https://clinicaltrials.gov/search?id=%22NCT00807196%22">https://clinicaltrials.gov/search?id=%22NCT00807196%22</a>   |
| CHEMBL2108667 | YTTRIUM Y 90 IBRITUMOMAB TIUXETA | Antibody | B-lymphocyte antigen CD20 binding agent | Binding agent | EFO_1000550   | Splenic Marginal Zone Lymphoma        | 1 Terminated             | <a href="https://clinicaltrials.gov/search?id=%22NCT00012298%22">https://clinicaltrials.gov/search?id=%22NCT00012298%22</a>   |
| CHEMBL2108667 | YTTRIUM Y 90 IBRITUMOMAB TIUXETA | Antibody | B-lymphocyte antigen CD20 binding agent | Binding agent | EFO_1001365   | Lymphoma, AIDS-Related                | 1 Terminated             | <a href="https://clinicaltrials.gov/search?id=%22NCT00036855%22">https://clinicaltrials.gov/search?id=%22NCT00036855%22</a>   |
| CHEMBL2108667 | YTTRIUM Y 90 IBRITUMOMAB TIUXETA | Antibody | B-lymphocyte antigen CD20 binding agent | Binding agent | MONDO_0000873 | lymphoblastic lymphoma                | 1 Terminated             | <a href="https://clinicaltrials.gov/search?id=%22NCT00036855%22">https://clinicaltrials.gov/search?id=%22NCT00036855%22</a>   |
| CHEMBL2108667 | YTTRIUM Y 90 IBRITUMOMAB TIUXETA | Antibody | B-lymphocyte antigen CD20 binding agent | Binding agent | MONDO_0019088 | post-transplant lymphoproliferative d | 1 Completed              | <a href="https://clinicaltrials.gov/search?id=%22NCT00064246%22">https://clinicaltrials.gov/search?id=%22NCT00064246%22</a>   |
| CHEMBL2108667 | YTTRIUM Y 90 IBRITUMOMAB TIUXETA | Antibody | B-lymphocyte antigen CD20 binding agent | Binding agent | MONDO_0019465 | nodal marginal zone B-cell lymphoma   | 1 Terminated             | <a href="https://clinicaltrials.gov/search?id=%22NCT00012298%22">https://clinicaltrials.gov/search?id=%22NCT00012298%22</a>   |
| CHEMBL2108667 | YTTRIUM Y 90 IBRITUMOMAB TIUXETA | Antibody | B-lymphocyte antigen CD20 binding agent | Binding agent | EFO_0000095   | chronic lymphocytic leukemia          | 0 Completed              | <a href="https://clinicaltrials.gov/search?id=%22NCT00017381%22">https://clinicaltrials.gov/search?id=%22NCT00017381%22</a>   |
| CHEMBL2108667 | YTTRIUM Y 90 IBRITUMOMAB TIUXETA | Antibody | B-lymphocyte antigen CD20 binding agent | Binding agent | EFO_0000403   | diffuse large B-cell lymphoma         | 0 Completed              | <a href="https://clinicaltrials.gov/search?id=%22NCT00017381%22">https://clinicaltrials.gov/search?id=%22NCT00017381%22</a>   |
| CHEMBL2108667 | YTTRIUM Y 90 IBRITUMOMAB TIUXETA | Antibody | B-lymphocyte antigen CD20 binding agent | Binding agent | EFO_0009441   | Waldenstrom macroglobulinemia         | 0 Completed              | <a href="https://clinicaltrials.gov/search?id=%22NCT00017381%22">https://clinicaltrials.gov/search?id=%22NCT00017381%22</a>   |
| CHEMBL2108667 | YTTRIUM Y 90 IBRITUMOMAB TIUXETA | Antibody | B-lymphocyte antigen CD20 binding agent | Binding agent | EFO_1000630   | marginal zone B-cell lymphoma         | 0 Completed              | <a href="https://clinicaltrials.gov/search?id=%22NCT00017381%22">https://clinicaltrials.gov/search?id=%22NCT00017381%22</a>   |
| CHEMBL2108667 | YTTRIUM Y 90 IBRITUMOMAB TIUXETA | Antibody | B-lymphocyte antigen CD20 binding agent | Binding agent | EFO_1001469   | Mantle cell lymphoma                  | 0 Completed              | <a href="https://clinicaltrials.gov/search?id=%22NCT00017381%22">https://clinicaltrials.gov/search?id=%22NCT00017381%22</a>   |

CHEMBL2108667

YTTRIUM Y 90 IBRITUMOMAB TIUXETA Antibody B-lymphocyte antigen CD20 binding agent

Binding agent

MONDO\_0018906

follicular lymphoma

0 Completed

<https://clinicaltrials.gov/search?id=%22NCT00017381%22>

## **FinnGen Full Name**

Aarno Palotie

Mark Daly

Bridget Riley-Gills

Howard Jacob

Dirk Paul

Athena Matakidou

Adam Platt

Heiko Runz

Sally John

George Okafo

Nathan Lawless

Robert Plenge

Joseph Maranville

Mark McCarthy

Julie Hunkapiller

Margaret G. Ehm

Kirsi Auro

Simonne Longerich

Caroline Fox

Anders Mälarstig

Katherine Klinger

Deepak Rajpal

Eric Green

Robert Graham

Robert Yang

Chris O'Donnell

Tomi P. Mäkelä

Jaakko Kaprio

Petri Virolainen

Antti Hakanen

## **Affiliation**

Institute for Molecular Medicine Finland (FIMM), HiLIFE, University of Helsinki, Helsinki,

Institute for Molecular Medicine Finland (FIMM), HiLIFE, University of Helsinki, Helsinki,

Abbvie, Chicago, IL, United States

Abbvie, Chicago, IL, United States

Astra Zeneca, Cambridge, United Kingdom

Astra Zeneca, Cambridge, United Kingdom

Astra Zeneca, Cambridge, United Kingdom

Biogen, Cambridge, MA, United States

Biogen, Cambridge, MA, United States

Boehringer Ingelheim, Ingelheim am Rhein, Germany

Boehringer Ingelheim, Ingelheim am Rhein, Germany

Bristol Myers Squibb, New York, NY, United States

Bristol Myers Squibb, New York, NY, United States

Genentech, San Francisco, CA, United States

Genentech, San Francisco, CA, United States

GlaxoSmithKline, Collegeville, PA, United States

GlaxoSmithKline, Espoo, Finland

Merck, Kenilworth, NJ, United States

Merck, Kenilworth, NJ, United States

Pfizer, New York, NY, United States

Translational Sciences, Sanofi R&D, Framingham, MA, USA

Translational Sciences, Sanofi R&D, Framingham, MA, USA

Maze Therapeutics, San Francisco, CA, United States

Maze Therapeutics, San Francisco, CA, United States

Janssen Biotech, Beerse, Belgium

Novartis Institutes for BioMedical Research, Cambridge, MA, United States

HiLIFE, University of Helsinki, Finland, Finland

Institute for Molecular Medicine Finland (FIMM), HiLIFE, University of Helsinki, Helsinki, Finland

Auria Biobank / University of Turku / Hospital District of Southwest Finland, Turku, Finland

Auria Biobank / University of Turku / Hospital District of Southwest Finland, Turku, Finland

## **E-mail**

aarno.palotie@helsinki.fi

mark.daly@helsinki.fi

bridget.rileygillis@abbvie.com

howard.jacob@abbvie.com

dirk.paul@astrazeneca.com

athena.x.matakidou@gsk.com

adam.platt@astrazeneca.com

heiko.runz@biogen.com

sally.john@biogen.com

george.okafo@boehringer-ingenelheim.com

nathan.lawless@boehringer-ingenelheim.com

robert.plenge@bms.com

joseph.maranville@bms.com

mccarthy.mark@gene.com

hunkapiller.julie@gene.com

meg.g.ehm@gsk.com

kirsi.m.auro@gsk.com

simonne.longerich@merck.com

caroline.fox@merck.com

anders.malarstig@pfizer.com

katherine.klinger@sanofi.com

deepak.rajpal@sanofi.com

egreen@mazetx.com

rgraham@mazetx.com

ryang31@its.jnj.com

chris.odonnell@novartis.com

tomi.makela@helsinki.fi

jaakko.kaprio@helsinki.fi

petri.virolainen@tyks.fi

antti.hakanen@tyks.fi

## **Role 1**

**Steering Committee**

**Steering Committee**

**Steering Committee**

**Steering Committee**

**Steering Committee**

**Steering Committee**

**Steering Committee**

**Steering Committee**

**Steering Committee**

**Steering Committee**

**Steering Committee**

**Steering Committee**

**Steering Committee**

**Steering Committee**

**Steering Committee**

**Steering Committee**

**Steering Committee**

**Steering Committee**

**Steering Committee**

**Steering Committee**

**Steering Committee**

**Steering Committee**

**Steering Committee**

**Steering Committee**

**Steering Committee**

**Steering Committee**

**Steering Committee**

**Steering Committee**

**Steering Committee**

**Steering Committee**

## **Role 2**

**Steering Committee**

**Steering Committee**

**Pharmaceutical companies**

**Pharmaceutical companies**

**Pharmaceutical companies**

**Pharmaceutical companies**

**Pharmaceutical companies**

**Pharmaceutical companies**

**Pharmaceutical companies**

**Pharmaceutical companies**

**Pharmaceutical companies**

**Pharmaceutical companies**

**Pharmaceutical companies**

**Pharmaceutical companies**

**Pharmaceutical companies**

**Pharmaceutical companies**

**Pharmaceutical companies**

**Pharmaceutical companies**

**Pharmaceutical companies**

**Pharmaceutical companies**

**Pharmaceutical companies**

**Pharmaceutical companies**

**Pharmaceutical companies**

**Pharmaceutical companies**

**Pharmaceutical companies**

**University of Helsinki & Biobanks**

**University of Helsinki & Biobanks**

**University of Helsinki & Biobanks**

**University of Helsinki & Biobanks**

**University of Helsinki & Biobanks**

|                         |   |   |                      |                                   |
|-------------------------|---|---|----------------------|-----------------------------------|
| Terhi Kilpi             | THL Biobank / Finnish Institute for Health and Welfare (THL), Helsinki, Finland                                 | terhi.kilpi@thl.fi                          | Steering Committee   | University of Helsinki & Biobanks |
| Markus Perola           | THL Biobank / Finnish Institute for Health and Welfare (THL), Helsinki, Finland                                 | markus.perola@thl.fi                        | Steering Committee   | University of Helsinki & Biobanks |
| Jukka Partanen          | Finnish Red Cross Blood Service / Finnish Hematology Registry and Clinical Biobank, Helsinki, Finland           | jukka.partanen@veripalvelu.fi               | Steering Committee   | University of Helsinki & Biobanks |
| Anne Pitkäranta         | Helsinki Biobank / Helsinki University and Hospital District of Helsinki and Uusimaa, Helsinki                  | anne.pitkaranta@hus.fi                      | Steering Committee   | University of Helsinki & Biobanks |
| Juhani Junttila         | Northern Finland Biobank Borealis / University of Oulu / Northern Ostrobothnia Hospital District, Oulu, Finland | juhani.junttila@ppshp.fi                    | Steering Committee   | University of Helsinki & Biobanks |
| Raisa Serpi             | Northern Finland Biobank Borealis / University of Oulu / Northern Ostrobothnia Hospital District, Oulu, Finland | rais.serpi@ppshp.fi                         | Steering Committee   | University of Helsinki & Biobanks |
| Tarja Laitinen          | Finnish Clinical Biobank Tampere / University of Tampere / Pirkanmaa Hospital District, Tampere, Finland        | tarja.laitinen@pshp.fi                      | Steering Committee   | University of Helsinki & Biobanks |
| Veli-Matti Kosma        | Biobank of Eastern Finland / University of Eastern Finland / Northern Savo Hospital District, Kuopio, Finland   | veli-matti.kosma@uef.fi                     | Steering Committee   | University of Helsinki & Biobanks |
| Jari Laukkanen          | Central Finland Biobank / University of Jyväskylä / Central Finland Health Care District, Jyväskylä, Finland    | jari.laukkanen@ksshp.fi                     | Steering Committee   | University of Helsinki & Biobanks |
| Marco Hautalahti        | FINBB - Finnish biobank cooperative   | marco.hautalahti@finbb.fi                   | Steering Committee   | University of Helsinki & Biobanks |
| Outi Tuovila            | Business Finland, Helsinki, Finland   | outi.tuovila@businessfinland.fi             | Steering Committee   | Other Experts/ Non-Voting Members |
| Raimo Pakkanen          | Business Finland, Helsinki, Finland   | raimo.pakkanen@businessfinland.fi           | Steering Committee   | Other Experts/ Non-Voting Members |
| Jeffrey Waring          | Abbvie, Chicago, IL, United States  | jeff.waring@abbvie.com                      | Scientific Committee | Pharmaceutical companies          |
| Bridget Riley-Gillis    | Abbvie, Chicago, IL, United States  | bridget.rileygillis@abbvie.com              | Scientific Committee | Pharmaceutical companies          |
| Fedik Rahimov           | Abbvie, Chicago, IL, United States  | fedik.rahimov@abbvie.com                    | Scientific Committee | Pharmaceutical companies          |
| Ioanna Tachmazidou      | Astra Zeneca, Cambridge, United Kingdom   | ioanna.tachmazidou@astrazeneca.com          | Scientific Committee | Pharmaceutical companies          |
| Chia-Yen Chen           | Biogen, Cambridge, MA, United States  | chiayen.chen@biogen.com                     | Scientific Committee | Pharmaceutical companies          |
| Heiko Runz              | Biogen, Cambridge, MA, United States  | heiko.runz@biogen.com                       | Scientific Committee | Pharmaceutical companies          |
| Zhihao Ding             | Boehringer Ingelheim, Ingelheim am Rhein, Germany   | zhihao.ding@boehringer-ingenelheim.com      | Scientific Committee | Pharmaceutical companies          |
| Marc Jung               | Boehringer Ingelheim, Ingelheim am Rhein, Germany   | marc_oliver.jung@boehringer-ingenelheim.com | Scientific Committee | Pharmaceutical companies          |
| Shameek Biswas          | Bristol Myers Squibb, New York, NY, United States   | Shameek.Biswas@bms.com                      | Scientific Committee | Pharmaceutical companies          |
| Rion Pendergrass        | Genentech, San Francisco, CA, United States   | penders2@gene.com                           | Scientific Committee | Pharmaceutical companies          |
| Julie Hunkapiller       | Genentech, San Francisco, CA, United States   | hunkapiller.julie@gene.com                  | Scientific Committee | Pharmaceutical companies          |
| Margaret G. Ehm         | GlaxoSmithKline, Collegeville, PA, United States  | meg.g.ehm@gsk.com                           | Scientific Committee | Pharmaceutical companies          |
| David Pulford           | GlaxoSmithKline, Stevenage, United Kingdom  | david.x.pulford@gsk.com                     | Scientific Committee | Pharmaceutical companies          |
| Neha Raghavan           | Merck, Kenilworth, NJ, United States  | neha.raghavan@merck.com                     | Scientific Committee | Pharmaceutical companies          |
| Adriana Huertas-Vazquez | Merck, Kenilworth, NJ, United States  | adriana.huertas.vazquez@merck.com           | Scientific Committee | Pharmaceutical companies          |
| Jae-Hoon Sul            | Merck, Kenilworth, NJ, United States  | jae.hoon.sul@merck.com                      | Scientific Committee | Pharmaceutical companies          |
| Anders Mälarstig        | Pfizer, New York, NY, United States   | anders.malarstig@pfizer.com                 | Scientific Committee | Pharmaceutical companies          |

|                       |   |                               |                                      |                                   |
|-----------------------|---|-------------------------------|--------------------------------------|-----------------------------------|
| Xinli Hu              | Pfizer, New York, NY, United States   | xinli.hu@pfizer.com           | <a href="#">Scientific Committee</a> | Pharmaceutical companies          |
| Katherine Klinger     | Translational Sciences, Sanofi R&D, Framingham, MA, USA   | katherine.klinger@sanofi.com  | <a href="#">Scientific Committee</a> | Pharmaceutical companies          |
| Robert Graham         | Maze Therapeutics, San Francisco, CA, United States   | rgraham@mazetx.com            | <a href="#">Scientific Committee</a> | Pharmaceutical companies          |
| Eric Green            | Maze Therapeutics, San Francisco, CA, United States   | egreen@mazetx.com             | <a href="#">Scientific Committee</a> | Pharmaceutical companies          |
| Sahar Mozaffari       | Maze Therapeutics, San Francisco, CA, United States   | smozaffari@mazetx.com         | <a href="#">Scientific Committee</a> | Pharmaceutical companies          |
| Dawn Waterworth       | Janssen Research & Development, LLC, Spring House, PA, United States  | dwaterwo@its.jnj.com          | <a href="#">Scientific Committee</a> | Pharmaceutical companies          |
| Nicole Renaud         | Novartis Institutes for BioMedical Research, Cambridge, MA, United States                                       | nicole.renaud@novartis.com    | <a href="#">Scientific Committee</a> | Pharmaceutical companies          |
| Ma'en Obeidat         | Novartis Institutes for BioMedical Research, Cambridge, MA, United States                                       | maen.obeidat@novartis.com     | <a href="#">Scientific Committee</a> | Pharmaceutical companies          |
| Samuli Ripatti        | Institute for Molecular Medicine Finland (FIMM), HiLIFE, University of Helsinki, Helsinki, Finland              | samuli.ripatti@helsinki.fi    | <a href="#">Scientific Committee</a> | University of Helsinki & Biobanks |
| Johanna Schleutker    | Auria Biobank / Univ. of Turku / Hospital District of Southwest Finland, Turku, Finland                         | johanna.schleutker@utu.fi     | <a href="#">Scientific Committee</a> | University of Helsinki & Biobanks |
| Markus Perola         | THL Biobank / Finnish Institute for Health and Welfare (THL), Helsinki, Finland                                 | markus.perola@thl.fi          | <a href="#">Scientific Committee</a> | University of Helsinki & Biobanks |
| Mikko Arvas           | Finnish Red Cross Blood Service / Finnish Hematology Registry and Clinical Biobank, Helsinki, Finland           | mikko.arvas@veripalvelu.fi    | <a href="#">Scientific Committee</a> | University of Helsinki & Biobanks |
| Olli Carpen           | Helsinki Biobank / Helsinki University and Hospital District of Helsinki and Uusimaa, Helsinki                  | olli.carpen@helsinki.fi       | <a href="#">Scientific Committee</a> | University of Helsinki & Biobanks |
| Reetta Hinttala       | Northern Finland Biobank Borealis / University of Oulu / Northern Ostrobothnia Hospital District, Oulu, Finland | reetta.hinttala@oulu.fi       | <a href="#">Scientific Committee</a> | University of Helsinki & Biobanks |
| Johannes Kettunen     | Northern Finland Biobank Borealis / University of Oulu / Northern Ostrobothnia Hospital District, Oulu, Finland | johannes.kettunen@oulu.fi     | <a href="#">Scientific Committee</a> | University of Helsinki & Biobanks |
| Arto Mannermaa        | Biobank of Eastern Finland / University of Eastern Finland / Northern Savo Hospital District, Kuopio, Finland   | arto.mannermaa@uef.fi         | <a href="#">Scientific Committee</a> | University of Helsinki & Biobanks |
| Katriina Aalto-Setälä | Faculty of Medicine and Health Technology, Tampere University, Tampere, Finland                                 | katriina.aalto-setala@tuni.fi | <a href="#">Scientific Committee</a> | University of Helsinki & Biobanks |
| Mika Kähönen          | Finnish Clinical Biobank Tampere / University of Tampere / Pirkanmaa Hospital District, Tampere, Finland        | mika.kahonen@uta.fi           | <a href="#">Scientific Committee</a> | University of Helsinki & Biobanks |
| Jari Laukkanen        | Central Finland Biobank / University of Jyväskylä / Central Finland Health Care District, Jyväskylä, Finland    | jari.laukkanen@ksshp.fi       | <a href="#">Scientific Committee</a> | University of Helsinki & Biobanks |
| Johanna Mäkelä        | FINBB - Finnish biobank cooperative   | johanna.makela@finbb.fi       | <a href="#">Scientific Committee</a> | University of Helsinki & Biobanks |
| Reetta Kälviäinen     | Northern Savo Hospital District, Kuopio, Finland  | reetta.kalviainen@kuh.fi      | <a href="#">Clinical Groups</a>      | Neurology Group                   |
| Valtteri Julkunen     | Northern Savo Hospital District, Kuopio, Finland  | valtteri.julkunen@kuh.fi      | <a href="#">Clinical Groups</a>      | Neurology Group                   |
| Hilkka Soinen         | Northern Savo Hospital District, Kuopio, Finland  | hilkka.soininen@uef.fi        | <a href="#">Clinical Groups</a>      | Neurology Group                   |
| Anne Remes            | Northern Ostrobothnia Hospital District, Oulu, Finland  | anne.remes@oulu.fi            | <a href="#">Clinical Groups</a>      | Neurology Group                   |
| Mikko Hiltunen        | University of Eastern Finland, Kuopio, Finland  | mikko.hiltunen@uef.fi         | <a href="#">Clinical Groups</a>      | Neurology Group                   |
| Jukka Peltola         | Pirkanmaa Hospital District, Tampere, Finland   | jukka.peltola@pshp.fi         | <a href="#">Clinical Groups</a>      | Neurology Group                   |
| Minna Raivio          | Hospital District of Helsinki and Uusimaa, Helsinki, Finland  | minna.raivio@geri.fi          | <a href="#">Clinical Groups</a>      | Neurology Group                   |
| Pentti Tienari        | Hospital District of Helsinki and Uusimaa, Helsinki, Finland  | pentti.tienari@hus.fi         | <a href="#">Clinical Groups</a>      | Neurology Group                   |
| Juha Rinne            | Hospital District of Southwest Finland, Turku, Finland  | juha.rinne@tyks.fi            | <a href="#">Clinical Groups</a>      | Neurology Group                   |

|                      |   |                             |                                 |                               |
|----------------------|---|-----------------------------|---------------------------------|-------------------------------|
| Roosa Kallionpää     | Hospital District of Southwest Finland, Turku, Finland  | roosa.kallionpaa@tyks.fi    | <a href="#">Clinical Groups</a> | <b>Neurology Group</b>        |
| Juulia Partanen      | Institute for Molecular Medicine Finland, HiLIFE, University of Helsinki, Finland   | juulia.partanen@helsinki.fi | <a href="#">Clinical Groups</a> | <b>Neurology Group</b>        |
| Ali Abbasi           | Abbvie, Chicago, IL, United States  | ali.abbasi@abbvie.com       | <a href="#">Clinical Groups</a> | <b>Neurology Group</b>        |
| Adam Ziemann         | Abbvie, Chicago, IL, United States  | adam.ziemann@abbvie.com     | <a href="#">Clinical Groups</a> | <b>Neurology Group</b>        |
| Nizar Smaoui         | Abbvie, Chicago, IL, United States  | nizar.smaoui@abbvie.com     | <a href="#">Clinical Groups</a> | <b>Neurology Group</b>        |
| Anne Lehtonen        | Abbvie, Chicago, IL, United States  | anne.lehtonen@abbvie.com    | <a href="#">Clinical Groups</a> | <b>Neurology Group</b>        |
| Susan Eaton          | Biogen, Cambridge, MA, United States  | susan.eaton@biogen.com      | <a href="#">Clinical Groups</a> | <b>Neurology Group</b>        |
| Heiko Runz           | Biogen, Cambridge, MA, United States  | heiko.runz@biogen.com       | <a href="#">Clinical Groups</a> | <b>Neurology Group</b>        |
| Sanni Lahdenperä     | Biogen, Cambridge, MA, United States  | sanni.lahdenpera@biogen.com | <a href="#">Clinical Groups</a> | <b>Neurology Group</b>        |
| Shameek Biswas       | Bristol Myers Squibb, New York, NY, United States   | shameek.biswas@bms.com      | <a href="#">Clinical Groups</a> | <b>Neurology Group</b>        |
| Julie Hunkapiller    | Genentech, San Francisco, CA, United States   | hunkapiller.julie@gene.com  | <a href="#">Clinical Groups</a> | <b>Neurology Group</b>        |
| Natalie Bowers       | Genentech, San Francisco, CA, United States   | bowersn1@gene.com           | <a href="#">Clinical Groups</a> | <b>Neurology Group</b>        |
| Edmond Teng          | Genentech, San Francisco, CA, United States   | teng.edmond@gene.com        | <a href="#">Clinical Groups</a> | <b>Neurology Group</b>        |
| Rion Pendergrass     | Genentech, San Francisco, CA, United States   | penders2@gene.com           | <a href="#">Clinical Groups</a> | <b>Neurology Group</b>        |
| Fanli Xu             | GlaxoSmithKline, Brentford, United Kingdom  | chun-fang.2.xu@gsk.com      | <a href="#">Clinical Groups</a> | <b>Neurology Group</b>        |
| David Pulford        | GlaxoSmithKline, Stevenage, United Kingdom  | david.x.pulford@gsk.com     | <a href="#">Clinical Groups</a> | <b>Neurology Group</b>        |
| Kirsi Auro           | GlaxoSmithKline, Espoo, Finland   | kirsi.m.auro@gsk.com        | <a href="#">Clinical Groups</a> | <b>Neurology Group</b>        |
| Laura Addis          | GlaxoSmithKline, Brentford, United Kingdom  | laura.x.addis@gsk.com       | <a href="#">Clinical Groups</a> | <b>Neurology Group</b>        |
| John Eicher          | GlaxoSmithKline, Brentford, United Kingdom  | john.d.eicher@gsk.com       | <a href="#">Clinical Groups</a> | <b>Neurology Group</b>        |
| Qingqin S Li         | Janssen Research & Development, LLC, Titusville, NJ 08560, United States  | QLi2@its.jnj.com            | <a href="#">Clinical Groups</a> | <b>Neurology Group</b>        |
| Karen He             | Janssen Research & Development, LLC, Spring House, PA, United States  | khe2@its.jnj.com            | <a href="#">Clinical Groups</a> | <b>Neurology Group</b>        |
| Ekaterina Khramtsova | Janssen Research & Development, LLC, Spring House, PA, United States  | ekhamts@its.jnj.com         | <a href="#">Clinical Groups</a> | <b>Neurology Group</b>        |
| Neha Raghavan        | Merck, Kenilworth, NJ, United States  | neha.raghavan@merck.com     | <a href="#">Clinical Groups</a> | <b>Neurology Group</b>        |
| Martti Färkkilä      | Hospital District of Helsinki and Uusimaa, Helsinki, Finland  | martti.farkkila@hus.fi      | <a href="#">Clinical Groups</a> | <b>Gastroenterology Group</b> |
| Jukka Koskela        | Hospital District of Helsinki and Uusimaa, Helsinki, Finland  | jukka.koskela@helsinki.fi   | <a href="#">Clinical Groups</a> | <b>Gastroenterology Group</b> |
| Sampsa Pikkarainen   | Hospital District of Helsinki and Uusimaa, Helsinki, Finland  | sampsa.pikkarainen@hus.fi   | <a href="#">Clinical Groups</a> | <b>Gastroenterology Group</b> |
| Airi Jussila         | Pirkanmaa Hospital District, Tampere, Finland   | airi.jussila@pshp.fi        | <a href="#">Clinical Groups</a> | <b>Gastroenterology Group</b> |
| Katri Kaukinen       | Pirkanmaa Hospital District, Tampere, Finland   | katri.kaukinen@tuni.fi      | <a href="#">Clinical Groups</a> | <b>Gastroenterology Group</b> |
| Timo Blomster        | Northern Ostrobothnia Hospital District, Oulu, Finland  | timo.blomster@ppshp.fi      | <a href="#">Clinical Groups</a> | <b>Gastroenterology Group</b> |
| Mikko Kiviniemi      | Northern Savo Hospital District, Kuopio, Finland  | mikko.kiviniemi@kuh.fi      | <a href="#">Clinical Groups</a> | <b>Gastroenterology Group</b> |
| Markku Voutilainen   | Hospital District of Southwest Finland, Turku, Finland  | markku.voutilainen@tyks.fi  | <a href="#">Clinical Groups</a> | <b>Gastroenterology Group</b> |
| Mark Daly            | Institute for Molecular Medicine, Finland (FIMM), HiLIFE, University of Helsinki, Helsinki, Finland; Broad Institute of MIT and Harvard; Massachusetts General Hospital | mark.daly@helsinki.fi       | <a href="#">Clinical Groups</a> | <b>Gastroenterology Group</b> |
| Ali Abbasi           | Abbvie, Chicago, IL, United States  | ali.abbasi@abbvie.com       | <a href="#">Clinical Groups</a> | <b>Gastroenterology Group</b> |
| Jeffrey Waring       | Abbvie, Chicago, IL, United States  | jeff.waring@abbvie.com      | <a href="#">Clinical Groups</a> | <b>Gastroenterology Group</b> |

|                         |  |   |                                 |                               |
|-------------------------|--|---|---------------------------------|-------------------------------|
| Nizar Smaoui            | Abbvie, Chicago, IL, United States   | nizar.smaoui@abbvie.com                     | <a href="#">Clinical Groups</a> | <b>Gastroenterology Group</b> |
| Fedik Rahimov           | Abbvie, Chicago, IL, United States   | fedik.rahimov@abbvie.com                    | <a href="#">Clinical Groups</a> | <b>Gastroenterology Group</b> |
| Anne Lehtonen           | Abbvie, Chicago, IL, United States   | anne.lehtonen@abbvie.com                    | <a href="#">Clinical Groups</a> | <b>Gastroenterology Group</b> |
| Tim Lu                  | Genentech, San Francisco, CA, United States  | lut8@gene.com                               | <a href="#">Clinical Groups</a> | <b>Gastroenterology Group</b> |
| Natalie Bowers          | Genentech, San Francisco, CA, United States  | bowersn1@gene.com                           | <a href="#">Clinical Groups</a> | <b>Gastroenterology Group</b> |
| Rion Pendergrass        | Genentech, San Francisco, CA, United States  | penders2@gene.com                           | <a href="#">Clinical Groups</a> | <b>Gastroenterology Group</b> |
| Linda McCarthy          | GlaxoSmithKline, Brentford, United Kingdom   | linda.c.mccarthy@gsk.com                    | <a href="#">Clinical Groups</a> | <b>Gastroenterology Group</b> |
| Amy Hart                | Janssen Research & Development, LLC, Spring House, PA, United States                               | ahart13@its.jnj.com                         | <a href="#">Clinical Groups</a> | <b>Gastroenterology Group</b> |
| Meijian Guan            | Janssen Research & Development, LLC, Spring House, PA, United States                               | mguan4@its.jnj.com                          | <a href="#">Clinical Groups</a> | <b>Gastroenterology Group</b> |
| Jason Miller            | Merck, Kenilworth, NJ, United States   | jason.miller4@merck.com                     | <a href="#">Clinical Groups</a> | <b>Gastroenterology Group</b> |
| Kirsi Kalpala           | Pfizer, New York, NY, United States  | kirsi.kalpala@pfizer.com                    | <a href="#">Clinical Groups</a> | <b>Gastroenterology Group</b> |
| Melissa Miller          | Pfizer, New York, NY, United States  | melissa.r.miller@pfizer.com                 | <a href="#">Clinical Groups</a> | <b>Gastroenterology Group</b> |
| Xinli Hu                | Pfizer, New York, NY, United States  | xinli.hu@pfizer.com                         | <a href="#">Clinical Groups</a> | <b>Gastroenterology Group</b> |
| Kari Eklund             | Hospital District of Helsinki and Uusimaa, Helsinki, Finland                                       | kari.eklund@hus.fi                          | <a href="#">Clinical Groups</a> | <b>Rheumatology Group</b>     |
| Antti Palomäki          | Hospital District of Southwest Finland, Turku, Finland   | ajpalo@utu.fi                               | <a href="#">Clinical Groups</a> | <b>Rheumatology Group</b>     |
| Pia Isomäki             | Pirkanmaa Hospital District, Tampere, Finland  | pia.isomaki@pshp.fi                         | <a href="#">Clinical Groups</a> | <b>Rheumatology Group</b>     |
| Laura Pirilä            | Hospital District of Southwest Finland, Turku, Finland   | laura.pirila@fimnet.fi,laura.pirila@tyks.fi | <a href="#">Clinical Groups</a> | <b>Rheumatology Group</b>     |
| Oili Kaipainen-Seppänen | Northern Savo Hospital District, Kuopio, Finland   | oili.kaipainen-seppanen@kuh.fi              | <a href="#">Clinical Groups</a> | <b>Rheumatology Group</b>     |
| Johanna Huhtakangas     | Northern Ostrobothnia Hospital District, Oulu, Finland   | johanna.huhtakangas@kuh.fi                  | <a href="#">Clinical Groups</a> | <b>Rheumatology Group</b>     |
| Nina Mars               | Institute for Molecular Medicine Finland (FIMM), HiLIFE, University of Helsinki, Helsinki, Finland | nina.mars@helsinki.fi                       | <a href="#">Clinical Groups</a> | <b>Rheumatology Group</b>     |
| Ali Abbasi              | Abbvie, Chicago, IL, United States   | ali.abbasi@abbvie.com                       | <a href="#">Clinical Groups</a> | <b>Rheumatology Group</b>     |
| Jeffrey Waring          | Abbvie, Chicago, IL, United States   | jeff.waring@abbvie.com                      | <a href="#">Clinical Groups</a> | <b>Rheumatology Group</b>     |
| Fedik Rahimov           | Abbvie, Chicago, IL, United States   | fedik.rahimov@abbvie.com                    | <a href="#">Clinical Groups</a> | <b>Rheumatology Group</b>     |
| Apinya Lertratanakul    | Abbvie, Chicago, IL, United States   | apinya.lertratanakul@abbvie.com             | <a href="#">Clinical Groups</a> | <b>Rheumatology Group</b>     |
| Nizar Smaoui            | Abbvie, Chicago, IL, United States   | nizar.smaoui@abbvie.com                     | <a href="#">Clinical Groups</a> | <b>Rheumatology Group</b>     |
| Anne Lehtonen           | Abbvie, Chicago, IL, United States   | anne.lehtonen@abbvie.com                    | <a href="#">Clinical Groups</a> | <b>Rheumatology Group</b>     |
| David Close             | Astra Zeneca, Cambridge, United Kingdom  | david.close@astrazeneca.com                 | <a href="#">Clinical Groups</a> | <b>Rheumatology Group</b>     |
| Marla Hochfeld          | Bristol Myers Squibb, New York, NY, United States  | mhochfeld@celgene.com                       | <a href="#">Clinical Groups</a> | <b>Rheumatology Group</b>     |
| Natalie Bowers          | Genentech, San Francisco, CA, United States  | bowersn1@gene.com                           | <a href="#">Clinical Groups</a> | <b>Rheumatology Group</b>     |
| Rion Pendergrass        | Genentech, San Francisco, CA, United States  | penders2@gene.com                           | <a href="#">Clinical Groups</a> | <b>Rheumatology Group</b>     |
| Jorge Esparza Gordillo  | GlaxoSmithKline, Brentford, United Kingdom   | jorge.x.esparza-gordillo@gsk.com            | <a href="#">Clinical Groups</a> | <b>Rheumatology Group</b>     |
| Kirsi Auro              | GlaxoSmithKline, Espoo, Finland  | kirsi.m.auro@gsk.com                        | <a href="#">Clinical Groups</a> | <b>Rheumatology Group</b>     |
| Dawn Waterworth         | Janssen Research & Development, LLC, Spring House, PA, United States                               | dwaterwo@its.jnj.com                        | <a href="#">Clinical Groups</a> | <b>Rheumatology Group</b>     |
| Fabiana Farias          | Merck, Kenilworth, NJ, United States   | fabiana.farias@merck.com                    | <a href="#">Clinical Groups</a> | <b>Rheumatology Group</b>     |
| Kirsi Kalpala           | Pfizer, New York, NY, United States  | kirsi.kalpala@pfizer.com                    | <a href="#">Clinical Groups</a> | <b>Rheumatology Group</b>     |

|                       |   |                                   |                                 |                                       |
|-----------------------|---|-----------------------------------|---------------------------------|---------------------------------------|
| Nan Bing              | Pfizer, New York, NY, United States   | nan.bing@pfizer.com               | <a href="#">Clinical Groups</a> | <b>Rheumatology Group</b>             |
| Xnli Hu               | Pfizer, New York, NY, United States   | xinli.hu@pfizer.com               | <a href="#">Clinical Groups</a> | <b>Rheumatology Group</b>             |
| Tarja Laitinen        | Pirkanmaa Hospital District, Tampere, Finland   | tarja.laitinen@pshp.fi            | <a href="#">Clinical Groups</a> | <b>Pulmonology Group</b>              |
| Margit Pelkonen       | Northern Savo Hospital District, Kuopio, Finland  | margit.pelkonen@kuh.fi            | <a href="#">Clinical Groups</a> | <b>Pulmonology Group</b>              |
| Paula Kauppi          | Hospital District of Helsinki and Uusimaa, Helsinki, Finland  | paula.kauppi@hus.fi               | <a href="#">Clinical Groups</a> | <b>Pulmonology Group</b>              |
| Hannu Kankaanranta    | University of Gothenburg, Gothenburg, Sweden/ Seinäjoki Central Hospital, Seinäjoki, Finland/<br>Tampere University, Tampere, Finland | hannu.kankaanranta@tuni.fi        | <a href="#">Clinical Groups</a> | <b>Pulmonology Group</b>              |
| Terttu Harju          | Northern Ostrobothnia Hospital District, Oulu, Finland  | terttu.harju@oulu.fi              | <a href="#">Clinical Groups</a> | <b>Pulmonology Group</b>              |
| Riitta Lahesmaa       | Hospital District of Southwest Finland, Turku, Finland  | riilahes@utu.fi                   | <a href="#">Clinical Groups</a> | <b>Pulmonology Group</b>              |
| Nizar Smaoui          | Abbvie, Chicago, IL, United States  | nizar.smaoui@abbvie.com           | <a href="#">Clinical Groups</a> | <b>Pulmonology Group</b>              |
| Alex Mackay           | Astra Zeneca, Cambridge, United Kingdom   | alex.mackay@astrazeneca.com       | <a href="#">Clinical Groups</a> | <b>Pulmonology Group</b>              |
| Glenda Lassi          | Astra Zeneca, Cambridge, United Kingdom   | glenda.lassi@astrazeneca.com      | <a href="#">Clinical Groups</a> | <b>Pulmonology Group</b>              |
| Susan Eaton           | Biogen, Cambridge, MA, United States  | susan.eaton@biogen.com            | <a href="#">Clinical Groups</a> | <b>Pulmonology Group</b>              |
| Hubert Chen           | Genentech, San Francisco, CA, United States   | chenh37@gene.com                  | <a href="#">Clinical Groups</a> | <b>Pulmonology Group</b>              |
| Rion Pendergrass      | Genentech, San Francisco, CA, United States   | penders2@gene.com                 | <a href="#">Clinical Groups</a> | <b>Pulmonology Group</b>              |
| Natalie Bowers        | Genentech, San Francisco, CA, United States   | bowersn1@gene.com                 | <a href="#">Clinical Groups</a> | <b>Pulmonology Group</b>              |
| Joanna Betts          | GlaxoSmithKline, Brentford, United Kingdom  | joanna.c.betts@gsk.com            | <a href="#">Clinical Groups</a> | <b>Pulmonology Group</b>              |
| Kirsi Auro            | GlaxoSmithKline, Espoo, Finland   | kirsi.m.auro@gsk.com              | <a href="#">Clinical Groups</a> | <b>Pulmonology Group</b>              |
| Rajashree Mishra      | GlaxoSmithKline, Brentford, United Kingdom  | rajashree.x.mishra@gsk.com        | <a href="#">Clinical Groups</a> | <b>Pulmonology Group</b>              |
| Majd Mouded           | Novartis, Basel, Switzerland  | majd.mouded@novartis.com          | <a href="#">Clinical Groups</a> | <b>Pulmonology Group</b>              |
| Debby Ngo             | Novartis, Basel, Switzerland  | debby.ngo@novartis.com            | <a href="#">Clinical Groups</a> | <b>Pulmonology Group</b>              |
| Teemu Niiranen        | Finnish Institute for Health and Welfare (THL), Helsinki, Finland   | teemu.niiranen@thl.fi             | <a href="#">Clinical Groups</a> | <b>Cardiometabolic Diseases Group</b> |
| Felix Vaura           | Finnish Institute for Health and Welfare (THL), Helsinki, Finland   | fehva@utu.fi                      | <a href="#">Clinical Groups</a> | <b>Cardiometabolic Diseases Group</b> |
| Veikko Salomaa        | Finnish Institute for Health and Welfare (THL), Helsinki, Finland   | veikko.salomaa@thl.fi             | <a href="#">Clinical Groups</a> | <b>Cardiometabolic Diseases Group</b> |
| Kaj Metsärinne        | Hospital District of Southwest Finland, Turku, Finland  | kaj.metsarinne@tyks.fi            | <a href="#">Clinical Groups</a> | <b>Cardiometabolic Diseases Group</b> |
| Jenni Aittokallio     | Hospital District of Southwest Finland, Turku, Finland  | jemato@utu.fi                     | <a href="#">Clinical Groups</a> | <b>Cardiometabolic Diseases Group</b> |
| Mika Kähönen          | Pirkanmaa Hospital District, Tampere, Finland   | mika.kahonen@uta.fi               | <a href="#">Clinical Groups</a> | <b>Cardiometabolic Diseases Group</b> |
| Jussi Hernesniemi     | Pirkanmaa Hospital District, Tampere, Finland   | jussi.hernesniemi@tuni.fi         | <a href="#">Clinical Groups</a> | <b>Cardiometabolic Diseases Group</b> |
| Daniel Gordin         | Hospital District of Helsinki and Uusimaa, Helsinki, Finland  | daniel.gordin@hus.fi              | <a href="#">Clinical Groups</a> | <b>Cardiometabolic Diseases Group</b> |
| Juha Sinisalo         | Hospital District of Helsinki and Uusimaa, Helsinki, Finland  | juha.sinisalo@hus.fi              | <a href="#">Clinical Groups</a> | <b>Cardiometabolic Diseases Group</b> |
| Marja-Riitta Taskinen | Hospital District of Helsinki and Uusimaa, Helsinki, Finland  | marja-riitta.taskinen@helsinki.fi | <a href="#">Clinical Groups</a> | <b>Cardiometabolic Diseases Group</b> |
| Tiinamaija Tuomi      | Hospital District of Helsinki and Uusimaa, Helsinki, Finland  | tiinamaija.tuomi@hus.fi           | <a href="#">Clinical Groups</a> | <b>Cardiometabolic Diseases Group</b> |
| Timo Hiltunen         | Hospital District of Helsinki and Uusimaa, Helsinki, Finland  | timo.hiltunen@hus.fi              | <a href="#">Clinical Groups</a> | <b>Cardiometabolic Diseases Group</b> |
| Jari Laukkanen        | Central Finland Health Care District, Jyväskylä, Finland  | jari.laukkanen@ksshp.fi           | <a href="#">Clinical Groups</a> | <b>Cardiometabolic Diseases Group</b> |



|                      |   |                                  |                 |                                |
|----------------------|---|----------------------------------|-----------------|--------------------------------|
| Amanda Elliott       | Institute for Molecular Medicine Finland (FIMM), HiLIFE, University of Helsinki, Helsinki, Finland; Broad Institute, Cambridge, MA, USA and Massachusetts General Hospital, Boston, MA, USA | aelliott@broadinstitute.org      | Clinical Groups | Cardiometabolic Diseases Group |
| Mary Pat Reeve       | Institute for Molecular Medicine Finland (FIMM), HiLIFE, University of Helsinki, Helsinki, Finland  | mary.reeve@helsinki.fi           | Clinical Groups | Cardiometabolic Diseases Group |
| Sanni Ruotsalainen   | Institute for Molecular Medicine Finland (FIMM), HiLIFE, University of Helsinki, Helsinki, Finland  | sanni.ruotsalainen@helsinki.fi   | Clinical Groups | Cardiometabolic Diseases Group |
| Benjamin Challis     | Astra Zeneca, Cambridge, United Kingdom   | benjamin.challis@astrazeneca.com | Clinical Groups | Cardiometabolic Diseases Group |
| Dirk Paul            | Astra Zeneca, Cambridge, United Kingdom   | dirk.paul@astrazeneca.com        | Clinical Groups | Cardiometabolic Diseases Group |
| Julie Hunkapiller    | Genentech, San Francisco, CA, United States   | hunkapiller.julie@gene.com       | Clinical Groups | Cardiometabolic Diseases Group |
| Natalie Bowers       | Genentech, San Francisco, CA, United States   | bowersn1@gene.com                | Clinical Groups | Cardiometabolic Diseases Group |
| Rion Pendergrass     | Genentech, San Francisco, CA, United States   | penders2@gene.com                | Clinical Groups | Cardiometabolic Diseases Group |
| Audrey Chu           | GlaxoSmithKline, Brentford, United Kingdom  | audrey.y.chu@gsk.com             | Clinical Groups | Cardiometabolic Diseases Group |
| Kirsi Auro           | GlaxoSmithKline, Espoo, Finland   | kirsi.m.auro@gsk.com             | Clinical Groups | Cardiometabolic Diseases Group |
| Dermot Reilly        | Janssen Research & Development, LLC, Boston, MA, United States  | dreill11@its.jnj.com             | Clinical Groups | Cardiometabolic Diseases Group |
| Mike Mendelson       | Novartis, Boston, MA, United States   | mike.mendelson@novartis.com      | Clinical Groups | Cardiometabolic Diseases Group |
| Jaakko Parkkinen     | Pfizer, New York, NY, United States   | jaakko.parkkinen@pfizer.com      | Clinical Groups | Cardiometabolic Diseases Group |
| Melissa Miller       | Pfizer, New York, NY, United States   | melissa.r.miller@pfizer.com      | Clinical Groups | Cardiometabolic Diseases Group |
| Tuomo Meretoja       | Hospital District of Helsinki and Uusimaa, Helsinki, Finland  | tuomo.meretoja@hus.fi            | Clinical Groups | Oncology Group                 |
| Heikki Joensuu       | Hospital District of Helsinki and Uusimaa, Helsinki, Finland  | heikki.joensuu@hus.fi            | Clinical Groups | Oncology Group                 |
| Olli Carpen          | Hospital District of Helsinki and Uusimaa, Helsinki, Finland  | olli.carpen@helsinki.fi          | Clinical Groups | Oncology Group                 |
| Johanna Mattson      | Hospital District of Helsinki and Uusimaa, Helsinki, Finland  | johanna.mattson@hus.fi           | Clinical Groups | Oncology Group                 |
| Eveliina Salminen    | Hospital District of Helsinki and Uusimaa, Helsinki, Finland  | eveliina.e.salminen@hus.fi       | Clinical Groups | Oncology Group                 |
| Annika Auranen       | Pirkanmaa Hospital District, Tampere, Finland   | anaura@utu.fi                    | Clinical Groups | Oncology Group                 |
| Peeter Karihtala     | Northern Ostrobothnia Hospital District, Oulu, Finland  | peeter.karihtala@oulu.fi         | Clinical Groups | Oncology Group                 |
| Päivi Auvinen        | Northern Savo Hospital District, Kuopio, Finland  | paivi.auvinen@kuh.fi             | Clinical Groups | Oncology Group                 |
| Klaus Elenius        | Hospital District of Southwest Finland, Turku, Finland  | klaus.elenius@utu.fi             | Clinical Groups | Oncology Group                 |
| Johanna Schleutker   | Hospital District of Southwest Finland, Turku, Finland  | johanna.schleutker@utu.fi        | Clinical Groups | Oncology Group                 |
| Esa Pitkanen         | Institute for Molecular Medicine Finland (FIMM), HiLIFE, University of Helsinki, Helsinki, Finland  | esa.pitkanen@helsinki.fi         | Clinical Groups | Oncology Group                 |
| Nina Mars            | Institute for Molecular Medicine Finland (FIMM), HiLIFE, University of Helsinki, Helsinki, Finland  | nina.mars@helsinki.fi            | Clinical Groups | Oncology Group                 |
| Mark Daly            | Institute for Molecular Medicine Finland (FIMM), HiLIFE, University of Helsinki, Helsinki, Finland; Broad Institute of MIT and Harvard; Massachusetts General Hospital                      | mark.daly@helsinki.fi            | Clinical Groups | Oncology Group                 |
| Relja Popovic        | Abbvie, Chicago, IL, United States  | relja.popovic@abbvie.com         | Clinical Groups | Oncology Group                 |
| Jeffrey Waring       | Abbvie, Chicago, IL, United States  | jeff.waring@abbvie.com           | Clinical Groups | Oncology Group                 |
| Bridget Riley-Gillis | Abbvie, Chicago, IL, United States  | bridget.rileygillis@abbvie.com   | Clinical Groups | Oncology Group                 |
| Anne Lehtonen        | Abbvie, Chicago, IL, United States  | anne.lehtonen@abbvie.com         | Clinical Groups | Oncology Group                 |
| Jennifer Schutzman   | Genentech, San Francisco, CA, United States   | schutzman.jennifer@gene.com      | Clinical Groups | Oncology Group                 |
| Julie Hunkapiller    | Genentech, San Francisco, CA, United States   | hunkapiller.julie@gene.com       | Clinical Groups | Oncology Group                 |

|                          |   |                                 |                 |                     |
|--------------------------|---|---------------------------------|-----------------|---------------------|
| Natalie Bowers           | Genentech, San Francisco, CA, United States   | bowersn1@gene.com               | Clinical Groups | Oncology Group      |
| Rion Pendergrass         | Genentech, San Francisco, CA, United States   | penders2@gene.com               | Clinical Groups | Oncology Group      |
| Diptee Kulkarni          | GlaxoSmithKline, Brentford, United Kingdom  | diptee.a.kulkarni@gsk.com       | Clinical Groups | Oncology Group      |
| Kirsi Auro               | GlaxoSmithKline, Espoo, Finland   | kirsi.m.auro@gsk.com            | Clinical Groups | Oncology Group      |
| Alessandro Porello       | Janssen Research & Development, LLC, Spring House, PA, United States  | APorell@ITS.JNJ.com             | Clinical Groups | Oncology Group      |
| Andrey Loboda            | Merck, Kenilworth, NJ, United States  | andrey_loboda@merck.com         | Clinical Groups | Oncology Group      |
| Heli Lehtonen            | Pfizer, New York, NY, United States   | heli.lehtonen@pfizer.com        | Clinical Groups | Oncology Group      |
| Stefan McDonough         | Pfizer, New York, NY, United States   | stefan.McDonough@pfizer.com     | Clinical Groups | Oncology Group      |
| Sauli Vuoti              | Janssen-Cilag Oy, Espoo, Finland  | svuoti@its.jnj.com              | Clinical Groups | Oncology Group      |
| Kai Kaarniranta          | Northern Savo Hospital District, Kuopio, Finland  | kai.kaarniranta@uef.fi          | Clinical Groups | Ophthalmology Group |
| Joni A Turunen           | Helsinki University Hospital and University of Helsinki, Helsinki, Finland; Eye Genetics Group, Folkhälsan Research Center, Helsinki, Finland | joni.turunen@helsinki.fi        | Clinical Groups | Ophthalmology Group |
| Terhi Ollila             | Hospital District of Helsinki and Uusimaa, Helsinki, Finland  | terhi.ollila@hus.fi             | Clinical Groups | Ophthalmology Group |
| Hannu Uusitalo           | Pirkanmaa Hospital District, Tampere, Finland   | hannu.uusitalo@tuni.fi          | Clinical Groups | Ophthalmology Group |
| Juha Karjalainen         | Institute for Molecular Medicine Finland (FIMM), HiLIFE, University of Helsinki, Helsinki, Finland  | juha.karjalainen@helsinki.fi    | Clinical Groups | Ophthalmology Group |
| Esa Pitkanen             | Institute for Molecular Medicine Finland (FIMM), HiLIFE, University of Helsinki, Helsinki, Finland  | esa.pitkanen@helsinki.fi        | Clinical Groups | Ophthalmology Group |
| Mengzhen Liu             | Abbvie, Chicago, IL, United States  | mengzhen.liu@abbvie.com         | Clinical Groups | Ophthalmology Group |
| Heiko Runz               | Biogen, Cambridge, MA, United States  | heiko.runz@biogen.com           | Clinical Groups | Ophthalmology Group |
| Stephanie Loomis         | Biogen, Cambridge, MA, United States  | stephanie.loomis@biogen.com     | Clinical Groups | Ophthalmology Group |
| Erich Strauss            | Genentech, San Francisco, CA, United States   | strauss.erich@gene.com          | Clinical Groups | Ophthalmology Group |
| Natalie Bowers           | Genentech, San Francisco, CA, United States   | bowersn1@gene.com               | Clinical Groups | Ophthalmology Group |
| Hao Chen                 | Genentech, San Francisco, CA, United States   | haoc@gene.com                   | Clinical Groups | Ophthalmology Group |
| Rion Pendergrass         | Genentech, San Francisco, CA, United States   | penders2@gene.com               | Clinical Groups | Ophthalmology Group |
| Kaisa Tasanen            | Northern Ostrobothnia Hospital District, Oulu, Finland  | kaisa.tasanen-maatta@oulu.fi    | Clinical Groups | Dermatology Group   |
| Laura Huilaja            | Northern Ostrobothnia Hospital District, Oulu, Finland  | laura.huilaja@oulu.fi           | Clinical Groups | Dermatology Group   |
| Katariina Hannula-Jouppi | Hospital District of Helsinki and Uusimaa, Helsinki, Finland  | katariina.hannula-jouppi@hus.fi | Clinical Groups | Dermatology Group   |
| Teea Salmi               | Pirkanmaa Hospital District, Tampere, Finland   | teea.salmi@pshp.fi              | Clinical Groups | Dermatology Group   |
| Sirkku Peltonen          | Hospital District of Southwest Finland, Turku, Finland  | sipelto@utu.fi                  | Clinical Groups | Dermatology Group   |
| Leena Koulu              | Hospital District of Southwest Finland, Turku, Finland  | leena.koulu@tyks.fi             | Clinical Groups | Dermatology Group   |
| Nizar Smaoui             | Abbvie, Chicago, IL, United States  | nizar.smaoui@abbvie.com         | Clinical Groups | Dermatology Group   |
| Fedik Rahimov            | Abbvie, Chicago, IL, United States  | fedik.rahimov@abbvie.com        | Clinical Groups | Dermatology Group   |
| Anne Lehtonen            | Abbvie, Chicago, IL, United States  | anne.lehtonen@abbvie.com        | Clinical Groups | Dermatology Group   |
| David Choy               | Genentech, San Francisco, CA, United States   | choy.david@gene.com             | Clinical Groups | Dermatology Group   |
| Rion Pendergrass         | Genentech, San Francisco, CA, United States   | penders2@gene.com               | Clinical Groups | Dermatology Group   |
| Dawn Waterworth          | Janssen Research & Development, LLC, Spring House, PA, United States  | dwaterwo@its.jnj.com            | Clinical Groups | Dermatology Group   |

|                         |  |                                 |                                 |  |
|-------------------------|--|---------------------------------|---------------------------------|--|
| Kirsi Kalpala           | Pfizer, New York, NY, United States  | kirsi.kalpala@pfizer.com        | <a href="#">Clinical Groups</a> | <b>Dermatology Group</b>                     |
| Ying Wu                 | Pfizer, New York, NY, United States  | ying.wu3@pfizer.com             | <a href="#">Clinical Groups</a> | <b>Dermatology Group</b>                     |
| Pirkko Pussinen         | Hospital District of Helsinki and Uusimaa, Helsinki, Finland   | pirkko.pussinen@helsinki.fi     | <a href="#">Clinical Groups</a> | <b>Odontology Group</b>                      |
| Aino Salminen           | Hospital District of Helsinki and Uusimaa, Helsinki, Finland   | aino.m.salminen@helsinki.fi     | <a href="#">Clinical Groups</a> | <b>Odontology Group</b>                      |
| Tuula Salo              | Hospital District of Helsinki and Uusimaa, Helsinki, Finland   | tuula.salo@helsinki.fi          | <a href="#">Clinical Groups</a> | <b>Odontology Group</b>                      |
| David Rice              | Hospital District of Helsinki and Uusimaa, Helsinki, Finland   | david.rice@helsinki.fi          | <a href="#">Clinical Groups</a> | <b>Odontology Group</b>                      |
| Pekka Nieminen          | Hospital District of Helsinki and Uusimaa, Helsinki, Finland   | pekka.nieminen@helsinki.fi      | <a href="#">Clinical Groups</a> | <b>Odontology Group</b>                      |
| Ulla Palotie            | Hospital District of Helsinki and Uusimaa, Helsinki, Finland   | ulla.palotie@helsinki.fi        | <a href="#">Clinical Groups</a> | <b>Odontology Group</b>                      |
| Maria Siponen           | Northern Savo Hospital District, Kuopio, Finland   | maria.siponen@uef.fi            | <a href="#">Clinical Groups</a> | <b>Odontology Group</b>                      |
| Liisa Suominen          | Northern Savo Hospital District, Kuopio, Finland   | liisa.suominen@uef.fi           | <a href="#">Clinical Groups</a> | <b>Odontology Group</b>                      |
| Päivi Mäntylä           | Northern Savo Hospital District, Kuopio, Finland   | paivi.mantyla@uef.fi            | <a href="#">Clinical Groups</a> | <b>Odontology Group</b>                      |
| Ulvi Gursoy             | Hospital District of Southwest Finland, Turku, Finland   | ulvi.gursoy@utu.fi              | <a href="#">Clinical Groups</a> | <b>Odontology Group</b>                      |
| Vuokko Anttonen         | Northern Ostrobothnia Hospital District, Oulu, Finland   | vuokko.anttonen@oulu.fi         | <a href="#">Clinical Groups</a> | <b>Odontology Group</b>                      |
| Kirsi Sipilä            | Research Unit of Oral Health Sciences Faculty of Medicine, University of Oulu, Oulu, Finland;<br>Medical Research Center, Oulu, Oulu University Hospital and University of Oulu, Oulu, Finland | kirsi.sipila@oulu.fi            | <a href="#">Clinical Groups</a> | <b>Odontology Group</b>                      |
| Rion Pendergrass        | Genentech, San Francisco, CA, United States  | pendergrass.sarah@gene.com      | <a href="#">Clinical Groups</a> | <b>Odontology Group</b>                      |
| Hannele Laivuori        | Institute for Molecular Medicine Finland (FIMM), HiLIFE, University of Helsinki, Helsinki, Finland   | hannele.laivuori@helsinki.fi    | <a href="#">Clinical Groups</a> | <b>Women's Health and Reproduction Group</b> |
| Venla Kurra             | Pirkanmaa Hospital District, Tampere, Finland  | venla.kurra@tuni.fi             | <a href="#">Clinical Groups</a> | <b>Women's Health and Reproduction Group</b> |
| Laura Kotaniemi-Talonen | Pirkanmaa Hospital District, Tampere, Finland  | laura.kotaniemi-talonen@tuni.fi | <a href="#">Clinical Groups</a> | <b>Women's Health and Reproduction Group</b> |
| Oskari Heikinheimo      | Hospital District of Helsinki and Uusimaa, Helsinki, Finland   | oskari.heikinheimo@helsinki.fi  | <a href="#">Clinical Groups</a> | <b>Women's Health and Reproduction Group</b> |
| Ilkka Kalliala          | Hospital District of Helsinki and Uusimaa, Helsinki, Finland   | ilkka.kalliala@hus.fi           | <a href="#">Clinical Groups</a> | <b>Women's Health and Reproduction Group</b> |
| Lauri Aaltonen          | Hospital District of Helsinki and Uusimaa, Helsinki, Finland   | lauri.aaltonen@helsinki.fi      | <a href="#">Clinical Groups</a> | <b>Women's Health and Reproduction Group</b> |
| Varpu Jokimaa           | Hospital District of Southwest Finland, Turku, Finland   | varpu.jokimaa@utu.fi            | <a href="#">Clinical Groups</a> | <b>Women's Health and Reproduction Group</b> |
| Johannes Kettunen       | Northern Ostrobothnia Hospital District, Oulu, Finland   | Johannes.Kettunen@oulu.fi       | <a href="#">Clinical Groups</a> | <b>Women's Health and Reproduction Group</b> |
| Marja Väärasmäki        | Northern Ostrobothnia Hospital District, Oulu, Finland   | marja.vaarasmaki@oulu.fi        | <a href="#">Clinical Groups</a> | <b>Women's Health and Reproduction Group</b> |
| Outi Uimari             | Northern Ostrobothnia Hospital District, Oulu, Finland   | outi.uimari@oulu.fi             | <a href="#">Clinical Groups</a> | <b>Women's Health and Reproduction Group</b> |
| Laure Morin-Papunen     | Northern Ostrobothnia Hospital District, Oulu, Finland   | lmp@cc.oulu.fi                  | <a href="#">Clinical Groups</a> | <b>Women's Health and Reproduction Group</b> |
| Maarit Niinimäki        | Northern Ostrobothnia Hospital District, Oulu, Finland   | maarit.niinimaki@oulu.fi        | <a href="#">Clinical Groups</a> | <b>Women's Health and Reproduction Group</b> |
| Terhi Piltonen          | Northern Ostrobothnia Hospital District, Oulu, Finland   | terhi.piltonen@oulu.fi          | <a href="#">Clinical Groups</a> | <b>Women's Health and Reproduction Group</b> |
| Katja Kivinen           | Institute for Molecular Medicine Finland (FIMM), HiLIFE, University of Helsinki, Helsinki, Finland   | katja.kivinen@helsinki.fi       | <a href="#">Clinical Groups</a> | <b>Women's Health and Reproduction Group</b> |
| Elisabeth Widen         | Institute for Molecular Medicine Finland (FIMM), HiLIFE, University of Helsinki, Helsinki, Finland   | elisabeth.widen@helsinki.fi     | <a href="#">Clinical Groups</a> | <b>Women's Health and Reproduction Group</b> |
| Taru Tukiainen          | Institute for Molecular Medicine Finland (FIMM), HiLIFE, University of Helsinki, Helsinki, Finland   | taru.tukiainen@helsinki.fi      | <a href="#">Clinical Groups</a> | <b>Women's Health and Reproduction Group</b> |
| Mary Pat Reeve          | Institute for Molecular Medicine Finland (FIMM), HiLIFE, University of Helsinki, Helsinki, Finland   | mary.reeve@helsinki.fi          | <a href="#">Clinical Groups</a> | <b>Women's Health and Reproduction Group</b> |
| Mark Daly               | Institute for Molecular Medicine Finland (FIMM), HiLIFE, University of Helsinki, Helsinki, Finland;<br>Broad Institute of MIT and Harvard; Massachusetts General Hospital                      | mark.daly@helsinki.fi           | <a href="#">Clinical Groups</a> | <b>Women's Health and Reproduction Group</b> |

|                            |   |                                    |                                 |  |
|----------------------------|---|------------------------------------|---------------------------------|--|
| Niko Välimäki              | University of Helsinki, Helsinki, Finland   | niko.valimaki@helsinki.fi          | <a href="#">Clinical Groups</a> | <b>Women's Health and Reproduction Group</b> |
| Eija Laakkonen             | University of Jyväskylä, Jyväskylä, Finland   | eija.k.laakkonen@jyu.fi            | <a href="#">Clinical Groups</a> | <b>Women's Health and Reproduction Group</b> |
| Jaakko Tyrmi               | University of Oulu, Oulu, Finland / University of Tampere, Tampere, Finland   | jaakko.tyrmi@oulu.fi               | <a href="#">Clinical Groups</a> | <b>Women's Health and Reproduction Group</b> |
| Heidi Silven               | University of Oulu, Oulu, Finland   | heidi.silven@student.oulu.fi       | <a href="#">Clinical Groups</a> | <b>Women's Health and Reproduction Group</b> |
| Eeva Sliz                  | University of Oulu, Oulu, Finland   | eeva.sliz@oulu.fi                  | <a href="#">Clinical Groups</a> | <b>Women's Health and Reproduction Group</b> |
| Riikka Arffman             | University of Oulu, Oulu, Finland   | riikka.arffman@oulu.fi             | <a href="#">Clinical Groups</a> | <b>Women's Health and Reproduction Group</b> |
| Susanna Savukoski          | University of Oulu, Oulu, Finland   | susanna.savukoski@oulu.fi          | <a href="#">Clinical Groups</a> | <b>Women's Health and Reproduction Group</b> |
| Triin Laisk                | Estonian biobank, Tartu, Estonia  | triin.laisk@ut.ee                  | <a href="#">Clinical Groups</a> | <b>Women's Health and Reproduction Group</b> |
| Natalia Pujol              | Estonian biobank, Tartu, Estonia  | natalia.pujolgualdo@oulu.fi        | <a href="#">Clinical Groups</a> | <b>Women's Health and Reproduction Group</b> |
| Mengzhen Liu               | Abbvie, Chicago, IL, United States  | mengzhen.liu@abbvie.com            | <a href="#">Clinical Groups</a> | <b>Women's Health and Reproduction Group</b> |
| Bridget Riley-Gillis       | Abbvie, Chicago, IL, United States  | bridget.rileygillis@abbvie.com     | <a href="#">Clinical Groups</a> | <b>Women's Health and Reproduction Group</b> |
| Rion Pendergrass           | Genentech, San Francisco, CA, United States   | penders2@gene.com                  | <a href="#">Clinical Groups</a> | <b>Women's Health and Reproduction Group</b> |
| Janet Kumar                | GlaxoSmithKline, Collegeville, PA, United States  | janet.x.kumar@gsk.com              | <a href="#">Clinical Groups</a> | <b>Women's Health and Reproduction Group</b> |
| Kirsi Auro                 | GlaxoSmithKline, Espoo, Finland   | kirsi.m.auro@gsk.com               | <a href="#">Clinical Groups</a> | <b>Women's Health and Reproduction Group</b> |
| Iiris Hovatta              | University of Helsinki, Finland   | iiris.hovatta@helsinki.fi          | <a href="#">Clinical Groups</a> | <b>Depression group</b>                      |
| Chia-Yen Chen              | Biogen, Cambridge, MA, United States  | chiayen.chen@biogen.com            | <a href="#">Clinical Groups</a> | <b>Depression group</b>                      |
| Erkki Isometsä             | Hospital District of Helsinki and Uusimaa, Helsinki, Finland  | erkki.isometsa@hus.fi              | <a href="#">Clinical Groups</a> | <b>Depression group</b>                      |
| Kumar Veerapen             | Broad Institute, Cambridge, MA, United States   | veerapen@broadinstitute.org        | <a href="#">Clinical Groups</a> | <b>Depression group</b>                      |
| Hanna Ollila               | Institute for Molecular Medicine Finland (FIMM), HiLIFE, University of Helsinki, Helsinki, Finland                                    | hanna.m.ollila@helsinki.fi         | <a href="#">Clinical Groups</a> | <b>Depression group</b>                      |
| Jaana Suvisaari            | Finnish Institute for Health and Welfare (THL), Helsinki, Finland   | jaana.suvisaari@thl.fi             | <a href="#">Clinical Groups</a> | <b>Depression group</b>                      |
| Thomas Damm Als            | Aarhus University, Denmark  | tda@biomed.au.dk                   | <a href="#">Clinical Groups</a> | <b>Depression group</b>                      |
| Antti Mäkitie              | Department of Otorhinolaryngology - Head and Neck Surgery, University of Helsinki and Helsinki University Hospital, Helsinki, Finland | antti.makitie@helsinki.fi          | <a href="#">Clinical Groups</a> | <b>ENT (ear, nose and throat) Group</b>      |
| Argyro Bizaki-Vallaskangas | Pirkanmaa Hospital District, Tampere, Finland   | argyro.bizaki-vallaskangas@tuni.fi | <a href="#">Clinical Groups</a> | <b>ENT (ear, nose and throat) Group</b>      |
| Sanna Toppila-Salmi        | University of Helsinki, Finland   | sanna.salmi@helsinki.fi            | <a href="#">Clinical Groups</a> | <b>ENT (ear, nose and throat) Group</b>      |
| Tytti Willberg             | Hospital District of Southwest Finland, Turku, Finland  | tytti.willberg@tyks.fi             | <a href="#">Clinical Groups</a> | <b>ENT (ear, nose and throat) Group</b>      |
| Elmo Saarentaus            | Institute for Molecular Medicine Finland (FIMM), HiLIFE, University of Helsinki, Helsinki, Finland                                    | elmo.saarentaus@helsinki.fi        | <a href="#">Clinical Groups</a> | <b>ENT (ear, nose and throat) Group</b>      |
| Antti Aarnisalo            | Hospital District of Helsinki and Uusimaa, Helsinki, Finland  | antti.aarnisalo@hus.fi             | <a href="#">Clinical Groups</a> | <b>ENT (ear, nose and throat) Group</b>      |
| Eveliina Salminen          | Hospital District of Helsinki and Uusimaa, Helsinki, Finland  | eveliina.e.salminen@hus.fi         | <a href="#">Clinical Groups</a> | <b>ENT (ear, nose and throat) Group</b>      |
| Elisa Rahikkala            | Northern Ostrobothnia Hospital District, Oulu, Finland  | elisa.rahikkala@ppshp.fi           | <a href="#">Clinical Groups</a> | <b>ENT (ear, nose and throat) Group</b>      |
| Johannes Kettunen          | Northern Ostrobothnia Hospital District, Oulu, Finland  | johannes.kettunen@oulu.fi          | <a href="#">Clinical Groups</a> | <b>ENT (ear, nose and throat) Group</b>      |
| Kristiina Aittomäki        | Department of Medical Genetics, Helsinki University Central Hospital, Helsinki, Finland   | kristiina.aittomaki@helsinki.fi    | <a href="#">Clinical Groups</a> | <b>POI (premature ovarian failure) Group</b> |
| Fredrik Åberg              | Transplantation and Liver Surgery Clinic, Helsinki University Hospital, Helsinki University, Helsinki, Finland                        | fredrik.aberg@helsinki.fi          | <a href="#">Clinical Groups</a> | <b>LiverScore Group</b>                      |

|                             |   |                                       |
|-----------------------------|---|---------------------------------------|
| Mitja Kurki                 | Institute for Molecular Medicine Finland (FIMM), HiLIFE, University of Helsinki, Helsinki, Finland; Broad Institute, Cambridge, MA, United States                       | mkurki@broadinstitute.org             |
| Samuli Ripatti              | Institute for Molecular Medicine Finland (FIMM), HiLIFE, University of Helsinki, Helsinki, Finland  | samuli.ripatti@helsinki.fi            |
| Mark Daly                   | Institute for Molecular Medicine, Finland (FIMM), HiLIFE, University of Helsinki, Helsinki, Finland; Broad Institute of MIT and Harvard; Massachusetts General Hospital | mark.daly@helsinki.fi                 |
| Juha Karjalainen            | Institute for Molecular Medicine Finland (FIMM), HiLIFE, University of Helsinki, Helsinki, Finland  | juha.karjalainen@helsinki.fi          |
| Aki Hawulinna               | Institute for Molecular Medicine Finland (FIMM), HiLIFE, University of Helsinki, Helsinki, Finland  | aki.hawulinna@helsinki.fi             |
| Juha Mehtonen               | Institute for Molecular Medicine Finland (FIMM), HiLIFE, University of Helsinki, Helsinki, Finland  | juha.mehtonen@helsinki.fi             |
| Priit Palta                 | Institute for Molecular Medicine Finland (FIMM), HiLIFE, University of Helsinki, Helsinki, Finland  | priit.palta@helsinki.fi               |
| Shabbeer Hassan             | Institute for Molecular Medicine Finland (FIMM), HiLIFE, University of Helsinki, Helsinki, Finland  | shabbeer.hassan@helsinki.fi           |
| Pietro Della Briotta Parolo | Institute for Molecular Medicine Finland (FIMM), HiLIFE, University of Helsinki, Helsinki, Finland  | pietro.dellabriottaparolo@helsinki.fi |
| Wei Zhou                    | Broad Institute, Cambridge, MA, United States   | wzhou@broadinstitute.org              |
| Mutaamba Maasha             | Broad Institute, Cambridge, MA, United States   | mmaasha@broadinstitute.org            |
| Kumar Veerapen              | Broad Institute, Cambridge, MA, United States   | veerapen@broadinstitute.org           |
| Shabbeer Hassan             | Institute for Molecular Medicine Finland (FIMM), HiLIFE, University of Helsinki, Helsinki, Finland  | shabbeer.hassan@helsinki.fi           |
| Susanna Lemmelä             | Institute for Molecular Medicine Finland (FIMM), HiLIFE, University of Helsinki, Helsinki, Finland  | susanna.lemmela@helsinki.fi           |
| Manuel Rivas                | University of Stanford, Stanford, CA, United States   | mrivas@stanford.edu                   |
| Mari E. Niemi               | Institute for Molecular Medicine Finland (FIMM), HiLIFE, University of Helsinki, Helsinki, Finland  | mari.e.niemi@helsinki.fi              |
| Aarno Palotie               | Institute for Molecular Medicine Finland (FIMM), HiLIFE, University of Helsinki, Helsinki, Finland  | aarno.palotie@helsinki.fi             |
| Aoxing Liu                  | Institute for Molecular Medicine Finland (FIMM), HiLIFE, University of Helsinki, Helsinki, Finland  | aoxing.liu@helsinki.fi                |
| Arto Lehisto                | Institute for Molecular Medicine Finland (FIMM), HiLIFE, University of Helsinki, Helsinki, Finland  | arto.lehisto@helsinki.fi              |
| Andrea Ganna                | Institute for Molecular Medicine Finland (FIMM), HiLIFE, University of Helsinki, Helsinki, Finland  | aganna@broadinstitute.org             |
| Vincent Llorens             | Institute for Molecular Medicine Finland (FIMM), HiLIFE, University of Helsinki, Helsinki, Finland  | vincent.llorens@helsinki.fi           |
| Hannele Laivuori            | Institute for Molecular Medicine Finland (FIMM), HiLIFE, University of Helsinki, Helsinki, Finland  | hannele.laivuori@helsinki.fi          |
| Taru Tukiainen              | Institute for Molecular Medicine Finland (FIMM), HiLIFE, University of Helsinki, Helsinki, Finland  | taru.tukiainen@helsinki.fi            |
| Mary Pat Reeve              | Institute for Molecular Medicine Finland (FIMM), HiLIFE, University of Helsinki, Helsinki, Finland  | mary.reeve@helsinki.fi                |
| Henrike Heyne               | Institute for Molecular Medicine Finland (FIMM), HiLIFE, University of Helsinki, Helsinki, Finland  | hheyne@broadinstitute.org             |
| Nina Mars                   | Institute for Molecular Medicine Finland (FIMM), HiLIFE, University of Helsinki, Helsinki, Finland  | nina.mars@helsinki.fi                 |
| Joel Rämö                   | Institute for Molecular Medicine Finland (FIMM), HiLIFE, University of Helsinki, Helsinki, Finland  | joel.ramo@helsinki.fi                 |
| Elmo Saarentaus             | Institute for Molecular Medicine Finland (FIMM), HiLIFE, University of Helsinki, Helsinki, Finland  | elmo.saarentaus@helsinki.fi           |
| Hanna Ollila                | Institute for Molecular Medicine Finland (FIMM), HiLIFE, University of Helsinki, Helsinki, Finland  | hanna.m.ollila@helsinki.fi            |
| Rodos Rodosthenous          | Institute for Molecular Medicine Finland (FIMM), HiLIFE, University of Helsinki, Helsinki, Finland  | rodos.rodosthenous@helsinki.fi        |
| Satu Strausz                | Institute for Molecular Medicine Finland (FIMM), HiLIFE, University of Helsinki, Helsinki, Finland  | satu.strausz@helsinki.fi              |
| Tuula Palotie               | University of Helsinki and Hospital District of Helsinki and Uusimaa, Helsinki, Finland   | tuula.palotie@helsinki.fi             |
| Kimmo Palin                 | University of Helsinki, Helsinki, Finland   | kimmo.palin@helsinki.fi               |

[FinnGen Analysis working group](#)

[FinnGen Analysis working group](#)

[FinnGen Analysis working group](#)

[FinnGen Analysis working group](#)

[FinnGen Analysis working group](#)

[FinnGen Analysis working group](#)

[FinnGen Analysis working group](#)

[FinnGen Analysis working group](#)

[FinnGen Analysis working group](#)

[FinnGen Analysis working group](#)

[FinnGen Analysis working group](#)

[FinnGen Analysis working group](#)

[FinnGen Analysis working group](#)

[FinnGen Analysis working group](#)

[FinnGen Analysis working group](#)

[FinnGen Analysis working group](#)

[FinnGen Analysis working group](#)

[FinnGen Analysis working group](#)

[FinnGen Analysis working group](#)

[FinnGen Analysis working group](#)

[FinnGen Analysis working group](#)

[FinnGen Analysis working group](#)

[FinnGen Analysis working group](#)

[FinnGen Analysis working group](#)

[FinnGen Analysis working group](#)

[FinnGen Analysis working group](#)

[FinnGen Analysis working group](#)

[FinnGen Analysis working group](#)

[FinnGen Analysis working group](#)

[FinnGen Analysis working group](#)

[FinnGen Analysis working group](#)

[FinnGen Analysis working group](#)

[FinnGen Analysis working group](#)

|                        |   |                               |
|------------------------|---|-------------------------------|
| Javier Garcia-Tabuenca | University of Tampere, Tampere, Finland   | javier.graciatabuenca@tuni.fi |
| Harri Siirtola         | University of Tampere, Tampere, Finland   | harri.siirtola@tuni.fi        |
| Tuomo Kiiskinen        | Institute for Molecular Medicine Finland (FIMM), HiLIFE, University of Helsinki, Helsinki, Finland  | tuomo.kiiskinen@helsinki.fi   |
| Jiwoo Lee              | Institute for Molecular Medicine Finland (FIMM), HiLIFE, University of Helsinki, Helsinki, Finland; Broad Institute, Cambridge, MA, United States   | jiwoo.lee@helsinki.fi         |
| Kristin Tsuo           | Institute for Molecular Medicine Finland (FIMM), HiLIFE, University of Helsinki, Helsinki, Finland; Broad Institute, Cambridge, MA, United States   | kristintsuo@fas.harvard.edu   |
| Amanda Elliott         | Institute for Molecular Medicine Finland (FIMM), HiLIFE, University of Helsinki, Helsinki, Finland; Broad Institute, Cambridge, MA, USA and Massachusetts General Hospital, Boston, Finland | aelliott@broadinstitute.org   |
| Kati Kristiansson      | THL Biobank / Finnish Institute for Health and Welfare (THL), Helsinki, Finland   | kati.kristiansson@thl.fi      |
| Mikko Arvas            | Finnish Red Cross Blood Service / Finnish Hematology Registry and Clinical Biobank, Helsinki, Finland   | mikko.arvas@veripalvelu.fi    |
| Kati Hyvärinen         | Finnish Red Cross Blood Service, Helsinki, Finland  | kati.hyvarinen@veripalvelu.fi |
| Jarmo Ritari           | Finnish Red Cross Blood Service, Helsinki, Finland  | jarmo.ritari@veripalvelu.fi   |
| Olli Carpén            | Helsinki Biobank / Helsinki University and Hospital District of Helsinki and Uusimaa, Helsinki  | olli.carpén@helsinki.fi       |
| Johannes Kettunen      | Northern Finland Biobank Borealis / University of Oulu / Northern Ostrobothnia Hospital District, Oulu, Finland   | johannes.kettunen@oulu.fi     |
| Katri Pylkäs           | University of Oulu, Oulu, Finland   | katri.pylkas@oulu.fi          |
| Eeva Sliz              | University of Oulu, Oulu, Finland   | eeva.sliz@oulu.fi             |
| Minna Karjalainen      | University of Oulu, Oulu, Finland   | minna.k.karjalainen@oulu.fi   |
| Tuomo Mantere          | Northern Finland Biobank Borealis / University of Oulu / Northern Ostrobothnia Hospital District, Oulu, Finland   | tuomo.mantere@oulu.fi         |
| Eeva Kangasniemi       | Finnish Clinical Biobank Tampere / University of Tampere / Pirkanmaa Hospital District, Tampere, Finland  | eeva.kangasniemi@pshp.fi      |
| Sami Heikkinen         | University of Eastern Finland, Kuopio, Finland  | sami.heikkinen@uef.fi         |
| Arto Mannermaa         | Biobank of Eastern Finland / University of Eastern Finland / Northern Savo Hospital District, Kuopio, Finland   | arto.mannermaa@uef.fi         |
| Eija Laakkonen         | University of Jyväskylä, Jyväskylä, Finland   | eija.k.laakkonen@jyu.fi       |
| Nina Pitkanen          | Auria Biobank / University of Turku / Hospital District of Southwest Finland, Turku, Finland  | Niina.Pitkanen@tyks.fi        |
| Samuel Lessard         | Translational Sciences, Sanofi R&D, Framingham, MA, USA   | samuel.lessard@sanofi.com     |
| Clément Chatelain      | Translational Sciences, Sanofi R&D, Framingham, MA, USA   | clement.chatelain@sanofi.com  |
| Perttu Terho           | Auria Biobank / University of Turku / Hospital District of Southwest Finland, Turku, Finland  | perttu.terho@tyks.fi          |
| Sirpa Soini            | THL Biobank / Finnish Institute for Health and Welfare (THL), Helsinki, Finland   | sirpa.soini@thl.fi            |
| Jukka Partanen         | Finnish Red Cross Blood Service / Finnish Hematology Registry and Clinical Biobank, Helsinki, Finland   | jukka.partanen@veripalvelu.fi |

[FinnGen Analysis working group](#) [FinnGen Analysis working group](#)  
[FinnGen Analysis working group](#) [FinnGen Analysis working group](#)  
[FinnGen Analysis working group](#) [FinnGen Analysis working group](#)  
[FinnGen Analysis working group](#) [FinnGen Analysis working group](#)

[FinnGen Analysis working group](#) [FinnGen Analysis working group](#)

[FinnGen Analysis working group](#) [FinnGen Analysis working group](#)

[FinnGen Analysis working group](#) [FinnGen Analysis working group](#)  
[FinnGen Analysis working group](#) [FinnGen Analysis working group](#)

[FinnGen Analysis working group](#) [FinnGen Analysis working group](#)  
[FinnGen Analysis working group](#) [FinnGen Analysis working group](#)  
[FinnGen Analysis working group](#) [FinnGen Analysis working group](#)  
[FinnGen Analysis working group](#) [FinnGen Analysis working group](#)

[FinnGen Analysis working group](#) [FinnGen Analysis working group](#)  
[FinnGen Analysis working group](#) [FinnGen Analysis working group](#)  
[FinnGen Analysis working group](#) [FinnGen Analysis working group](#)  
[FinnGen Analysis working group](#) [FinnGen Analysis working group](#)

[FinnGen Analysis working group](#) [FinnGen Analysis working group](#)

[FinnGen Analysis working group](#) [FinnGen Analysis working group](#)  
[FinnGen Analysis working group](#) [FinnGen Analysis working group](#)

[FinnGen Analysis working group](#) [FinnGen Analysis working group](#)  
[FinnGen Analysis working group](#) [FinnGen Analysis working group](#)  
[FinnGen Analysis working group](#) [FinnGen Analysis working group](#)  
[FinnGen Analysis working group](#) [FinnGen Analysis working group](#)

[Biobank directors](#) [Biobank directors](#)  
[Biobank directors](#) [Biobank directors](#)  
[Biobank directors](#) [Biobank directors](#)

|                             |   |                                       |                                   |                                      |
|-----------------------------|---|---------------------------------------|-----------------------------------|--------------------------------------|
| Eero Punkka                 | Helsinki Biobank / Helsinki University and Hospital District of Helsinki and Uusimaa, Helsinki  | eero.punkka@hus.fi                    | <a href="#">Biobank directors</a> | <a href="#">Biobank directors</a>    |
| Raisa Serpi                 | Northern Finland Biobank Borealis / University of Oulu / Northern Ostrobothnia Hospital District, Oulu, Finland                                   | rais.a.serpi@ppshp.fi                 | <a href="#">Biobank directors</a> | <a href="#">Biobank directors</a>    |
| Sanna Siltanen              | Finnish Clinical Biobank Tampere / University of Tampere / Pirkanmaa Hospital District, Tampere, Finland  | sanna.siltanen@pshp.fi                | <a href="#">Biobank directors</a> | <a href="#">Biobank directors</a>    |
| Veli-Matti Kosma            | Biobank of Eastern Finland / University of Eastern Finland / Northern Savo Hospital District, Kuopio, Finland                                     | veli-matti.kosma@uef.fi               | <a href="#">Biobank directors</a> | <a href="#">Biobank directors</a>    |
| Teijo Kuopio                | Central Finland Biobank / University of Jyväskylä / Central Finland Health Care District, Jyväskylä, Finland                                      | teijo.kuopio@ksshp.fi                 | <a href="#">Biobank directors</a> | <a href="#">Biobank directors</a>    |
| Anu Jalanko                 | Institute for Molecular Medicine Finland (FIMM), HiLIFE, University of Helsinki, Helsinki, Finland  | anu.jalanko@helsinki.fi               | <a href="#">FinnGen Teams</a>     | <b>Administration</b>                |
| Huei-Yi Shen                | Institute for Molecular Medicine Finland (FIMM), HiLIFE, University of Helsinki, Helsinki, Finland  | huei-yi.shen@helsinki.fi              | <a href="#">FinnGen Teams</a>     | <b>Administration</b>                |
| Risto Kajanne               | Institute for Molecular Medicine Finland (FIMM), HiLIFE, University of Helsinki, Helsinki, Finland  | risto.kajanne@helsinki.fi             | <a href="#">FinnGen Teams</a>     | <b>Administration</b>                |
| Mervi Aavikko               | Institute for Molecular Medicine Finland (FIMM), HiLIFE, University of Helsinki, Helsinki, Finland  | mervi.aavikko@helsinki.fi             | <a href="#">FinnGen Teams</a>     | <b>Administration</b>                |
| Mitja Kurki                 | Institute for Molecular Medicine Finland (FIMM), HiLIFE, University of Helsinki, Helsinki, Finland; Broad Institute, Cambridge, MA, United States | mkurki@broadinstitute.org             | <a href="#">FinnGen Teams</a>     | <b>Analysis</b>                      |
| Juha Karjalainen            | Institute for Molecular Medicine Finland (FIMM), HiLIFE, University of Helsinki, Helsinki, Finland  | juha.karjalainen@helsinki.fi          | <a href="#">FinnGen Teams</a>     | <b>Analysis</b>                      |
| Pietro Della Briotta Parolo | Institute for Molecular Medicine Finland (FIMM), HiLIFE, University of Helsinki, Helsinki, Finland  | pietro.dellabriottaparolo@helsinki.fi | <a href="#">FinnGen Teams</a>     | <b>Analysis</b>                      |
| Arto Lehisto                | Institute for Molecular Medicine Finland (FIMM), HiLIFE, University of Helsinki, Helsinki, Finland  | arto.lehisto@helsinki.fi              | <a href="#">FinnGen Teams</a>     | <b>Analysis</b>                      |
| Juha Mehtonen               | Institute for Molecular Medicine Finland (FIMM), HiLIFE, University of Helsinki, Helsinki, Finland  | juha.mehtonen@helsinki.fi             | <a href="#">FinnGen Teams</a>     | <b>Analysis</b>                      |
| Wei Zhou                    | Broad Institute, Cambridge, MA, United States   | wzhou@broadinstitute.org              | <a href="#">FinnGen Teams</a>     | <b>Analysis</b>                      |
| Masahiro Kanai              | Broad Institute, Cambridge, MA, United States   | mkanai@broadinstitute.org             | <a href="#">FinnGen Teams</a>     | <b>Analysis</b>                      |
| Mutaamba Maasha             | Broad Institute, Cambridge, MA, United States   | mmaasha@broadinstitute.org            | <a href="#">FinnGen Teams</a>     | <b>Analysis</b>                      |
| Kumar Veerapen              | Broad Institute, Cambridge, MA, United States   | veerapen@broadinstitute.org           | <a href="#">FinnGen Teams</a>     | <b>Analysis</b>                      |
| Hannele Laivuori            | Institute for Molecular Medicine Finland (FIMM), HiLIFE, University of Helsinki, Helsinki, Finland  | hannele.laivuori@helsinki.fi          | <a href="#">FinnGen Teams</a>     | <b>Clinical Endpoint Development</b> |
| Aki Havulinna               | Institute for Molecular Medicine Finland (FIMM), HiLIFE, University of Helsinki, Helsinki, Finland  | aki.havulinna@helsinki.fi             | <a href="#">FinnGen Teams</a>     | <b>Clinical Endpoint Development</b> |
| Susanna Lemmelä             | Institute for Molecular Medicine Finland (FIMM), HiLIFE, University of Helsinki, Helsinki, Finland  | susanna.lemmela@helsinki.fi           | <a href="#">FinnGen Teams</a>     | <b>Clinical Endpoint Development</b> |
| Tuomo Kiiskinen             | Institute for Molecular Medicine Finland (FIMM), HiLIFE, University of Helsinki, Helsinki, Finland  | tuomo.kiiskinen@helsinki.fi           | <a href="#">FinnGen Teams</a>     | <b>Clinical Endpoint Development</b> |
| L. Elisa Lahtela            | Institute for Molecular Medicine Finland (FIMM), HiLIFE, University of Helsinki, Helsinki, Finland  | laura.lahtela@helsinki.fi             | <a href="#">FinnGen Teams</a>     | <b>Clinical Endpoint Development</b> |
| Mari Kaunisto               | Institute for Molecular Medicine Finland (FIMM), HiLIFE, University of Helsinki, Helsinki, Finland  | mari.kaunisto@helsinki.fi             | <a href="#">FinnGen Teams</a>     | <b>Communication</b>                 |
| Elina Kilpeläinen           | Institute for Molecular Medicine Finland (FIMM), HiLIFE, University of Helsinki, Helsinki, Finland  | elina.kilpelainen@helsinki.fi         | <a href="#">FinnGen Teams</a>     | <b>E-Science</b>                     |
| Timo P. Sipilä              | Institute for Molecular Medicine Finland (FIMM), HiLIFE, University of Helsinki, Helsinki, Finland  | timo.p.sipila@helsinki.fi             | <a href="#">FinnGen Teams</a>     | <b>E-Science</b>                     |
| Oluwaseun Alexander Dada    | Institute for Molecular Medicine Finland (FIMM), HiLIFE, University of Helsinki, Helsinki, Finland  | alexander.dada@helsinki.fi            | <a href="#">FinnGen Teams</a>     | <b>E-Science</b>                     |
| Awaisa Ghazal               | Institute for Molecular Medicine Finland (FIMM), HiLIFE, University of Helsinki, Helsinki, Finland  | awaisa.ghazal@helsinki.fi             | <a href="#">FinnGen Teams</a>     | <b>E-Science</b>                     |
| Anastasia Kytölä            | Institute for Molecular Medicine Finland (FIMM), HiLIFE, University of Helsinki, Helsinki, Finland  | anastasia.shcherban@helsinki.fi       | <a href="#">FinnGen Teams</a>     | <b>E-Science</b>                     |
| Rigbe Weldatsadik           | Institute for Molecular Medicine Finland (FIMM), HiLIFE, University of Helsinki, Helsinki, Finland  | rigbe.weldatsadik@helsinki.fi         | <a href="#">FinnGen Teams</a>     | <b>E-Science</b>                     |

|                        |  |                               |                               |  |
|------------------------|--|-------------------------------|-------------------------------|--|
| Kati Donner            | Institute for Molecular Medicine Finland (FIMM), HiLIFE, University of Helsinki, Helsinki, Finland | kati.donner@helsinki.fi       | <a href="#">FinnGen Teams</a> | <b>Genotyping</b>                          |
| Timo P. Sipilä         | Institute for Molecular Medicine Finland (FIMM), HiLIFE, University of Helsinki, Helsinki, Finland | timo.p.sipila@helsinki.fi     | <a href="#">FinnGen Teams</a> | <b>Genotyping</b>                          |
| Anu Loukola            | Helsinki Biobank / Helsinki University and Hospital District of Helsinki and Uusimaa, Helsinki     | anu.loukola@hus.fi            | <a href="#">FinnGen Teams</a> | <b>Sample Collection Coordination</b>      |
| Päivi Laiho            | THL Biobank / Finnish Institute for Health and Welfare (THL), Helsinki, Finland                    | paivi.laiho@thl.fi            | <a href="#">FinnGen Teams</a> | <b>Sample Logistics</b>                    |
| Tuuli Sistonen         | THL Biobank / Finnish Institute for Health and Welfare (THL), Helsinki, Finland                    | tuuli.sistonen@thl.fi         | <a href="#">FinnGen Teams</a> | <b>Sample Logistics</b>                    |
| Essi Kaiharju          | THL Biobank / Finnish Institute for Health and Welfare (THL), Helsinki, Finland                    | essi.kaiharju@thl.fi          | <a href="#">FinnGen Teams</a> | <b>Sample Logistics</b>                    |
| Markku Laukkanen       | THL Biobank / Finnish Institute for Health and Welfare (THL), Helsinki, Finland                    | markku.laukkanen@thl.fi       | <a href="#">FinnGen Teams</a> | <b>Sample Logistics</b>                    |
| Elina Järvensivu       | THL Biobank / Finnish Institute for Health and Welfare (THL), Helsinki, Finland                    | elina.jarvensivu@thl.fi       | <a href="#">FinnGen Teams</a> | <b>Sample Logistics</b>                    |
| Sini Lähteenmäki       | THL Biobank / Finnish Institute for Health and Welfare (THL), Helsinki, Finland                    | sini.lahteenmaki@thl.fi       | <a href="#">FinnGen Teams</a> | <b>Sample Logistics</b>                    |
| Lotta Männikkö         | THL Biobank / Finnish Institute for Health and Welfare (THL), Helsinki, Finland                    | lotta.mannikko@thl.fi         | <a href="#">FinnGen Teams</a> | <b>Sample Logistics</b>                    |
| Regis Wong             | THL Biobank / Finnish Institute for Health and Welfare (THL), Helsinki, Finland                    | regis.wong@thl.fi             | <a href="#">FinnGen Teams</a> | <b>Sample Logistics</b>                    |
| Auli Toivola           | THL Biobank / Finnish Institute for Health and Welfare (THL), Helsinki, Finland                    | auli.toivola@thl.fi           | <a href="#">FinnGen Teams</a> | <b>Sample Logistics</b>                    |
| Minna Brunfeldt        | THL Biobank / Finnish Institute for Health and Welfare (THL), Helsinki, Finland                    | minna.brunfeldt@thl.fi        | <a href="#">FinnGen Teams</a> | <b>Registry Data Operations</b>            |
| Hannele Mattsson       | THL Biobank / Finnish Institute for Health and Welfare (THL), Helsinki, Finland                    | hannele.mattsson@thl.fi       | <a href="#">FinnGen Teams</a> | <b>Registry Data Operations</b>            |
| Kati Kristiansson      | THL Biobank / Finnish Institute for Health and Welfare (THL), Helsinki, Finland                    | kati.kristiansson@thl.fi      | <a href="#">FinnGen Teams</a> | <b>Registry Data Operations</b>            |
| Susanna Lemmelä        | Institute for Molecular Medicine Finland (FIMM), HiLIFE, University of Helsinki, Helsinki, Finland | susanna.lemmela@helsinki.fi   | <a href="#">FinnGen Teams</a> | <b>Registry Data Operations</b>            |
| Sami Koskelainen       | THL Biobank / Finnish Institute for Health and Welfare (THL), Helsinki, Finland                    | sami.koskelainen@thl.fi       | <a href="#">FinnGen Teams</a> | <b>Registry Data Operations</b>            |
| Tero Hiekkalinna       | THL Biobank / Finnish Institute for Health and Welfare (THL), Helsinki, Finland                    | tero.hiekkalinna@helsinki.fi  | <a href="#">FinnGen Teams</a> | <b>Registry Data Operations</b>            |
| Teemu Paajanen         | THL Biobank / Finnish Institute for Health and Welfare (THL), Helsinki, Finland                    | teemu.paajanen@thl.fi         | <a href="#">FinnGen Teams</a> | <b>Registry Data Operations</b>            |
| Priit Palta            | Institute for Molecular Medicine Finland (FIMM), HiLIFE, University of Helsinki, Helsinki, Finland | priit.palta@helsinki.fi       | <a href="#">FinnGen Teams</a> | <b>Sequencing Informatics</b>              |
| Kalle Pärn             | Institute for Molecular Medicine Finland (FIMM), HiLIFE, University of Helsinki, Helsinki, Finland | kalle.parn@helsinki.fi        | <a href="#">FinnGen Teams</a> | <b>Sequencing Informatics</b>              |
| Mart Kals              | Institute for Molecular Medicine Finland (FIMM), HiLIFE, University of Helsinki, Helsinki, Finland | mart.kals@helsinki.fi         | <a href="#">FinnGen Teams</a> | <b>Sequencing Informatics</b>              |
| Shuang Luo             | Institute for Molecular Medicine Finland (FIMM), HiLIFE, University of Helsinki, Helsinki, Finland | shuang.luo@helsinki.fi        | <a href="#">FinnGen Teams</a> | <b>Sequencing Informatics</b>              |
| Vishal Sinha           | Institute for Molecular Medicine Finland (FIMM), HiLIFE, University of Helsinki, Helsinki, Finland | vishal.sinha@helsinki.fi      | <a href="#">FinnGen Teams</a> | <b>Sequencing Informatics</b>              |
| Tarja Laitinen         | Pirkanmaa Hospital District, Tampere, Finland  | tarja.laitinen@pshp.fi        | <a href="#">FinnGen Teams</a> | <b>Trajectory</b>                          |
| Mary Pat Reeve         | Institute for Molecular Medicine Finland (FIMM), HiLIFE, University of Helsinki, Helsinki, Finland | mary.reeve@helsinki.fi        | <a href="#">FinnGen Teams</a> | <b>Trajectory</b>                          |
| Marianna Niemi         | University of Tampere, Tampere, Finland  | marianna.niemi@tuni.fi        | <a href="#">FinnGen Teams</a> | <b>Trajectory</b>                          |
| Kumar Veerapen         | Broad Institute, Cambridge, MA, United States  | veerapen@broadinstitute.org   | <a href="#">FinnGen Teams</a> | <b>Trajectory</b>                          |
| Harri Siirtola         | University of Tampere, Tampere, Finland  | harri.siirtola@tuni.fi        | <a href="#">FinnGen Teams</a> | <b>Trajectory</b>                          |
| Javier Gracia-Tabuenca | University of Tampere, Tampere, Finland  | javier.graciatabuenca@tuni.fi | <a href="#">FinnGen Teams</a> | <b>Trajectory</b>                          |
| Mika Helminen          | University of Tampere, Tampere, Finland  | mika.helminen@tuni.fi         | <a href="#">FinnGen Teams</a> | <b>Trajectory</b>                          |
| Tiina Luukkaala        | University of Tampere, Tampere, Finland  | tiina.luukkaala@tuni.fi       | <a href="#">FinnGen Teams</a> | <b>Trajectory</b>                          |
| Iida Vähätalo          | University of Tampere, Tampere, Finland  | iida.vahatalo@epshp.fi        | <a href="#">FinnGen Teams</a> | <b>Trajectory</b>                          |
| Jyrki Pitkanen         | Institute for Molecular Medicine Finland (FIMM), HiLIFE, University of Helsinki, Helsinki, Finland | jyrki.pitkanen@helsinki.fi    | <a href="#">FinnGen Teams</a> | <b>Data protection officer</b>             |
| Marco Hautalahti       | Finnish Biobank Cooperative - FINBB  | marco.hautalahti@finbb.fi     | <a href="#">FinnGen Teams</a> | <b>FINBB - Finnish biobank cooperative</b> |



Johanna Mäkelä  
Sarah Smith  
Tom Southerington

Finnish Biobank Cooperative - FINBB  
Finnish Biobank Cooperative - FINBB  
Finnish Biobank Cooperative - FINBB

johanna.makela@finbb.fi  
sarah.smith@finbb.fi  
tom.southerington@finbb.fi

**FinnGen Teams**  
**FinnGen Teams**  
**FinnGen Teams**

**FINBB - Finnish biobank cooperative**  
**FINBB - Finnish biobank cooperative**  
**FINBB - Finnish biobank cooperative**