

1 **Modeling the COVID-19 outbreak in Ecuador: Is it the right time to lift social**
2 **distancing containment measures?**

3

4 Miguel REINA ORTIZ MD, PhD, CPH,¹ Vinita SHARMA,²

5

6 1 College of Public Health, University of South Florida, Tampa, FL – USA

7 2 College of Public Health, The University of Iowa, Iowa City, IA – USA

8

9

10

11 **Corresponding author**

12

13 Name: Miguel REINA ORTIZ

14 Postal address: 13201 Bruce B. Downs Blvd. Tampa, Fl 33647 USA.

15 email: miguelreina@usf.edu

16 Telephone: +1 (813) 974 6253

17 Fax: +1 (813) 974 8121

18 ORCID: <https://orcid.org/0000-0003-3309-6881>

19

20 Abstract word count: 220

21 Word count: 2,971

22

23 **ABSTRACT**

24 **Objective.** Model the effect of partial and full reversal of containment measures on
25 COVID-19 morbidity and mortality in Ecuador.

26 **Methods.** Susceptible, Infected, Recovered (SIR) models were used to simulate the
27 transmission dynamics of COVID-19 before and after the implementation (and
28 reversal) of containment measures. A Healthcare Compartmental Epidemic Model
29 (HeCEM), which accounts for Hospital and Intensive Care Unit admission rates, was
30 developed to also simulate the effect of reversing social distancing containment
31 measures. Reported COVID-19 cases between February 29th and April 23rd, 2020
32 were obtained from the Servicio Nacional de Gestión de Riesgos y Emergencia,
33 Ecuador's national emergency management office. An ARIMA model was used to
34 forecast reported number of cases based on the reported number of cases. SIR,
35 HeCEM, and ARIMA model prediction errors were estimated.

36 **Results.** SIR and HeCEM models predict that, at the moment, hospital and ICU bed
37 needs for COVID-19 patients exceed the capacity in Ecuador. Partial or full reversal
38 of containment measures before reaching the point where hospital and ICU beds are
39 enough to meet the expected demand will result in secondary waves that delay
40 reaching this equilibrium, resulting in thousands of excess deaths. Forecasts predict
41 over 50,000 reported COVID-19 cases by July 25th, 2020.

42 **Conclusion.** Partial reversal of containment measures should occur only after
43 enough hospital and beds are available to meet the demand.

44 INTRODUCTION

45 According to the World Health Organization (WHO), almost 4 million COVID-
46 19 cases and more than 250,000 COVID-19-related deaths had been reported
47 around the world as of May 10, 2020. (1) With over 28,000 cases, Ecuador ranks
48 sixth in terms of absolute number of cases in the Americas. (1) However, when
49 accounting for population size, Ecuador ranks third (first among Latin American
50 countries). Thus, Ecuador has become a regional COVID-19 pandemic epicenter for
51 the Latin American region.

52 Ecuador reported its first case of COVID-19 on February 29th, 2020, (2). The
53 country declared a State of Sanitary Emergency on March 11th, 2020, which entailed
54 suspension of school activities and a ban on gatherings of ≥ 250 people. (3) Since
55 March 17th, Ecuador has increased social distancing measures by progressively
56 restricting in-country mobility. (4, 5) Restrictions implemented since March 18th
57 include: 1) suspension of intercity transport;(5) 2) reduction of inner-city car
58 circulation;(5) and, 3) imposing a curfew, (5) among others.

59 In recent days, local governments have been given the authority to decide
60 when and how to move from more restrictive “red” to less restrictive “green” phases
61 in a 3-phased system resembling traffic lights. (6) The objective of this article is to
62 provide evidence to inform decisions on reversing containment measures by
63 conducting an epidemiological description of Ecuador’s COVID-19 outbreak, by
64 modeling the effect of partial reversal of containment measures under different
65 scenarios, and by forecasting predicted number of new reported COVID-19 cases in
66 the country.

67 **METHODS**

68 ***Study Population***

69 Ecuador is a country located in the northwest of South America. It borders
70 Colombia to the north, Peru to the east and south, and the Pacific Ocean lies to its
71 west. Ecuador also shares a maritime border with Costa Rica. The population of
72 Ecuador is estimated to be 17,084,357 in 2020. (7) The country is administratively
73 and politically subdivided into provinces, cantons, and parishes. There are 24
74 provinces and 221 cantons (8) in Ecuador.

75 ***Study design***

76 Based on secondary data analysis, an ecological study was conducted to
77 describe the epidemiological characteristics of Ecuador's COVID-19 outbreak,
78 including model-generated predictions and forecasts of future incidence and deaths.

79 ***Data collection***

80 Cumulative number of COVID-19 cases and cumulative number of COVID-19
81 deaths (per day) were obtained from the COVID-19 reports published by the
82 National Emergency Operations Committee (*COE Nacional*, in Spanish), Servicio
83 Nacional de Gestion de Riesgos (National Service of Risk Management), Government
84 of Ecuador. (9) Based on this data, we constructed a database of cumulative COVID-
85 19 cases and deaths from Day 0 of the outbreak (February 29th, 2020) (2) until April
86 23rd, 2020. Data collection stopped at April 23rd, 2020 because more than 10,000
87 cases (almost a 100% increase from the previous day) were added on April 24th,
88 2020 due to the inclusion of antibody-based test results, which had not been
89 reported until then (i.e. previous days were based on RT-PCR results).

90 **Data Analysis**

91 *Epidemic Models – SIR*

92 Compartmental deterministic models were simulated using the deSolve
93 package(10), R software (11), to compare the potential impact of reversing
94 containment measures on COVID-19 morbidity and mortality. Previous research has
95 suggested that Susceptible, Infected, Recovered (SIR) models are more appropriate
96 for modeling COVID-19 than Susceptible, Exposed, Infected, Recovered (SEIR)
97 models. (12)

98 We simulated SIR Models where the total population of Ecuador (as reported
99 by the World Bank)(7) was divided into Susceptible (S), Infectious (I), and
100 Recovered(R) compartments. Ecuador reported its first case of COVID-19 in
101 February 29th, 2020, (2) and this was selected as the starting date of the outbreak
102 for our models. We model the outbreak without any containment measures (Model
103 1), the effect of the enhanced social distancing measures enacted on May 18th
104 (Model 2). We also model the effect of full or partial reversal of current social
105 distancing measures at weekly intervals (on Sundays), starting on May 17th, 2020.
106 Model parameters were derived from the published literature. (13)

107 For each scenario, we found the time at which the demand of hospital and
108 ICU beds by COVID-19 patients no longer exceeds the capacity in Ecuador (i.e. after
109 the outbreak peak). We call this point *Post-peak Hospital* and *Post-Peak Intensive*
110 *Care Unit (ICU) Capacitance*. The number of hospital and Intensive Care Unit (ICU)
111 beds available were obtained from the National Institute of Statistics and Census.
112 (14) Hospital and ICU beds needed at any given point of time were calculated from

113 SIR model outputs using a 20% and a 2% ratio, respectively. (15) The number of
114 deaths at any given point of time was also calculated from SIR outputs by using a 2%
115 case fatality ratio. (15)

116 *Epidemic models (Healthcare)*

117 Since SIR models do not account for the time that an individual is likely to
118 remain in a hospital or ICU unit until either full recovery or death, we developed the
119 compartmental model shown in Figure 1. In this model, susceptible people become
120 infectious at a rate β (i.e. transmission rate). Infectious people can move into four
121 different compartments: 1) recovery, at a rate γ ; 2) hospitalization, at a rate θ ; 3)
122 ICU unit, at a rate ι ; or, 4) deceased, at a rate δ . Hospitalized patients either recover
123 at a rate ϵ or pass away at a rate χ whereas patients admitted to the ICU recovers at
124 a rate ω or pass away at a rate α . Of note, the model allows to account for hospital-
125 acquired infections, which occur at a rate ζ when hospitalized patients interact with
126 healthcare workers. Once infected, a healthcare worker moves to the infectious
127 compartment. The model also accounts for infections that healthcare workers may
128 acquire from interaction with infectious, but not hospitalized, individuals (see
129 Figure 1). Finally, the model estimates the number of reported cases (i.e. “observed”
130 cases) based on a reporting rate μ (not shown in Figure 1).

131 The Healthcare Compartmental Epidemic Model consists of the following
132 structure:

$$133 \quad \frac{dS}{dt} = -\beta SI$$

$$134 \quad \frac{dI}{dt} = \beta SI + \zeta WH + \beta WI - \gamma I - \theta I - \iota I - \delta I$$

$$135 \quad \frac{dH}{dt} = \theta I - \chi H - \epsilon H$$

136
$$dC/dt = \iota I - \alpha C - \omega C$$

137
$$dR/dt = \gamma I + \varepsilon H + \omega C$$

138
$$dD/dt = \delta I + \chi H + \alpha C$$

139
$$dW/dt = -\zeta WH - \beta WI$$

140
$$dO/dt = \mu I$$

141 Parameters were derived from the published literature (Table 1).

142 The total number of healthcare workers was obtained from the National
143 Institute of Statistics and Census. (20) We included the number of physicians, nurses
144 and nurse assistants and excluded dentists, psychologists and midwives, as the
145 latter were deemed less likely to enter in direct contact with a COVID-19 patient
146 during the early pandemic spread.

147 *Forecasting*

148 ARIMA models were used to forecast cumulative COVID-19 reported
149 incidence (i.e. number of reported cases by the system) beyond May 4th, 2020. In
150 order to avoid bias introduced by the change in method of reporting, the forecast
151 will be based on RT-PCR results, and only RT-PCR-confirmed cases will be
152 forecasted. Optimal order of differencing was determined by examining
153 autocorrelation function (ACF) and partial autocorrelation function (PACF) plots
154 (Figure S1) and by comparing root mean square error (RMSE) terms of the fitted
155 models (0, 1, and 2 orders of differencing were tested, at this point RMSE increased
156 without improving ACF and PACF plots). An inspection of the differentiated ACF and
157 PACF plots revealed a slightly significant positive autocorrelation at lag-1 (Figure
158 S1). Consequently, a

159 (first-order) differenced first-order autoregressive model was fitted, controlling for
160 outliers (AR parameter = 0.725, $p < 0.001$; Table S5) to forecast cumulative reported
161 incidence beyond May 4th (the date when the 3-phase traffic light system was
162 implemented). Forecast was stopped on July 25th, 2020. ARIMA models were fit
163 using SPSS 25. (21)

164 *Simulated and Predicted errors*

165 Simulated (SIR and HeCEM models) and predicted (ARIMA model) errors
166 were used to compare observed against simulated/predicted cumulative incidence.
167 In order to account for heteroscedasticity in the simulated/predicted errors,
168 standardized errors were computed. Afterwards, one-sample T (or Wilcoxon
169 signed-rank tests, as appropriate) analyses were conducted to assess whether error
170 means (or medians) were different than zero.

171 **RESULTS**

172 *Epidemiological characteristics of COVID-19 in Ecuador*

173 In Ecuador, the number of reported cases has increased at a mean rate of
174 25% (SD = 68.03; Figure 2). The weekly mean increase rate shows a steady but non-
175 monotonic decrease with the last two weeks showing a rate lower than 5%
176 compared to over 80% on the first week (Table S1). As of April 23rd, the cumulative
177 COVID-19 incidence curve still shows an upward trend with a total of 11,183 cases,
178 a 3.07% increase from the previous day.

179 The country reported its first COVID-19 fatality on March 13th. (22) Since
180 then, the cumulative number of deaths has increased at a mean rate of 18.61%. By
181 April 23rd, there were 560 cumulative COVID-19 deaths reported. Although the

182 mean number of reported deaths has remained relatively constant since Week 6, the
183 rate of increase has progressively decreased from 22.62% on Week 4 to 4.29% on
184 Week 9.

185 ***Simulating the COVID-19 outbreak in Ecuador***

186 Model 1 shows COVID-19 outbreak dynamics without accounting for the
187 effect of containment measures (Figure 3A). In that context, the peak of the
188 outbreak would have occurred on April 11th, 2020. Post-peak Hospital Capacitance
189 would have been reached on May 2nd whereas post-peak ICU Capacitance would
190 have been reached by May 10th.

191 Model 2 accounts for the restricting mobility social distancing measures
192 imposed in Ecuador on March 18th, 2020 (Figure 3B). The time of the policy change
193 (i.e. introduction of containment measures) effectively divides the model into Period
194 A (before the implementation of such measures) and Period B (after). After
195 accounting for the effect of containment measures, the peak of the COVID-19
196 outbreak is delayed until May 24th, 2020. Post-Peak Hospital Capacitance (HC)
197 would be reached on June 2nd whereas Post-peak ICU capacitance (ICU-C) would be
198 reached by July 14th. As shown in Table S2, the introduction of containment
199 measures is simulated to have reduced the number of new infections during the
200 outbreak peak by 90% and to have averted almost 138,000 deaths.

201 ***Impact of reversing containment measures on COVID-19 incidence***

202 In order to analyze the temporal dynamics of the COVID-19 outbreak in
203 Ecuador and to assess the impact that phasing out containment measures has on
204 simulated COVID-19 morbidity and mortality we developed *full reversal* and *partial*

205 *reversal* scenarios. Four full reversal (Models 3 to 6, Figures S2 to S5) and four
206 partial reversal scenarios (Models 7 to 10, Figures S6 to S8 and Figure 3C) are
207 presented. For each scenario, we assume that there will be a complete (or partial)
208 reversal of containment measures at different time points, which are designated as
209 “Policy change 2”. Each scenario is divided into three periods: 1) Period A, between
210 start of outbreak and “Policy change 1”; 2) Period B, between “Policy change 1” and
211 “Policy change 2”; and, 3) Period C, after “Policy change 2”.

212 *Full reversal scenarios*

213 All full reversal scenarios would result in excess deaths ranging from 5,043
214 to 127,745 (Table S4). Only a full reversal on May 17th would reach HC and ICU-C
215 earlier than Model 2 (by 7 and 17 days, respectively. However, fully reversing social
216 distancing containment measures by May 17th would result in an excess of 127,745
217 deaths. More detailed descriptions for each individual scenario are provided in
218 Supplemental Materials.

219 *Partial reversal scenarios*

220 Excess COVID-19 deaths range between 2,707 and 91,151. A partial reversal
221 on May 17th would result in HC and ICU-C being reached with 2 and 10 days of
222 anticipation but with a cost of over 90,000 deaths, compared to keeping
223 containment measures. The best scenario is provided by a partial reversal on July
224 9th, which would result in a 0- and 67-day delay for HC and ICU-C, compared with no
225 change in policy (Model 10, Figure 3C). Excess mortality of a partial reversal on July
226 9th would be 2,707 (Table S4). More detailed descriptions for each individual
227 scenario are provided in Supplemental Materials.

228 ***Simulating local COVID-19 outbreaks using HeCEM***

229 We used HeCEM to find the predicted dates of HC and ICU-C for Guayaquil
230 (Figure 4C, Model 13). ICU-C would be reached by June 30th whereas HC would be
231 reached on July 18th (Figure 4C, Model 13). By May 10th, the model predicts over 1.1
232 million persons having been infected with COVID-19 in the city and about 15,000
233 deaths. In addition, it is predicted that by May 10th over 6,500 healthcare workers
234 have been infected with COVID-19 in Guayaquil.

235 We also explored the use of HeCEM in a city where the COVID-19 outbreak
236 started after the enactment of containment measures. The first reported COVID-19
237 case was reported on March 21st in Esmeraldas. (23) According to HeCEM (Figure
238 4D, Model 14), ICU-C would be reached by August 13th whereas HC would be
239 reached 10 days later, by August 23rd. By May 10th, the model predicts that 4,814
240 people have been infected since the beginning of the outbreak and that 50 people
241 have died of COVID-19. The model also predicts that 32 healthcare workers would
242 have been infected with COVID-19 by May 10th.

243 ***Forecasting COVID-19 reported cases***

244 A differenced first-order autoregressive ARIMA model was fit to forecast the
245 cumulative COVID-19 incidence. The model was allowed to forecast up to July 25th.
246 According to the forecasting, reported cases will continue an upward trend until
247 reaching a total of 52,404 reported cases on July 25th (mean = 21,343, SD = 16,9830;
248 Figure 5).

249 ***Estimating simulation and predictive errors***

250 ARIMA model-generated errors were the most stable, at around -0.05 (Figure
251 S9). SIR model (Model 2) errors tend to decrease whereas HeCEM (Model 11) errors
252 increase with time (Figure S9). SIR-generated errors were larger than HeCEM-
253 generated errors (Table S6). ARIMA model-generated errors were not different than
254 zero (Table S6). HeCEM-generated standardized errors were not different than the
255 mean ($p = 0.446$, One-sample Wilcoxon Signed Rank test; Table S7).

256 **DISCUSSION**

257 Based on reported figures, Ecuador has one of the largest COVID-19
258 outbreaks in the Americas, (1) and the largest in Latin America (in terms of ratios).
259 However, the official figures are widely believed to underrepresent the true extent
260 of the outbreak. (24) Guayaquil, in particular, has suffered the greatest burden in the
261 country both in terms of morbidity and mortality. (25) The magnitude of the
262 outbreak in Guayaquil has been dramatic. There have been reports of corpses
263 accumulating on city streets after the local healthcare system was unable to cope
264 with the demand and due to the overwhelming of morgues and funeral homes. (26)

265 Severe social distancing measures consisting on mobility restrictions were
266 applied nationwide since March 18th, 2020. (5) Canton governments have been
267 authorized to evaluate conditions to reverse containment measures. (6) Some
268 cantons are considering lifting restrictions,(27) including Guayaquil that will keep
269 current containment measures until May 24th. (28) We used SIR and HeCEM
270 modeling to provide evidence that can inform decisions regarding reversing COVID-
271 19 containment measures in Ecuador.

272 The SIR and HeCEM models reported in this manuscript derive transmission
273 and infectiousness parameters from previous research studying COVID-19
274 transmission before and after the implementation of containment measures,
275 including restrictions in mobilization, in China. (13) In addition, HeCEM models
276 derive parameters from published literature as shown in Table 1. Since lockdown
277 efforts in Ecuador seem to have been loosely implemented, at least in some
278 regions,(29) it is likely that our estimates are rather conservative.

279 Our results suggest that Ecuador benefited from imposing containment
280 measures by reducing cumulative COVID-19 mortality by over 130,000. Of all
281 scenarios evaluated, the best outcome is given by delaying the implementation of a
282 partial reversal of measures until both Hospital Capacitance and ICU Capacitance
283 dates, under current circumstances, have been reached and stabilized. That
284 corresponds to SIR MODEL 10 (i.e. partial reversal implemented on July 19th, 2020).
285 HeCEM models may provide more accurate predictions, as they account for
286 hospitalization and ICU admittance in addition to recovery and death. HeCEM
287 models confirm that partial reversal of containment measures should occur after, or
288 right before, HC and ICU-C have been reached. The HeCEM Guayaquil model predicts
289 over 1.1 million cumulative infections by May 10th, 2020. A recent study conducted
290 in Guayaquil suggests that over 30% of the population (close to 1 million people)
291 have already been infected. (28) By April 30th, the HeCEM Guayaquil model
292 estimated 7,299 deaths, which correlates with the excess mortality observed in
293 Guayaquil (i.e. compared to 2019, there was an excess of 10,387 deaths between
294 March and April, as registered by the Civil Registry). (30) SIR-generated errors were

295 larger than HeCEM-generated errors suggesting that HeCEM models were more
296 accurate. However, HeCEM-generated errors showed a tendency to increase over
297 time. Estimating parameters from data generated on the field, in Ecuador, will help
298 to reduce both SIR and HeCEM errors and produce more accurate predictions.

299 Reversing containment measures should be carefully considered. The WHO
300 has indicated that COVID-19 cases may surge after lifting restrictions. (31) If
301 Ecuador follows a similar trajectory, then the resulting surge in cases will be
302 additional burden to an already overwhelmed healthcare system. Preventing
303 overwhelming healthcare services will be key to handling post-pandemic SARS-CoV-
304 2 transmission. (32) Prevention and control of cases in Ecuador, and specifically in
305 densely-populated cities like Guayaquil, could be crucial to keeping the pandemic
306 under control.

307 There are some limitations of this study. First, the study simulates the
308 outbreak for the whole nation. It is important to keep in mind that in-country
309 variations might exist. Similar approaches should be done at a local scale – we have
310 started by providing two local HeCEM models. Second, the models assume that once
311 a person recovers, they will not be re-infected. There is limited evidence regarding
312 lifelong COVID-19 immunity. (33) Third, our models do not consider the
313 socioeconomic impact of containment measures and therefore it does not include
314 them in the analysis of the impact of reversing such measures. In terms of
315 forecasting, the ARIMA models are based on the officially reported figures, which
316 are believed to be an underrepresentation of the real number of cases. (24)

317 **Acknowledgements**

318 The authors would like to thank Dr. Catalina Lopez-Quintero for her valuable
319 input.

320 **References**

- 321 1. World Health Organization. Coronavirus disease (COVID-19). Situation
322 Report 111. Available at: [https://www.who.int/docs/default-](https://www.who.int/docs/default-source/coronaviruse/situation-reports/20200510covid-19-sitrep-111.pdf?sfvrsn=1896976f_2)
323 [source/coronaviruse/situation-reports/20200510covid-19-sitrep-](https://www.who.int/docs/default-source/coronaviruse/situation-reports/20200510covid-19-sitrep-111.pdf?sfvrsn=1896976f_2)
324 [111.pdf?sfvrsn=1896976f_2](https://www.who.int/docs/default-source/coronaviruse/situation-reports/20200510covid-19-sitrep-111.pdf?sfvrsn=1896976f_2). WHO [Geneva], May 10, 2020. Cited May 10, 2020.
- 325 2. Gobierno de la República del Ecuador. Secretaría General de Comunicación
326 de la Presidencia. Se registra el primer caso de coronavirus en Ecuador [on line].
327 [https://www.comunicacion.gob.ec/se-registra-el-primer-caso-de-coronavirus-en-](https://www.comunicacion.gob.ec/se-registra-el-primer-caso-de-coronavirus-en-ecuador/)
328 [ecuador/](https://www.comunicacion.gob.ec/se-registra-el-primer-caso-de-coronavirus-en-ecuador/). Secretaría de Comunicación [Quito]. Cited April 29, 2020.
- 329 3. Gobierno de la República del Ecuador. Comité de Operaciones de Emergencia
330 Nacional. Informe de Situación COVID-19 Ecuador No. 001 | COE Nacional - 13 de
331 Marzo de 2020. Available at: [https://www.gestionderiesgos.gob.ec/wp-](https://www.gestionderiesgos.gob.ec/wp-content/uploads/2020/03/Informe-de-Situaci%C3%B3n-No001-Casos-Coronavirus-Ecuador-12032020.pdf)
332 [content/uploads/2020/03/Informe-de-Situaci%C3%B3n-No001-Casos-](https://www.gestionderiesgos.gob.ec/wp-content/uploads/2020/03/Informe-de-Situaci%C3%B3n-No001-Casos-Coronavirus-Ecuador-12032020.pdf)
333 [Coronavirus-Ecuador-12032020.pdf](https://www.gestionderiesgos.gob.ec/wp-content/uploads/2020/03/Informe-de-Situaci%C3%B3n-No001-Casos-Coronavirus-Ecuador-12032020.pdf). COE Nacional [Quito], March 13, 2020. Cited,
334 May 10, 2020.
- 335 4. Gobierno de la República del Ecuador. Comité de Operaciones de Emergencia
336 Nacional. Informe de Situación COVID-19 Ecuador No. 007 | COE Nacional - 16 de
337 Marzo de 2020 [on line]. Available at: [https://www.gestionderiesgos.gob.ec/wp-](https://www.gestionderiesgos.gob.ec/wp-content/uploads/2020/03/Informe-de-Situaci%C3%B3n-No007-Casos-Coronavirus-Ecuador-16032020-14h00.pdf)
338 [content/uploads/2020/03/Informe-de-Situaci%C3%B3n-No007-Casos-](https://www.gestionderiesgos.gob.ec/wp-content/uploads/2020/03/Informe-de-Situaci%C3%B3n-No007-Casos-Coronavirus-Ecuador-16032020-14h00.pdf)
339 [Coronavirus-Ecuador-16032020-14h00.pdf](https://www.gestionderiesgos.gob.ec/wp-content/uploads/2020/03/Informe-de-Situaci%C3%B3n-No007-Casos-Coronavirus-Ecuador-16032020-14h00.pdf). COE Nacional [Quito], March 16, 2020.
340 Cited, May 10, 2020.
- 341 5. Gobierno de la República del Ecuador. Comité de Operaciones de Emergencia
342 Nacional. Informe de Situación COVID-19 Ecuador No. 008 | COE Nacional - 16 de

- 343 Marzo de 2020 [on line]. Available at: [https://www.gestionderiesgos.gob.ec/wp-](https://www.gestionderiesgos.gob.ec/wp-content/uploads/2020/03/Informe-de-Situaci%C3%B3n-No008-Casos-Coronavirus-Ecuador-16032020-20h00.pdf)
344 [content/uploads/2020/03/Informe-de-Situaci%C3%B3n-No008-Casos-](https://www.gestionderiesgos.gob.ec/wp-content/uploads/2020/03/Informe-de-Situaci%C3%B3n-No008-Casos-Coronavirus-Ecuador-16032020-20h00.pdf)
345 [Coronavirus-Ecuador-16032020-20h00.pdf](https://www.gestionderiesgos.gob.ec/wp-content/uploads/2020/03/Informe-de-Situaci%C3%B3n-No008-Casos-Coronavirus-Ecuador-16032020-20h00.pdf). COE Nacional [Quito], March 16, 2020.
346 Cited, May 10, 2020.
- 347 6. Gobierno de la República del Ecuador. Comité de Operaciones de Emergencia
348 Nacional. Informe de Situación COVID-19 Ecuador No. 042 | COE Nacional - 29 de
349 Abril de 2020. Available at: [https://www.gestionderiesgos.gob.ec/wp-](https://www.gestionderiesgos.gob.ec/wp-content/uploads/2020/04/Informe-de-Situaci%C3%B3n-No042-Casos-Coronavirus-Ecuador-29042020.pdf)
350 [content/uploads/2020/04/Informe-de-Situaci%C3%B3n-No042-Casos-](https://www.gestionderiesgos.gob.ec/wp-content/uploads/2020/04/Informe-de-Situaci%C3%B3n-No042-Casos-Coronavirus-Ecuador-29042020.pdf)
351 [Coronavirus-Ecuador-29042020.pdf](https://www.gestionderiesgos.gob.ec/wp-content/uploads/2020/04/Informe-de-Situaci%C3%B3n-No042-Casos-Coronavirus-Ecuador-29042020.pdf). COE Nacional [Quito], April 29, 2020. Cited,
352 May 10, 2020.
- 353 7. The World Bank. World Bank Open Data. Data [onl ine].
354 <https://data.worldbank.org/>. The World Bank [Washington, D.C.] c. 2019. Cited
355 April 29, 2020.
- 356 8. Instituto Nacional de Estadística. Proyecciones Poblacionales. Instituto
357 Nacional de Estadística y Censos [on line].
358 <https://www.ecuadorencifras.gob.ec/proyecciones-poblacionales/>. INEN [Quito].
359 Cited April 29, 2020.
- 360 9. Servicio Nacional de Gestión de Riesgos y Emergencias. COE Nacional [on
361 line]. <https://www.gestionderiesgos.gob.ec/coe-nacional/>. [Quito]. Cited April 29,
362 2020.
- 363 10. Soetaert K, Petzoldt T, Setzer RW. Solving Differential Equations in R:
364 Package deSolve. 2010. 2010;33(9):25.
- 365 11. R Core Team (2020). R: A language and environment for

- 366 statistical computing. R Foundation for Statistical
367 Computing, Vienna, Austria. URL <https://www.R-project.org/>. Cited April 29, 2020.
- 368 12. Huang Y, Yang L, Dai H, Tian F & Chen K. Epidemic situation and forecasting
369 of COVID-19 in and outside China. [Submitted]. Bull World Health Organ. E-pub: 16
370 March 2020. doi:
371 <http://dx.doi.org/10.2471/BLT.20.255158>.
- 372 13. Li R, Pei S, Chen B, Song Y, Zhang T, Yang W, et al. Substantial undocumented
373 infection facilitates the rapid dissemination of novel coronavirus (SARS-CoV2).
374 Science. 2020.
- 375 14. Gobierno de la República del Ecuador. Instituto Nacional de Estadísticas y
376 Censos. Camas y egresos hospitalarios [on line].
377 <https://www.ecuadorencifras.gob.ec/camas-y-egresos-hospitalarios/>. INEN [Quito],
378 n.d. Cited, May 6, 2020.
- 379 15. Team CC-R. Severe Outcomes Among Patients with Coronavirus Disease
380 2019 (COVID-19) - United States, February 12-March 16, 2020. MMWR Morb Mortal
381 Wkly Rep. 2020;69(12):343-6.
- 382 16. Verity R, Okell LC, Dorigatti I, Winskill P, Whittaker C, Imai N, et al. Estimates
383 of the severity of coronavirus disease 2019: a model-based analysis. Lancet Infect
384 Dis. 2020.
- 385 17. Garg S, Kim L, Whitaker M, O'Halloran A, Cummings C, Holstein R, et al.
386 Hospitalization Rates and Characteristics of Patients Hospitalized with Laboratory-
387 Confirmed Coronavirus Disease 2019 - COVID-NET, 14 States, March 1-30, 2020.
388 MMWR Morb Mortal Wkly Rep. 2020;69(15):458-64.

- 389 18. Huang C, Wang Y, Li X, Ren L, Zhao J, Hu Y, et al. Clinical features of patients
390 infected with 2019 novel coronavirus in Wuhan, China. *Lancet*.
391 2020;395(10223):497-506.
- 392 19. Wu Z, McGoogan JM. Characteristics of and Important Lessons From the
393 Coronavirus Disease 2019 (COVID-19) Outbreak in China: Summary of a Report of
394 72314 Cases From the Chinese Center for Disease Control and Prevention. *JAMA*.
395 2020.
- 396 20. Gobierno de la República del Ecuador. Instituto Nacional de Estadísticas y
397 Censos. Actividades y Recursos de Salud [on line]. Available at:
398 <https://www.ecuadorencifras.gob.ec/actividades-y-recursos-de-salud/>. INEN
399 [Quito], n.d. Cited, May 6, 2020.
- 400 21. IBM Corp. Released 2017. IBM SPSS Statistics for Windows, Version 25.0.
401 Armonk, NY: IBM Corp.
- 402 22. Heredia, V, Gonzalez, J. Murió la primera paciente que dio positivo a covid-19
403 en Ecuador, informó el MSP; hay tres nuevos casos.
404 [https://www.elcomercio.com/actualidad/murio-primera-paciente-coronavirus-](https://www.elcomercio.com/actualidad/murio-primera-paciente-coronavirus-ecuador.html)
405 [ecuador.html](https://www.elcomercio.com/actualidad/murio-primera-paciente-coronavirus-ecuador.html). March 13, 2020. Accessed April 30, 2020.
- 406 23. Gobierno de la República del Ecuador. Comité de Operaciones de Emergencia
407 Nacional. Informe de Situación COVID-19 Ecuador No. 016 | COE Nacional - 21 de
408 Marzo de 2020 [on line]. Available at: [https://www.gestionderiesgos.gob.ec/wp-](https://www.gestionderiesgos.gob.ec/wp-content/uploads/2020/03/Informe-de-Situaci%C3%B3n-No016-Casos-Coronavirus-Ecuador-21032020.pdf)
409 [content/uploads/2020/03/Informe-de-Situaci%C3%B3n-No016-Casos-](https://www.gestionderiesgos.gob.ec/wp-content/uploads/2020/03/Informe-de-Situaci%C3%B3n-No016-Casos-Coronavirus-Ecuador-21032020.pdf)
410 [Coronavirus-Ecuador-21032020.pdf](https://www.gestionderiesgos.gob.ec/wp-content/uploads/2020/03/Informe-de-Situaci%C3%B3n-No016-Casos-Coronavirus-Ecuador-21032020.pdf). COE Nacional [Quito], Mar 21, 2020. Cited, May
411 10, 2020.

- 412 24. Otis J. COVID-19 Numbers Are Bad In Ecuador. The President Says The Real
413 Story Is Even Worse.
414 <https://www.npr.org/sections/goatsandsoda/2020/04/20/838746457/covid-19->
415 [numbers-are-bad-in-ecuador-the-president-says-the-real-story-is-even-wo.](https://www.npr.org/sections/goatsandsoda/2020/04/20/838746457/covid-19-numbers-are-bad-in-ecuador-the-president-says-the-real-story-is-even-wo-)
416 National Public Radio, April 20, 2020. Cited May 14, 2020.
- 417 25. Gobierno de la República del Ecuador. Comité de Operaciones de Emergencia
418 Nacional. Infografía No 073 COVID 19 | COE Nacional - 10 de Mayo de 2020 [on line].
419 Available at: [https://www.gestionderiesgos.gob.ec/wp-](https://www.gestionderiesgos.gob.ec/wp-content/uploads/2020/03/Resoluciones-COE-Nacional-24-de-marzo-2020.pdf)
420 [content/uploads/2020/03/Resoluciones-COE-Nacional-24-de-marzo-2020.pdf](https://www.gestionderiesgos.gob.ec/wp-content/uploads/2020/03/Resoluciones-COE-Nacional-24-de-marzo-2020.pdf). COE
421 Nacional [Quito], May 10, 2020. Cited, May 10, 2020.
- 422 26. Rivers M, Gallón N. Where are the bodies? Missing remains mean no peace for
423 grieving families in Ecuador [on line]. Cable News Network. May 10, 2020.
424 [https://www.cnn.com/2020/05/07/americas/ecuador-coronavirus-missing-](https://www.cnn.com/2020/05/07/americas/ecuador-coronavirus-missing-intl/index.html)
425 [intl/index.html](https://www.cnn.com/2020/05/07/americas/ecuador-coronavirus-missing-intl/index.html). Cited May 10, 2020.
- 426 27. Medina A. 166 cantones se quedarán con semáforo en rojo hasta el 31 de
427 mayo. El Comercio. [https://www.elcomercio.com/actualidad/cantones-semaforo-](https://www.elcomercio.com/actualidad/cantones-semaforo-rojo-covid19-distanciamiento.html)
428 [rojo-covid19-distanciamiento.html](https://www.elcomercio.com/actualidad/cantones-semaforo-rojo-covid19-distanciamiento.html). May 5, 2020. Accessed May 6, 2020.
- 429 28. El Universo. Coronavirus en Guayaquil: Semáforo en rojo se mantendrá hasta
430 el 24 de mayo; según muestreo, el 33% de la población se ha contagiado, de esos el
431 14,8% ha superado la enfermedad [on line]. Available at:
432 [https://www.eluniverso.com/guayaquil/2020/05/07/nota/7834590/guayaquil-](https://www.eluniverso.com/guayaquil/2020/05/07/nota/7834590/guayaquil-coronavirus-medidas-coe)
433 [coronavirus-medidas-coe](https://www.eluniverso.com/guayaquil/2020/05/07/nota/7834590/guayaquil-coronavirus-medidas-coe). El Universo [Guayaquil], May 7, 2020. Cited May 10, 2020.

- 434 29. Torres I, Sacoto F. Localising an asset-based COVID-19 response in Ecuador.
435 Lancet. 2020;395(10233):1339.
- 436 30. Ecuavisa. Muertos sin descanso | Visión 360 VII Temporada [video, on line].
437 Available: <https://www.youtube.com/watch?v=gXP2eJW5hnA>. Ecuavisa [Quito],
438 May 11, 2020. Cited May 12, 2020.
- 439 31. World Health Organization. WHO Director-General's opening remarks at the
440 media briefing on COVID-19 - 11 May 2020 [on line].
441 [https://www.who.int/dg/speeches/detail/who-director-general-s-opening-](https://www.who.int/dg/speeches/detail/who-director-general-s-opening-remarks-at-the-media-briefing-on-covid-19---11-may-2020)
442 [remarks-at-the-media-briefing-on-covid-19---11-may-2020](https://www.who.int/dg/speeches/detail/who-director-general-s-opening-remarks-at-the-media-briefing-on-covid-19---11-may-2020). WHO [Geneva], May 11,
443 2020. Cited May 12, 2020.
- 444 32. Kissler SM, Tedijanto C, Goldstein E, Grad YH, Lipsitch M. Projecting the
445 transmission dynamics of SARS-CoV-2 through the postpandemic period. Science.
446 2020.
- 447 33. Kirkcaldy RD, King BA, Brooks JT. COVID-19 and Postinfection Immunity:
448 Limited Evidence, Many Remaining Questions. JAMA. 2020.

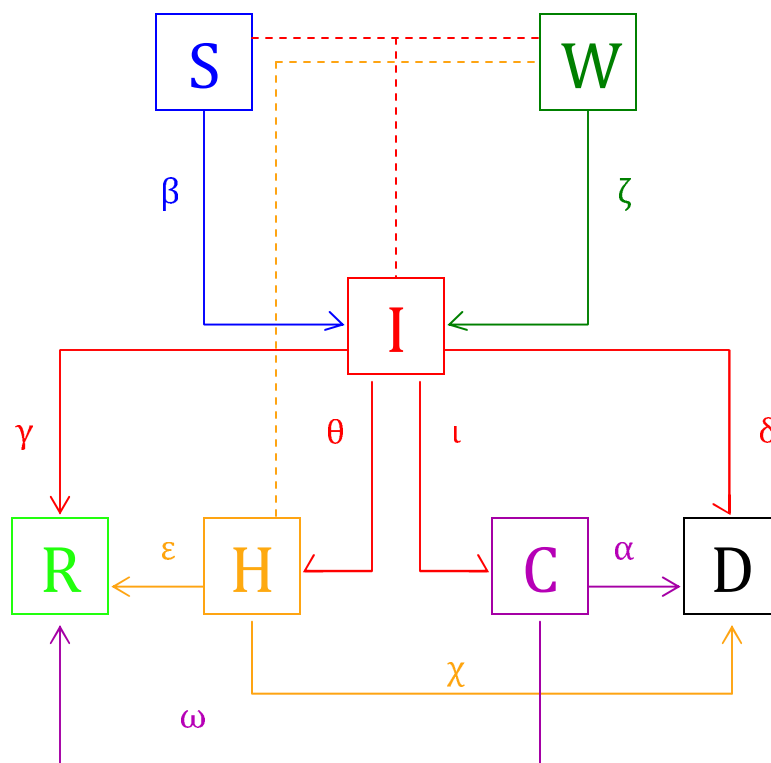

Figure 1. Healthcare Compartmental Epidemic Model.

S = Susceptibles, W = Healthcare Workers, I = Infectious, R = Recovered, H = Hospitalized, C = admitted to ICU units, D = deceased. Greek letters represent the rate at which individuals move from one compartment to another. Arrows represent the direction of the inter-compartmental movement. Dashed lines represent interactions between people in different compartments that may result in infections.

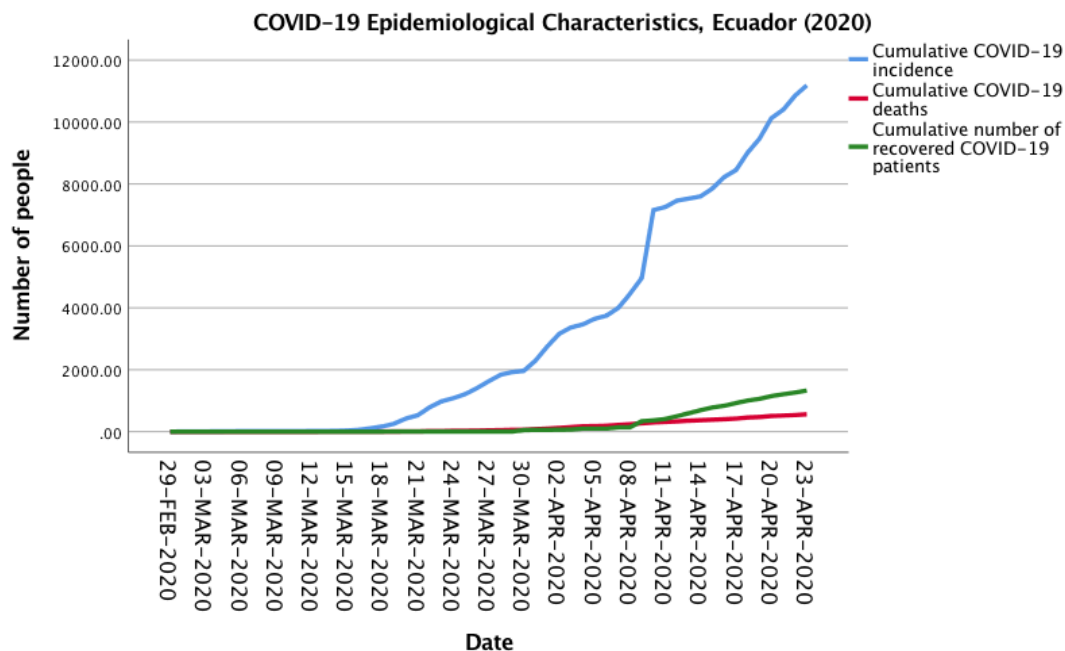

Figure 2. Epidemiological characteristics of the COVID-19 outbreak in Ecuador

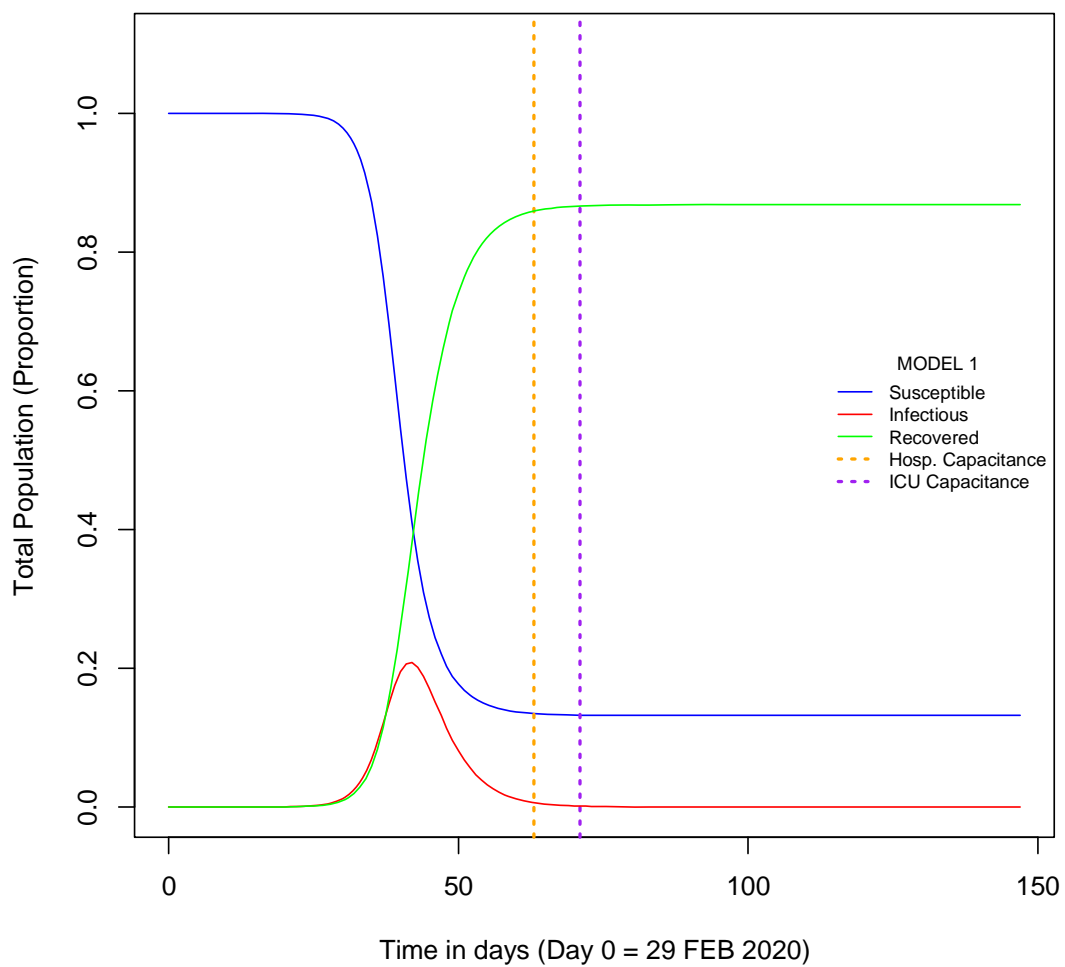

Figure 3A. MODEL 1: Ecuador COVID-19 initial SIR Model.

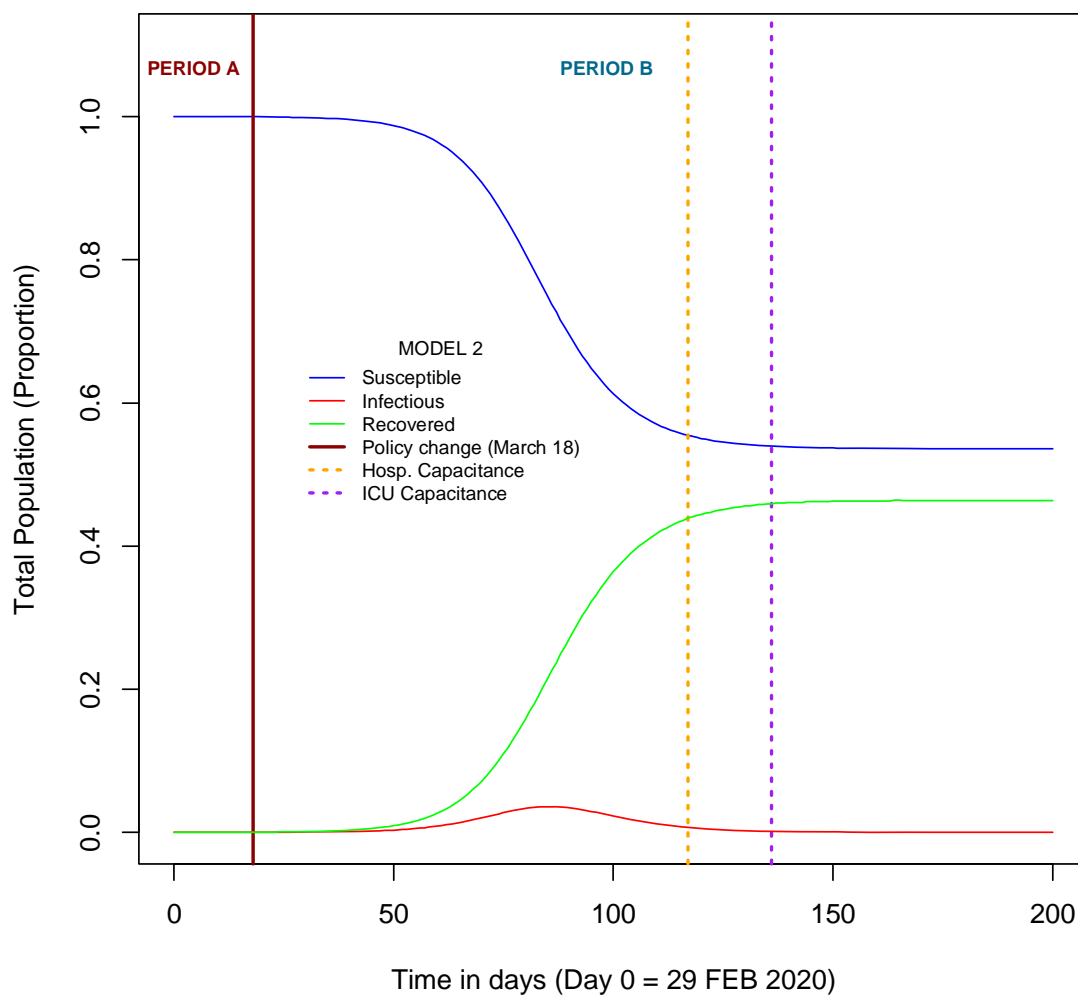

Figure 3B. MODEL 2: SIR-simulated COVID-19 outbreak in Ecuador, accounting for the start of containment measures.

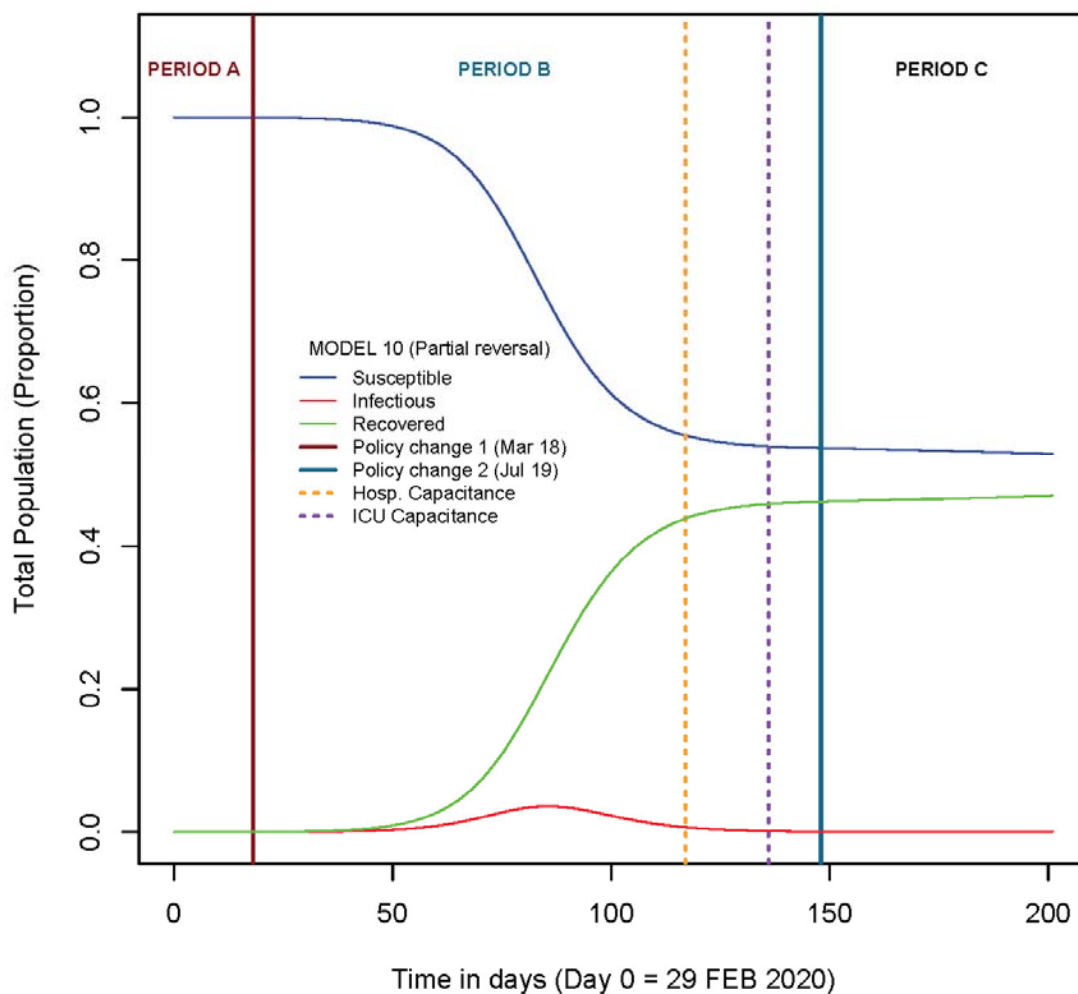

Figure 3C. MODEL 10: SIR-simulated COVID-19 outbreak in Ecuador if containment measures are partially reversed on July 19th, 2020. Solid lines represent period boundaries. Dashed lines represent time at which capacitance is reached.

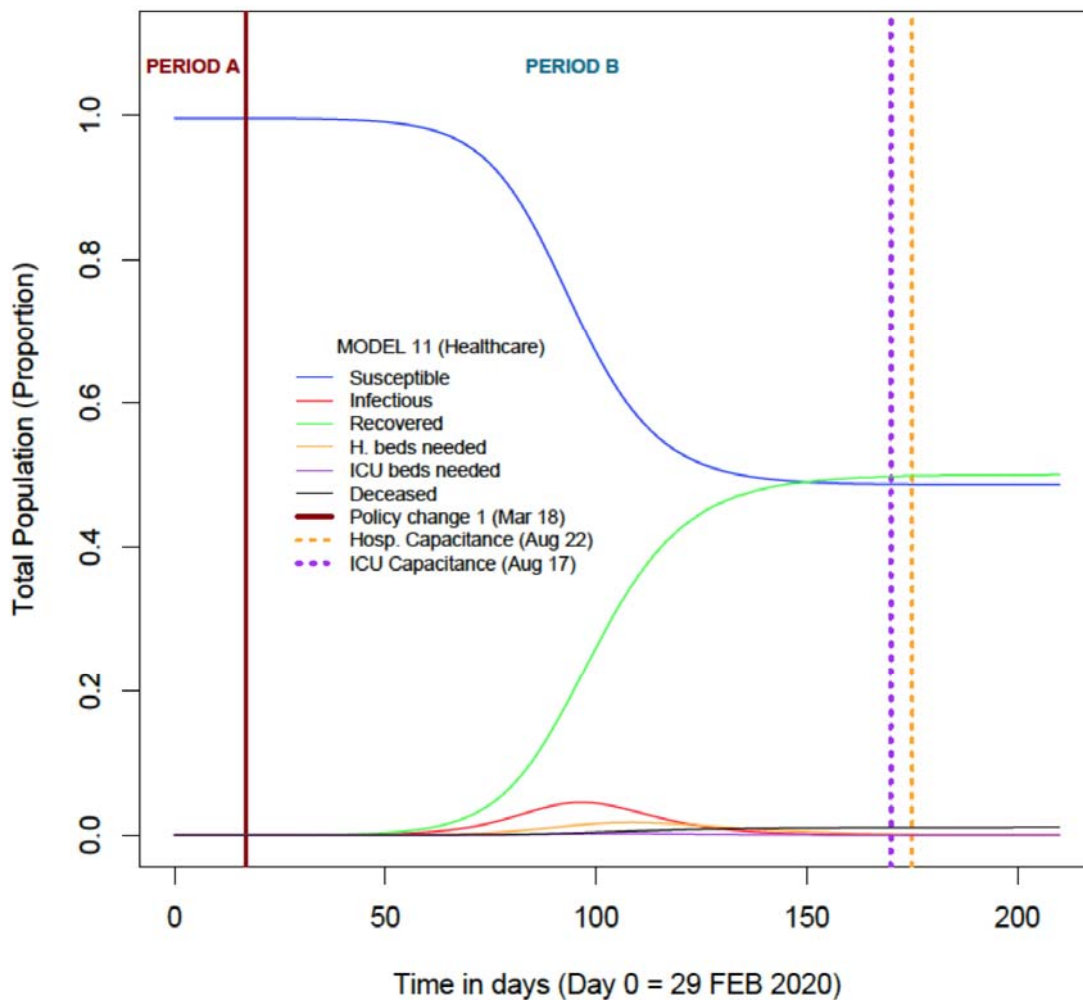

Figure 4A. MODEL 11: HeCEM-simulated COVID-19 outbreak in Ecuador. Solid line represents the time when containment measures were enacted. Dashed lines represent time at which capacitance is reached.

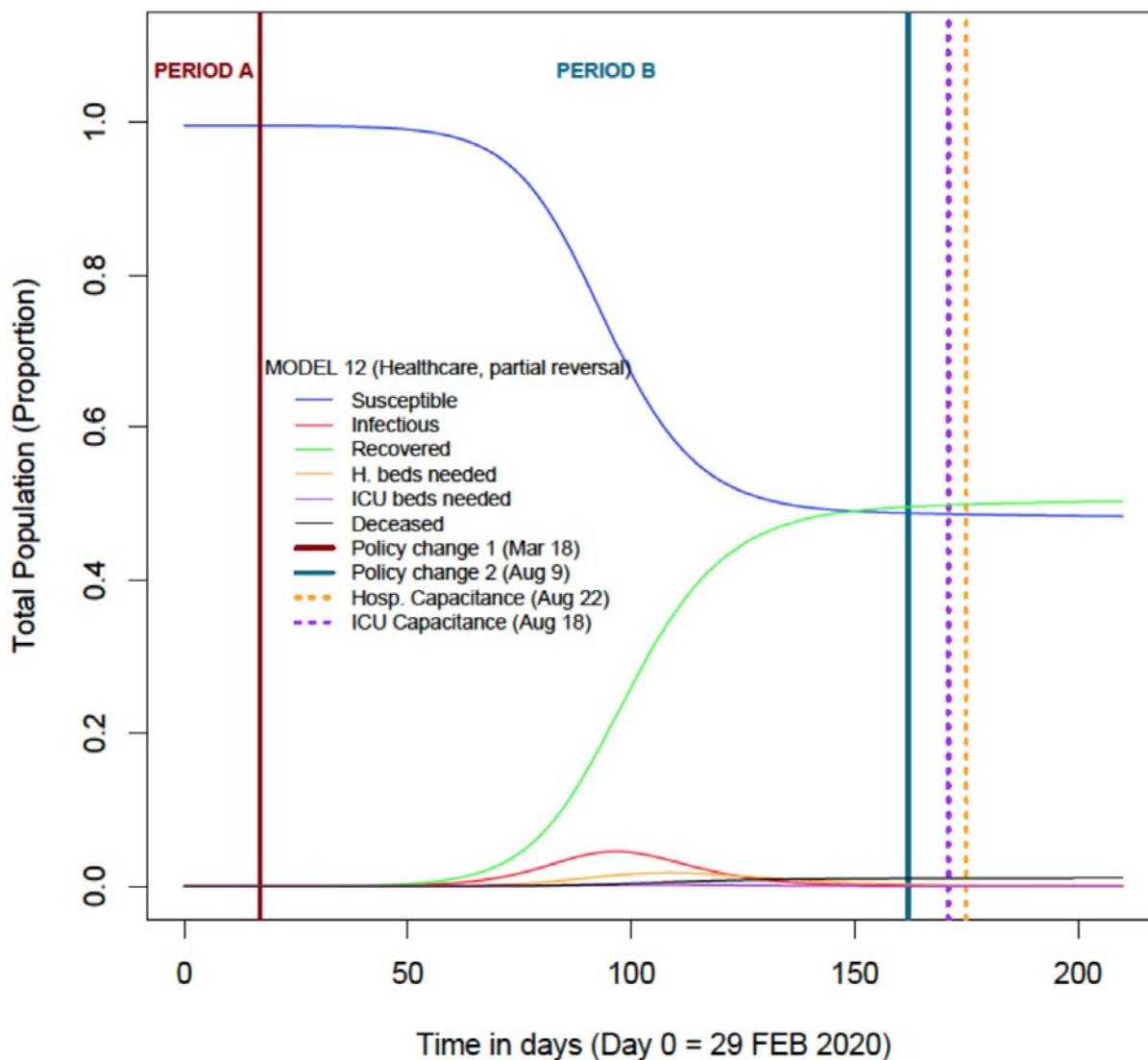

Figure 4B. MODEL 12: HeCEM-simulated COVID-19 outbreak in Ecuador assuming a partial reversal of containment measures on August 9th. Solid lines represent time when COVID-19 policies change. Dashed lines represent time at which capacitance is reached.

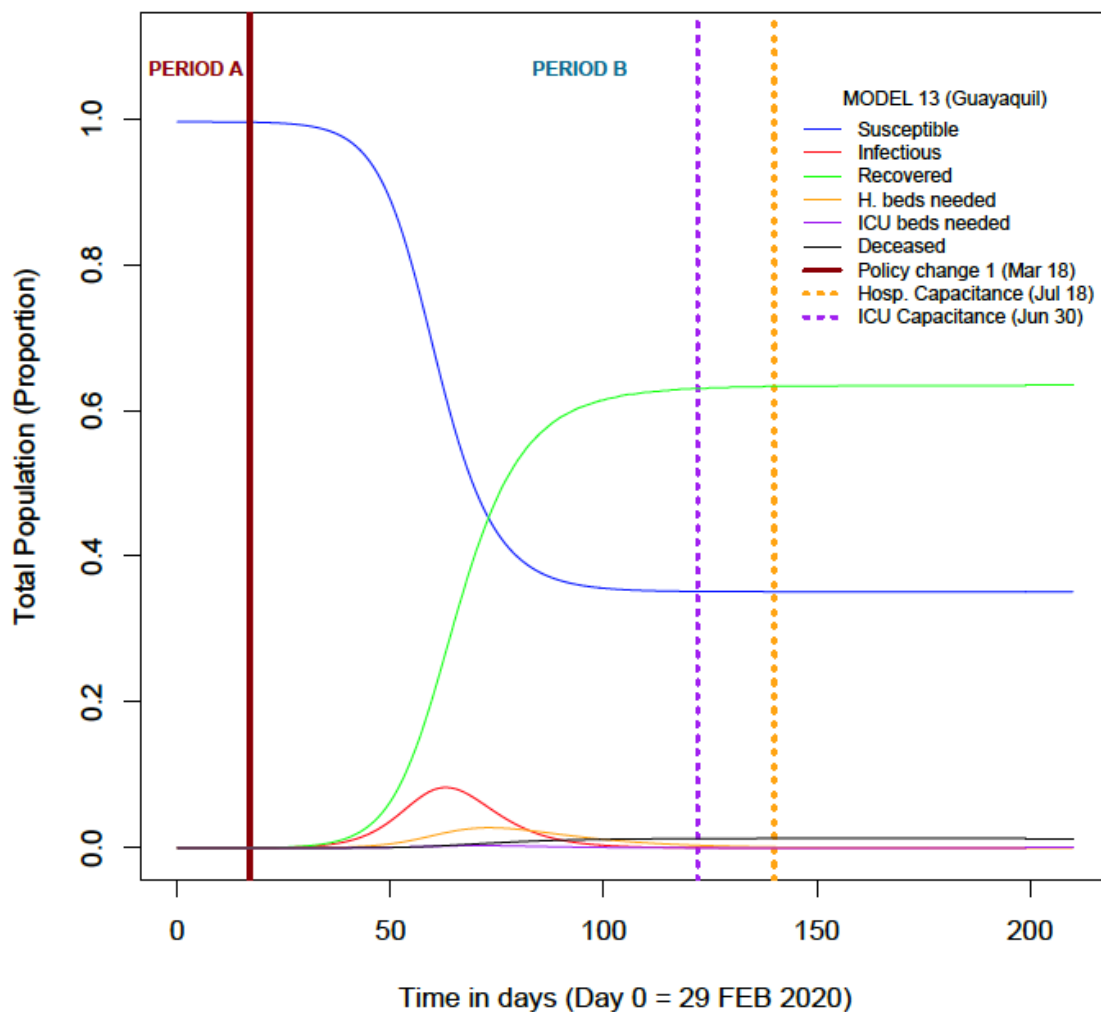

Figure 4C. MODEL 13: HeCEM-simulated COVID-19 outbreak in Guayaquil. Solid lines represent time when COVID-19 policies change. Dashed lines represent time at which capacitance is reached.

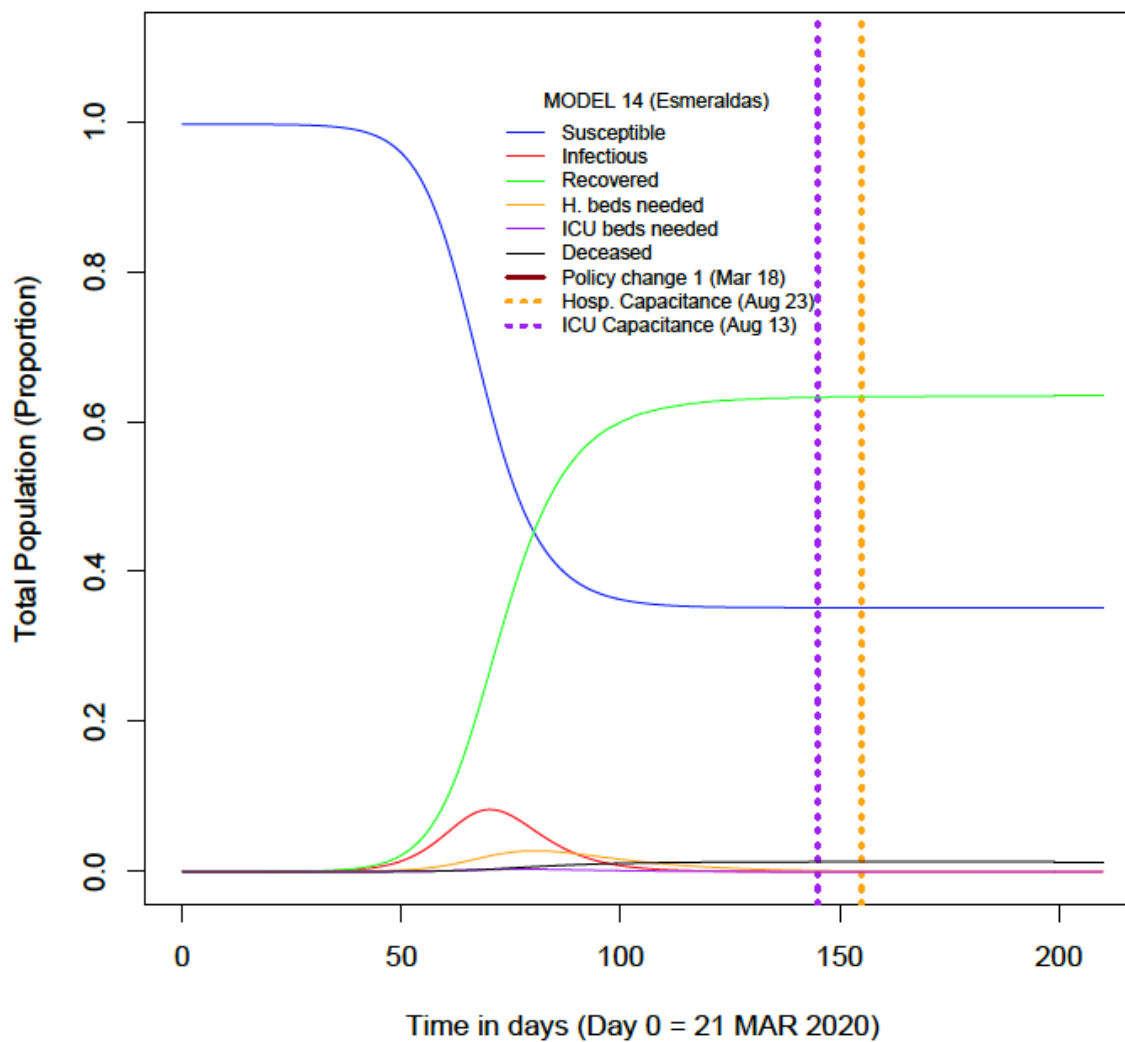

Figure 4D. MODEL 14: HeCEM-simulated COVID-19 outbreak in Esmeraldas. Dashed lines represent time at which capacitance is reached.

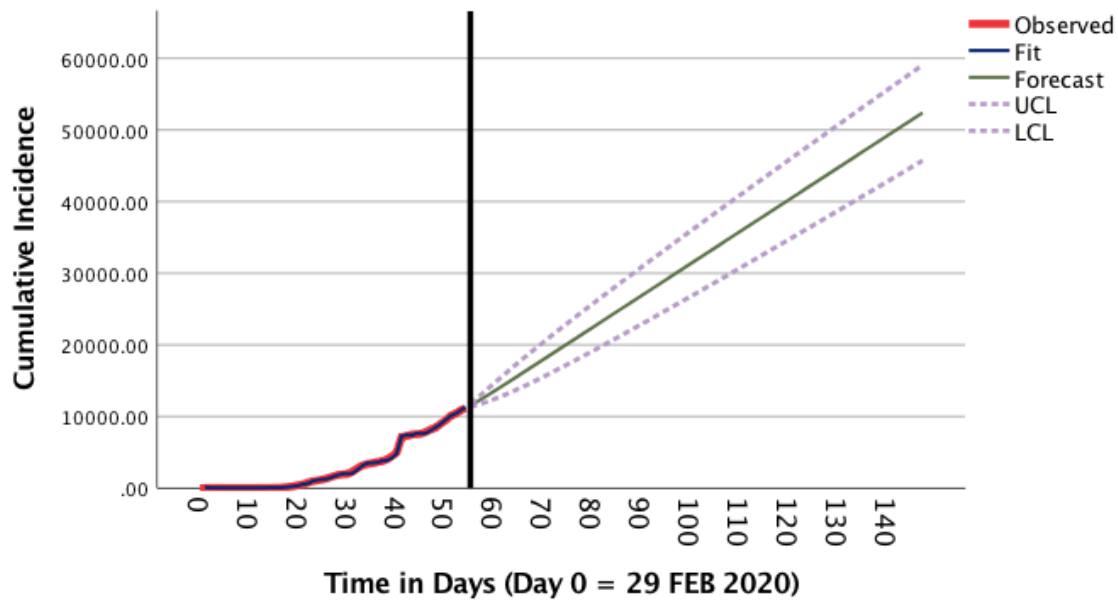

Figure 5. Forecast of COVID-19 cumulative reported incidence.

Table 1. Healthcare Compartmental Epidemic Model Parameters

| Parameter | Range | Period |
|---|--------------------------------------|----------------|
| Infectious Period (before containment measures) | -- | 3.48 days(13) |
| Infectious Period (after containment measures) | -- | 3.13 days(13) |
| Hospitalization ratio | 6.8%* (16)to 31.4%(15)** | 7 days(17, 18) |
| ICU admission ratio ⁺ | 32% | 3.5 days(18) |
| Case fatality ratio (CFR) | 1.4%(16) to 3.4%(15) [§] | 12.8 days(16) |
| CFR in ICU-admitted patients | 38%(18) | 7.3 days(16) |
| CFR in hospitalized patients | 4%(18) | 10.8 days(16) |
| Recovery ratio in ICU-admitted patients | 62%(18) | 17.7 days(16) |
| Recovery ratio in hospitalized patients | 96%(18) | 17.7 days(16) |

* Weighted average, ** Other estimates: 12.1%(17), 20.7%,(15) 14%(19).

⁺ among hospitalized patients.

[§] Other estimates: 1.8%(15)

CFR = Case Fatality Ratio; ICU = Intensive Care Unit